

NOMAD PRO 2™

Handheld X-ray System for Intraoral Radiographic Imaging



OPERATOR MANUAL

MANUFACTURED BY ARIBEX™

DO NOT OPERATE THIS DEVICE UNTIL YOU HAVE READ THIS MANUAL and reviewed the accompanying materials.

Disclaimer: NOMAD Pro 2 is sold with the understanding that the user assumes sole responsibility for radiation safety (as well as any state, provincial, or local regulatory compliance) and that Aribex, Inc., its agents or representatives, do not accept responsibility for:

- a) injury or danger to personnel from X-ray exposure,
- b) image over/under exposure due to poor operating techniques or procedures,
- c) equipment not properly serviced or maintained in accordance with instructions contained in this publication, and
- d) equipment which has been damaged, modified, or tampered with in any way.

Aribex and **NOMAD** are registered trademarks within the United States and other countries. **NOMAD Dental, NOMAD Pro, NOMAD Pro 2, PORTA-X**, and the ARIBEX and NOMAD logos are trademarks of Aribex, Inc. worldwide. Product protected in other countries by one or more issued patents. U.S. patents issued: 7,224,769 and 7,496,178. Other United States and international patents pending. All other brand and product names are trademarks or registered trademarks of their respective companies.

Further information about Aribex intellectual property available: www.aribex.com

The symbols used in this publication or used to mark the equipment have the following meanings:

















	<p>Ionizing Radiation</p>
	<p>Attention, consult instructions for use</p>
	<p>Recycling/instructions for handling product at end of life</p>
	<p>Dangerous Voltage, Electrical Shock Hazard</p>
	<p>Manufacturer of the device</p>
	<p>Date of device manufacture</p>
	<p>Model number or corresponding name</p>
	<p>Unique serial number for the device</p>
	<p>Reference to a radiation filter or a value of filtration</p>
	<p>Type BF Equipment (providing a degree of protection against electric shock, pertaining particularly to allowable leakage currents)</p>
	<p>Power supply positive/negative orientation</p>
	<p>Conformity marking indicating that product meets requirements to be sold in the European Union (EU)</p>
	<p>Marking indicating that product is compliant with certain North American safety standards</p>
	<p>Power button, used to power on/off device</p>
	<p>Audible signal, indicating audible cues emitted by device during operation</p>
	<p>Indicates manufacturer's authorized representative in the EU</p>

Table of Contents

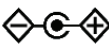
1.0	Getting Started	6
1.1	Intended Use/Indications for Use	6
1.2	Unpack, Check, and Register NOMAD Pro 2 System	6
1.3	Charging the Handsets	6
2.0	Safety Precautions	8
2.1	Radiation Safety	8
2.2	Studies and Data on Leakage and Scatter	10
2.3	Usage and Duty Cycle	12
2.4	Cleaning	13
2.5	Security, Storage, and Transportation	13
3.0	Setup and Power Check	15
3.1	The Backscatter Shield	15
3.2	Attaching a Charged Handset	15
3.3	Checking for Power	15
3.4	Optional Checks	16
4.0	Operation	17
4.1	Powering Up	17
4.2	Lock/Unlock the X-ray	17
4.3	Ensuring the Right Exposure Time is Set	17
4.4	Ready the Device	18
4.5	Initiating and Completing an X-ray Exposure	19
4.6	Powering Off	19
4.7	Exposure Techniques	20
4.8	Assuring Image Quality	21
4.9	Technique Factors Settings and Adjustments	22
4.10	Settings Menu	23
5.0	Handset Replacement and Care	25
6.0	NOMAD Pro 2 Care and Upkeep	26
6.1	Alarms and Alerts	26
6.2	Troubleshooting	29
7.0	Maintenance and Repair	31
7.1	Maintenance Schedule	31
7.2	Optional Calibration Checks	33
7.3	Maintenance Log Sheets	34
7.4	Repair	35
8.0	Technical Description	36
8.1	Basic Technical Specifications	36
8.2	X-ray Tube Specifications and Characteristics	38
8.3	EMC Data	41
8.4	Limited Warranty	43

Thank you for choosing the Aribex NOMAD Pro 2 as your X-ray solution!

At Aribex we value your business and we would like to hear from you because your feedback and suggestions are important to us. If you have comments, please email us: support@aribex.com

NOMAD Pro 2 Features:

- **Performance** – Battery power source delivers dependable high voltage (60kV, true DC) and direct current (2.5mA).
- **Consistent Emission Radiation** – High-frequency, constant-potential X-ray generator provides high quality images, with a lower radiation dosage to the patient than standard AC X-ray systems. (See *Compendium Report, May 1993, Vol. XIV, No. 5, "X-Radiation: Potential Risks and Dose Reduction Mechanisms."*)
- **Radiation Protection** – Operator shielded from source and backscatter radiation.
- **Simple Operation** – By selecting patient size, receptor type and tooth type, the factory pre-set exposure time is digitally displayed on the user-friendly control panel along with indicators for machine and battery status.
- **Lightweight and Ergonomic** – Design provides complete flexibility and convenience, enabling exposures without moving the patient to the X-ray source.
- **Exposure Safety Feature** – Cannot emit X-rays with insufficient voltage (low battery).
- **Engineered for Compatibility** – Works with film, digital, and phosphor plate imaging systems.
- **Infrared Communication** – IR technology used to facilitate reliable communication between device head, battery handset, and charging cradle.
- **Authorized Service** – Complete support and maintenance from Aribex and through our authorized distributors.
- **X-ray Locking Feature** – Enables the safe training, demonstration, and storage of the device without undue concern related to unintended or unauthorized radiation emission.
- **Two Product Color Options** – Black body with gray accents, in addition to standard color scheme, offers a variety of choices for complementing office décor.

1.0 Getting Started

1.1 Intended Use/Indications for Use

The NOMAD Pro 2 X-ray System is designed to be used for both adult and pediatric patients by trained dentists and dental professionals for producing diagnostic dental X-ray images.



Caution: U.S. Federal law restricts this device to sale by or on the order of a physician or other licensed practitioner.

1.2 Unpack, Check, and Register NOMAD Pro 2 System

❶ Unwrap individual components from the protective plastic and check for any noticeable signs of damage. The package system includes the following items:

- NOMAD Pro 2 Device
- 2 Handsets (0.850.0087 for standard, 0.850.0088 for black)
- Charging Cradle and the AC/DC Power Supply (0.850.0102 for standard, 0.850.0103 for black; other cord sets available upon request)
- Certificate of Conformance, Getting Started Guide, Warranty/Registration Card, and NOMAD Pro 2 Operator Training CD

❷ Preliminary Checks:

Item	Check
Device Labels	Verify that the serialized device label is in place (located on lower side of unit).
Other Labels	Verify that the serial number on the warranty/registration card matches the device serial number on the device and the device serial number on the carrying case. Verify that the handsets' label (located on the top of each handset) and the charging cradle label (located on the bottom of the charging cradle) are all in place.
Collimator Cone and Backscatter Shield	These two items provide operator protection and should be inspected for shipping damage.
Trigger Switch	Should freely move in and out when depressed and released.
Device Housing	Should be free of cracks or fractures.

❸ Complete the product warranty/registration card and mail it with proper postage to Aribex today. Completing the card fulfills a condition of warranty coverage (see [Section 8.4 Limited Warranty](#)) and enables you to receive valuable product news and updates.

1.3 Charging the Handsets



- Handsets must be charged before initial use! Alternate handsets each week to maximize service life.
- Do not spray disinfectant or cleansers directly on to the handsets!

It is recommended to fully recharge handsets every three months while in long-term storage to ensure that no low battery becomes damaged.

① Use only the supplied AC/DC power supply (or other Aribex-supplied cord set). Unwrap the power cord of the power supply and connect it to the charging cradle, then to an AC electrical outlet (universal voltage accommodated). The single green circle on the charging indicator will illuminate green if there is adequate power to the charging cradle. If the green circle does not illuminate, the charging cradle is not receiving adequate power and may need to be sent to an Aribex authorized service center for repairs.



Receiving adequate power

Position the charging cradle away from the normal patient environment. A plug adapter may be needed to accommodate the local AC configuration.

② Invert one of the handsets and carefully slide it onto the charging cradle (do not force the handset onto the charging cradle or damage may result). Expect charge time to be less than three hours. The handset, charging cradle, and AC power supply may become warm to the touch while charging.

③ When the handset is first slid onto the charging cradle, the first bar will illuminate green for approximately two seconds to indicate that the cradle and handset are communicating. If the first bar illuminates green, but then all of the bars illuminate red, the charging cradle and/or handset will need to be sent to an Aribex authorized service center for repairs. Authorized service will also be required if no illumination occurs upon sliding the handset onto the charging cradle.



Contact Aribex for service

④ After illuminating green, the first bar will begin flashing to indicate that charging has begun. When the first bar turns solid green, the handset is 1/3 charged, and the second bar will begin flashing green. When the second bar turns solid green, the handset is 2/3 charged, and the third bar will begin flashing green. Once the third bar turns solid green, the handset is fully charged. **Remove the handset from the charging cradle once it is fully charged.**



Handset 1/3 charged

Handset 2/3 charged

Handset fully charged

2.0 Safety Precautions

2.1 Radiation Safety

The NOMAD Pro 2 was designed to be used in both clinical settings (e.g., a dental office) and controlled settings where transportation or use of other X-ray devices might be prohibitive due to the device's size and/or mobility.



This X-ray unit may be dangerous to patient and operator unless safe exposure factors, operating instructions, and maintenance schedules are observed.



This X-ray unit must only be operated by trained personnel in a controlled setting. Within such a setting, ensure that only the patient is in the direct beam of the x-ray, and that any ancillary personnel are a minimum of 6 feet away from the patient. If it is necessary for any ancillary personnel to be closer than 6 feet, these personnel should stay out of the direct beam and wear personal protective equipment, such as an apron and thyroid collar.



- The NOMAD Pro 2 provides a high degree of protection from unnecessary radiation. However, no practical design can provide complete protection nor prevent operators from exposing themselves or others to unnecessary radiation. It is important to restrict use and follow all applicable government radiation protection regulations. Pregnant women should not be exposed to X-rays unless necessary. Proper safety precautions should be taken to minimize dose to the fetus.
- Operators must be fully acquainted with industry safety recommendations, established maximum permissible doses, and local jurisdiction requirements for use.
- Optimal operator protection from radiation backscatter exists when the following measures are taken:
 - a) the backscatter shield is positioned at the outer end of the collimator cone,
 - b) the backscatter shield is close to the patient,
 - c) the patient tilts his or her head when needed to accommodate exposures (see [Section 4.7 Exposure Techniques](#)), and
 - d) the operator remains within the significant zone of occupancy immediately behind the device shield.

- Do not enable the NOMAD Pro 2 until patient and operator are positioned and ready for the exposure, preventing interruption and inadvertent exposure of anyone to X-rays.
- Do not attempt an exposure if anyone other than the patient is in the direct beam. If others are assisting, then they should wear protective covering as required by local jurisdictions. An apron and thyroid collar are recommended for ancillary personnel who are closer than 6 feet to the patient.
- When selecting and using sensors, preference should be given to models that allow the backscatter shield to remain at the outer end of the collimator cone for maximum operator protection.
- An exposure can be terminated for any reason by prematurely releasing the depressed trigger (for more information, see [Section 4.0 Operation](#)).
- As shown in graphic representations, maximum protection (green area) from backscatter radiation (red area) exists when the NOMAD Pro 2 is positioned near the patient, is perpendicular to the operator (with the patient’s head tilted if needed), and the backscatter shield is fully extended toward the patient and parallel to the operator.

Stay in the ZONE				
	Proper Position	Held Back	Shield slid back	Non-perpendicular
PROTECTION:	MAXIMUM	MINIMIZED		

- Operation outside the protection zone (or with a diminished protection zone) requires proper precautions such as the use of an apron and thyroid collar, according to requirements of local jurisdictions.
- **Do not operate if the backscatter shield or collimator cone is broken!**
- For further information on the tests performed to ensure NOMAD Pro 2 safety as a handheld device, please see [Section 2.2 Studies and Data on Leakage and Scatter](#).



In implementing a radiation protection program, consult all applicable regulations governing radiation protection and the use of X-ray equipment, and ensure full compliance with any such regulations.

2.2 Studies and Data on Leakage and Scatter

Besides direct beam, potential exposure from X-ray devices has only two other possibilities:

- 1) leakage radiation and
- 2) scatter radiation from the patient/subject in the direct beam.

Leakage

Unique internal shielding of NOMAD Pro 2 encases the X-ray tube, practically eliminating leakage radiation. This makes it safe to use Pro 2 as a handheld device during exposures. As demonstrated by Chart 1, NOMAD Pro 2 hand and extremity annual levels are less than 0.1% of the annual occupational dose limit.

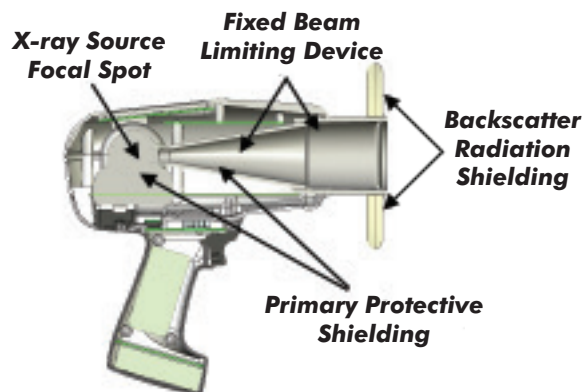

CHART 1: Comparative Data for Hand and Extremity Exposure (Annual)

500mSv	Occupational Dose Limit ¹
50mSv	Occupational Dose Limit Requiring Dosimetry ¹
0.43mSv	Average Exposure Using NOMAD with D-Speed Film ²
0.22mSv	Average Exposure Using NOMAD with F-Speed Film or Digital Sensor ²

1) Standards for Protection against Radiation, 10 CFR 20 (US Federal Standards), 1994. See also *NCRP Report No. 116 and Suggested State Regulations for Control of Radiation D.1201*.
 2) "Radiation Exposure with the NOMAD Portable X-ray System," Goren AD et al, *Dentomaxillofacial Radiology*, 37 (2008), S.109-12; normalized average (includes leakage and backscatter radiation) assumes 7,200 exposures per year, and the average length of exposure for D-speed = 0.50 seconds, F-speed = 0.25 seconds, digital sensor = 0.20 seconds.

FDA regulations specify that leakage radiation from X-ray devices not exceed 0.88mGy/hr, while IEC regulations stipulate that devices stay below 0.25mGy/hr, an even tighter limit. In response to these regulations, Aribex will only ship product that tests below 0.02mGy/hr for leakage, a self-imposed requirement 44 times more stringent than FDA regulations and 12.5 times more stringent than IEC regulations.

In order to verify compliance with this leakage requirement, each individual device is tested with a calibrated survey meter at 12 points on the device housing, as shown in the following diagram. The highest measurement out of these 12 points is reported on the device Certificate of Conformance (which is shipped with every device) and must be lower than 0.02mGy/hr in order for the device to successfully pass product release testing.

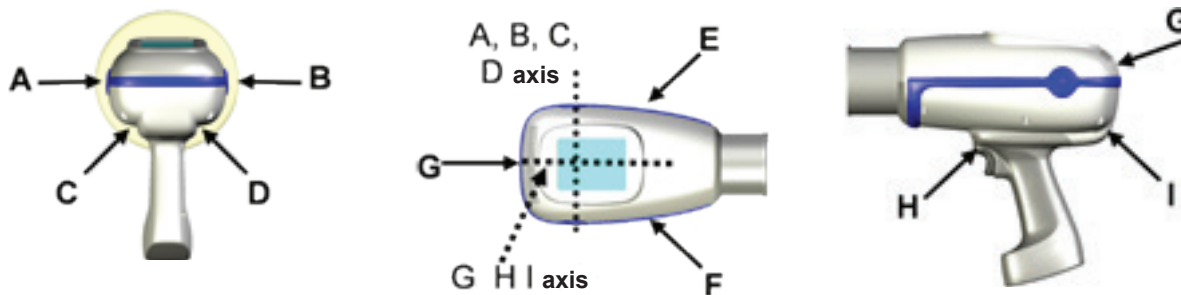

Test points for product release testing

Scatter

As discussed in Section 2.1 Radiation Safety, the transparent shield on the NOMAD Pro 2 collimator, when properly oriented, acts as a barrier against backscatter radiation, making it safe for the operator to stay in the room. As demonstrated by Chart 2, NOMAD Pro 2 whole body annual levels are less than 0.6% of the annual occupational dose limit.

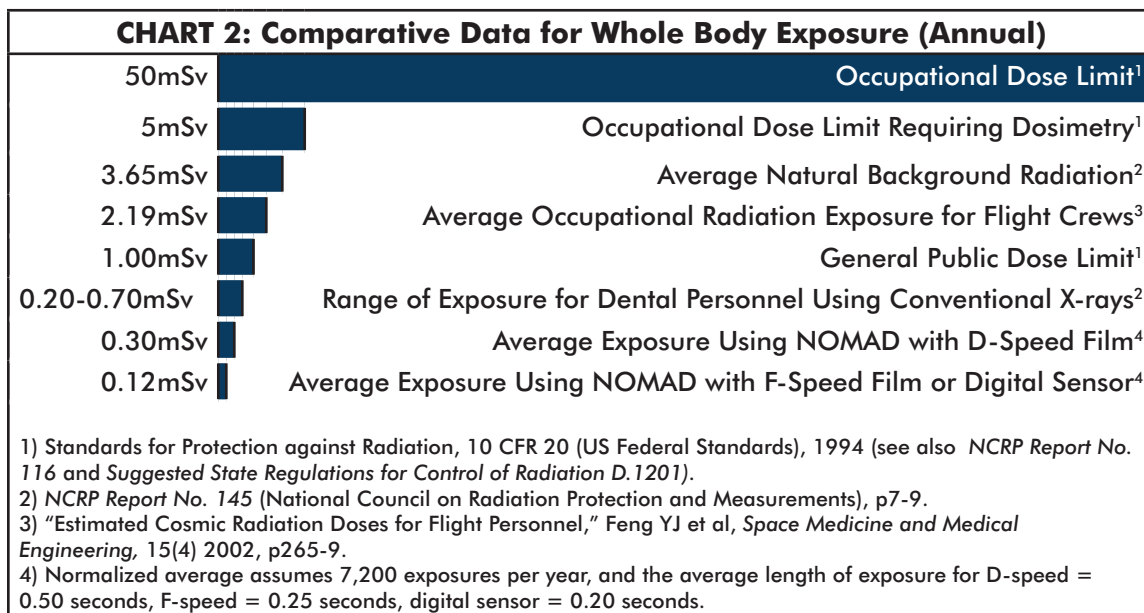

The significant zone of occupancy for operators has been further verified by internal testing. A NOMAD device was remotely fired into a water phantom repeatedly, with an ion chamber recording radiation readings at 336 points in the room, first to establish the vertical significant zone of occupancy and then to establish the horizontal significant zone of occupancy. Each exposure was taken at 1.00 seconds in order to simulate "worst case scenario" results. As seen in the following graphed information, the vertical significant zone of occupancy measures 60 cm X 200 cm, while the horizontal significant zone of occupancy is 60 cm X 60 cm.

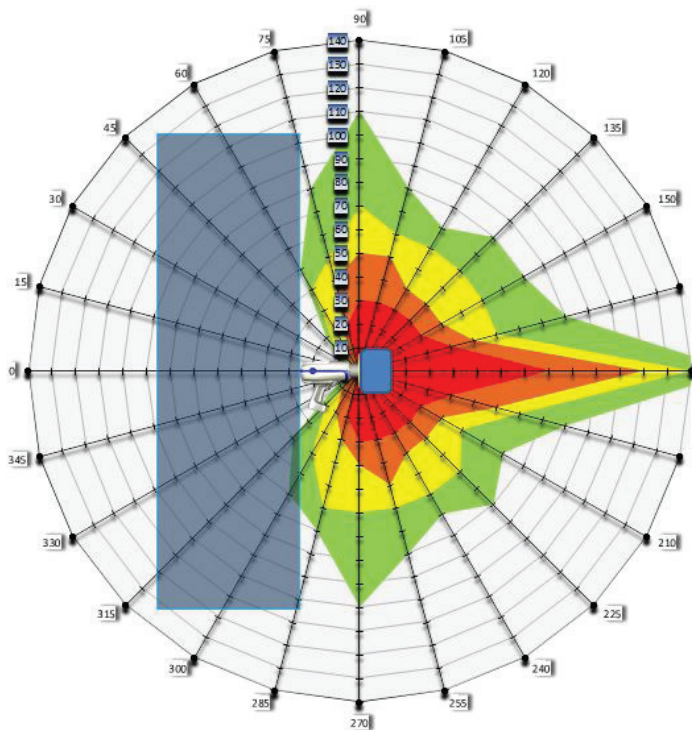

Vertical Plane, Significant Zone of Occupancy: 60 cm x 200 cm

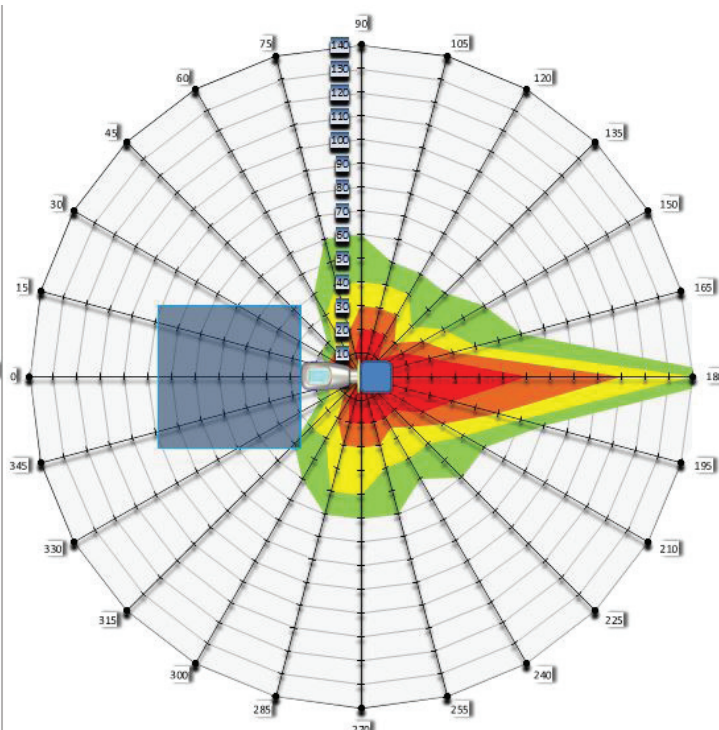

Horizontal Plane, Significant Zone of Occupancy: 60 cm x 60 cm

For further information on these tests, please contact Aribex.

Handheld as Safe as Wall Mount?

Due to the design of the NOMAD, operators using the device tend to experience an average monthly radiation dose about 28 times lower than that of operators using wall-mounted systems.¹ Not only is the NOMAD as safe as a wall-mount device, in some cases it appears to be even safer.

2.3 Usage and Duty Cycle

As a safety feature, the NOMAD Pro 2 will not emit X-rays with insufficient voltage (low battery).

The NOMAD Pro 2 is also designed to avoid damage from overheating. The minimum duty cycle rating for maximum exposure (the relationship between duration and frequency of exposures taken during a rolling 60 second period) is 1:60. This duty cycle is programmed into your NOMAD Pro 2. The following table shows examples of optimal use:

Exposure Duration	0.09 sec	0.20 sec	0.40 sec	1.00 sec
Hypothetical Time Between Exposures	6 seconds	12 seconds	24 seconds	60 seconds
Exposures Per Minute	>10	>8	>2	1

¹ "Dental Staff Doses With Handheld Dental Introral X-ray Units," JE Gray, ED Baily, JB Ludlow, *Health Physics Society* 102.2 (2012), P. 137-142.



Do not operate the NOMAD Pro 2, the handset, charging cradle, or AC power supply if equipment was subjected to moisture (wetting, immersing, or soaking). Return to Aribex or authorized service center for service.



- Do not open the housings. Doing so will void the warranty. There are no user serviceable parts inside the NOMAD Pro 2, handset, charging cradle, or AC power supply.



- The NOMAD Pro 2 should not be used in environments where flammable cleaning agents are present.
- Locate the charging cradle away from the normal patient environment.

2.4 Cleaning

- 1 Use a **non-acetone** based disinfectant wipe (with less than 17% alcohol content) or a cloth to wipe the exterior surfaces of the NOMAD Pro 2 and charger. Do not use cleaners intended for hard surfaces, since certain chemical combinations may deteriorate the NOMAD Pro 2 plastic prematurely.

- 2 Leave the handset connected to the NOMAD Pro 2 and wipe down all surfaces of the device.

- 3 Unplug the charging cradle before cleaning.

NOTE: The NOMAD Pro 2, the handsets, the charging cradle, and the AC power supply are not designed to be subjected to any kind of sterilization procedure.



Do not spray disinfectant or cleaners directly on the NOMAD Pro 2, handsets, charging cradle, or AC power supply. The connecting areas are open to ingress and damage to your device may result.

2.5 Security, Storage, and Transportation

- Do not store the NOMAD Pro 2, handsets, charging cradle, or AC power supply in extreme conditions: below -20°C or above $+60^{\circ}\text{C}$, or beyond 95% relative humidity (non-condensing). The optimal storage location is cool, dry, and away from direct sunlight.
- Aribex recommends that the NOMAD Pro 2 (like all electronic equipment) be allowed to acclimate before use when switching between temperature extremes (i.e., cold storage area to a warm use area or hot storage area to a cool use area).
- When finished for the day with the NOMAD Pro 2, detach the handset.
- The **X-ray Lock** and **Unlock** (Section 4.2) serves as the device security key to prevent unauthorized use. In addition, it is recommended that the device be locked away when not in use. For a further level of security, securely store handsets in a separate location.
- Take steps to ensure the NOMAD Pro 2 will not be knocked to the ground when not in use. Lay it on its top, side, or in the accessory tabletop stand (0.850.0037). Power will automatically shut off after a period of inactivity (approximately three minutes).

-
- Some battery charge may be lost during extended inactivity (leading to fewer exposures between handset charging cycles).



- The NOMAD Pro 2 should not be operated if it has been dropped or if performance degrades; it should be returned to Aribex or an authorized service center for an evaluation.
- When finished for the day with the NOMAD Pro 2, detach the handset.
- For long-term storage, it is recommended to fully recharge the handsets every three months.

3.0 Setup and Power Check

3.1 The Backscatter Shield

In addition to the radiation shielded cone, the backscatter shield provides additional protection to the operator and can be adjusted to permit exposures made at various angles.

❶ Ideally, the shield should remain fully extended to the outer edge of the cone, as close to the patient as possible during each image taken (see [Section 2.1 Radiation Safety](#)).

❷ You may find that the backscatter shield needs to be adjusted to accommodate sensors or angled exposures. If adjustments are needed, gently glide the shield up or down along the cone using equal pressure to maintain a perpendicular alignment and to avoid binding.



❸ To keep the shield securely on the cone, a cap is permanently attached at the outer cone end. Do not attempt to remove this cap or to remove the backscatter shield. Attempting to do so will result in damage to your device and void the warranty.

3.2 Attaching a Charged Handset

❶ With the NOMAD Pro 2 placed bottom up on a secure surface, properly orient and carefully slide the charged handset onto the base of the NOMAD Pro 2. (A properly oriented handset should click into place with firm pressure.)

❷ The clicking sound ensures the locking mechanism has secured the NOMAD Pro 2 to the handset. To verify this lock, apply slight pressure in the release direction.

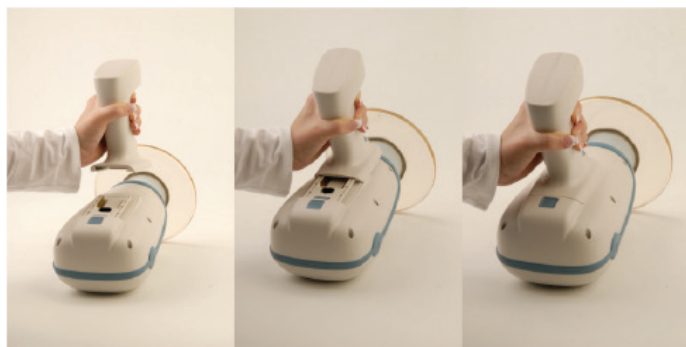

There are electric voltages present at the handset terminals. Protect the handset from damage; do not probe with fingers or conductive objects.

3.3 Checking for Power

❶ After locking a handset in place press the **Power**  button.

❷ The display panel will activate with a battery power level icon in the upper right corner. Five bars is an indication of a fully charged handset.

③ If the battery charge is too low, the NOMAD Pro 2 will not emit an X-ray and the **Recharge Handset** alarm will display.

④ When a battery is depleted to the single bar level  it is recommended the handset be recharged. **Remove the handset from the charging cradle once it is fully charged.**

⑤ Replace a low charge handset with the secondary handset (which should be charged in advance). It is recommended that you keep one handset fully charged at all times to ensure continuous operation.

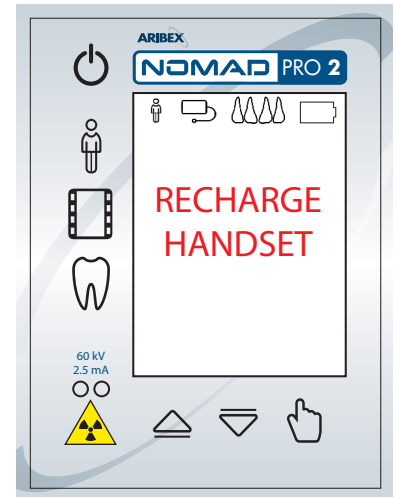

Recharge Handset Alarm





3.4 Optional Checks

The NOMAD Pro 2 is factory calibrated and tested prior to release (see your Certificate of Conformance). A self-diagnostic is completed each time an exposure is taken.

However, the optional checks listed below may be performed periodically as desired. Some locations may require initial and periodic checks as a condition of use.



The NOMAD Pro 2 has an X-ray disable feature that allows the X-rays to be disabled for training purposes. Test firing this X-ray unit may otherwise be dangerous to the testing technician or bystanders. See [Section 4.2](#) for more information.

- **Power On/Off:** Attach a fully charged handset to the NOMAD Pro 2 device. Press the **Power**  button and verify that the device correctly powers on and off.
- **Increase/Decrease Exposure Time:** With the device on, select the patient size, the image receptor type, and the tooth type. The exposure time corresponding to the selections will display on-screen. Press the **Increase**  and the **Decrease**  buttons, and verify that the exposure time changes appropriately. When the **Increase**  or **Decrease**  buttons are pressed and held, the rate at which the displayed time setting changes on screen accelerates.
- **Triggering:** With the device on and an exposure time selected, press and release the trigger once. This will ready the device, and the display will indicate the **Ready** state. To end the **Ready** state, press any button on the user interface panel or wait approximately 15 seconds for the timeout.
- **Automatic Shut-down:** With the device on, allow approximately three minutes of inactivity to pass for the system to automatically shut down.



The NOMAD Pro 2 should not be operated if it has been dropped or if performance degrades; it should be returned to Aribex or an authorized service center for an evaluation.

(See [Section 6.1 Alarms and Alerts](#) for more information.)

4.0 Operation

4.1 Powering Up

NOTE: The manufacturer's recommendation is for the operator to wear nitrile or other gloves during basic operation of the NOMAD Pro 2.

Press and release the **Power**  button to turn on NOMAD Pro 2. An audible double tone and an active display panel indicate the device has power.



Technique factors are redisplayed according to what was displayed when the device was turned off, along with the last saved time setting.

4.2 Lock/Unlock the X-ray

The X-ray lock and unlock functionality can be activated to prevent unauthorized use when the NOMAD Pro 2 is idle or stored. This functionality may also be used for training purposes.

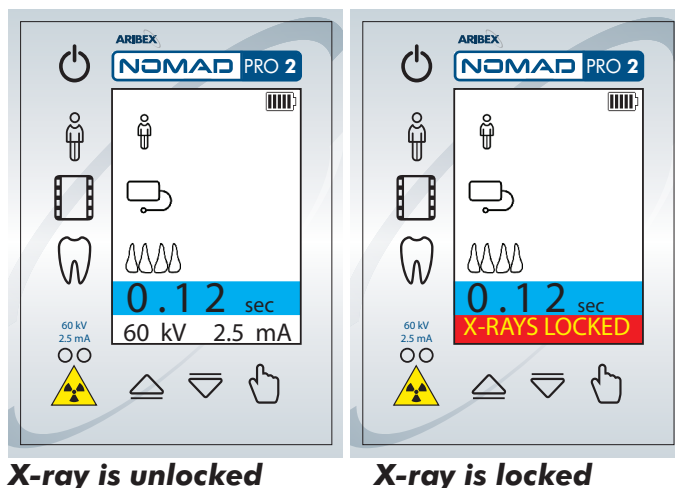
To lock the X-ray, first press and hold the **Select**  button while pressing the **Patient** button. The device shifts into an **X-rays Locked** state, and the buttons can be released. Repeat the process to unlock the X-ray device.



NOTE: If the **Select**  button is held down for longer than 3 seconds before the **Patient** button is pressed, the Menu mode will activate; if the **Select**  button is pressed and released before the **Patient** button is pressed, the Save menu is displayed.

4.3 Ensuring the Right Exposure Time is Set

When power is turned off, the most recent setting for the exposure time is stored in the memory and redisplayed when power is turned back on. However, if the battery is replaced, the display is reset to the default value.

To change exposure settings press each of the buttons to toggle through the choices:

- 1) the **Patient Size** (adult or child)
- 2) the **Image Receptor** (film, phosphor plate, or sensor)
- 3) the **Tooth Group** (anterior, posterior, or bitewing)

Examples from factory default settings:

Child, Sensor, and Anterior = 0.09sec

Adult, Film, and Posterior = 0.38sec

When necessary, use the **Increase** or **Decrease** buttons to adjust the time in 0.01 second increments. Adjusted exposure settings may be saved, replacing factory settings (see Section 4.9 Technique Factors Settings and Adjustments).

4.4 Ready the Device

To prevent accidental radiation exposure, properly position the patient and operator before readying the NOMAD Pro 2.

Press and release the trigger once to ready the device. The device will briefly display an **Enabling X-rays** message before indicating **Ready**.

NOTE: As a safety precaution, if the trigger is held longer than one second or pulled a second time while still in the **Enabling X-rays** state, the device will not transition to the **Ready** state. (This is to prevent an accidental activation of the device by unintended triggering.)

The illuminated green LED, the message **Ready** on the display panel, and a double tone alert confirm that NOMAD Pro 2 is prepared to fire X-rays. The **Ready** state continues until either an exposure is initiated or timeout occurs after 15 seconds of inactivity (accompanied by a double tone and the return to the at-rest state).

While the device is in the **Ready** state, any changes to the settings (pressing any user interface panel button) will end the state.

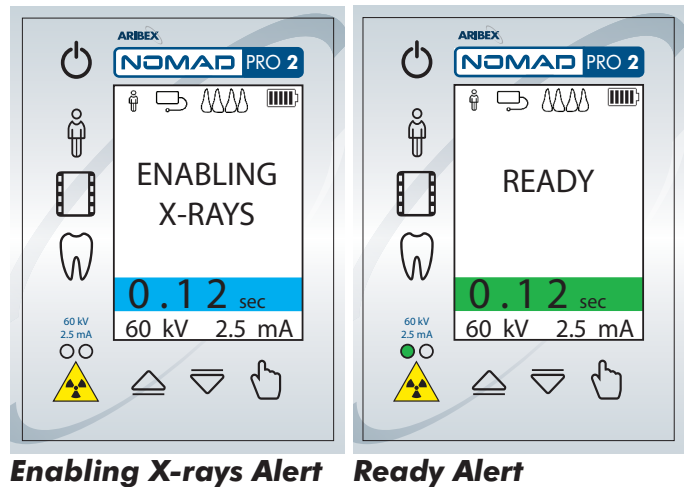

4.5 Initiating and Completing an X-ray Exposure

To begin the exposure, press and hold the trigger. The **Ready** alert is replaced with the **X-rays On** alert, the green LED is replaced with a yellow LED, and there is an alert tone for the duration of the exposure.

To ensure complete exposure, keep the trigger depressed until the audible tone is complete, the yellow LED is off, and the **X-ray Complete** alert briefly displays. The device then returns to the at-rest state.

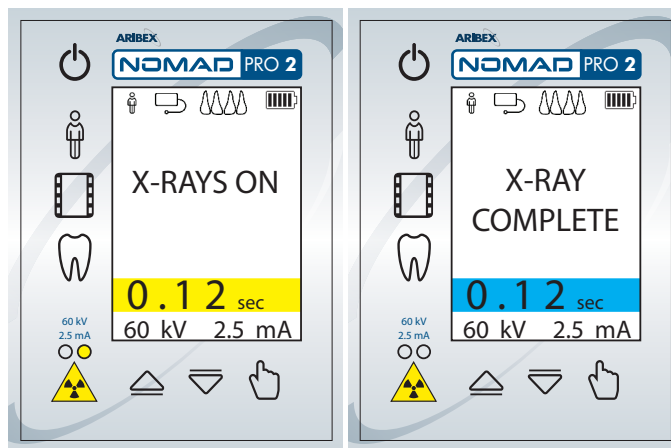

X-rays On Alert

X-ray Complete Alert

NOTE: An exposure can be terminated for any reason by prematurely releasing the depressed trigger.

4.6 Powering Off

Press and release the **Power**  button to turn NOMAD Pro 2 off.

The NOMAD Pro 2 also automatically shuts off after approximately three minutes of inactivity.

The NOMAD Pro 2 display darkens, accompanied by a tone to indicate shut-down.

4.7 Exposure Techniques

As an intra-oral dental X-ray system, the NOMAD Pro 2 can be easily positioned. This high degree of flexibility makes it easy to take exposures while the patient is reclined, lying completely on their back, or sitting upright. Ensure the patient is protected by using an apron.

- 1 When taking images, operators may hold the NOMAD Pro 2 by having both hands on the handset grip, or, for increased stability and patient safety, by placing one on the grip and the other on the underside of the housing (but not on the collimator cone).
- 2 Position the NOMAD Pro 2 relative to the imaging system to minimize cone-cutting. (If your practice uses film holding kits or aiming devices, check compatibility in advance.)
- 3 Exposure times increase proportionally when the imaging angles vary away from 90° (or perpendicular) to the film or sensor. To maintain low patient X-ray doses and to keep the operator within the protection zone, have the head of the patient slightly tilted, and/or raise or lower the chin as needed. (See [Section 2.1 Radiation Safety](#).)
- 4 When the device must be angled and the operator cannot be completely within the protection zone, ensure operator protection through the use of proper safety measures, such as the use of an apron. (See [Section 2.1 Radiation Safety](#).)
- 5 Avoid touching the patient with the cone or backscatter shield; disposable plastic coverings can be used to prevent cross-contamination.
- 6 Determine what NOMAD Pro 2 exposure time settings deliver optimal results for the type of imaging (digital or film-based) that is used on a regular basis.

NOTE: Both digital imaging sensors and film and phosphor plate speeds can vary somewhat in their characteristics and could require different exposure settings to meet density preference. (See [Section 4.10 Settings Menu](#) for more information.)



4.8 Assuring Image Quality

The following NOMAD Pro 2 features contribute to high image quality:

- DC voltage X-ray generation is efficient in delivering energy at the level optimized for diagnostics, with shorter exposure times required.
- The smaller the focal spot, the better the resolution. The NOMAD Pro 2 has a small 0.4mm focal spot.
- Absorption of scatter by the NOMAD Pro 2 backscatter shield reduces incidence of noise for the image receptor, which tends to increase image contrast.

Motion during Exposures

As with the suspended tubehead of a conventional wall-mounted X-ray system, some motion of the tubehead during actual exposures is possible. Use both hands to hold the NOMAD Pro 2 during the exposure and keep steady. The pistol-grip style is ideal for keeping hands behind the backscatter shield, positioning and aiming (with line of sight through the clear shield) so as to achieve a quality image and avoid cone-cutting or retakes.

Image degradation or blurriness does not result due to motion of the handheld X-ray source.²

Time Settings, Sensors, and Complete Exposures

To ensure image quality, use correct time settings. The NOMAD Pro 2 comes with pre-sets to give you a starting point. However, these time settings can be adjusted to achieve the desired image quality and then saved for future use. See [Section 4.10 Settings Menu](#) for further help.

The NOMAD Pro 2 works with the fastest sensor technologies in the market to assure that exposure times are as short as possible, also limiting any effects of motion.

Make sure you are as close to the patient's cheek as possible without touching. If your sensor holder prevents you from getting close enough, check with your dental supplier to find a NOMAD-friendly holder. You can also trim the rod length of your holder, enabling the NOMAD Pro 2 to be placed directly against the positioning ring.

Always double-check for the **Incomplete Exposure** alarm on the NOMAD Pro 2 display. The **Incomplete Exposure** alarm indicates that the trigger was released prematurely, resulting in an incomplete exposure. To achieve complete exposures, do the following: quickly press and release the trigger to enable the X-ray and wait for the device to shift to the **Ready** state; press and hold the trigger until the audible tones and the display indicate the **X-ray Complete** alert.











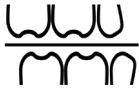

² Third-party studies available upon request. *Journal Of the Michigan Dental Association* – February 2009 – Brooks SL, McMinn WE, Benavides E., University of Michigan, Ann Arbor, MI, USA; *Gammasonics Institute for Medical Research* – April 2006 – Bruce Waters, Senior Radiographer, Westmead Center for Oral Health, Westmead Hospital, NSW Australia; *University of Texas, San Antonio* – Sept. 2006 – Robert P. Langlais, DDS, MS, Director, Graduate OMF Radiology, San Antonio, TX, USA; *Guy's And St. Thomas' Hospital Trust* – January 2009 – Rosemary Eaton, Physicist, Guy's And St. Thomas' Hospital Trust, London England, UK; *Clinical Research Associates (CRA) Foundation* – October, 2006 – Clinical Research Associates (CRA) Foundation, Provo, UT, USA.

4.9 Technique Factors Settings and Adjustments

The factory settings in this chart are intended as a reference starting point only and are based upon average preferences and use with the cone perpendicular to the image receptor. Individual results may vary based upon a number of factors including image density preferences, the various imaging sensors or available film speeds and brands, patient size, practitioner techniques, and preferences.

Pediatric Considerations

Use of equipment and exposure settings designed for an average-sized adult can result in excessive radiation exposure for a smaller patient, especially pediatric. Pediatric patients may be more radio-sensitive than adults (i.e., the cancer risk per unit dose of ionizing radiation is higher), and so unnecessary radiation exposure is of particular concern for pediatric patients.³ Please use caution when configuring the NOMAD Pro 2 by considering the patient's age, size, body habitus, and clinical indication when verifying exposure time settings.

Pre-set Technique Factors Chart 2.5 mA 60 kV						
				Anterior	Posterior	Bitewings
 Digital Sensor	 Adult	0.12	0.16	0.17		
	 Child	0.09	0.13	0.14		
 Film	 Adult	0.30	0.38	0.40		
	 Child	0.18	0.30	0.32		
 Phosphor Plate	 Adult	0.16	0.19	0.20		
	 Child	0.09	0.15	0.16		

³ NAS National Research Council Committee to Assess Health Risks from Exposure to Low Levels of Ionizing Radiation. 2006. Health risks from exposure to low levels of ionizing radiation: BEIR VII phase 2. Washington, D.C.: National Academy of Sciences, National Academies Press.

Technique Factor time settings can be adjusted by the operator. This is done from the main display screen by following these steps:

① Press the **Increase**  or **Decrease**  buttons until the desired time setting is selected.

NOTE: When the **Increase**  or **Decrease**  buttons are pressed and held, the rate at which the displayed time setting changes on screen accelerates.





② Press and release the **Select**  button to activate the **Save Menu**.



③ Select **Yes** by pressing the **Increase**  button.

④ Press the **Select**  button to select **OK**.





⑤ Once saved, this change will be maintained in memory until overwritten or until the factory defaults are restored through the **Reset Defaults** menu item.









4.10 Settings Menu

The NOMAD Pro 2 menus allow the operator to customize settings according to individual preferences. To access the **Main Menu**, press and hold down the **Select**  button for three seconds. When the **Main Menu** appears, the operator can access the desired menu item(s) by pressing the **Increase**  and **Decrease**  buttons to scroll up or down. When the desired menu item is highlighted, press the **Select**  button to access the menu item.

Within the menu items there are options (such as **Yes** and **No**) which are selected using either the **Increase**  or **Decrease**  buttons. Once a selection is made, pressing the **Select**  button confirms the choice.

To exit the **Main Menu**, highlight **Exit** at the bottom of the list and then press the **Select**  button, or power the device off and then on.

Menu Item	Function
System Info	When system information is selected from the settings menu, the device software version information will be displayed on-screen. Pressing the Select  button will return the operator to the settings menu.
Audible Sound	The volume may be adjusted by the operator. The range is from one (softest), up to five (loudest). The Increase  and Decrease  buttons are used to adjust the volume, and the system emits a tone as each volume is selected so the operator can determine the choice. Once the desired volume is determined, pressing the Select  button saves the volume setting.

Menu Item	Function
<p style="text-align: center;">X-ray Counter</p>	<p>The device will display two counters. One is the Overall History Counter, which displays the total lifetime X-ray shots for the device. The other, Trip Counter, can at any time be reset to zero by the operator.</p> <p>When Reset is selected and the Select  button is pressed, the user will be prompted with the message Reset Trip Counter?</p> <p>When Yes is selected and the Select  button is pressed, the Trip Counter is reset to zero and the device is returned to the counter display.</p> <p>When No is selected and the Select  button is pressed, the device is returned to the counter display with no change.</p> <p>When Back is selected and the Select  button is pressed, the device returns to the Main Menu.</p> <p>NOTE: Reset Defaults also resets the Trip Counter to zero.</p>
<p style="text-align: center;">Reset Defaults [Technique Factors and Trip Counter]</p>	<p>Allows the operator to restore the factory default settings with which the device was shipped. These defaults are:</p> <ul style="list-style-type: none"> • X-rays will be unlocked; • Audible sound will be set at full volume; • Trip counter will be reset to zero; • All factory timer settings/technique factor combinations will be reset to factory defaults, overriding any custom settings the operator may have input. <p>The operator can use the Increase  and Decrease  buttons to toggle between Yes and No in response to the menu prompt Reset Exposure Time To Factory Settings?</p> <p>If Yes is selected, the system will confirm the selection by displaying All Custom Settings Will Be Erased. Are You Sure?</p> <p>Selecting Yes and then the Select  button reverts any customized exposure settings to the factory defaults and returns the device to the Main Menu.</p> <p>If ever No is selected and then the Select  button pressed, the customized settings will not be changed and the system returns to the Main Menu.</p>
<p style="text-align: center;">Exit</p>	<p>Allows the user to leave the Main Menu and return to normal operation. (Powering off and then on also exits the menu.)</p>

5.0 Handset Replacement and Care



- Handsets must be charged before initial use! Alternate handsets each week to maximize service life.
- Do not spray disinfectant or cleansers directly on to the handsets!

A **Recharge Handset** alarm on the display panel indicates the need for a recharged handset. The NOMAD Pro 2 cannot emit X-rays with a low, depleted battery (insufficient voltage). Follow these steps to clear the **Recharge Handset** alarm.

- 1 Press and release the **Power**  button on the control panel to turn off the NOMAD Pro 2.
- 2 Place the NOMAD Pro 2 bottom up on a stable surface and depress the release button on the housing, just behind the handset, to release it from the housing.
- 3 Slide the handset forward toward the backscatter shield and the collimator cone.
- 4 Carefully align a newly charged handset and, while avoiding possible pinch points between the housing and the handset, slide it into place. A properly oriented handset should snap into place without force. A clicking sound ensures that the handset is fastened. Make sure the handset is secure by pushing it toward the cone.



IMPORTANT HANDSET CARE NOTES:

- Routinely change discharged handset with fully charged one as needed.
- Battery life is expected to be between 1-2 years or 200-300 charge/discharge cycles, whichever occurs first.
- Battery charge will diminish during extended inactivity. Fully recharge handsets every three months during inactivity. Never place a low charge battery into long-term storage.
- Alternate handsets each week to maximize service life.
- Remove the handsets from the charging cradle once they are fully charged.



- Do not attempt to charge a handset with damaged batteries. Replace battery immediately if there are any signs of deterioration or if batteries do not retain a charge during normal operation.
- Risk of fire or explosion exists if batteries inside the handset are replaced by unauthorized service personnel; do not use batteries from other sources.
- Properly dispose of spent or damaged handsets; return to Aribex or an authorized distributor for replacement and recycling. Do not place in municipal waste stream.

6.0 NOMAD Pro 2 Care and Upkeep



6.1 Alarms and Alerts

The visual and audible **alarms** signal a programmed action designed to prevent harm to operators, patients, and/or the NOMAD Pro 2. The visual/audible **alerts** confirm normal conditions or draw the operator’s attention to a required action.

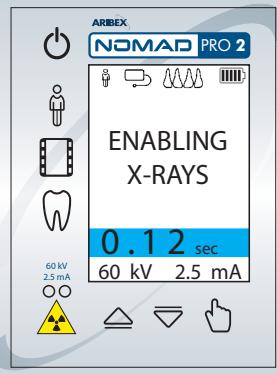
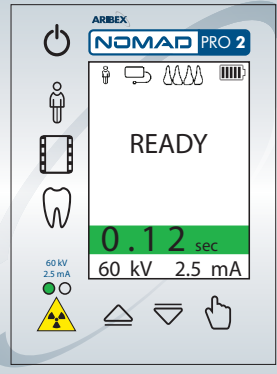
NOTE: All audible signals except X-ray termination and completion may be turned down or off in the **Audible Sounds** menu. See [Section 4.10 Settings Menu](#).

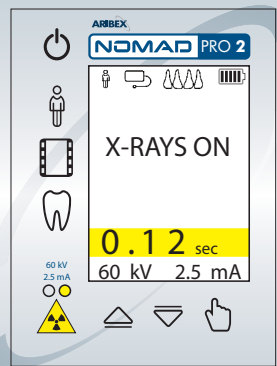
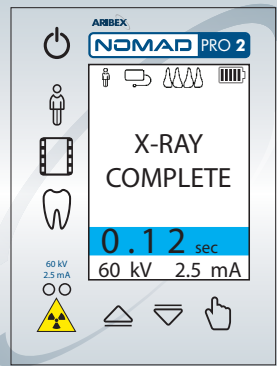
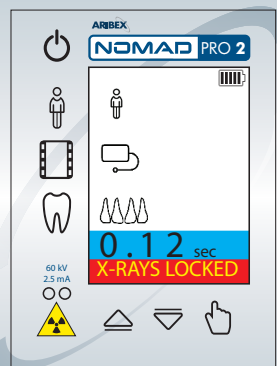
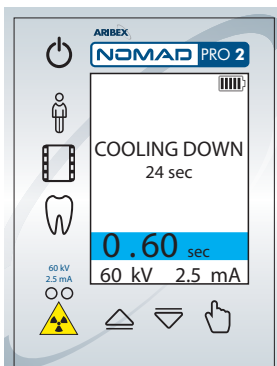
ALERTS & ALARMS: VISUAL AND AUDIBLE INDICATORS		FUNCTION/RESOLUTION
VISUAL	AUDIBLE	
<p>Enabling Alert</p> 	<p>None</p>	<p>This alert is initiated by a single pull and release of the trigger, within one second. If no further action is taken, the device will shift into the Ready state. If the trigger is pulled again before the Ready state is indicated, the second pull is disregarded.</p>
<p>Ready Alert</p> 	<p>Double ascending tone</p>	<p>At the conclusion of the Enabling X-Rays alert, the device will shift into the Ready state. The Ready state will last for 15 seconds, or until one of the buttons on the user interface panel is pressed, or until the exposure is initiated by a second pull of the trigger.</p>

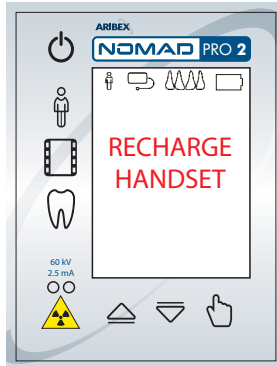
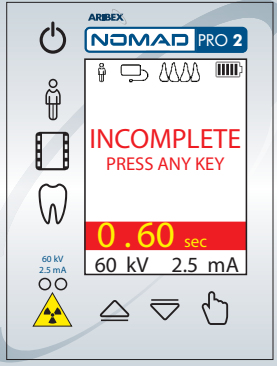
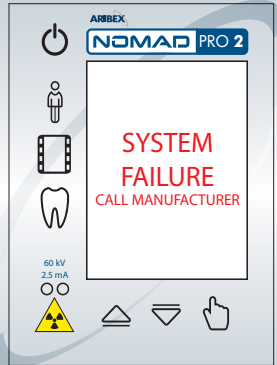
ALERTS & ALARMS: VISUAL AND AUDIBLE INDICATORS		FUNCTION/RESOLUTION
VISUAL	AUDIBLE	
<p>X-ray Exposure Alert</p>  <p>X-ray Complete Alert</p> 	<p>Single tone for duration of exposure (X-ray exposure alert)</p>	<p>At the end of the successful exposure the yellow LED turns off, and the panel briefly displays X-ray Complete alert and the screen returns to the at-rest state.</p>
<p>X-ray Lock Alert</p> 	<p>Tones will be the same as the actual operation tones</p>	<p>When the trigger is activated while the device is in the X-rays locked mode and operation is attempted, various alert messages will be displayed. For example: X-rays Locked, Simulation Only, Simulation Complete. Toggle between Locked and Unlocked by pressing and holding down the Select button and then press the Patient button.</p>
<p>Duty Cycle Exceeded Alarm</p> 	<p>Double tone at the start and end of the cool down cycle</p>	<p>If the operator presses the trigger to activate the Ready alert before the duty cycle time has elapsed, the device will display the warning alert, and a countdown timer will be displayed showing the duty cycle time remaining. This will lock the device and the alert will be displayed until the duty cycle is complete. The device will then return to the at-rest state.</p>

ALERTS & ALARMS: VISUAL AND AUDIBLE INDICATORS		FUNCTION/RESOLUTION
VISUAL	AUDIBLE	
<p>Low Battery Alarm</p> 	<p>5 audible tones</p>	<p>The Recharge Handset alarm terminates after five seconds and goes into auto shutdown. Replace the current handset with a freshly charged handset. NOTE: If the battery voltage is lower than required for the X-ray exposure, the device will not allow the exposure.</p>
<p>Incomplete Exposure Alarm</p> 	<p>A warning tone</p>	<p>This alarm activates if the trigger is released before the timed X-ray exposure finishes. This condition is cleared by pressing any button on the user interface panel, by turning the power off then on. To avoid this error, depress the trigger for the duration of the exposure time.</p>
<p>System Failure Alarm</p> 	<p>Descending tone</p>	<p>See Section 6.2 Troubleshooting (6.2.8) or an Aribex authorized service center.</p>
<p>Handset Failure Alarm</p> 	<p>5 audible tones</p>	<p>See Section 6.2 Troubleshooting (6.2.12) or an Aribex authorized service center.</p>



The NOMAD Pro 2 should not be operated if it has been dropped or if performance degrades; it should be returned to Aribex for an evaluation.

6.2 Troubleshooting

If you encounter results and/or errors in the operation of the NOMAD Pro 2 that are not explained in the previous sections, check the following table on user troubleshooting to determine the need for authorized service. If you have additional questions or require help, contact Aribex: support@aribex.com

Device Symptom	Potential Problem	Corrective Action
6.2.1 Image from X-ray exposure does not have sufficient contrast.	Underexposure (too light).	Increase the exposure time setting; or see "Incomplete Exposure" below.
	Overexposure (too dark).	Decrease the exposure time setting. Also check film expiration date (old film can produce dark, grainy/foggy images).
	Chemical developer (for film-based imaging).	Ensure chemical freshness and proper temperature.
6.2.2 Image from X-ray exposure is blurred.	Combined movements of operator and patient during exposure produced too much distortion.	Check the exposure time setting and re-enable when operator and patient are again properly situated.
6.2.3 Enabling X-rays alert stays on.	Double triggering.	Release the trigger and wait for the Ready alert.
6.2.4 Device does not shift to the Enabling X-rays alert or Ready alert.	The trigger is pulled for longer than one second.	Pull and release the trigger within one second and wait for the Ready alert.
6.2.5 Ready state terminated before an exposure started.	The Ready state expires because the X-ray exposure is not initiated within 15 seconds of the start of the Ready state.	Double-check the exposure time setting and re-enable when operator and patient are again properly situated.
6.2.6 Incomplete Exposure alarm displayed on-screen.	Incomplete exposure: the depressed trigger is released before the timed exposure is able to complete.	This condition automatically clears within 15 seconds or by pressing any button on the user interface panel. Be sure to depress the trigger for the full duration of the timed exposure.

Device Symptom	Potential Problem	Corrective Action
<p>6.2.7 NOMAD Pro 2 automatically shuts down.</p>	<p>NOMAD Pro 2 times out after about three minutes of inactivity.</p>	<p>Manually turn on NOMAD Pro 2 when you are ready to use the device.</p>
	<p>A different problem exists if shut-down occurred during regular activity.</p>	<p>If this condition persists, NOMAD Pro 2 will require authorized service. See Section 7.0 Maintenance and Repair.</p>
<p>6.2.8 System Failure alarm displayed on-screen.</p>	<p>Self-diagnostics, which automatically run during X-ray firing, detects a potential issue.</p>	<p>This warning alarm can be cleared by powering off, then on. If the alarm redisplay, the NOMAD Pro 2 will require authorized service; see Section 7.0 Maintenance and Repair.</p>
<p>6.2.9 There was no power to NOMAD Pro 2 control panel.</p>	<p>If pressing Power several times does not cause the display to illuminate, the attached handset is the likely problem.</p>	<p>Ensure handset is securely attached. Replace with a newly charged handset in order to continue. Use the charging cradle to determine if the first handset battery can be recharged or is spent and must be taken out of service.</p>
	<p>A different problem exists if all handsets appear fully charged.</p>	<p>NOMAD Pro 2 will require authorized service; see Section 7.0 Maintenance and Repair.</p>
<p>6.2.10 When first placing handset on charging cradle, indicator lights illuminate red.</p>	<p>Either handset or charging cradle is damaged.</p>	<p>NOMAD Pro 2 will require authorized service; see Section 7.0 Maintenance and Repair.</p>
<p>6.2.11 The handset did not seem to be working when the trigger was pulled.</p>	<p>The trigger is not communicating with the device.</p>	<p>NOMAD Pro 2 may require authorized service; see Section 7.0 Maintenance and Repair.</p>
<p>6.2.12 Handset Failure alarm displayed on screen.</p>	<p>The handset, in general, is not communicating with the device.</p>	<p>Ensure handset is securely attached.</p>
	<p>The protective fuse in the handset is blown. The batteries are otherwise impaired or at the end of their life cycle.</p>	<p>Replace with a newly charged handset in order to continue. Use the charging cradle to determine the handset status. If the charging bars illuminate solid red or if no illumination occurs, the handset will require authorized service; see Section 7.0 Maintenance and Repair.</p>

7.0 Maintenance and Repair

7.1 Maintenance Schedule





The following quality checks and maintenance items can be performed by any trained personnel. Log sheets for tracking pertinent maintenance information (e.g., what tests were performed by who on what date) can be found in [Section 7.3 Maintenance Log Sheets](#).

On-going Maintenance: Observe the following steps for on-going maintenance of the NOMAD Pro 2.

1. In order to ensure device functionality, schedule the NOMAD Pro 2 for a maintenance inspection at Aribex every five years.
2. Review [Section 1.1 Intended Use/Indications for Use](#) and product labeling periodically in order to verify understanding of indications for use for the NOMAD Pro 2.
3. A routine wipe-down of the NOMAD Pro 2 with a disinfectant cloth or wipe-down between patients is recommended, along with a quarterly visual inspection for damage. Make sure the power is off while cleaning. It is recommended for the handset to be attached during cleaning of the device. Use a **non-acetone** based disinfectant wipe (with less than 17% alcohol content) or a cloth to wipe the exterior surfaces of the NOMAD Pro 2 and charging cradle. Do not use cleaners intended for hard surfaces, since certain chemical combinations may deteriorate the NOMAD Pro 2 plastic prematurely. Also do not use cleaners that leave any sort of residue or sticky build-up on the device surface. Such cleaners can eventually interfere with properly connecting and disconnecting the handset.
4. See also [Section 5.0 Handset Replacement and Care](#) for more information related to battery maintenance.
5. Periodically assess operator familiarity with the NOMAD Pro 2 in order to determine whether refresher training/certification (per local, national, and jurisdictional requirements) is needed.
6. Periodically review [Section 4.9 Technique Factors Settings and Adjustments](#) for comprehension and to assess whether or not chart information is being incorporated into daily use.
7. Periodically review [Section 2.1 Radiation Safety](#) and [Section 2.2 Studies and Data on Leakage and Scatter](#) in order to become reacquainted with safety precautions, which include designating a Significant Zone of Occupancy and understanding exposure information near the unit.

Annual Maintenance: Observe the following steps for annual maintenance of the NOMAD Pro 2.

1. Verify that the **Power** button is working properly. When the device is powered on, the display should illuminate and an indicator alarm should sound.

2. Verify that the device is in lock mode when the **Patient**  and **Select**  buttons are pressed simultaneously. Repeat the process to unlock the device. Verify that the device is unlocked.
3. Verify that, when left on for a period of approximately three minutes without pressing any buttons, the device automatically shuts off.
4. With the device powered on and unlocked, verify that a time selection value displays on the user interface panel. Also check the function of the **Increase**  and **Decrease**  buttons. Pressing the buttons should cause the time setting to adjust accordingly.
5. Verify that the trigger moves freely in and out when depressed and released.
6. Verify that a single pull and release of the trigger enables the X-rays and the device moves into the Ready state.
7. Verify that the backscatter shield is firmly attached to the collimator cone and that it is not cracked or broken.
8. Select an exposure of 1.00 second using the time exposure buttons. Initiate an exposure, but release the exposure switch after a brief period of time before the timer terminates the exposure. Verify that the exposure terminates immediately upon release of the trigger.
9. While taking the exposure, verify that the **X-Rays On** LED illuminates and the audible signal is heard.
10. Ensure that the operator of the system has received a copy of the operator manual.



- The NOMAD Pro 2 should not be operated if it has been dropped, if performance degrades, or if the backscatter shield has been broken or compromised in any way; it should be returned to Aribex for an evaluation.
- For long-term storage, it is recommended to fully recharge batteries every 3 months.



The NOMAD Pro 2, the handsets, and the charging cradle are NOT designed to be user-serviceable. There are dangerous voltages inside. Do not open the device housing; doing so will void the warranty.

7.2 Optional Calibration Checks

The NOMAD Pro 2 is factory calibrated and tested prior to release (see your Certificate of Conformance) and there are no adjustment options. A self-diagnostic is completed each time an exposure is taken. However, the **optional** checks listed below may be performed by a qualified technician as desired. Some locations may require initial and periodic checks as a condition of use.

Set up a calibrated Performance Meter (such as the Victoreen NERO mAx model 8000) according to manufacturer’s specifications to detect and report the following: X-ray Tube Voltage [kV Effective Mode], Radiation Time [ms Effective Mode], and Dose [mR Average Mode]. The filter card for the Test Detector should be in the 50–100kVp position.

Measurement Method: Final performance measurements are made using a NERO mAx model 8000 X-ray meter from Victoreen. Tube current (mA) is sensed across a series connected resistor with an accuracy of $\pm 1\%$ and measured using a digital multimeter, prior to encapsulation; the NOMAD Pro 2 has no provision for external measurement of beam current after final manufacture. Exposure time is measured during the entire exposure, referenced to 75% rise/fall. Accelerating voltage (kV) is measured at both peak (kVp) conditions and effective conditions (kVeff), which is the equivalent kV as if the kV were constant through the whole exposure time. Linearity is calculated per IEC60601-2-7, 50.102.2a.



This X-ray unit may be dangerous to the testing technician and any bystanders unless safe test exposure factors, such as placing the test detector in a lead lined box or using a protective lead apron and thyroid collar, are observed.

Enable the NOMAD Pro 2 and, with the cone perpendicular to the test detector, make exposures into the test detector and capture the resulting data.

Compare the results with the factory release parameters (indicated in the chart below). For results outside these parameters, discontinue use and contact your dealer/distributor or Aribex.

Test Description	Acceptance Limits	Timer Settings and Corresponding Acceptable Ranges				
		20 ms	40 ms	400 ms	600 ms	1000 ms
kVp (eff) Accuracy	60kV $\pm 10\%$	54 to 66	54 to 66	54 to 66	54 to 66	54 to 66
Timer Accuracy	Setpoint $\pm 10\%$, +1ms	17 to 23	35 to 45	359 to 441	539 to 661	899 to 1101



A duty cycle of 1:60 is required after each X-ray discharge to prevent over-heating damage to the X-ray tube.

7.3 Maintenance Log Sheets

Maintenance Test	Year 1	Year 2*	Year 3	Year 4*	Year 5	Year 6
	Date/ Initial	Date/ Initial	Date/ Initial	Date/ Initial	Date/ Initial	
1. Power Button						Schedule Five-Year Maintenance Inspection at Aribex
2. Lock-out Mode						
3. Automatic Shut-Off						
4. Time Selection Buttons						
5. Trigger						
6. Enable/Ready State						
7. Backscatter Shield						
8. Exposure Termination						
9. X-Rays On LED and Audible Signal						
10. Operator Manual						
11. Calibration Checks (Optional)						

Maintenance Test	Year 1	Year 2*	Year 3	Year 4*	Year 5	Year 6
	Date/ Initial	Date/ Initial	Date/ Initial	Date/ Initial	Date/ Initial	
1. Power Button						Schedule Five-Year Maintenance Inspection at Aribex
2. Lock-out Mode						
3. Automatic Shut-Off						
4. Time Selection Buttons						
5. Trigger						
6. Enable/Ready State						
7. Backscatter Shield						
8. Exposure Termination						
9. X-Rays On LED and Audible Signal						
10. Operator Manual						
11. Calibration Checks (Optional)						

*It is recommended to replace handsets after years 2 and 4. Contact Aribex for more information on covering battery replacement through the NOMAD Care Plan.

7.4 Repair

Repairs can only be undertaken by trained service personnel. Direct all questions to Aribex.

The following are user replaceable components:

- Optional Rectangular Collimator Cone Adapter (0.850.0061)
- Handsets (0.850.0087 for standard, 0.850.0088 for black)
- Charging Cradle/AC to DC Power Supply (0.850.0102 for standard, 0.850.0103 for black; other cord sets available upon request)
- Optional Hard-Shell Carrying Case, plastic (0.850.0036)

Damaged or faulty NOMAD Pro 2 materials and components must be properly disposed of according to local requirements, or returned to an authorized distributor or Aribex, Inc. Please protect the environment, and do not improperly dispose of any part of the NOMAD Pro 2 system, the handsets, the charging cradle, or the AC power supply. At end of life, return these items to Aribex for replacement, and proper disposal or recycling.

If product return is required, contact Aribex for a Return Material Authorization (RMA) number and shipping instructions to return the product to an Aribex authorized service center. You will be required to provide the serial number from the label affixed on the underside of the NOMAD Pro 2.

Be sure to include the RMA number on the package you are returning. Products without an RMA number cannot be serviced or given credit consideration.

Aribex will not assume responsibility for shipping damages; however, it will help you file a claim with the freight carrier. Please see warranty information at the end of this manual.



The following are instructions for handling a product at end of life: please, protect the environment and do not improperly dispose of any part of the NOMAD Pro 2 system, handset, or charger; contact an authorized distributor or Aribex, Inc., regarding assistance in returning the product for proper disposal.

8.0 Technical Description

8.1 Basic Technical Specifications

Maximum deviation from fixed factors: $\pm 5\%$ (unless otherwise noted)
 Total weight: 2.5kg

Environmental	
Operation	
Temperature	-5°C to +40°C
Relative humidity	10% to 80%, non-condensing
Storage and transportation	
Temperature	-20°C to +60°C
Relative humidity	95%, non-condensing



Do not use the NOMAD Pro 2 outside of the temperature and relative humidity ranges specified.

Classification / Specification Compliance

IEC 60601-1 (Amnd 1 & 2), 60601-1-3, 60601-2-7; 21 CFR 1020.30 & 1020.31	Internally Powered, Type BF 
MDD (93/42/EEC): Annex IX	Class IIb
IPX specification	IPX0; do not operate under wet conditions
Mode of operation	Intermittent operation
Conductive connection to patient	No conductivity with the applied part

For use in environments where no flammable anesthetics and/or flammable cleaning agents are present; use a **non-acetone** based disinfectant wipe (with less than 17% alcohol content) or a cloth to wipe the exterior surfaces of the NOMAD Pro 2 and charger. Do not use cleaners intended for hard surfaces, since certain chemical combinations may deteriorate the NOMAD Pro 2 plastic prematurely.

Electrical

Rechargeable lithium batteries	22.2V nominal; 25.2V maximum, 1.25A/hr
Low battery alert set point	Any cell (of the 6) <3.5V
Battery current at 2.5mA, 60kVp output	12.5A
Typical energy input	150W

X-ray Controls and Generator

Exposure time range	0.02–1.00 sec. (in 0.01 second increments)
Maximum duty cycle	1:60 (one 1 second exposure every 60 seconds)
Minimum permanent filtration	$\geq 1.5\text{mm Al}$ (0.8mm glass, 0.5mm Al, 0.2mm plastic cap)

X-ray Controls and Generator

Output power	150W nominal at 60kV, 2.5mA
Generator rating	2.5mA ($\pm 5\%$) at 60kVp ($\pm 10\%$)
Leakage technique factors	60kV, 2.5mA, 1.00 sec.
Maximum air kerma at handgrips and control panel	<0.02mGy in 1 hour

Measurement Base of Technique Factors

The kV is measured during pre-pot testing using a calibrated high voltage divider with a guaranteed accuracy of $\pm 2\%$. Final performance measurements are made using a NERO mAx model 8000 X-ray meter from Victoreen. Tube current (mA) is sensed across a series connected resistor with an accuracy of $\pm 1\%$ and measured using a digital multimeter, prior to encapsulation; the NOMAD Pro 2 has no provision for external measurement of beam current after final manufacture. Exposure time is measured during the entire exposure, references to 75% rise/fall, using the NERO mAx model 8000 X-ray meter.

Collimator Cone

Minimum source to skin distance	20cm (from focal spot to cone tip)
Nominal dose output at cone tip (20cm)	3.41 mGy/sec.
X-ray field size and configuration	6cm diameter circle

8.2 X-ray Tube Specifications and Characteristics

The KL 11-0.4-70 is designed for intra-oral dental imaging by an X-ray unit and is available for nominal tube voltage with self-rectified or constant potential circuit – manufactured by Kailong.

Nominal tube voltage	50 – 70kV
Nominal focal spot (IEC 60336:1993)	0.4mm
Maximum anode heat content	4500J
Maximum current continuous service	1.5mA x 70kV
Maximum anode cooling rate	100W
Nominal anode input power	430W
Target material	Tungsten
Minimum target angle	12°
Filament characteristics	2.2 – 3.0A, 2.0 – 3.5V
Minimum permanent filtration (IEC 60522:1999)	0.8mm Al/50kV
X-ray source assembly maximum heat content	6500J
X-ray source assembly	PS454

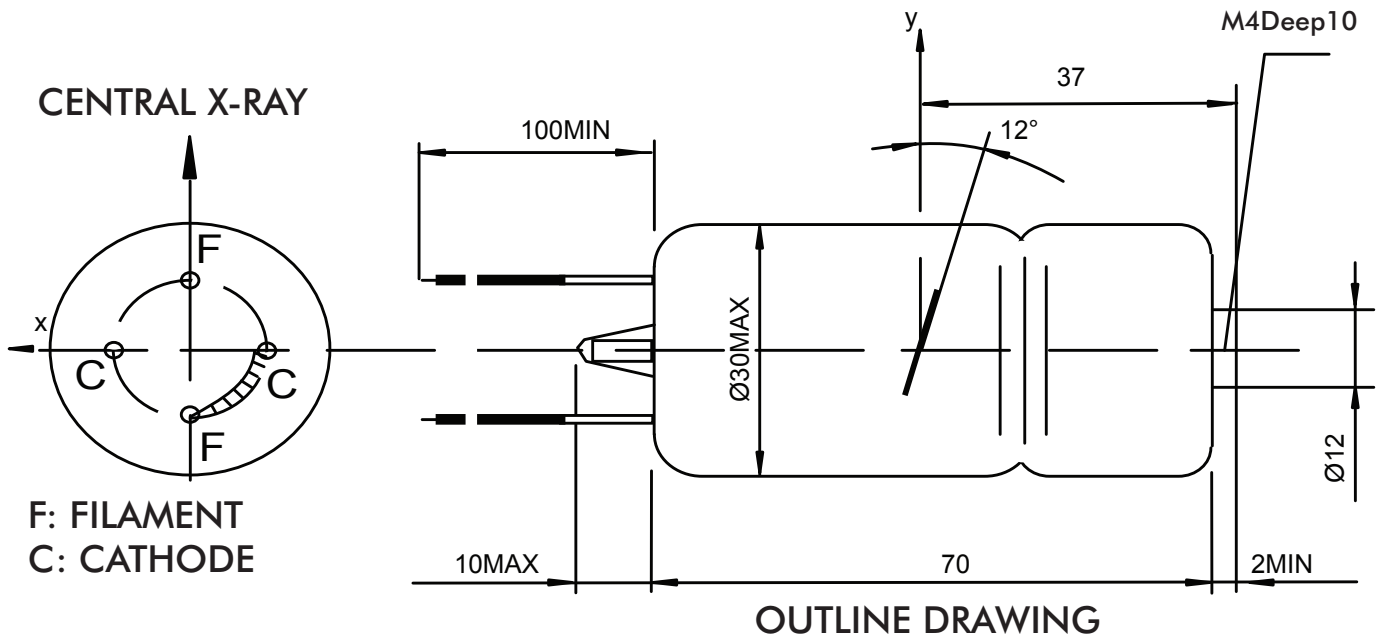

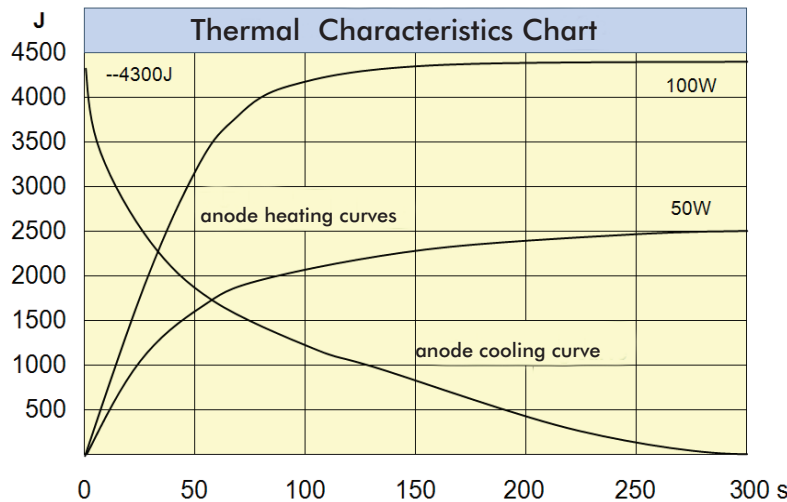
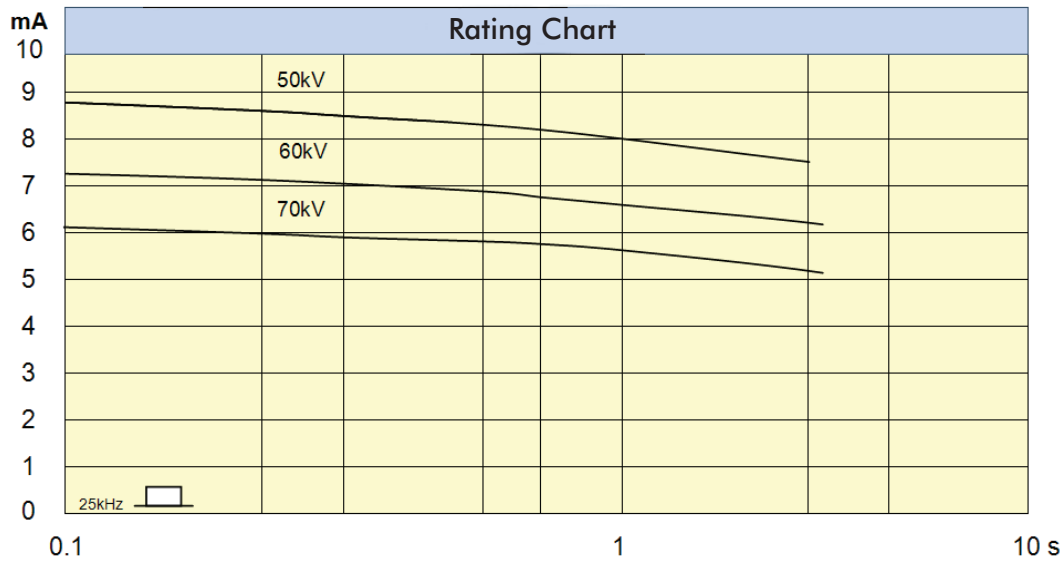
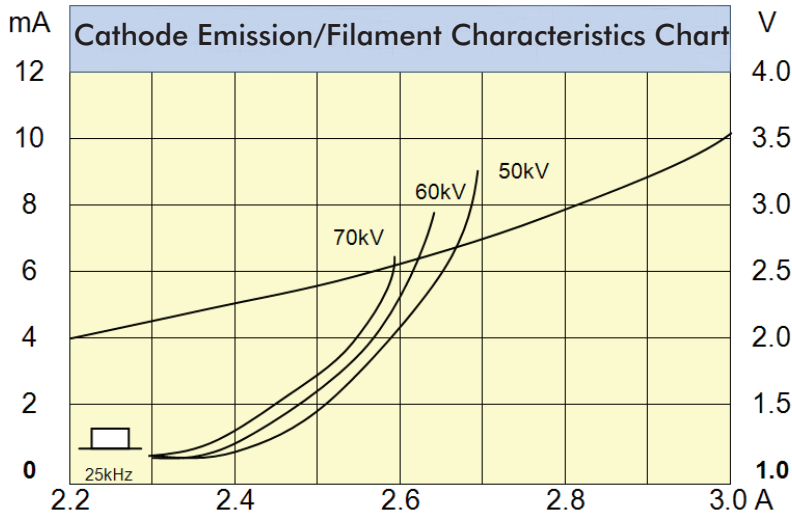

NOTE: The X-ray source assembly heating and cooling curves are equivalent to the anode heating curves shown here.

Maximum continuous heat dissipation will be made available upon request from Aribex.

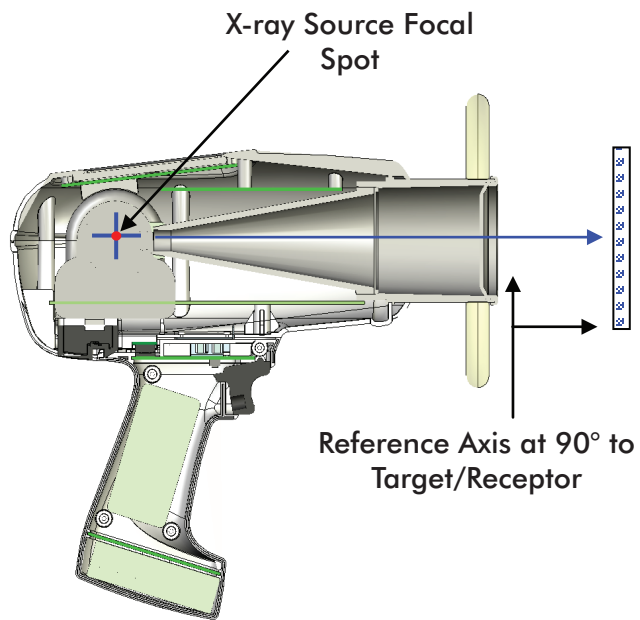
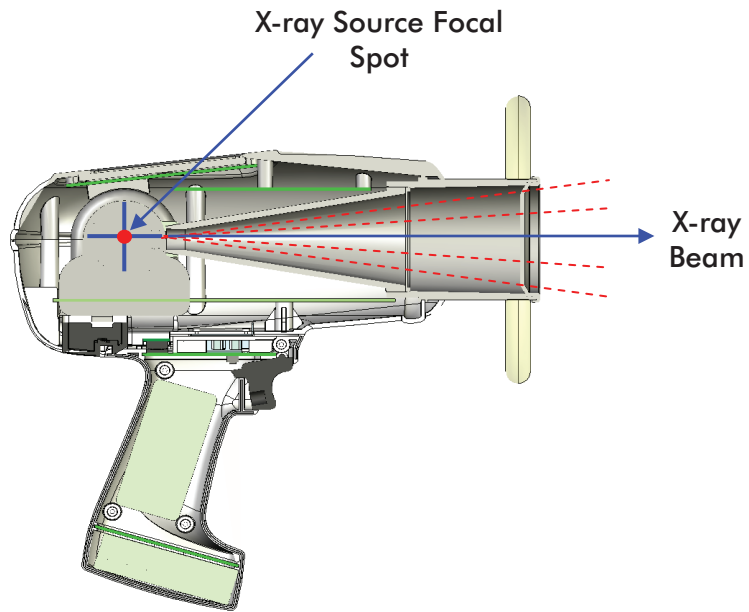

8.3 EMC Data

Independent laboratory testing for electromagnetic compatibility for conformity to the Sub-clause 5.10 requirements of ISO/IEC 17025 “General Criteria for the Competence of Testing and Calibration Laboratories” was conducted by:

Nemko CCL, Inc.
 1940 West Alexander St.
 Salt Lake City, Utah 84119-2039
 USA

The NOMAD Pro 2 Dental X-ray System has been tested and found to comply with the limits of electromagnetic compatibility standards for medical devices, which provide reasonable protection against harmful interference in a typical medical/dental setting. The NOMAD Pro 2 may generate and radiate radio frequency energy that causes interference to other devices in the vicinity, if not used in accordance with the instructions (though there is no guarantee that interference will not occur in a particular instance). If interference occurs, the user is encouraged to try the following corrective measures: reorient or relocate the receiving device; increase the separation between the equipment; consult the device manufacturer or field service technician for help.

The NOMAD Pro 2 is intended for use in the electromagnetic environment as specified. The following tables describe the tests performed and the status of the testing. The NOMAD Pro 2 uses RF energy only for its internal function. Its RF emissions are very low and are not likely to cause any interference in nearby electronic equipment.

The test results show that the NOMAD Pro 2 is suitable for use in all establishments, including domestic establishments and those directly connected to public low-voltage power supply networks that supply buildings used for domestic purposes.

Test Specifications – Radio Frequency Emissions and Electromagnetic Immunity tests in accordance with requirements of EN 60601-1-2, A1: 2006 as follows:

Test Type	In Accordance with Document	Document Title
Conducted and Radiated Emissions	EN 55011:2007, Class “B”	Industrial, Scientific and Medical (ISM) Radiofrequency Equipment – Radio Disturbance Characteristics – Limits and Methods of Measurement
Electrostatic Discharge Immunity	IEC 61000-4-2:1995, A1:1998, A2:2000	Electromagnetic Compatibility, Basic Immunity Standard, Electrostatic Discharge Immunity Test
Radio Frequency Immunity	IEC 61000-4-3:2006	Electromagnetic Compatibility, Basic Immunity Standard, Radiated Radio Frequency Electromagnetic Field, Immunity Test

Test Type	In Accordance with Document	Document Title
Power Frequency Magnetic Field Immunity	IEC 61000-4-8:1993, A1:2000	Electromagnetic Compatibility, Testing and Measurement Techniques for Power Frequency Magnetic Field, Immunity Test

NOTE: The tests documented in the table above are the only tests required for this product as it is a battery operated device and the AC Adapter (CP-0062) is certified. IEC 61000-3-2, 3-3, 4-4, 4-5, 4-6, 4-11, and EN 55014 1:2006 are not applicable.

Emissions Test Summary

Specification	Frequency Range	Compliance Status
EN 55011:2007, Group 1, Class "B" Conducted Emissions	0.15MHz – 30.00MHz	PASS
EN 55011:2007, Group 1, Class "B" Radiated Emissions	30.0MHz – 2500MHz	PASS

Immunity Test Summary

Specification	Minimum Test Level Required per EN 60601-1-2	Test Level Completed	Compliance Status
IEC 61000-4-2:1995, A1:1998, A2:2000 – Electrostatic Discharge Immunity	Air discharge up to ± 8 kV; contact discharge up to ± 6 kV	Air discharge up to ± 8 kV; contact discharge up to ± 6 kV	PASS
IEC 61000-4-3:2006 – RF Radiated Fields Immunity	Radiation field strength of 3V/m from 80 – 6000MHz (80% AM @ 1kHz)	Radiation field strength of 3V/m from 80 – 6000MHz (80% AM @ 1kHz)	PASS
IEC 61000-4-8:1993, A1:2000 – Power Frequency Magnetic Field Immunity	Helmholtz coil at 50Hz and 60Hz, to 3 amps (rms) per	Helmholtz coil at 50Hz and 60Hz, to 3 amps (rms) per meter	PASS

8.4 Limited Warranty

LIMITED WARRANTY

COVERAGE. Aribex, Inc. warrants its medical and dental X-ray equipment to be free from any defects in material or workmanship for a period of one (1) year from the date of purchase. Aribex, Inc. also warrants any accessories purchased from Aribex to be free from any defects in material or workmanship for the period of one (1) year from the date of purchase.

The liability of Aribex, Inc. is limited to repair or replacement of any parts that Aribex or its authorized resellers determine to be defective. Contact Aribex for a Return Material Authorization (RMA) number and shipping instructions. Parts proving defective shall be repaired or replaced free of charge (labor and shipping included), if defective equipment is returned (shipment return service) to Aribex (USA) or the location of the authorized service center. Equipment repaired or replaced under warranty shall continue to be warranted for the balance of the original warranty term. All warranty claims must be made not later than ten (10) business days following the expiration of the applicable warranty period.

LIMITATIONS OF COVERAGE. This warranty does not apply to equipment that is or has been abused, misused, or altered (including opening enclosure or tampering), improperly maintained, subjected to use beyond rated conditions, or damaged as a result of any carelessness or accidents. This warranty does not cover ordinary wear and tear or maintenance.

LIMITATIONS OF LIABILITY. Aribex, Inc. makes no other warranty, either expressed or implied, with respect to any equipment purchased from Aribex, including without limitation any implied warranties of merchantability or fitness for a particular purpose, whether or not Aribex may have been informed of the actual uses to which any of such equipment may be put. Aribex, Inc. shall not under any circumstance be liable for incidental, indirect, consequential, punitive or exemplary damages, including without limitation damages for delay or lost profits, and in no event shall liability of Aribex arising from the purchase, sale or use of the equipment, or breach of any warranty made above, exceed in the aggregate the purchase price paid therefore.



0473

ISO 13485 / ISO 9001
CERTIFIED COMPANY

**© Aribex, Inc. 2005, 2014
All Rights Reserved**

English is the original draft language for this manual.

Aribex
11727 Fruehauf Dr
Charlotte, NC 28273
U.S.A.



Phone: +1-801-226-5522
Fax: +1-801-434-7233
Email: support@aribex.com
<http://www.aribex.com>

EC

REP

MT Promedt Consulting, Altenhofstr. 80, 66386 St. Ingbert, Germany

0.850.0507 Rev AB 2/27/2015