

Applied Biosystems 3730/3730x/

DNA Analyzers

User Guide

© Copyright 2007, 2010 Applied Biosystems. All rights reserved.

Information in this document is subject to change without notice. Applied Biosystems assumes no responsibility for any errors that may appear in this document. This document is believed to be complete and accurate at the time of publication. In no event shall Applied Biosystems be liable for incidental, special, multiple, or consequential damages in connection with or arising from the use of this document.

NOTICE TO PURCHASER:

This instrument, Serial No. _____, is Authorized for use in DNA sequencing and fragment analysis. This authorization is included in the purchase price of this instrument and corresponds to the up-front fee component of a license under process claims of U.S. patent claims and under all process claims for DNA sequence and fragment analysis of U.S. patents now or hereafter owned or licensable by Applied Biosystems for which an Authorization is required, and under corresponding process claims in foreign counterparts of the foregoing for which an Authorization is required. The running royalty component of licenses may be purchased from Applied Biosystems or obtained by using Authorized reagents purchased from Authorized suppliers in accordance with the label rights accompanying such reagents. Purchase of this instrument does not itself convey to the purchaser a complete license or right to perform the above processes. This instrument is also licensed under U.S. patent claims and apparatus and system claims in foreign counterparts thereof. No rights are granted expressly, by implication or by estoppel under composition claims or under other process or system claims owned or licensable by Applied Biosystems. For more information regarding licenses, please contact the Director of Licensing at Applied Biosystems, 850 Lincoln Centre Drive, Foster City, California 94404, USA.

Covered by one or more of U.S. Pats. Nos. RE37,606; RE37,941.

NOTICE TO PURCHASER:

The purchase price of the Applied Biosystems 3730/3730xl DNA Analyzers includes a grant of a limited, non-transferable license under U.S. patent claims and method claims of its foreign counterparts, and element claims of its foreign counterparts, to use this particular instrument for electrophoresis methods employing fluorescence as a means of detection. No other licenses or rights are hereby conveyed either expressly, by implication, or estoppel including, but not limited to, any claims to a composition.

TRADEMARKS:

The Applied Biosystems 3730 and 3730xl DNA Analyzer includes patented technology licensed from Hitachi, Ltd. as part of a strategic partnership between Applied Biosystems and Hitachi, Ltd., as well as patented technology of Applied Biosystems.

ABI PRISM, Applied Biosystems, BigDye, and MicroAmp are registered trademarks of Applied Biosystems or its subsidiaries in the U.S. and certain other countries.

ABI, GeneMapper, GeneScan, Hi-Di, POP, and POP-7, are trademarks of Applied Biosystems or its subsidiaries in the U.S. and certain other countries.

Microsoft, Windows, and Windows NT are registered trademarks of the Microsoft Corporation in the United States and/or other countries.

Oracle is a registered trademark of the Oracle Corporation.

pGEM is a registered trademark of Promega Corporation.

All other trademarks are the sole property of their respective owners.

Contents

Preface

About This Guide	vii
Conventions Used in This Guide	viii
Obtaining Technical Support	viii
General Safety	ix
Chemical Safety	ix
Instrument Safety	xi

Safety and EMC Compliance Information

Safety Conventions Used in This Document	xiv
Sources of Safety Information	xiv
Symbols on Instruments	xv
Safety Labels on Instruments	xvi
General Instrument Safety	xvii
Chemical Safety	xviii
Chemical Waste Safety	xix
Electrical Safety	xx
Physical Hazard Safety	xxi
Biological Hazard Safety	xxii
Laser Safety	xxii
Bar Code Scanner Laser Safety	xxiii
Computer Workstation Safety	xxiii
Safety and Electromagnetic Compatibility (EMC) Standards	xxiv

Chapter 1 Performing a Run

Instrument Parts	1-2
A Typical Run	1-3
Working with Samples and Plate Assemblies	1-5
Starting the Applied Biosystems 3730/3730xl System	1-9
Preparing the Instrument	1-14
Calibrating the Instrument	1-23
Placing a Plate in the Stacker	1-24
Running the Instrument	1-26
Default Load Maps	1-28

Monitoring a Run	1-43
Working with Data in The Run History View	1-51
Viewing Analyzed Data	1-60

Chapter 2 3730/3730xl Data Collection Software and DNA Sequencing

3730/3730xl Data Collection Software and Sequencing Analysis Software v5.0	2-2
About Plate Records and Sequencing	2-4
Using the Plate Manager for Sequencing	2-5
Working With a Results Group	2-12
Creating an Instrument Protocol For Sequencing	2-23
Working with Analysis Protocols for Sequencing	2-28
Plate Search	2-37

Chapter 3 3730/3730xl Data Collection and Fragment Analysis

3730/3730xl Data Collection Software and GeneMapper™ Software v3.0	3-2
Sample Preparation	3-5
About Plate Records	3-6
Using the Plate Manager For GeneMapper Software	3-8
Working With a Results Group	3-13
Working With Instrument Protocols For Fragment Analysis	3-25
Using the AutoAnalysis Manager	3-29
Plate Search	3-35
Autoanalysis Integration	3-39

Chapter 4 Spatial and Spectral Calibrations

Spatial Calibration	4-2
Spectral Calibration	4-9

Chapter 5 Maintenance

Instrument Maintenance	5-2
Routine Cleaning	5-3
Fluids and Waste	5-9
Capillary Array	5-12
Syringes	5-18
Polymer Blocks	5-21
Checking Available Space on Drives D, E, and F	5-30
Hard Disk Status	5-31
Deleting Records from the Database	5-32

Appendix A Warranty and Service Information

Computer Configuration	A-2
Limited Product Warranty	A-2
Damages, Claims, Returns	A-4

Appendix B Error Messages

Error Messages	B-2
----------------------	-----

Index



Preface

About This Guide

Audience This manual is written for principle investigators and laboratory staff who are planning to operate and maintain the Applied Biosystems 3730/3730xl DNA Analyzers.

Assumptions The following background is assumed:

- Familiarity with Microsoft® Windows® 2000 operating system.
- Knowledge of general techniques for handling DNA samples and preparing them for electrophoresis.
- A general understanding of hard drives and data storage, file transfers, and copying and pasting.

If you want to integrate the 3730/3730xl DNA Analyzers into your existing laboratory data flow system, you need networking experience.

Send Us Your Comments Applied Biosystems welcomes your comments and suggestions for improving its manuals. You can e-mail your comments to:

Document_Feedback@appliedbiosystems.com

Conventions Used in This Guide

This guide uses the following conventions to make text easier to understand. For example:

- **Bold** indicates user action. For example:
Type **0** and press **Enter** for the remaining fields.
- *Italic* text denotes new or important words and is also used for emphasis. For example:
Before analyzing, ensure that you have enough fresh matrix.

Obtaining Technical Support

Applied Biosystems Web Site

A services and support page is available on the Applied Biosystems Web site. To access this, go to: <http://www.appliedbiosystems.com> and click the link for services and support.

At the services and support page, you can:

- Search through frequently asked questions (FAQs)
- Submit a question directly to Technical Support
- Order Applied Biosystems user documents, MSDSs, certificates of analysis, and other related documents
- Download PDF documents
- Obtain information about customer training
- Download software updates and patches

In addition, the services and support page provides worldwide telephone and fax numbers to contact Applied Biosystems Technical Support and Sales facilities.

Important Phone Numbers

For Technical Support dial 1.800.831.6844 and then press 5. Enter your model number (310, 3100, 3700, 394, 3900, 7000, 7700, 7900, or 3730/3730xl).

If you do not know your model number, press the * (asterisk) key and use the following as your guide:

Fluorescent Sequencing 1.800.831.6844

Press 5, then 1, then 4

Fax: 1.650.638.5891

5:30 A.M. to 5:00 P.M. Pacific time.

Fragment Analysis Chemistry including SNPshot & labeled primers 1.800.831.6844

Press 5, then 1, then 3

Fax: 1.650.638.5891

5:30 A.M. to 5:00 P.M. Pacific time.

General Safety

Documentation User Attention Words

Five user attention words appear in the text of all Applied Biosystems user documentation. Each word implies a particular level of observation or action as described below.

Note: Calls attention to useful information.

IMPORTANT! Indicates information that is necessary for proper instrument operation, accurate chemistry kit use, or safe use of a chemical.



CAUTION

Indicates a potentially hazardous situation which, if not avoided, may result in minor or moderate injury. It may also be used to alert against unsafe practices.



WARNING

Indicates a potentially hazardous situation which, if not avoided, could result in death or serious injury.



DANGER

Indicates an imminently hazardous situation which, if not avoided, will result in death or serious injury. This signal word is to be limited to the most extreme situations.

Site Preparation and Safety Guide

A site preparation and safety guide is a separate document sent to all customers who have purchased an Applied Biosystems instrument. Refer to the guide written for your instrument for information on site preparation, instrument safety, chemical safety, and waste profiles.

Chemical Safety

Chemical Hazard Warning



WARNING

CHEMICAL HAZARD. Some of the chemicals used with Applied Biosystems instruments and protocols are potentially hazardous and can cause injury, illness, or death.

- Read and understand the material safety data sheets (MSDSs) provided by the chemical manufacturer before you store, handle, or work with any chemicals or hazardous materials.
- Minimize contact with chemicals. Wear appropriate personal protective equipment when handling chemicals (*e.g.*, safety glasses, gloves, or protective clothing). For additional safety guidelines, consult the MSDS.
- Minimize the inhalation of chemicals. Do not leave chemical containers open. Use only with adequate ventilation (*e.g.*, fume hood). For additional safety guidelines, consult the MSDS.
- Check regularly for chemical leaks or spills. If a leak or spill occurs, follow the manufacturer's cleanup procedures as recommended on the MSDS.
- Comply with all local, state/provincial, or national laws and regulations related to chemical storage, handling, and disposal.

Chemical Waste Hazard Warning



WARNING

CHEMICAL WASTE HAZARD. Wastes produced by Applied Biosystems instruments are potentially hazardous and can cause injury, illness, or death.

- Read and understand the material safety data sheets (MSDSs) provided by the manufacturers of the chemicals in the waste container before you store, handle, or dispose of chemical waste.
- Handle chemical wastes in a fume hood.
- Minimize contact with chemicals. Wear appropriate personal protective equipment when handling chemicals (*e.g.*, safety glasses, gloves, or protective clothing). For additional safety guidelines, consult the MSDS.
- Minimize the inhalation of chemicals. Do not leave chemical containers open. Use only with adequate ventilation (*e.g.*, fume hood). For additional safety guidelines, consult the MSDS.
- After emptying the waste container, seal it with the cap provided.
- Dispose of the contents of the waste tray and waste bottle in accordance with good laboratory practices and local, state/provincial, or national environmental and health regulations.

About MSDSs

Some of the chemicals used with this instrument may be listed as hazardous by their manufacturer. When hazards exist, warnings are prominently displayed on the labels of all chemicals.

Chemical manufacturers supply a current MSDS before or with shipments of hazardous chemicals to new customers and with the first shipment of a hazardous chemical after an MSDS update. MSDSs provide you with the safety information you need to store, handle, transport and dispose of the chemicals safely.

We strongly recommend that you replace the appropriate MSDS in your files each time you receive a new MSDS packaged with a hazardous chemical.



WARNING CHEMICAL HAZARD. Be sure to familiarize yourself with the MSDSs before using reagents or solvents.

Ordering MSDSs

You can order free additional copies of MSDSs for chemicals manufactured or distributed by Applied Biosystems using the contact information below.

To order documents by automated telephone service:

1. From the U.S. or Canada, dial **1.800.487.6809**.
2. Follow the voice instructions to order documents (for delivery by fax).

Note: There is a limit of five documents per fax request.

To order documents by telephone:

In the U.S.	Dial 1.800.345.5224 , and press 1 .
In Canada	Dial 1.800.668.6913 , and press 1 for English or 2 for French.

To obtain documents through the Applied Biosystems Web site:

1. Go to **<http://docs.appliedbiosystems.com/msdssearch.html>**
2. In the **SEARCH** field, type in the chemical name, part number, or other information that will appear in the MSDS and click **SEARCH**.

Note: You may also select the language of your choice from the drop-down list.

- When the **Search Results** page opens, find the document you want and click on it to open a PDF of the document.

For chemicals not manufactured or distributed by Applied Biosystems, call the chemical manufacturer.

About Waste Profiles

A waste profile was provided with this instrument and is contained in the *Applied Biosystems 3730/3730xl DNA Analyzers Site Preparation and Safety Guide*. Waste profiles list the percentage compositions of the reagents within the waste stream at installation and the waste stream during a typical user application, although this application may not be used in your laboratory. These profiles assist users in planning for instrument waste handling and disposal. Read the waste profiles and all applicable MSDSs before handling or disposing of waste.

IMPORTANT! Waste profiles are not a substitute for MSDS information.

About Waste Disposal

As the generator of potentially hazardous waste, it is your responsibility to perform the actions listed below.

- Characterize (by analysis if necessary) the waste generated by the particular applications, reagents, and substrates used in your laboratory.
- Ensure the health and safety of all personnel in your laboratory.
- Ensure that the instrument waste is stored, transferred, transported, and disposed of according to all local, state/provincial, or national regulations.

Note: Radioactive or biohazardous materials may require special handling, and disposal limitations may apply.

Instrument Safety

Instrument Safety Labels

Safety labels are located on the instrument. Each safety label has three parts:

- A signal word panel, which implies a particular level of observation or action (e.g., CAUTION or WARNING). If a safety label encompasses multiple hazards, the signal word corresponding to the greatest hazard is used.
- A message panel, which explains the hazard and any user action required.
- A safety alert symbol, which indicates a potential personal safety hazard. See the *Applied Biosystems 3730/3730xl DNA Analyzers Site Preparation and Safety Guide* for an explanation of all the safety alert symbols provided in several languages.

Before Operating the Instrument

Ensure that everyone involved with the operation of the instrument has:

- Received instruction in general safety practices for laboratories
- Received instruction in specific safety practices for the instrument
- Read and understood all related MSDSs



CAUTION

Avoid using this instrument in a manner not specified by Applied Biosystems. Although the instrument has been designed to protect the user, this protection can be impaired if the instrument is used improperly.

Computer Workstation Safety

Correct ergonomic configuration of your computer workstation can prevent stress-producing effects such as fatigue, pain, and strain. Minimize or eliminate these effects on your body by designing your workstation to promote neutral or relaxed working positions.



CAUTION MUSCULOSKELETAL AND REPETITIVE MOTION

HAZARD. These hazards are caused by potential risk factors that include, but are not limited to, repetitive motion, awkward posture, forceful exertion, holding static unhealthy positions, contact pressure, and other workstation environmental factors.

- Use equipment that comfortably supports the user in neutral working positions and maintains adequate accessibility to the keyboard, monitor, and mouse.
- Position keyboard, mouse, and monitor to promote relaxed body and head postures.

Safety and EMC Compliance Information

This section includes the following topics:

Safety Conventions Used in This Document.	x
Sources of Safety Information.	x
Symbols on Instruments	xi
Safety Labels on Instruments	xii
General Instrument Safety.	xiii
Chemical Safety	xiv
Chemical Waste Safety	xv
Electrical Safety	xvii
Physical Hazard Safety	xviii
Biological Hazard Safety.	xix
Laser Safety.	xix
Bar Code Scanner Laser Safety.	xx
Computer Workstation Safety	xxi
Safety and Electromagnetic Compatibility (EMC) Standards	xxii

Safety Conventions Used in This Document

Safety Alert Words Four safety alert words appear in Applied Biosystems user documentation. Each word implies a particular level of observation or action, as described below:

IMPORTANT! Indicates information that is necessary for proper instrument operation, accurate chemistry kit use, or safe use of a chemical.

 **CAUTION** Indicates a potentially hazardous situation that, if not avoided, may result in minor or moderate injury. It may also be used to alert against unsafe practices, damage to an instrument, or loss of data.

 **WARNING** Indicates a potentially hazardous situation that, if not avoided, could result in death or serious injury.

 **DANGER** Indicates an imminently hazardous situation that, if not avoided, will result in death or serious injury.

Examples Examples of the safety alert words appear below:

IMPORTANT! You must create a separate Sample Entry Spreadsheet for each 96-well microtiter plate.

 **CAUTION** Do not touch the lamp. This can damage the lamp.

 **WARNING** **CHEMICAL HAZARD. Formamide** is harmful if absorbed through the skin and may cause irritation to the eyes, skin, and respiratory tract. It may cause damage to the central nervous system and the male and female reproductive systems, and is a possible birth-defect hazard. Read the MSDS and follow the handling instructions. Wear appropriate protective eyewear, clothing, and gloves.

 **DANGER** **ELECTRICAL HAZARD.** Failure to ground the instrument properly can lead to an electrical shock. Ground the instrument according to the provided instructions.







Sources of Safety Information

For System Operators Operational safety information for the is provided in the following documents, which are included with each system.



Material Safety Data Sheets (MSDSs) MSDSs provide information you need to store, handle, transport, and dispose of chemicals safely. Refer to “About MSDSs” on page xviii.



Symbols on Instruments

Electrical Symbols The following table describes the electrical symbols that may be displayed on Applied Biosystems instruments.

Symbol	Description
	Indicates the On position of the main power switch.
	Indicates the Off position of the main power switch.
	Indicates the On/Off position of a push-push main power switch.
	Indicates a terminal that may be connected to the signal ground reference of another instrument. This is not a protected ground terminal.
	Indicates a protective grounding terminal that must be connected to earth ground before any other electrical connections are made to the instrument.
	Indicates a terminal that can receive or supply alternating current or voltage.
	Indicates a terminal that can receive or supply alternating or direct current or voltage.

Safety Symbols The following table describes the safety symbols that may be displayed on Applied Biosystems instruments. Each symbol may appear by itself or in combination with text that explains the relevant hazard (see “Safety Labels on Instruments” on page xvi). These safety symbols may also appear next to DANGERS, WARNINGS, and CAUTIONS that occur in the text of this and other product-support documents.

Symbol	Description
	Indicates that you should consult the manual for further information and to proceed with appropriate caution.
	Indicates the presence of an electrical shock hazard and to proceed with appropriate caution.
	Indicates the presence of a hot surface or other high-temperature hazard and to proceed with appropriate caution.

	Indicates the presence of a laser inside the instrument and to proceed with appropriate caution.
	Indicates the presence of moving parts and to proceed with appropriate caution.

Safety Labels on Instruments

The following CAUTION, WARNING, and DANGER statements may be displayed on Applied Biosystems instruments in combination with the safety symbols described in the preceding section.

English	Francais
CAUTION Hazardous chemicals. Read the Material Safety Data Sheets (MSDSs) before handling.	ATTENTION Produits chimiques dangereux. Lire les fiches techniques de sûreté de matériels avant la manipulation des produits.
CAUTION Hazardous waste. Read the waste profile (if any) in the site preparation guide for this instrument before handling or disposal.	ATTENTION Déchets dangereux. Lire les renseignements sur les déchets avant de les manipuler ou de les éliminer.
WARNING Hot lamp.	AVERTISSEMENT Lampe brûlante.
WARNING Hot. Replace lamp with an Applied Biosystems lamp.	AVERTISSEMENT Composants brûlants. Remplacer la lampe par une lampe Applied Biosystems.
CAUTION Hot surface.	ATTENTION Surface brûlante.
DANGER High voltage.	DANGER Haute tension.
WARNING To reduce the chance of electrical shock, do not remove covers that require tool access. No user-serviceable parts are inside. Refer servicing to Applied Biosystems qualified service personnel.	AVERTISSEMENT Pour éviter les risques d'électrocution, ne pas retirer les capots dont l'ouverture nécessite l'utilisation d'outils. L'instrument ne contient aucune pièce réparable par l'utilisateur. Toute intervention doit être effectuée par le personnel de service qualifié de Applied Biosystems.
DANGER Laser radiation present when open and interlock defeated. Avoid direct exposure to laser beam.	DANGER Rayonnement laser en cas d'ouverture et d'une neutralisation des dispositifs de sécurité. Eviter toute exposition directe avec le faisceau.
DANGER Laser radiation when open. Avoid direct exposure to laser beam.	DANGER Rayonnement laser en cas d'ouverture. Eviter toute exposition directe avec le faisceau.
CAUTION Moving parts.	ATTENTION Parties mobiles.

General Instrument Safety



WARNING PHYSICAL INJURY HAZARD. Use this product only as specified in this document. Using this instrument in a manner not specified by Applied Biosystems may result in personal injury or damage to the instrument.

Moving and Lifting the Instrument



CAUTION PHYSICAL INJURY HAZARD. The instrument is to be moved and positioned only by the personnel or vendor specified in the applicable site preparation guide. If you decide to lift or move the instrument after it has been installed, do not attempt to lift or move the instrument without the assistance of others, the use of appropriate moving equipment, and proper lifting techniques. Improper lifting can cause painful and permanent back injury. Depending on the weight, moving or lifting an instrument may require two or more persons.

Moving and Lifting Stand-Alone Computers and Monitors



WARNING Do not attempt to lift or move the computer or the monitor without the assistance of others. Depending on the weight of the computer and/or the monitor, moving them may require two or more people.

Things to consider before lifting the computer and/or the monitor:

- Make sure that you have a secure, comfortable grip on the computer or the monitor when lifting.
- Make sure that the path from where the object is to where it is being moved is clear of obstructions.
- Do not lift an object and twist your torso at the same time.
- Keep your spine in a good neutral position while lifting with your legs.
- Participants should coordinate lift and move intentions with each other before actually lifting and carrying.
- Instead of lifting the object from the packing box, carefully tilt the box on its side and hold it stationary while someone slides the contents out of the box.

Operating the Instrument

Ensure that anyone who operates the instrument has:

- Received instructions in both general safety practices for laboratories and specific safety practices for the instrument.
- Read and understood all applicable Material Safety Data Sheets (MSDSs).

Chemical Safety

Chemical Hazard Warnings



WARNING CHEMICAL HAZARD. Before handling any chemicals, refer to the Material Safety Data Sheet (MSDS) provided by the manufacturer, and observe all relevant precautions.



WARNING CHEMICAL HAZARD. All chemicals in the instrument, including liquid in the lines, are potentially hazardous. Always determine what chemicals have been used in the instrument before changing reagents or instrument components. Wear appropriate eyewear, protective clothing, and gloves when working on the instrument.



WARNING CHEMICAL HAZARD. Four-liter reagent and waste bottles can crack and leak. Each 4-liter bottle should be secured in a low-density polyethylene safety container with the cover fastened and the handles locked in the upright position. Wear appropriate eyewear, clothing, and gloves when handling reagent and waste bottles.

About MSDSs

Chemical manufacturers supply current Material Safety Data Sheets (MSDSs) with shipments of hazardous chemicals to *new* customers. They also provide MSDSs with the first shipment of a hazardous chemical to a customer after an MSDS has been updated. MSDSs provide the safety information you need to store, handle, transport, and dispose of the chemicals safely.

Each time you receive a new MSDS packaged with a hazardous chemical, be sure to replace the appropriate MSDS in your files.

Obtaining MSDSs

You can obtain from Applied Biosystems the MSDS for any chemical supplied by Applied Biosystems. This service is free and available 24 hours a day.

To obtain MSDSs:

1. Go to <https://docs.appliedbiosystems.com/msdssearch.html>
2. In the Search field, type in the chemical name, part number, or other information that appears in the MSDS of interest. select the language of your choice, then click **Search**.
3. Find the document of interest, right-click the document title, then select any of the following:
 - **Open** – To view the document
 - **Print Target** – To print the document
 - **Save Target As** – To download a PDF version of the document to a destination that you choose
4. To have a copy of a document sent by fax or e-mail, select **Fax** or **Email** to the left of the document title in the Search Results page, then click **RETRIEVE DOCUMENTS** at the end of the document list.
5. After you enter the required information, click **View/Deliver Selected Documents Now**.

Chemical Safety Guidelines

To minimize the hazards of chemicals:

- Read and understand the MSDSs provided by the chemical manufacturer before you store, handle, or work with any chemicals or hazardous materials. See “About MSDSs” on page xviii.
- Minimize contact with chemicals. When handling chemicals, wear appropriate personal protective equipment such as safety glasses, gloves, and protective clothing. For additional safety guidelines, consult the MSDS.
- Minimize the inhalation of chemicals. Do not leave chemical containers open. Use only with adequate ventilation (for example, a fume hood). For additional safety guidelines, consult the MSDS.
- Check regularly for chemical leaks or spills. If a leak or spill occurs, follow the cleanup procedures recommended in the MSDS.
- Comply with all local, state/provincial, and/or national laws and regulations related to chemical storage, handling, and disposal.

Chemical Waste Safety

Chemical Waste Hazard



WARNING CHEMICAL WASTE HAZARD. Some wastes produced by the operation of the instrument or system are potentially hazardous and can cause injury, illness, or death.

Chemical Waste Safety Guidelines

To minimize the hazards of chemical waste:

- Read and understand the MSDSs for the chemicals in a waste container before you store, handle, or dispose of chemical waste.
- Provide primary and secondary waste containers
- Minimize contact with and inhalation of chemical waste. When handling chemicals, wear appropriate personal protective equipment such as safety glasses, gloves, and protective clothing.
- Handle chemical wastes in a fume hood.
- After you empty a chemical waste container, seal it with the cap provided.
- Dispose of the contents of a waste container in accordance with good laboratory practices and local, state/provincial, and/or national environmental and health regulations.

Waste Profiles

A waste profile for the 3730/3730*xl* DNA Analyzers is provided in the *3730/3730xl DNA Analyzers Site Preparation Guide*.

Waste profiles show the percentage compositions of the reagents in the waste stream generated during installation and during a typical user application, even though the typical application may not be used in your laboratory.

The waste profiles help you plan for the handling and disposal of waste generated by operation of the instrument. Read the waste profiles and all applicable MSDSs before handling or disposing of chemical waste.

Waste Disposal

If potentially hazardous waste is generated when you operate the instrument, you must:

- Characterize (by analysis if necessary) the waste generated by the particular applications, reagents, and substrates used in your laboratory.

- Ensure the health and safety of all personnel in your laboratory.
- Ensure that the instrument waste is stored, transferred, transported, and disposed of according to all local, state/provincial, and/or national regulations.

IMPORTANT! Radioactive or biohazardous materials may require special handling, and disposal limitations may apply.

Electrical Safety

Shock Hazards



DANGER

ELECTRICAL SHOCK HAZARD. Severe electrical shock, which could cause physical injury or death, can result from working on an instrument when the high-voltage power supply is operating. To avoid electrical shock, disconnect the power supply to the 3730/3730xI DNA Analyzers, unplug the power cord, and wait at least 1 minute before working on the instrument



DANGER

ELECTRICAL SHOCK HAZARD. Severe electrical shock can result from operating the 3730/3730xI DNA Analyzers without its instrument panels in place. Do not remove instrument panels. High-voltage contacts are exposed when instrument panels are removed from the instrument.

Fuses



DANGER

ELECTRICAL SHOCK HAZARD. Improper fuses or high-voltage supply can damage the instrument wiring system and cause a fire. Before turning on the 3730/3730xI DNA Analyzers, verify that the fuses are properly installed and that the instrument voltage matches the power supply in your laboratory.



WARNING

FIRE HAZARD. For continued protection against the risk of fire, replace fuses only with fuses of the type and rating specified for the instrument.

Power Supply



DANGER

ELECTRICAL HAZARD. Grounding circuit continuity is vital for the safe operation of equipment. Never operate equipment with the grounding conductor disconnected.



DANGER

ELECTRICAL HAZARD. Use properly configured and approved line cords for the voltage supply in your facility.



DANGER

ELECTRICAL HAZARD. Plug the system into a properly grounded receptacle with adequate current capacity.



DANGER

ELECTRICAL HAZARD. A short circuit can result from working on an instrument when the power supply is operating. To avoid a short circuit, turn off the instrument before servicing the instrument.

Overvoltage Rating

The 3730/3730xI DNA Analyzers system has an installation (overvoltage) category of II, and is classified as portable equipment

Physical Hazard Safety

Ultraviolet Light Sources  **WARNING ULTRAVIOLET LIGHT HAZARD.** Exposure to ultraviolet radiation can cause blindness or permanent eye damage. To prevent eye injury, change the detector sensitivity from the ultraviolet to the visible range (520 nm) before beginning any detection or maintenance procedures. Always wear protective UV-absorbing glasses when looking into the detector. Turn off the lamp power before removing it from its fixture.

 **WARNING ULTRAVIOLET LIGHT HAZARD.** Looking directly at a UV light source can cause serious eye damage. Never look directly at a UV light source and always prevent others from UV exposure. Follow the manufacturer's recommendations for appropriate protective eyewear and clothing.

Compressed Gases  **WARNING PHYSICAL HAZARD. Nonflammable compressed gas.** Contents are under pressure. Receive proper training on the handling of compressed gases before use. Exposure to rapidly expanding gas may cause frostbite. High concentrations of vapors in the immediate area can displace oxygen and cause asphyxiation. Use only in areas with adequate ventilation. Read the MSDS, and follow the handling instructions. Wear appropriate protective eyewear, clothing, and gloves.

 **WARNING EXPLOSION HAZARD.** Pressurized gas cylinders are potentially explosive and can cause severe injury if not handled properly. Always cap the gas cylinder when it is not in use and attach it firmly to the wall or gas cylinder cart with approved brackets or chains.

Moving Parts  **WARNING PHYSICAL INJURY HAZARD.** Moving parts can crush and cut. Keep hands clear of moving parts while operating the 3730/3730xl DNA Analyzers. Disconnect power before servicing the 3730/3730xl DNA Analyzers.

 **DANGER PHYSICAL INJURY HAZARD.** Do not operate the 3730/3730xl DNA Analyzers without the arm shield in place. Keep hands out of the deck area when the 3730/3730xl DNA Analyzers is spotting.

Solvents and Pressurized Fluids  **WARNING PHYSICAL INJURY HAZARD.** Always wear eye protection when working with solvents or any pressurized fluids.

 **WARNING PHYSICAL INJURY HAZARD.** To avoid hazards associated with high-pressure fluids in polymeric tubing:

- Be aware that PEEK™ tubing is a polymeric material. Use caution when working with any polymer tubing that is under pressure.
- Always wear eye protection when in proximity to pressurized polymer tubing.
- Extinguish all nearby flames if you use flammable solvents.
- Do not use PEEK tubing that has been severely stressed or kinked.
- Do not use PEEK tubing with tetrahydrofuran or concentrated nitric and sulfuric acids.
- Be aware that methylene chloride and dimethyl sulfoxide cause PEEK tubing to swell and greatly reduce the rupture pressure of the tubing.

- Be aware that high solvent flow rates (~40 mL/min) may cause a static charge to build up on the surface of the tubing. Electrical sparks may result.

Biological Hazard Safety



DANGER BIOHAZARD. Biological samples such as tissues, body fluids, and blood of humans and other animals have the potential to transmit infectious diseases. Read and follow the guidelines published in:

- U.S. Department of Health and Human Services guidelines published in *Biosafety in Microbiological and Biomedical Laboratories* (stock no. 017-040-00547-4)
- Occupational Safety and Health Standards, Toxic and Hazardous Substances (29 CFR §1910.1030).

Additional information about biohazard guidelines is available at:

<http://www.cdc.gov>

Follow all applicable local, state/provincial, and/or national regulations. Wear appropriate protective eyewear, clothing, and gloves.

Laser Safety

Laser Classification

The 3730/3730xl DNA Analyzers uses a laser. Under normal operating conditions, the instrument laser is categorized as a Class I laser. When safety interlocks are disabled during certain servicing procedures, the laser can cause permanent eye damage, and, therefore, is classified under those conditions as a Class IIIb laser.

The 3730/3730xl DNA Analyzers laser has been tested to and complies with the “Radiation Control for Health and Safety Act of 1968 Performance Standard CFR 1040.”

The 3730/3730xl DNA Analyzers laser has been tested to and complies with standard EN60825-1, “Radiation Safety of Laser Products, Equipment Classification, Requirements, and User’s Guide.”

Laser Safety Requirements

To ensure safe laser operation:

- The system must be installed and maintained by an Applied Biosystems Technical Representative.
- All instrument panels must be in place on the instrument while the instrument is operating. When all panels are installed, there is no detectable radiation present. If any panel is removed when the laser is operating (during service with safety interlocks disabled), you may be exposed to laser emissions in excess of the Class I rating.
- Do not remove safety labels or disable safety interlocks.

Additional Laser Safety Information

Refer to the user documentation provided with the laser for additional information on government and industry safety regulations.



WARNING

LASER HAZARD. Lasers can burn the retina causing permanent blind spots. Never look directly into the laser beam. Remove jewelry and other items that can reflect the beam into your eyes. Do not remove the instrument top or front panels. Wear proper eye protection and post a laser warning sign at the entrance to the laboratory if the top or front panels are removed for service.



WARNING

LASER BURN HAZARD. An overheated laser can cause severe burns if it comes in contact with the skin. DO NOT operate the laser when it cannot be cooled by its cooling fan. Always wear appropriate laser safety goggles.

Bar Code Scanner Laser Safety

Laser Classification

The bar code scanner included with the 3730/3730xl DNA Analyzers is categorized as a Class II laser.

Laser Safety Requirements

Class II lasers are low-power, visible-light lasers that can damage the eyes. Never look directly into the laser beam. The scanner is designed to prevent human access to harmful levels of laser light during normal operation, user maintenance, or during prescribed service operations.



WARNING

LASER HAZARD. Class II lasers can cause damage to eyes. Avoid looking into a Class II laser beam or pointing a Class II laser beam into another person's eyes.

Computer Workstation Safety

Correct ergonomic configuration of your workstation can reduce or prevent effects such as fatigue, pain, and strain. Minimize or eliminate these effects by configuring your workstation to promote neutral or relaxed working positions.



CAUTION

MUSCULOSKELETAL AND REPETITIVE MOTION HAZARD. These hazards are caused by potential risk factors that include but are not limited to repetitive motion, awkward posture, forceful exertion, holding static unhealthy positions, contact pressure, and other workstation environmental factors.

- Use equipment that comfortably supports you in neutral working positions and allows adequate accessibility to the keyboard, monitor, and mouse.
- Position the keyboard, mouse, and monitor to promote relaxed body and head postures.

Safety and Electromagnetic Compatibility (EMC) Standards

This section provides information on:

- U.S. and Canadian Safety Standards
- European Safety and EMC Standards
- Australian EMC Standards

U.S. and Canadian Safety Standards



This instrument has been tested to and complies with standard UL 3101-1, “Safety Requirements for Electrical Equipment for Laboratory Use, Part 1: General Requirements.”

This instrument has been tested to and complies with standard CSA 1010.1, “Safety Requirements for Electrical Equipment for Measurement, Control, and Laboratory Use, Part 1: General Requirements.”

European Safety and EMC Standards



Safety

This instrument meets European requirements for safety (Low Voltage Directive 73/23/EEC). This instrument has been tested to and complies with standards EN 61010-1, “Safety Requirements for Electrical Equipment for Measurement, Control and Laboratory Use, Part 1: General Requirements” and EN 61010-2-010, “Particular Requirements for Laboratory Equipment for the Heating of Materials.”

EMC

This instrument meets European requirements for emission and immunity (EMC Directive 89/336/EEC). This instrument has been tested to and complies with standard EN 61326 (Group 1, Class B), “Electrical Equipment for Measurement, Control and Laboratory Use – EMC Requirements.”

Australian EMC Standards



This instrument has been tested to and complies with standard AS/NZS 2064, “Limits and Methods Measurement of Electromagnetic Disturbance Characteristics of Industrial, Scientific, and Medical (ISM) Radio-frequency Equipment.”

Performing a Run

1

In This Chapter	Instrument Parts	1-2
	A Typical Run	1-3
	Working with Samples and Plate Assemblies	1-5
	Starting the Applied Biosystems 3730/3730xl System	1-9
	Preparing the Instrument	1-14
	Calibrating the Instrument	1-23
	Placing a Plate in the Stacker	1-24
	Running the Instrument	1-26
	Default Load Maps	1-28
	Monitoring a Run	1-43
	Working with Data in The Run History View	1-51
	Viewing Analyzed Data	1-60

Instrument Parts

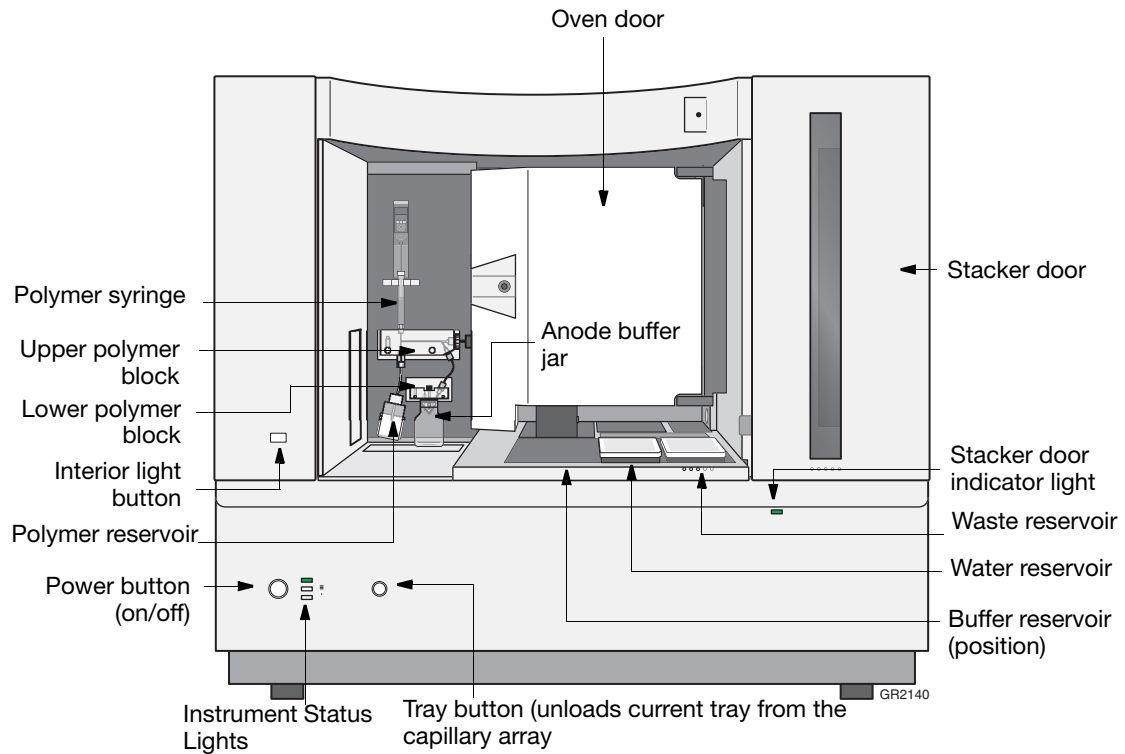
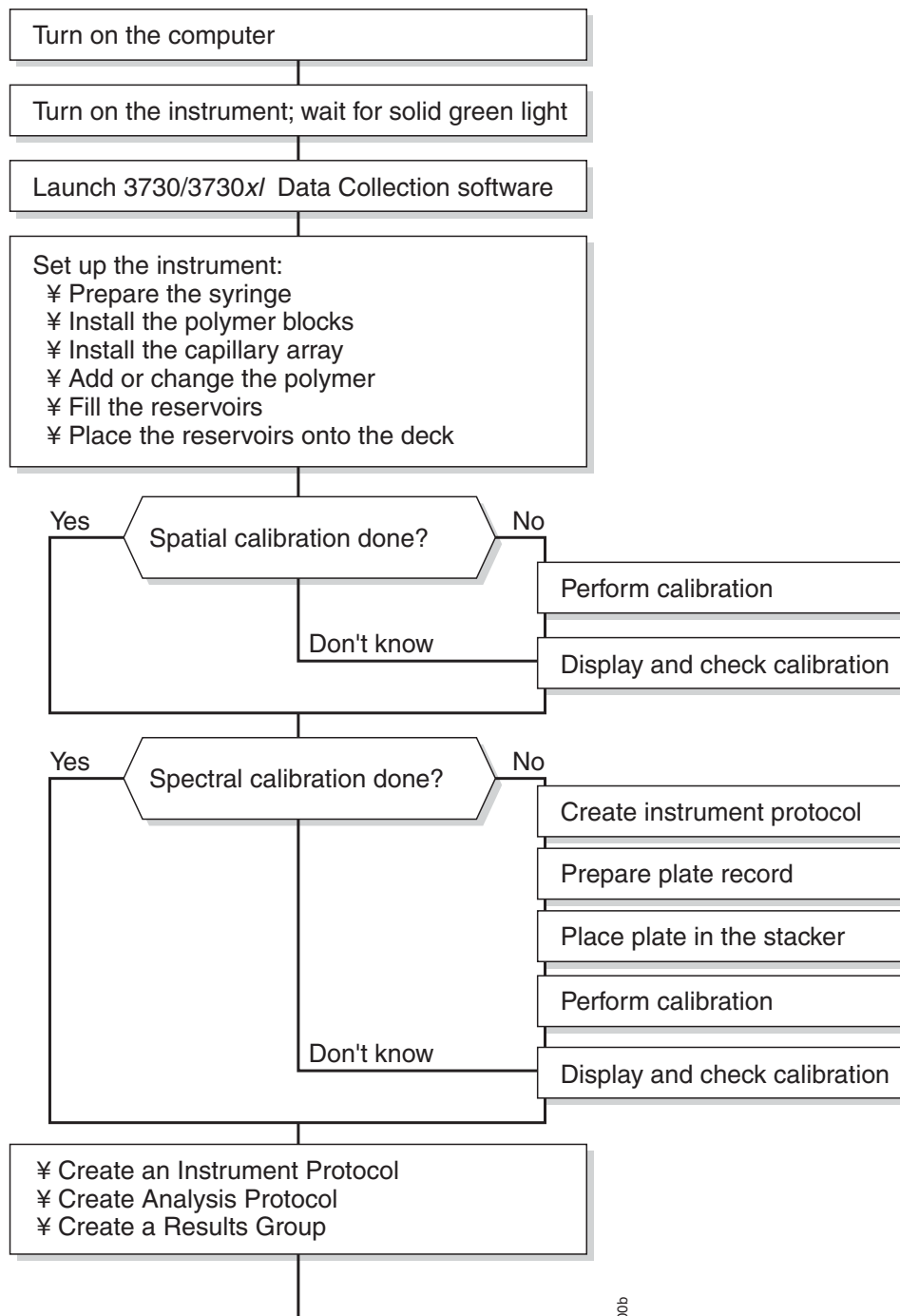

Figure 1-1 Parts of the 3730/3730xl DNA Analyzers

A Typical Run

Flowchart of a Typical Run This flowchart provides an overview of the steps required to perform a run on the Applied Biosystems 3730/3730xl DNA Analyzers.



Continued on next page

GR22005

Figure 1-2 Typical Run Flowchart, Part I

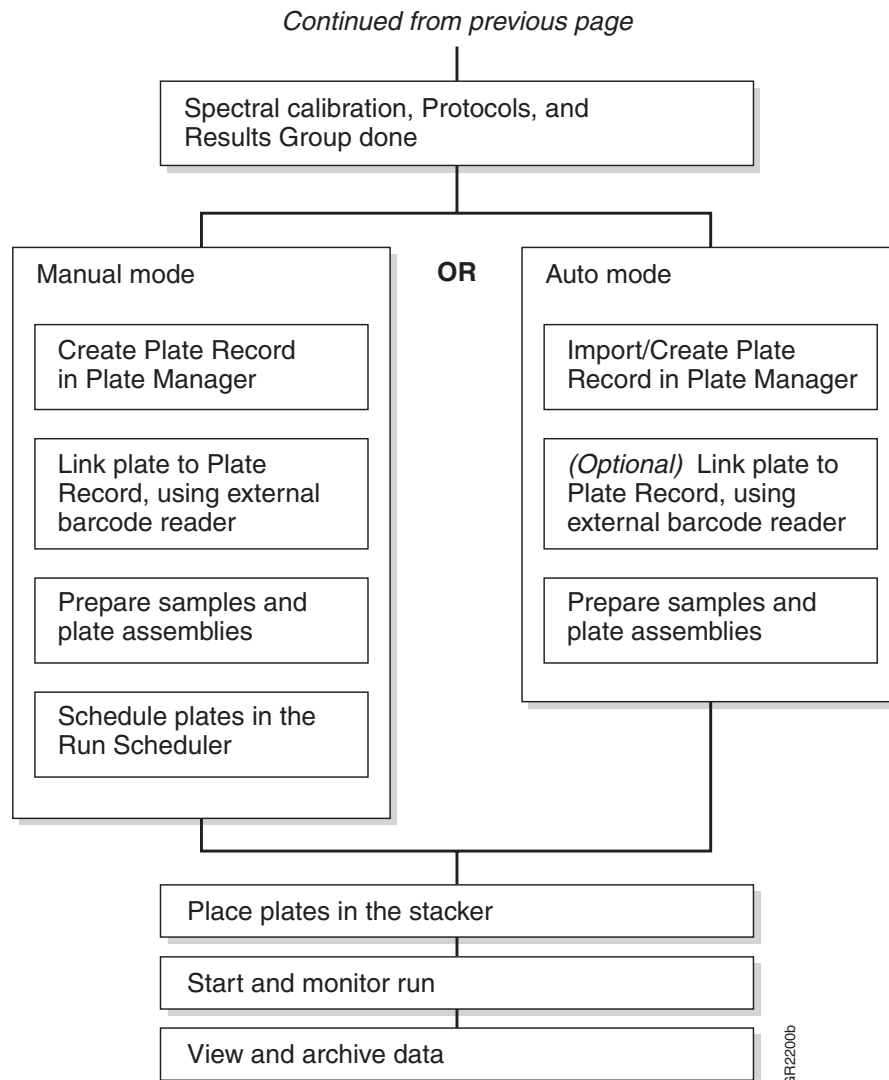

Figure 1-3 Typical Run Flowchart, Part II

Working with Samples and Plate Assemblies

Preparing Samples

References for Sample Preparation

For information on required materials, sample preparation, and plate centrifugation, see:

- **Sequencing:** *Applied Biosystems 3730/3730xl DNA Analyzer Chemistry Guide (P/N 4331467)*.
- **Fragment analysis:** See this guide, page 3-5.

Checking the Plate

After centrifuging the plate of samples, ensure each sample is positioned at the bottom of its tube or well.

To check the plate of samples:

1. Hold the plate up to a light source. Your samples should:

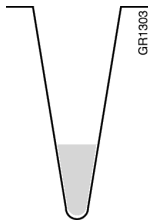
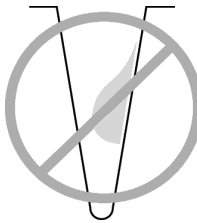
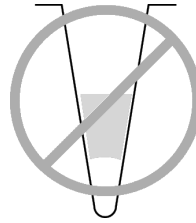
Look like this...	Not look like this...	Not look like this...
 <p>The sample is positioned correctly in the bottom of the well.</p>	 <p>The sample lies on the side wall because the plate was not centrifuged.</p>	 <p>An air bubble lies at the bottom of the well because the plate was not:</p> <ul style="list-style-type: none"> • Centrifuged with enough force, or • Centrifuged for enough time

2. If any sample is not positioned at the bottom of the well, recentrifuge the plate.

Working with Plate Assemblies

Overview You have two options to prevent sample evaporation:

- Use septa with a plate
- Use a heat-sealed film with a plate.

 **CAUTION** Only use a gray base with a heat-sealed film and only use a black base with septa.

96-well Plate Assembly Using Septa

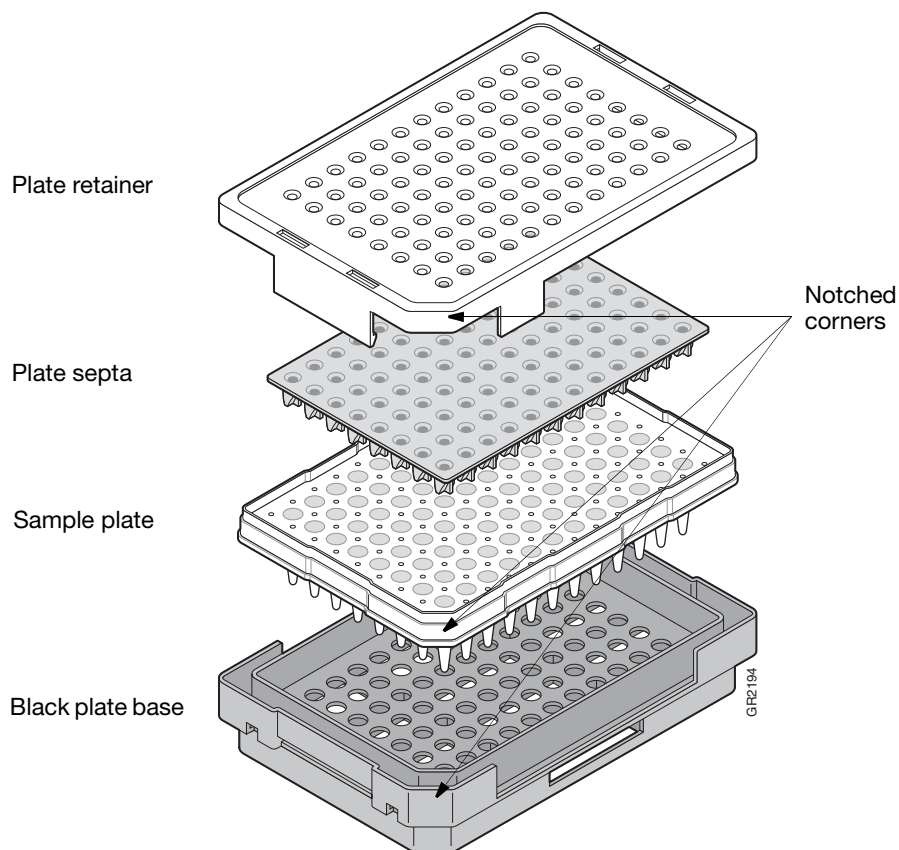

Figure 1-4 Septa Based Plate Assembly

384-well Plate Assembly Using a Heat-sealed Plate

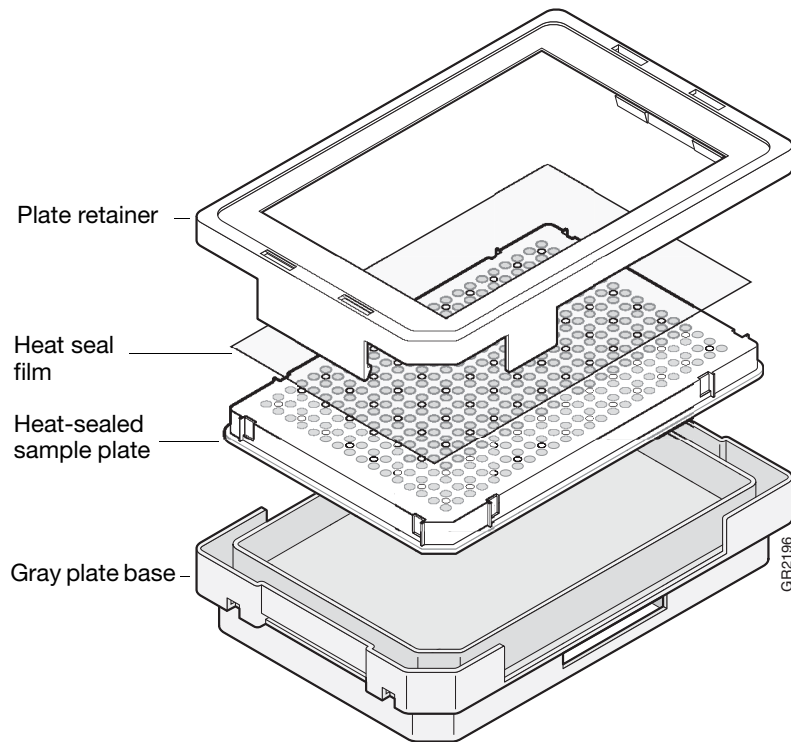

Figure 1-5 Heat Sealed Film Based Plate Assembly

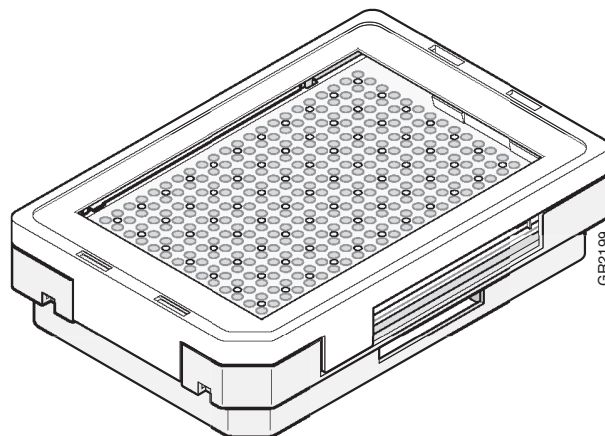

Figure 1-6 Assembled plate components

Preparing a Plate Assembly Using Septa

To prepare a plate assembly using a septum:

1. Secure a clean and dry plate septum on the sample plate.

IMPORTANT!

- Never use warped plates.
 - Ensure the plate septum lies flat on the plate.
 - Ensure that the plate retainer and the septum holes are aligned. Damage to the array tips may occur if they are not aligned (see figure 1-7 below).
 - Do not denature plate with septa in place.
2. Place the sample plate into the plate base.
 3. Snap the plate retainer onto the plate and then into the black plate base.
 4. Ensure the plate retainer holes are aligned with the holes in the septum strip.

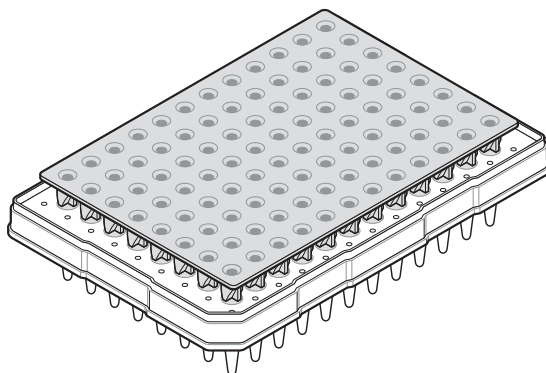

Figure 1-7 Align the plate sample holes with the septum holes.

Preparing a Plate Assembly Using a Heat-sealed Plate

The following equipment is needed to heat-seal plates:

- Thermal plate sealer
- 3-mil thick plastic heat seal film (P/N 4337570). The film is 1-mil thick after heating.



CAUTION Do not use metallized heat seal film. They may damage the instrument's piercing needles.

Starting the Applied Biosystems 3730/3730xl System

About Naming the Computer



CAUTION

Do not rename the computer once Applied Biosystems 3730/3730xl DNA Analyzer Data Collection Software has been installed. Doing so may cause the 3730/3730xl Data Collection software to malfunction.

Starting the Computer

Starting the Computer Workstation

IMPORTANT! Start the computer workstation before starting the Applied Biosystems 3730/3730xl DNA Analyzers.

To start the computer workstation:

1. Turn on the monitor.
2. Power on the computer.
The computer boots and then the Begin Logon dialog box displays.
3. Enter the user name and password.
 - The default user name for the workstation is **3730User**. Do not change this user name.
 - There is no default password. If you would like to use a password, your system administrator can create one.
 - If the computer is connected to a network, you do not need to log on to the network before starting the instrument.

Starting the Instrument

Starting the Instrument

To start the 3730/3730xl DNA Analyzer:

1. On the instrument, ensure that the:
 - Oven door is closed
 - Instrument door is closed
 - Stacker drawer is closed
 - Buffer, water, and waste trays are loaded
2. On the computer, ensure that the:
 - Computer is powered on (see “Starting the Computer” on page 1-9)
 - Microsoft® Windows® 2000 operating system has loaded

IMPORTANT! The computer must be on and running the Windows 2000 operating system before starting the instrument because the instrument must copy the firmware from the computer.

3. Turn on the instrument by pressing the on/off power button on the front of the instrument. Ensure the green status light is on and constant before proceeding (this takes about 1 minute).
 - While the instrument is booting up and performing self-checks, the yellow status light flashes.
 - If a solid green light does not display, launch the 3730/3730xl software and look at the event log messages (see page 1-47). The event log messages are located at:

E:\AppliedBiosystems\UDC\Data Collection\Data\ga3730\Instrument Name

Note: If the instrument door is open during power-on, the yellow light flashes indicating that the boot-up has not completed. Close the instrument door and wait until the solid green status light displays (this takes 15-20 seconds).

Starting the 3730/3730xl Data Collection Software

To start the 3730/3730xl Data Collection software:

1. Select **Start > Programs > AppliedBiosystems > Unified Data Collection > Run Unified Data Collection v1.0 software.**

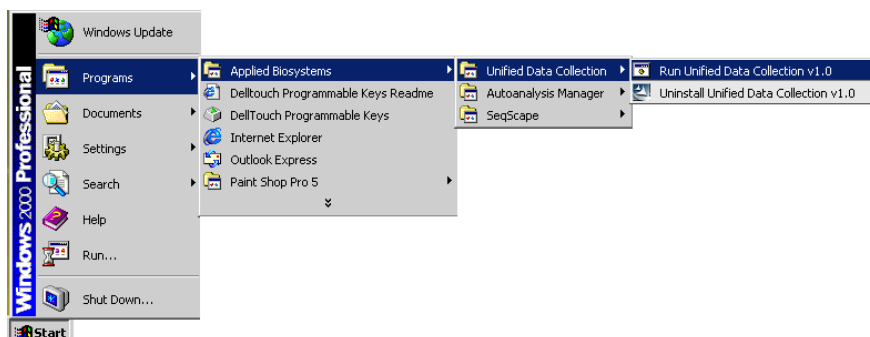

The Service Console displays. By default, all applications are off as indicated by the red circles. However, they launch automatically with the 3730/3730xl Data Collection software.

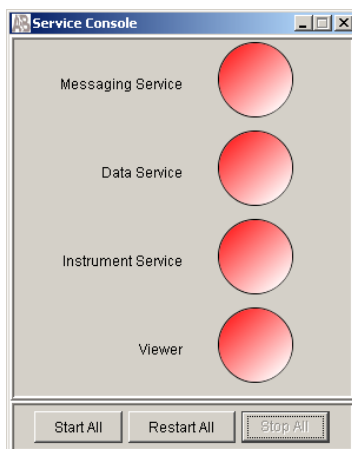

Figure 1-8 Service Console with all applications off

As each application automatically activates, the red circles (off) change to yellow triangles (activating), to green squares (on) when they are fully functional.

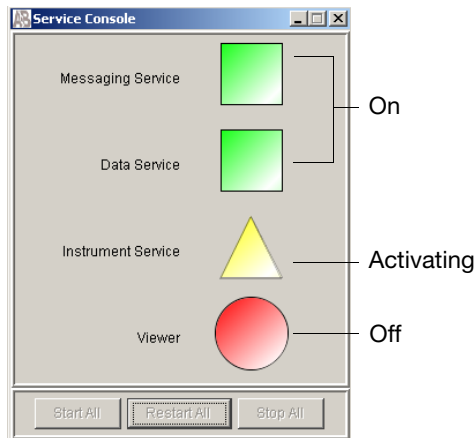

Figure 1-9 Service Console with applications activating

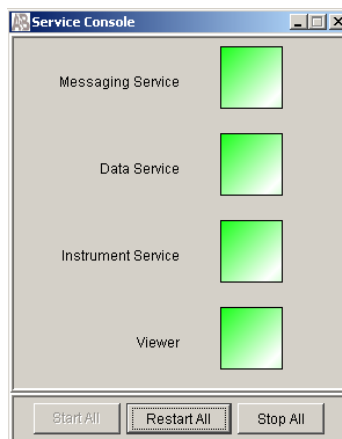
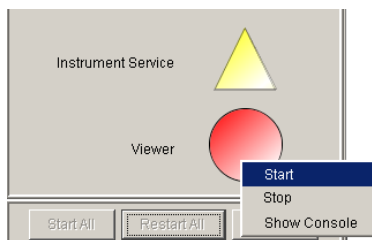

Figure 1-10 Service Console with all applications on



Right-click an object (circle, square, or triangle) to display a menu:

- a. Click Start to start an application. Start is disabled if the application is already running.
- b. Click Stop to stop an application. Stop is disabled if the application is already stopped or just starting.

Note: Click Show Console to display the Console Viewer window

IMPORTANT! If you use the right-click method to manually start the applications, they must be started in order from top to bottom, and you must wait until an application is running (green square) before starting the application below it.

When all the applications are running (all green squares—this could take several minutes), the Data Collection Viewer window displays.

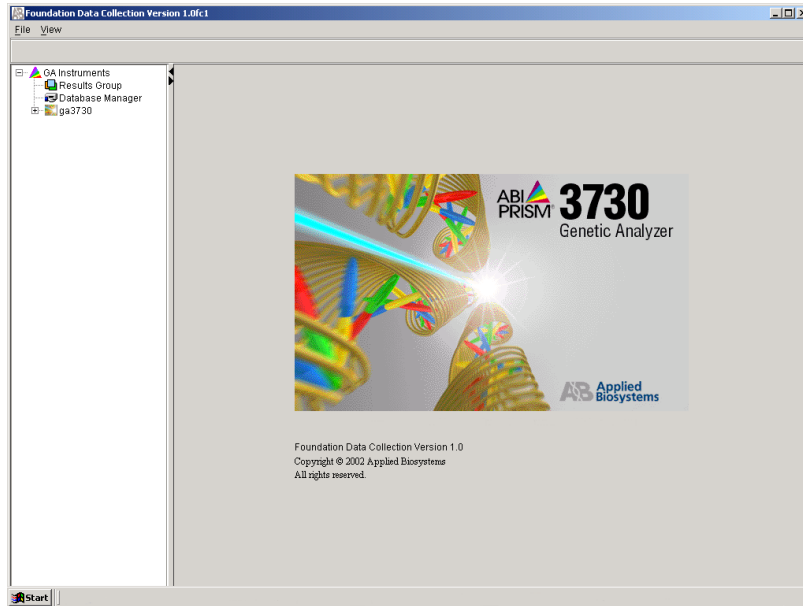

Figure 1-11 Data Collection Viewer Window

2. Click the + to expand subfolders in the left window pane. All application folders—except for Run History—are now visible and ready to access.

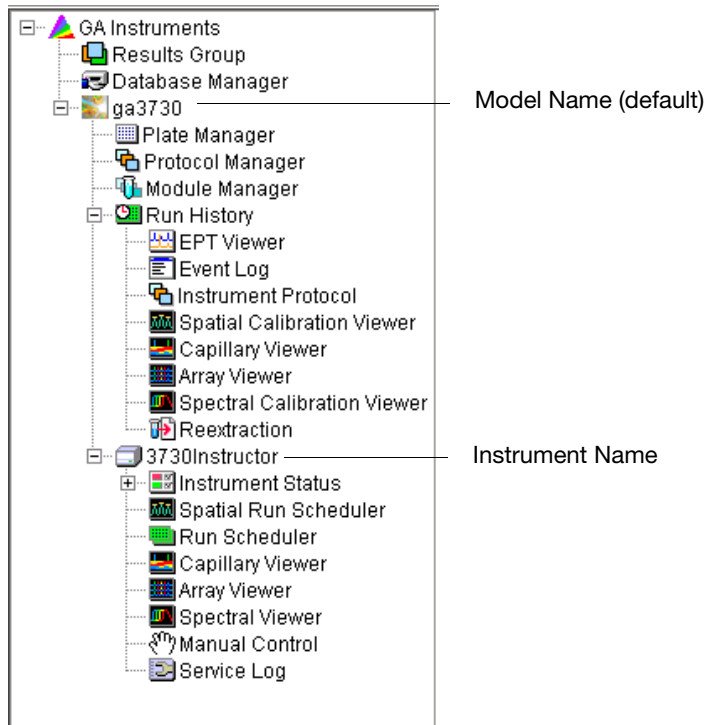

Figure 1-12 Expanded Tree in Left Pane

Preparing the Instrument

Attaching the Polymer Blocks

To attach the polymer blocks to the instrument:

1. Clean the polymer blocks and the tubing as instructed on page 5-22.
2. Connect the tubing between the two blocks before attaching the blocks to the instrument:
 - a. Insert one ferrule into the upper polymer block and rotate clockwise until finger tight.
 - b. Insert the other ferrule into the lower polymer block and rotate clockwise until finger tight.

IMPORTANT! To ensure that you are correctly attaching the upper polymer block to the instrument, make sure that the check valve on the bottom of the block is facing down (as shown below).

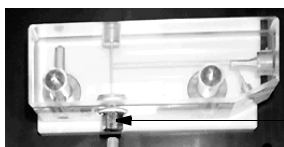

check valve at bottom of the upper block, facing down toward the lower block.

Figure 1-13 Upper Polymer Block Check Valve

Do not overtighten.

3. Push the upper polymer block and the lower polymer block onto their respective guide pins at the same time (as shown below). Push both blocks at the same time, about half way down the guide pins, toward the instrument wall.

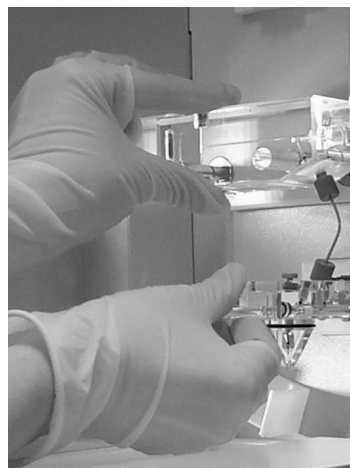
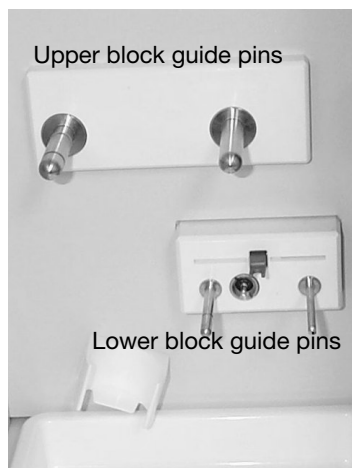

Push both blocks at the same time, about half way down the guide pins, toward the instrument wall.

Figure 1-14 Attaching the Polymer Blocks to the Instrument, Part I

4. Finish by pushing each block, individually, until each is flush against the instrument wall (as shown below).

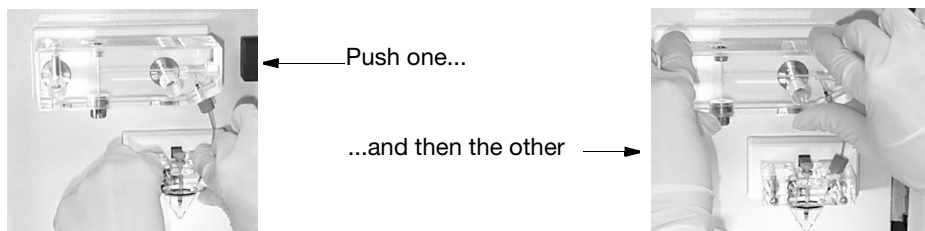

Figure 1-15 Attaching the Polymer Blocks to the Instrument, Part II

5. Install a clean drip tray.

Preparing and Installing the Syringe

IMPORTANT! Wear gloves when handling the capillary array, glass syringe, septa, and buffer reservoirs.

Please refer to “Syringe Maintenance” on page 5-18 for instructions on preparing and installing the syringe.

Installing a New Capillary Array

To install the capillary array:

1. Close the instrument door.
2. Press the Tray button.
3. Select **Wizards > Install Capillary Array Wizard**.
4. Follow the directions in the wizard.

Please refer to “Installing or Removing the Capillary Array Using the Wizard” on page 5-13.

IMPORTANT! You must run the Install Capillary Array Wizard in order to proceed to a spatial calibration.

IMPORTANT! You must use the capillary array wizard when installing a new capillary array as KB Basecaller selects the proper calibration/mobility based on the instrument wizard-installed capillary settings. The incorrect capillary settings may result in KB Basecaller using incorrect calibration files.

Adding and Changing the Polymer



CAUTION CHEMICAL HAZARD. POP-7 polymer may cause eye, skin, and respiratory tract irritation. Please read the MSDS, and follow the handling instructions. Wear appropriate protective eyewear, clothing, and gloves. Use for research and development purposes only.

IMPORTANT! You must check the polymer level as the polymer bottle does not have a liquid level sensor.

Note: If you want to track the polymer lot number, run the Change Polymer wizard to enter the number into the database.

Determine whether to add or change the polymer on the instrument before proceeding with instrument preparation.

For the procedure, refer to “Adding and Changing the Polymer” on page 5-10.

If polymer on the instrument is...	Then...
less than 1 week old, and sufficient in quantity to complete your runs*	Ensure there are no air bubbles, and then proceed with instrument preparation. Note: To remove air bubbles, see page 5-28.
greater than 1 week old, or insufficient in quantity to complete your runs	Clean the blocks and change the polymer by following the Change Polymer wizard. For instructions, see page 5-9.
Note: Perform a daily visual inspection of polymer blocks and all lines for bubbles.	

*A 96-capillary run uses 200–250 μL of polymer, and a 48 capillary run uses 125 μL of polymer. A minimum of 10 mL of polymer is recommended for the instrument to operate.

Preparing Buffer and Filling Reservoirs

Required Materials The following materials are required to prepare 1X running buffer:

- 3730/3730xl Buffer with EDTA, 10X (P/N 4335613)
- Quality deionized water
- Graduated cylinder, 200 mL
- Gloves

Preparing the 1X Running Buffer



CAUTION CHEMICAL HAZARD. Running Buffer with EDTA. Please read the MSDS, and follow the handling instructions. Wear appropriate protective eyewear, clothing, and gloves.

To prepare running buffer:

1. Add 12 mL of 10X running buffer with EDTA into a graduated cylinder.
2. Add 108 mL (qs) deionized water to bring the total volume to 120 mL.
3. Mix well and set aside.

Storing the Buffer

The 1X running buffer can be stored at 2 to 8 °C for up to 1 month. Bring buffer to room temperature before using.

Replacing the Buffer

Replace the 1X running buffer in the anode buffer reservoir and the cathode buffer reservoir every 24 hours, or before each batch of runs.

IMPORTANT! Failing to replace buffer may lead to loss of resolution and data quality.

Note: Replenishing buffer and placing the plate requires that the autosampler be in the forward position, with the capillary tips removed from the buffer solution. Do not leave the autosampler in this position because the capillaries can dry out. For example, you can use manual control to move the water reservoir to the capillaries while you are placing the buffer in the buffer reservoir.

Filling the Water and Cathode Buffer Reservoirs

CAUTION Wear gloves while performing the following procedure, and any other time you handle the capillary array, glass syringe, septa, or buffer reservoirs.

To fill the water, waste, and cathode buffer reservoirs:

1. Close the instrument door.
2. Press the Tray button on the outside of the instrument to bring the autosampler to the forward position.

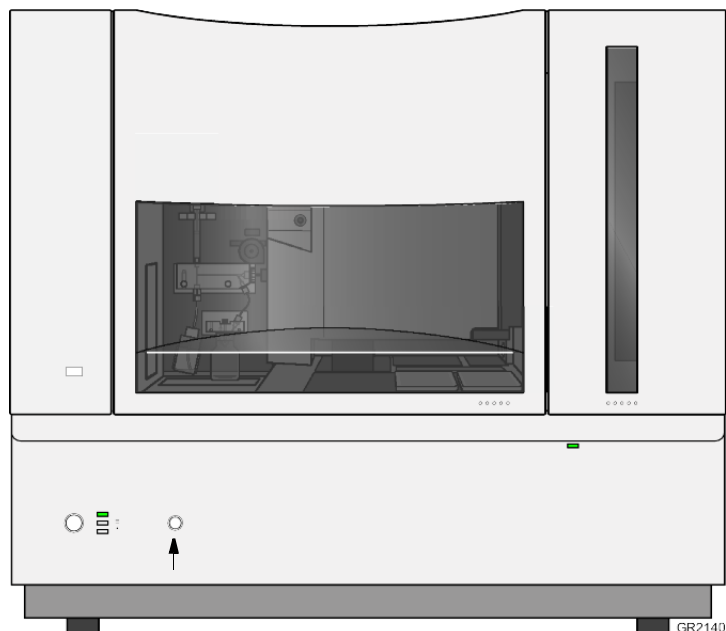

Figure 1-16 Instrument Tray Button

3. Wait until the autosampler has stopped moving, then open the door.
4. Fill the reservoirs as follows:
 - a. Rinse the cathode reservoir with deionized water and then add 80 mL of 1X running buffer.
 - b. Rinse the water and waste reservoirs with deionized water.
 - c. Fill the water and waste reservoirs with 80 mL of high quality deionized water.

5. Assemble the reservoirs as shown below.

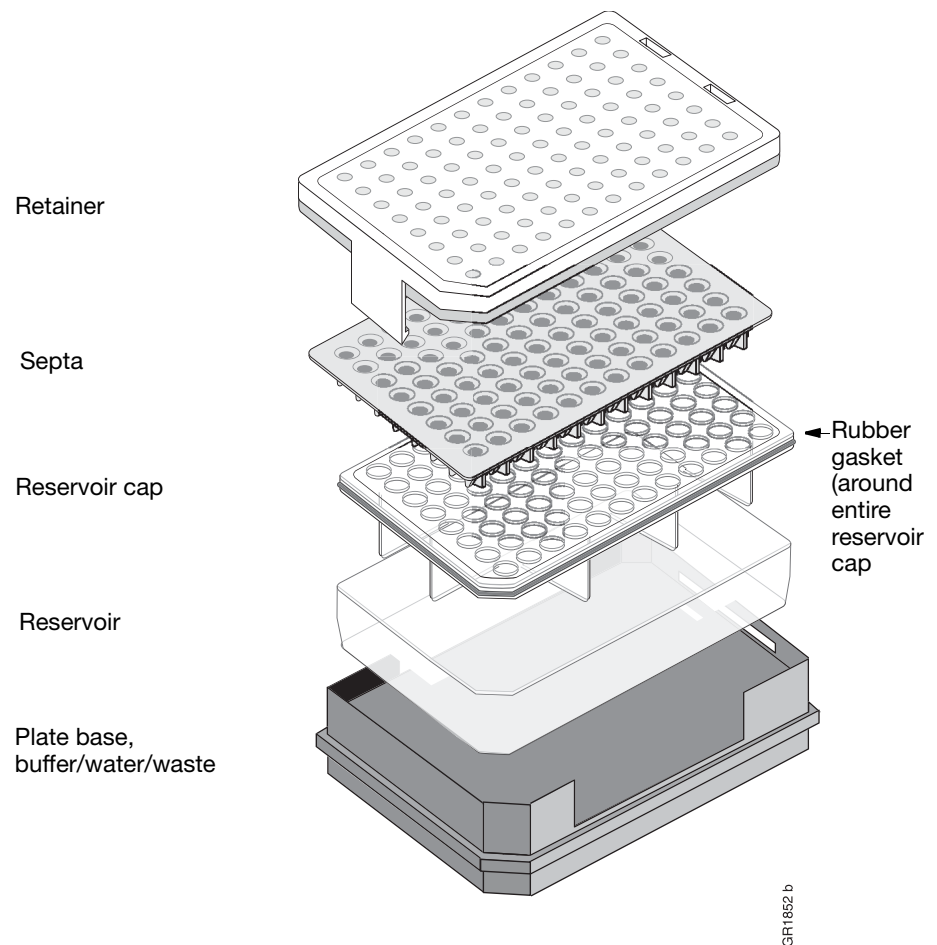

Figure 1-17 Reservoir Assembly



- a. Ensure that the septa fit snugly and flush on the tops of the reservoirs in order to prevent damaging the capillary tips.
 - b. Ensure that the rubber gasket around the edge of the reservoir cap is seated completely.
 - c. Ensure that retainer clip holes are aligned with the septa holes.
6. Dry the outside of the reservoirs using a lint-free wipe.

7. Connect the running buffer plate base cord into the heater outlet within the instrument (see Figure 1-18 below).

Hint: It may help to temporarily place the buffer tray in the water tray position while you plug in the heater cord. Make sure the cord is not twisted. When the heater cord is plugged into the instrument, return the buffer tray to the buffer position.

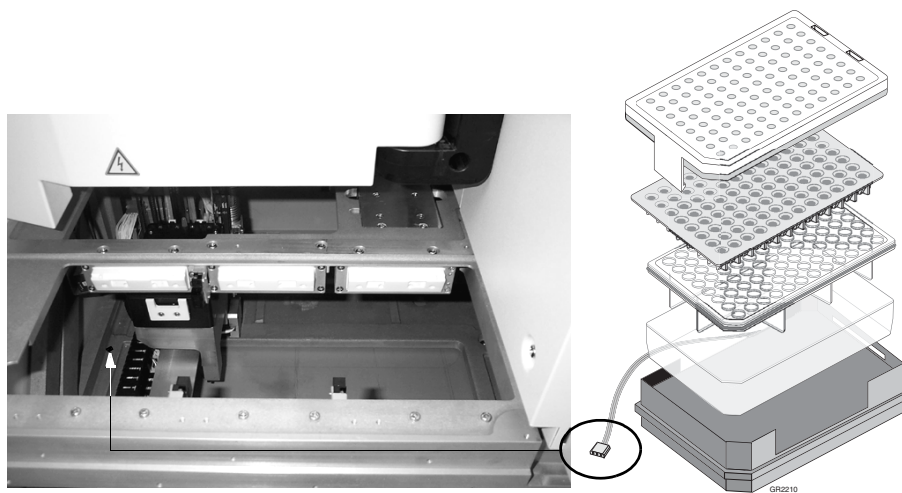



Figure 1-18 Connecting the Running Buffer Plate to the heater outlet

8. Place the reservoirs into position on the plate deck as shown below.

9.  **CAUTION** Place the reservoirs into the instrument in this order:
- Buffer reservoir first (plug in the cord to the heating element (see graphic above)).
 - Water reservoir second
 - Waste reservoir third

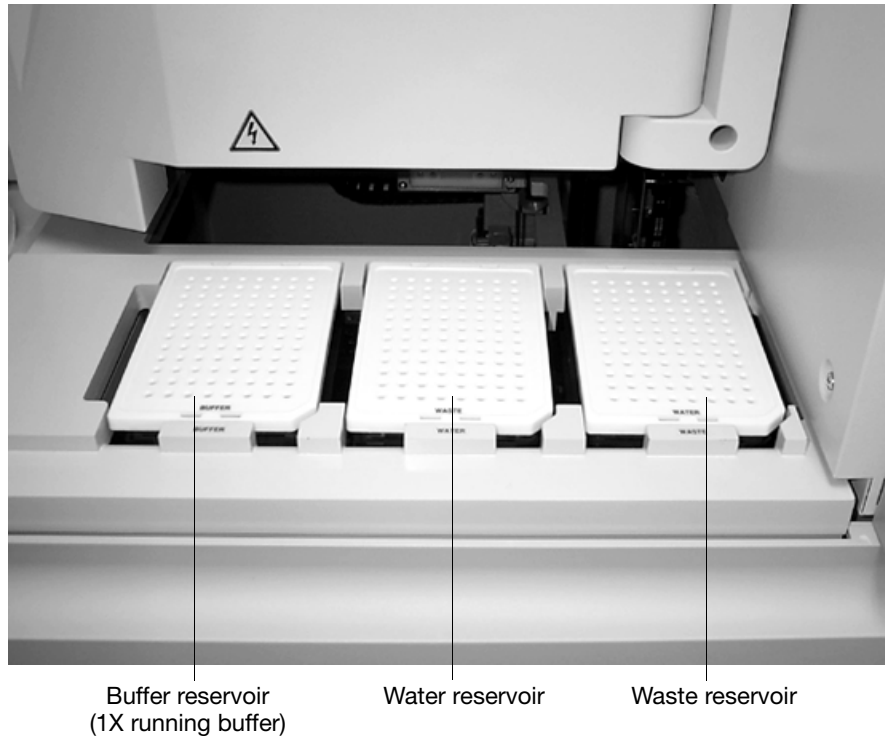

Figure 1-19 Reservoirs in Place

Filling the Anode Buffer Reservoir

Change the anode buffer:

- Before each group of scheduled runs, or at least every 24 hours
- Every time you fill the polymer block with new polymer

To fill the anode buffer reservoir to the fill line with 1X running buffer:

1. Remove the anode buffer reservoir by firmly pulling down while twisting slowly.
2. Clean and rinse the reservoir with deionized water, and then rinse with buffer.
3. Fill the reservoir with 38mL of fresh 1X running buffer.

- Put the anode buffer reservoir on the instrument.

Note: The meniscus should line up just under the red fill line when installed on the instrument (see graphic below).

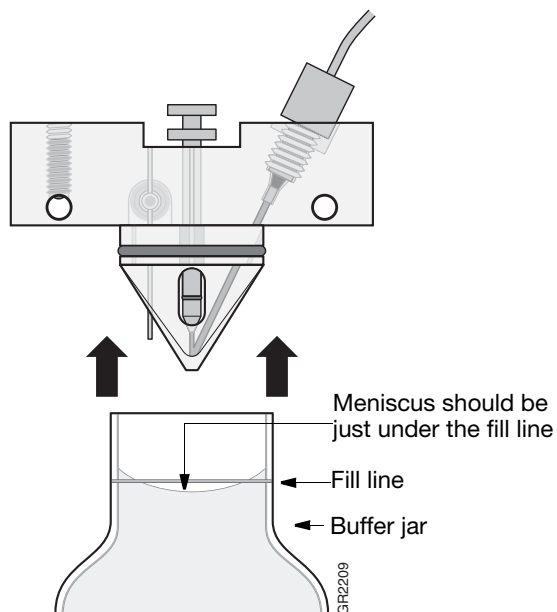

Figure 1-20 Placing the anode buffer reservoir on the instrument

- If the reservoir fills completely as polymer is added, perform this procedure to discard and replace the running buffer.

Note:

- The reservoir could fill during bubble clearing.
- Replace buffer if excess polymer is expelled into the anode jar.

Calibrating the Instrument

Spatial Calibration

- How and When to Perform** It is important to use the capillary install wizard if:
- It is the first time the array is being used
 - The computer has been reimaged
 - The Applied Biosystems 3730/3730xl DNA Analyzer Data Collection Software has been uninstalled and then reinstalled

A spatial calibration must be performed after each time you:

- Install a capillary array
- Replace a capillary array with a new one
- Move the detection cell. For example, after replacing the capillary array
- Open the detection block door
- Move the instrument

For instructions, see “Spatial Calibration” on page 4-2.

Spectral Calibration

- When to Perform** A spectral calibration must be performed:
- Whenever you use a new dye set on the instrument
 - After the laser has been realigned by a service engineer
 - After the CCD camera has been realigned/replaced by a service engineer
 - If you begin to see pull-up and/or pull-down peaks consistently
 - If you switch between 96 and 48 capillary arrays

For instructions, see “Spectral Calibration” on page 4-9.

Placing a Plate in the Stacker

To place a plate in the Stacker:

1. Pull open the stacker drawer. The stacker light flashes green.
2. Open the metal door of the In Stacker tower.

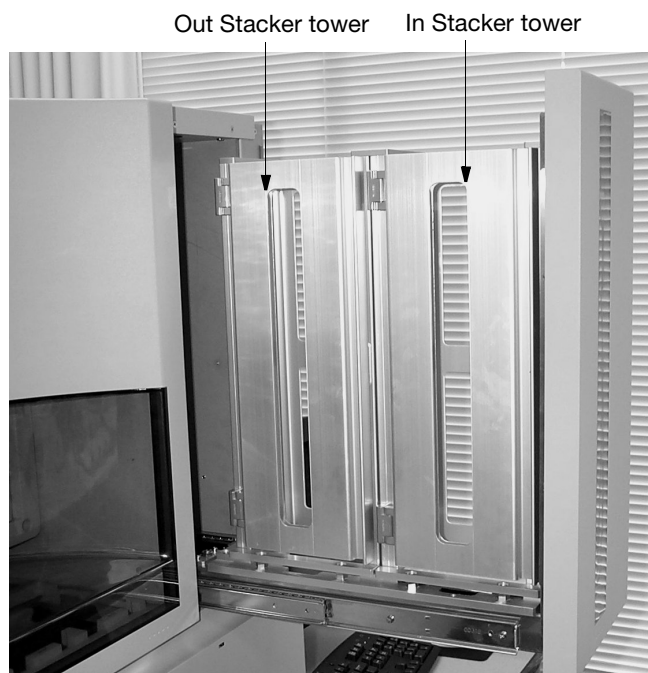
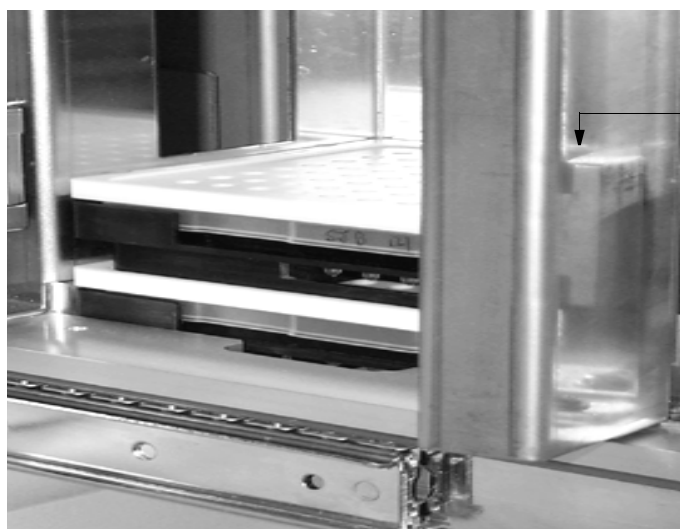

Figure 1-21 Front view of the Stacker Towers

IMPORTANT! Ensure that the plate assembly fits flat in the stacker. Failure to do so may result in the gripper improperly grabbing plates.



Notched corner of the plate assembly is placed in the right, rear corner of the Stacker (when looking from the side).

Figure 1-22 Plate Placement in the In Stacker Tower

- Place up to 16 (max) plates into the stacker. The bottom plate runs first.

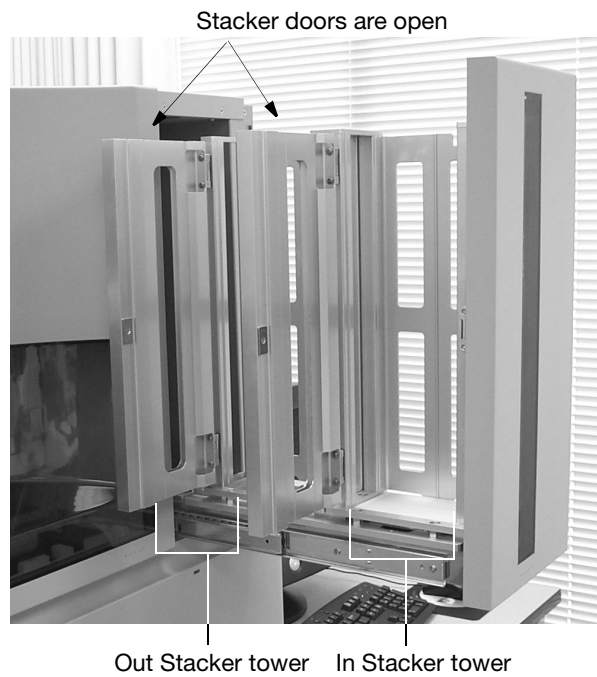

Figure 1-23 Stacker Towers

- Close the metal In Stacker tower door.
- Close the Stacker drawer (stacker light does not flash).

Running the Instrument

Scheduling Runs

Accessing the Run Schedule

To view the run schedule, click the **Run Scheduler** icon.

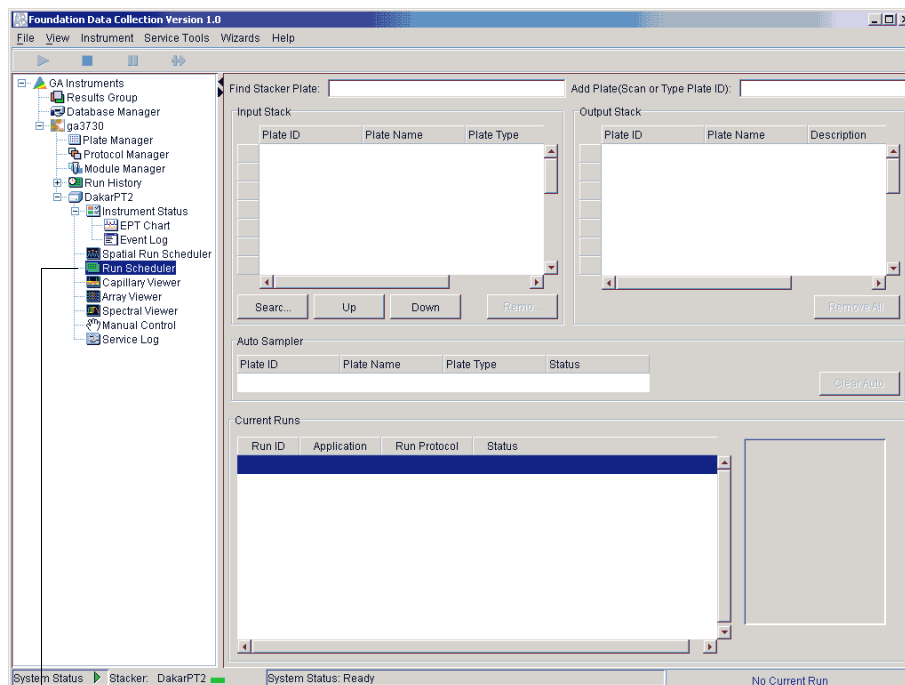
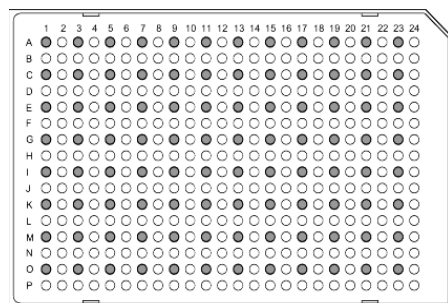

Figure 1-24 Click the Run Scheduler Icon

Default Run Scheduling

Samples within a plate run in the order of their well designation. For example, a default 384-well injection pattern looks like this:



- Quadrant 1: wells A1, C1, E1, G1...
- Quadrant 2: wells B1, D1, F1, H1...
- Quadrant 3: wells A2, C2, E2, G2...
- Quadrant 4: wells B2, D2, F2, H2...

Figure 1-25 Example of a 384-well injection pattern

- Plates that contain samples in a single quadrant and with more than one instrument protocol specified, run all the protocols in the order they appear in the plate record before the next quadrant is run.

Note: The analysis module of a sample plays no part in the order in which that sample quadrant runs.

For information on setting up a Plate record, see 2-37 for sequencing, and 3-29 for fragment analysis.

Default Load Maps

Default Load Maps

Refer to the following load maps for different size arrays and sample plates.

96-Well Plate, 48 Capillaries

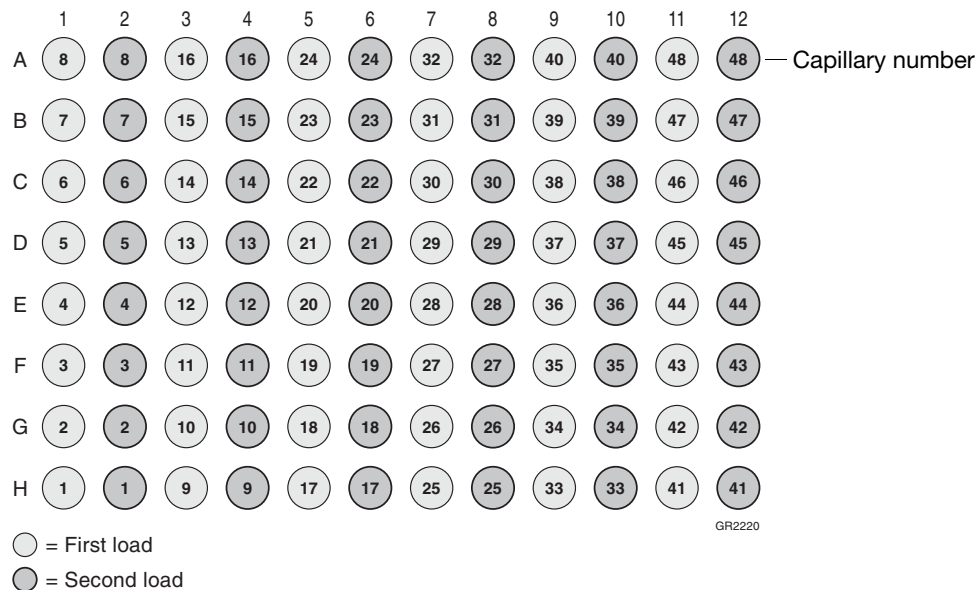

Figure 1-26 Sample Plate: 96-well, Array: 48-capillary

96-Well Plate, 96 Capillaries

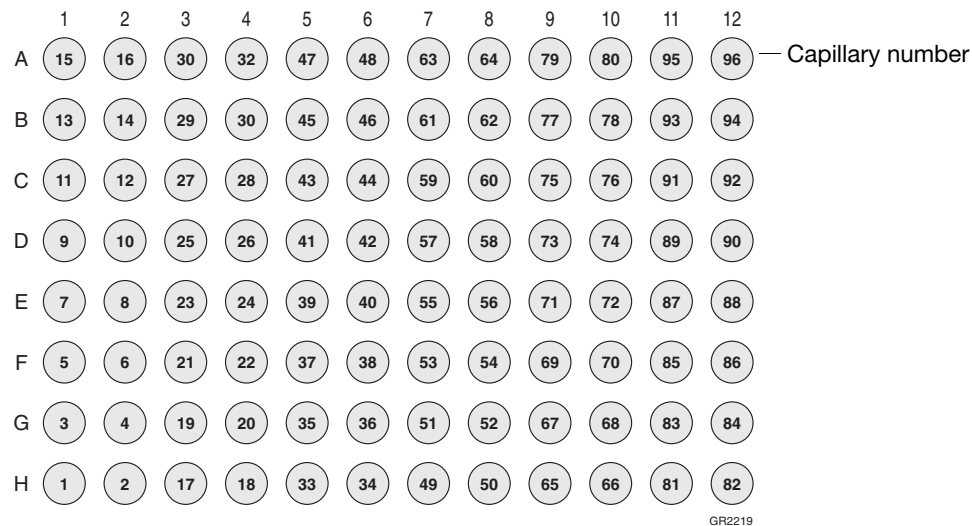

Figure 1-27 Array: 96-capillary, Sample Plate: 96-well

384-Well Plate, 48 Capillaries

First Quadrant Pickup

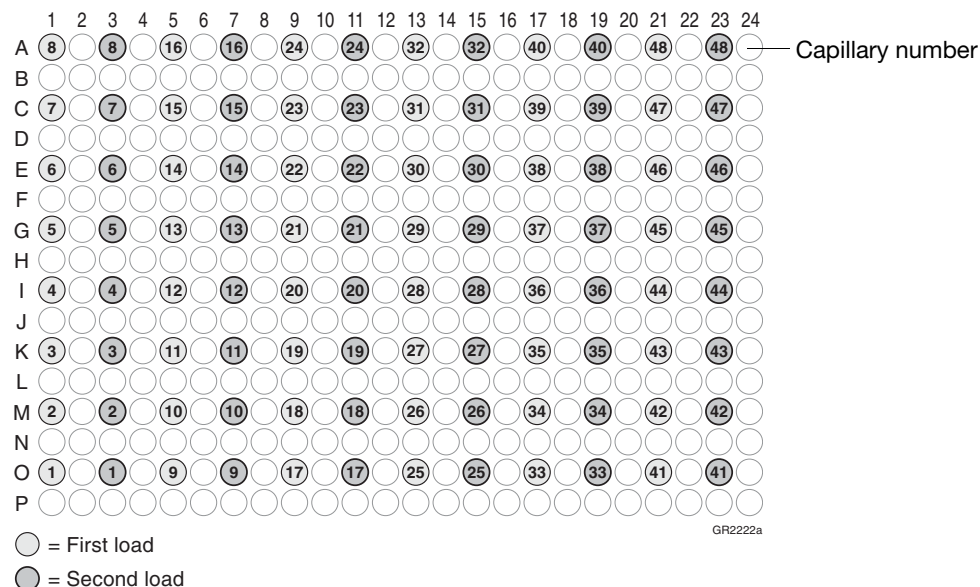

Figure 1-28 First Quadrant: 384-Well Plate, 48 Capillaries

Second Quadrant Pickup

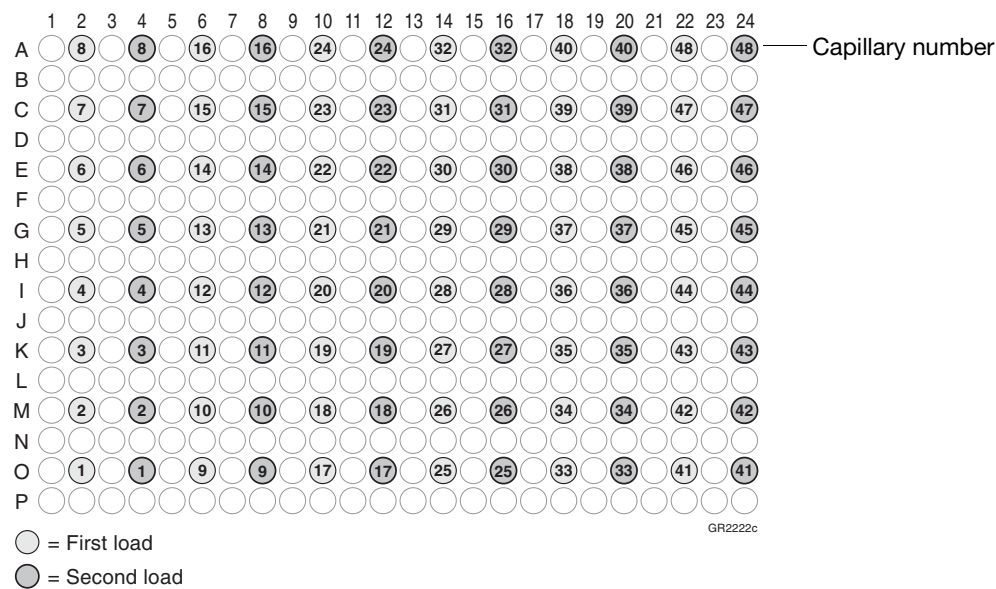

Figure 1-29 Second Quadrant: 384-Well Plate, 48 Capillaries

Third Quadrant Pickup

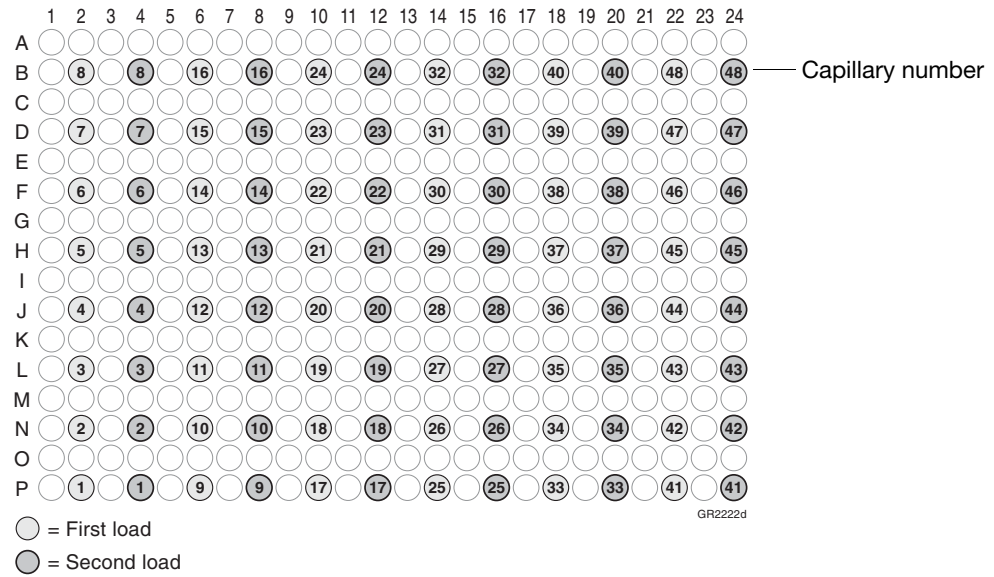

Figure 1-30 Third Quadrant: 384-Well Plate, 48 Capillaries

Fourth Quadrant Pickup

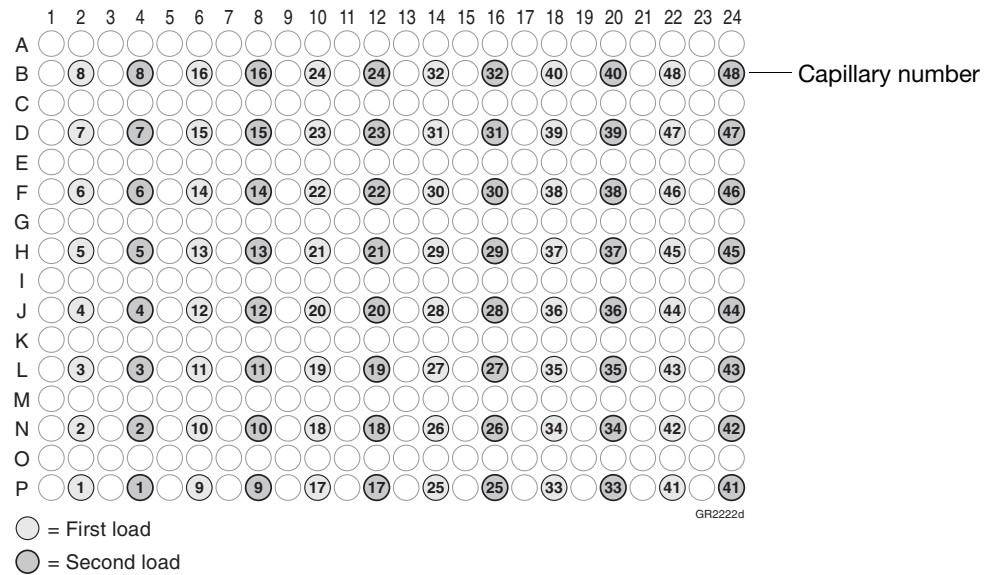

Figure 1-31 Fourth Quadrant: 384-Well Plate, 48 Capillaries

**384-Well Plate,
96 Capillaries**

First Quadrant Pickup

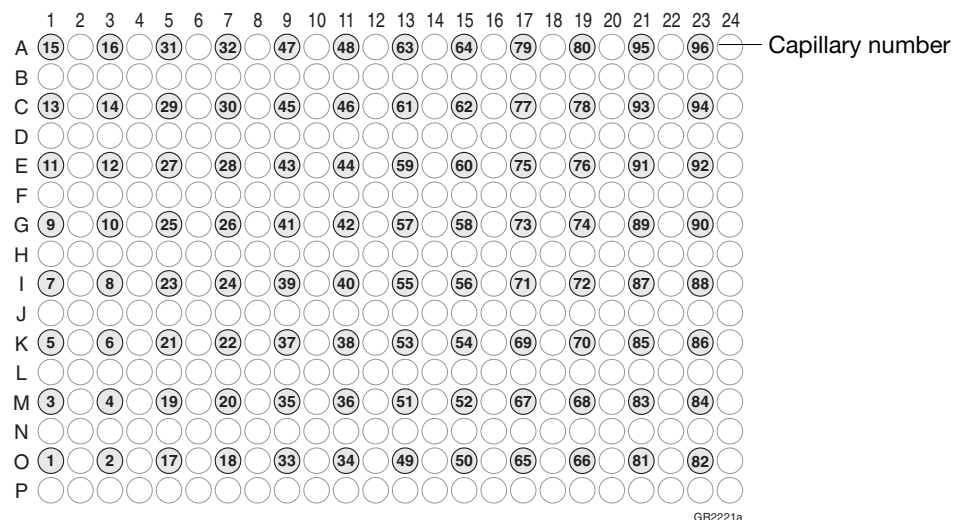

Figure 1-32 First Quadrant: 384-Well Plate, 96 Capillaries

Second Quadrant Pickup

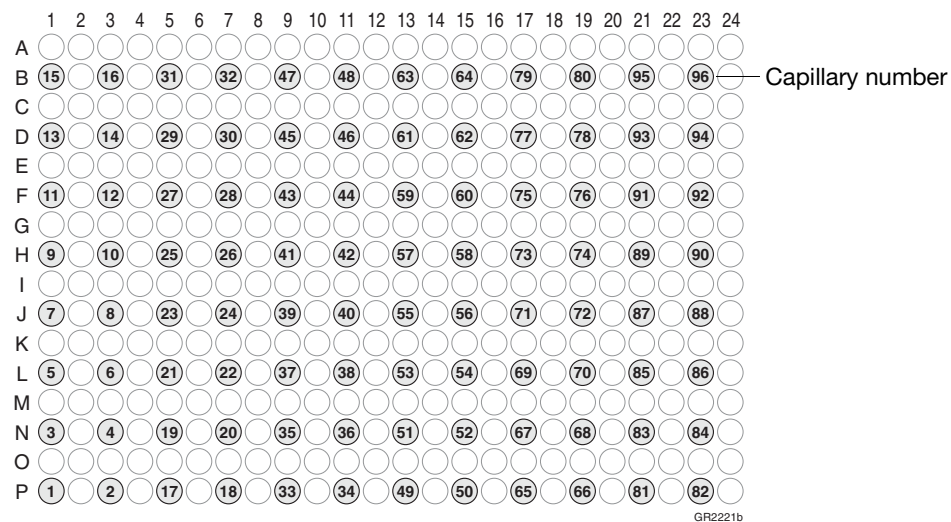

Figure 1-33 Second Quadrant: 384-Well Plate, 96 Capillaries

Third Quadrant Pickup

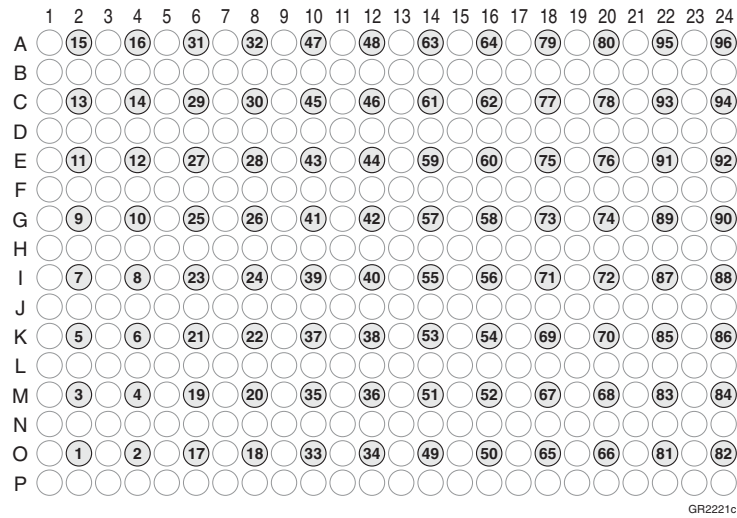

Figure 1-34 Third Quadrant: 384-Well Plate, 96 Capillaries

Fourth Quadrant Pickup

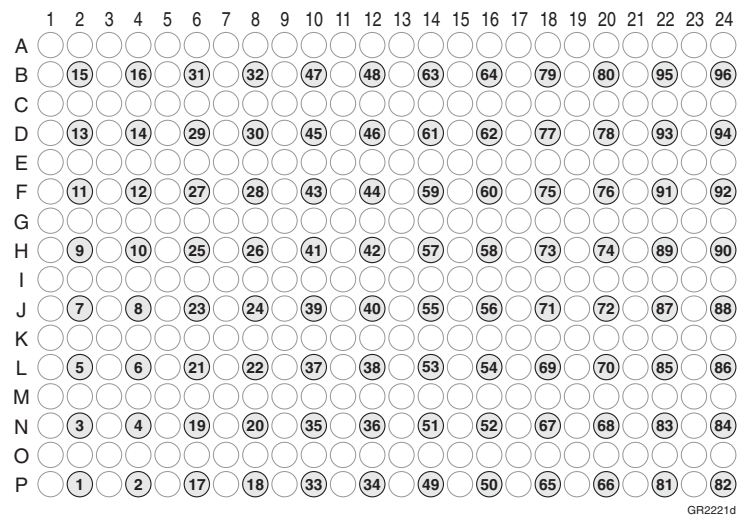

Figure 1-35 Fourth Quadrant: 384-Well Plate, 96 Capillaries

Default Run Priorities

The following table lists the default run priorities and load positions

Number of Capillaries	Plate Size	Run Priority	Quadrant	First Load Position
96	384-well	1	Q1	Well A1
		2	Q2	Well B1
		3	Q3	Well A2
		4	Q4	Well B2
48	96-well	1	Q1 , load 1	Well A1
			Q1 , load 2	Well A2
48	384-well	1	Q1 , load 1	Well A1
			Q1 , load 2	Well A3
		2	Q2 , load 1	Well B1
			Q2 , load 2	Well B3
		3	Q3 , load 1	Well A2
			Q3 , load 2	Well A4
		4	Q4 , load 1	Well B2
			Q4 , load 2	Well B4
<p>Note: When using a 48-capillary array, you can change the run order of the main quadrant (bold numbers above) but not the load numbers.</p>				

Globally Modifying a Run Schedule

You can change the run order of quadrants and then apply it to all 384-well plates.

To modify the run order for all 384-well plates:

1. Click your instrument name in the left pane.
2. Select **Instrument > Scheduling Preference**.

The Default 384 well scheduling preference dialog box displays.

3. Select the quadrant priority (run order) from the Quadrant list.

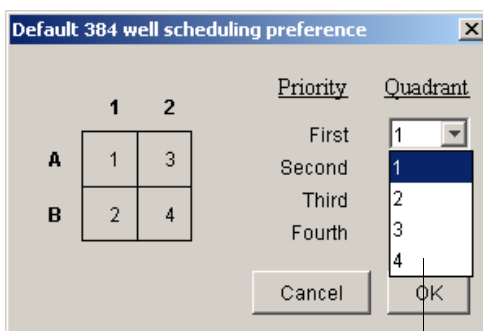
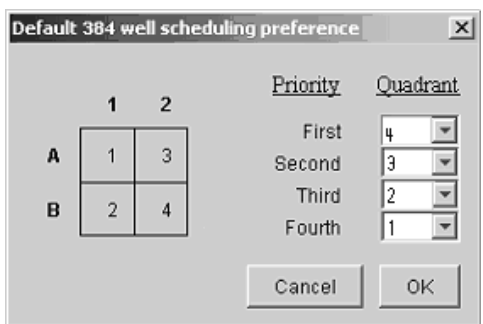

Figure 1-36 Quadrant Priority List

You may select any run order. The example below shows a 4-3-2-1 quadrant priority (run order).



In this example, the samples would run in this order:
B2, D2, F2...P2

Figure 1-37 Custom Priority

Locally Modifying a Run Schedule

You can also change the run order of quadrants within a specific sample plate.

To locally modify the run order within a single 384-well plate:

1. In the Plate Manager, click **New Plate**.

Note: For information about the Plate Manager, see page 2-37 for sequencing, and page 3-8 for fragment analysis.

2. Select **384-Well** from the Plate Type list.

The Scheduling box is activated.

3. Type the run priority in the Scheduling box.

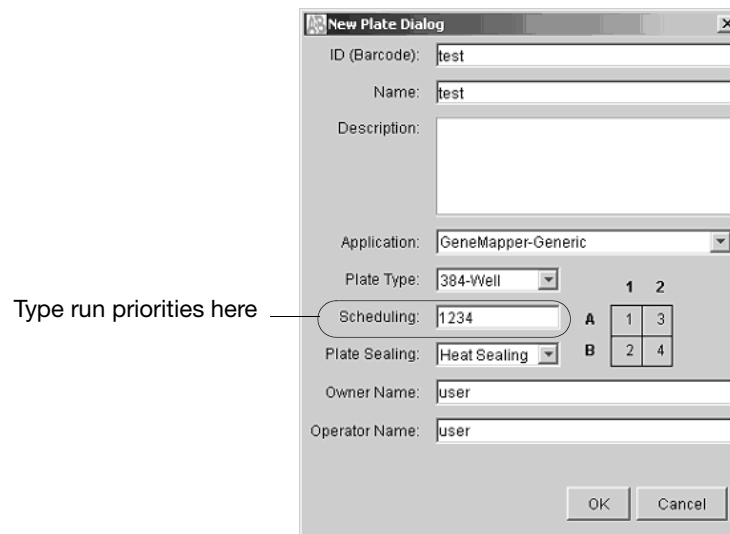

Figure 1-38 Scheduling in the New Plate Dialog box

4. Click **OK**.

Manual vs Auto Mode

Accessing Modes You may schedule a run or runs using either manual mode or auto mode. Both modes are described below. Access either mode by selecting:

Run Scheduler > Instrument > Instrument Name > Run mode (Auto or Manual)

Note: You must be in the Run Scheduler view to see the instrument run mode menu.



Manual Mode Features

The benefits and features of using manual mode are:

- Plates can be added to the stacker individually and in order.
- The internal barcode reader is not necessary to link plates to plate records in the local database.
- Plates do not need to have a barcode.

Scheduling Runs Using Manual Mode

To schedule runs using the manual mode (default):

1. Click the Run Scheduler icon.
2. Select **Instrument > Instrument Name > Manual mode**.
3. Click **Search** in the Run Scheduler to search for plate record(s).

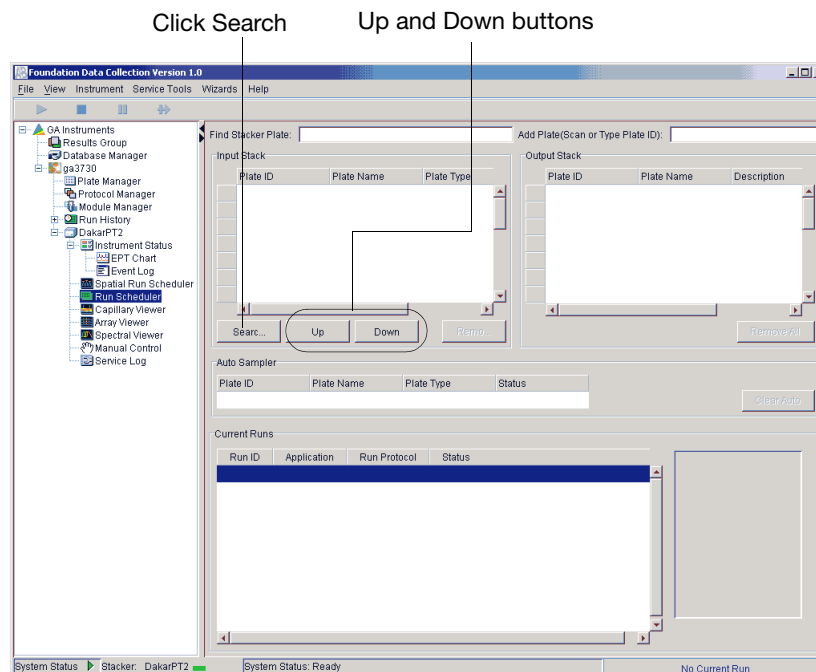

Figure 1-39 Run Scheduler

This opens the **Add Plates to In Stack** dialog box.

4. Type the name of the plate(s) or scan the plate ID and click **Search**.

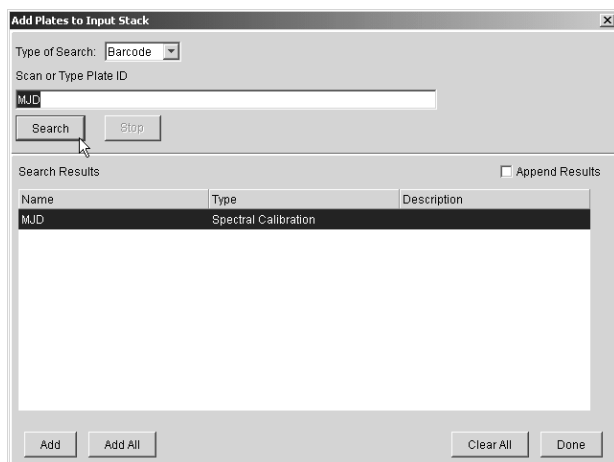

Figure 1-40 Barcode search

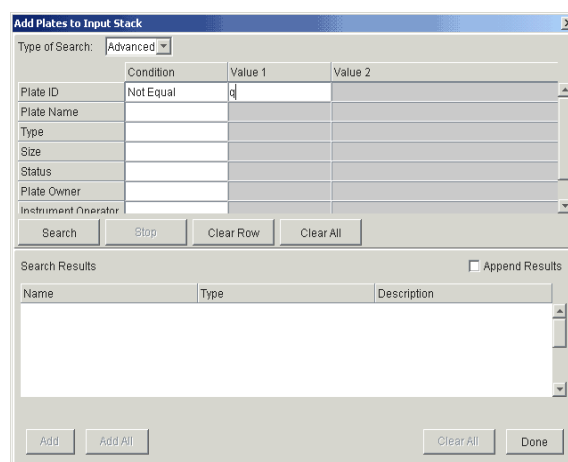

Figure 1-41 Advanced search

5. Select run(s) to add and then click **Add** to add the plate record(s) to the Input Stack in the order in which you want them to run.



6. Physically stack the plates in the In Stacker in order. The bottom plate runs first.

IMPORTANT! The order of the plate record must match the order the plates are stacked in the In Stacker. If the order does not match, processed runs will have the wrong plate record information.

Note: You may assign more plates in the Run Scheduler than are actually available in the stacker.

7. Click  (Run).

As the plates are retrieved by the autosampler, they are run in the order they were placed in the In Stack.

Auto Mode Features

The features and benefits of the using Auto Mode are:

- Plates must have barcodes.
- Internal barcode reader is necessary in order to link plates to plate records in the local database.
- You can add plates to the In Stack in any order.
- Plates can be added or removed during instrument operation.

To schedule runs using the Auto mode:

1. Select **Run Scheduler > Instrument Name > Auto mode**.

Search, Up, and Down buttons no longer an option in this window

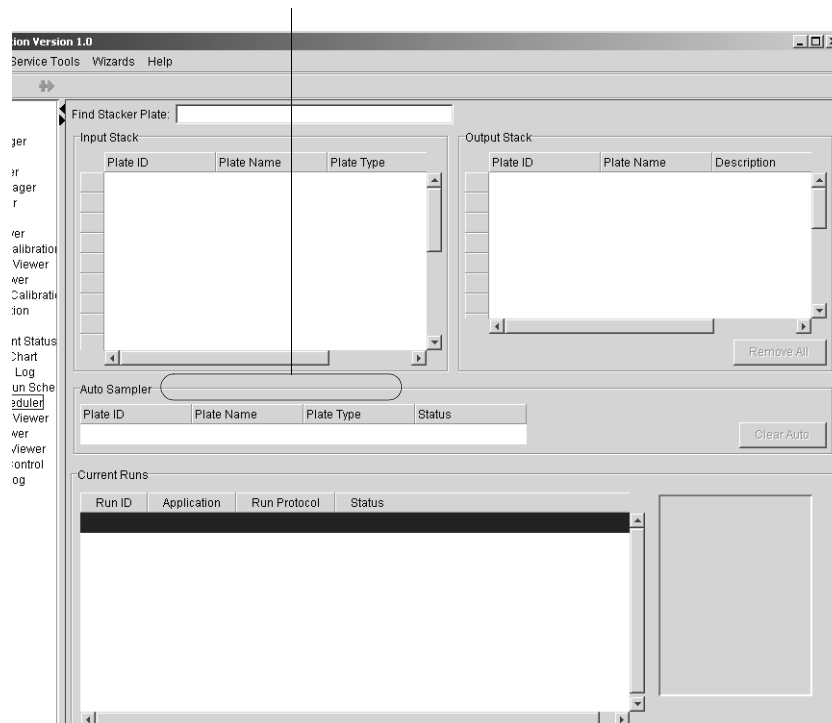



Figure 1-42 Auto Mode. Notice that the Search, Up, and Down buttons are no longer visible as they are in Manual mode. Also, you no longer have the Add Plate (Scan or Type Plate ID) option as you do in Manual mode.

2. Physically place plates in the In Stacker in any order. Remember that the bottom plate runs first, the top plate runs last.
3. Click  (Run).

As the plates are retrieved by the autosampler, plate barcodes are scanned and their plate records are associated with those stored in the local data collection database.





Controlling the Run

Controlling the Run Using the Toolbar

Use the toolbar at the top of the 3730/3730xl Data Collection software window to control the run.

Note: If the drives are full, see 5-31



To...	Click...
Start the run	
<ul style="list-style-type: none"> • Stop the current run and <ul style="list-style-type: none"> • Stop the other scheduled runs 	
<ul style="list-style-type: none"> • Complete the current run and <ul style="list-style-type: none"> • Stop the other scheduled runs 	
<ul style="list-style-type: none"> • Stop the current run and <ul style="list-style-type: none"> • Continue the other scheduled runs 	

Run Times

Basic Run Module Steps

When the run starts, the following basic steps are performed automatically by the instrument.

Module Steps
Turn on oven
Initialize autosampler
Fill syringe with polymer
Wait for oven to equilibrate (~30 min—for cold start only/first run).
Fill array (~2 min)
PreRun (~3 min)
Inject (~1 min)
Start separation/ramp voltage (10 min)
Collect data (variable)
Run ends: Leave oven on, laser to idle
Total time prior to separation: <ul style="list-style-type: none"> • Cold start: ~38 minutes • Warm start ~8 minutes (oven is already at temperature)

Note: A PostBatch Utility, which runs automatically, turns off the oven and the laser at the end of a batch of runs.

Approximate Run Times

The following table lists approximate run times:

Type of Analysis	Run Module	Run Time (when oven is heated)
Long read DNA sequencing	LongSeq50_POP7	2 hours
Standard read DNA sequencing	StdSeq36_POP7	1 hour
Rapid read DNA sequencing	RapidSeq36_POP7	35 minutes
Fragment analysis	GeneMapper36_POP7	35 minutes

Customizing Run Modules

You can modify default run modules to suit your particular needs.

To customize a default run module:

1. Click  (Module Manager).
2. Click **New**.

The Run Module Editor window displays.

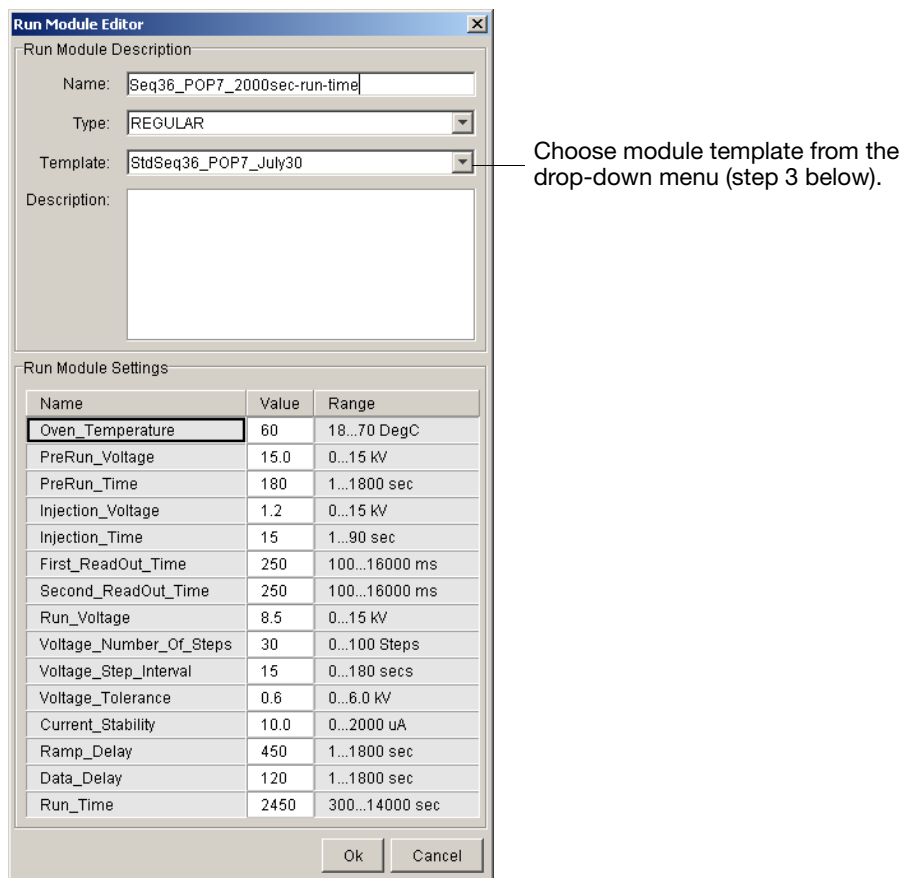

Figure 1-43 Customize Run Module Parameters

3. Select a template module as a basis for the new module.
4. Change to the desired module parameters using the table below as a guide to the allowable parameters.

Note: You cannot edit a default module installed with 3730/3730xl Data Collection.

Table 1-1 Editable Run Module Parameters

Name	Range	Comment
Oven_Temperature	18-70 C	Temperature setting for main oven throughout run.
PreRun_Voltage	0-15 kV	Pre run voltage setting before sample injection.
PreRun Time	1-1800 sec	Prerun voltage time.
Injection_Voltage	0-15 kV	Injection voltage setting for sample injection.
Injection_Time	1-90 sec	Sample injection time.
First_ReadOut_time	100-16000 millisecc	The interval of time for a data point to be produced. First_ReadOut_time should be equal to Second_ReadOut_time.
Second_ReadOut_Time	100-16000 millisecc	The interval of time for a data point to be produced. Second_ReadOut_time should be equal to First_ReadOut_time.
Run_Voltage	0-15 kV	Final run voltage.
Voltage_Number_Of_Steps	0-100 steps	Number of voltage ramp steps to reach Run_Voltage. We recommend that you do not change this value unless advised otherwise by Applied Biosystems support personnel.
Voltage_Step_Interval	0-180 sec	Dwell time at each voltage ramp step. We recommend that you do not change this value unless advised otherwise by Applied Biosystems support personnel.
Voltage_Tolerance	0.1-6 kV	Maximum allowed voltage variation. We recommend that you do not change this value unless advised otherwise by Applied Biosystems support personnel. If it goes beyond tolerance and shuts off, contact Applied Biosystems tech support.
Current_Stability	0-2000 microA	Maximum allowed electrophoresis current variation. Current fluctuations above this value will be attributed to air bubbles in system and the voltage automatically turned off. We recommend that you do not change this value unless advised otherwise by Applied Biosystems support personnel.
Ramp_Delay	1-1800 sec	Delay During Voltage Ramp. We recommend that you do not change this value unless advised otherwise by Applied Biosystems support personnel.
Data_Delay	1-1800 sec	Time from the start of separation to the start of data collection.
Run_Time	300-14000 sec	Duration data is collected after Ramp_Delay.

Monitoring a Run

Run Scheduler

Run Scheduler Window Click  (Run Scheduler) to monitor the status of the scheduled runs.

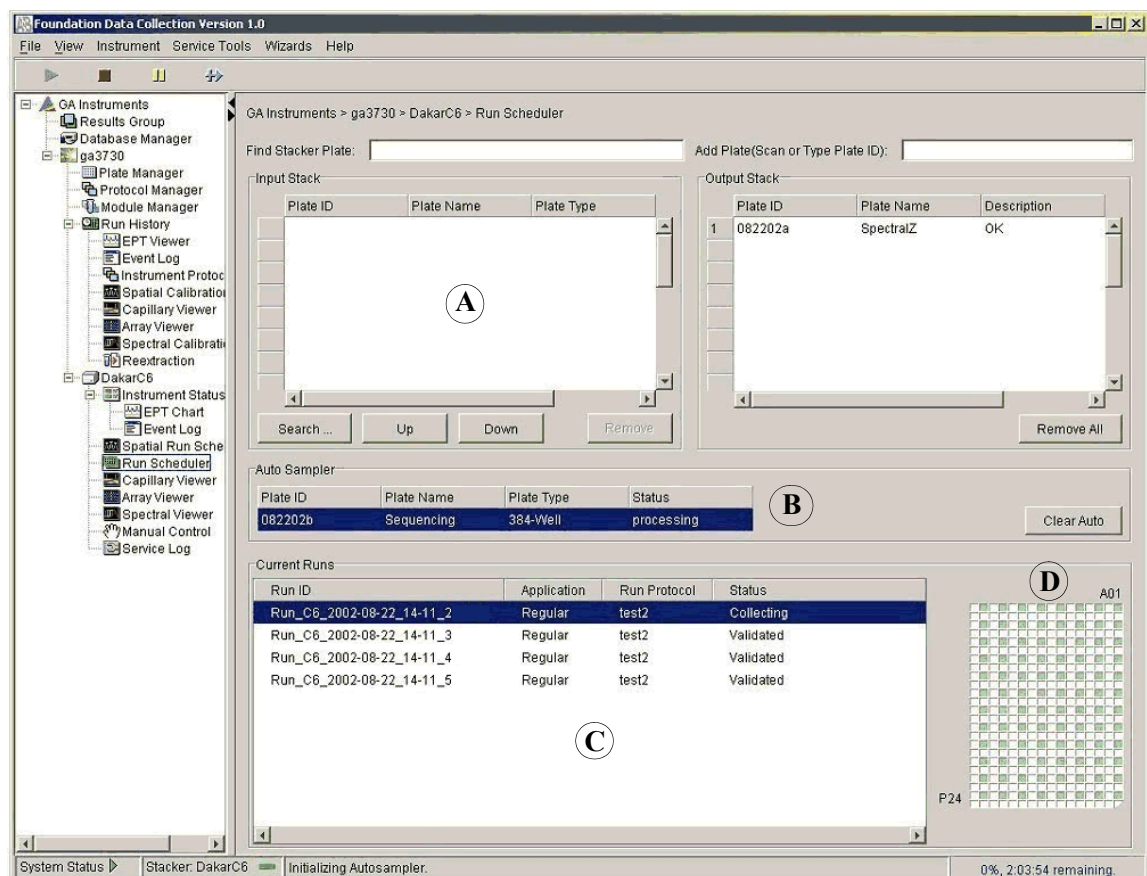

Figure 1-44 Run Scheduler Window

Run Scheduler Viewer Components

The following lettered descriptions correspond to the lettered sections on the graphic above.

- A) Each row in the In Stack pane provides information about pending runs.
- B) Clicking on the plate ID in the autosampler shows the pending runs for that plate.
- C) A run can be selected by single-clicking on a row in the Current Runs viewer.
- D) Each cell in the plate map grid on the lower right represents a capillary. The cells in the grid are green if the well position has a sample in it, and white if it does not for that selected run.

Note: For default load maps see page 1-28.

Instrument Status

Click  (Instrument Status) to monitor the status of the instrument or the current run.

Note: To monitor a spectral calibration run in real time, capillary by capillary, open the Event Log. For more Event Log information, see page 1-47.

Open the Event Log to monitor system messages

System Status must be 'Ready' before a run starts

Array Usage shows you how many times the array has been used

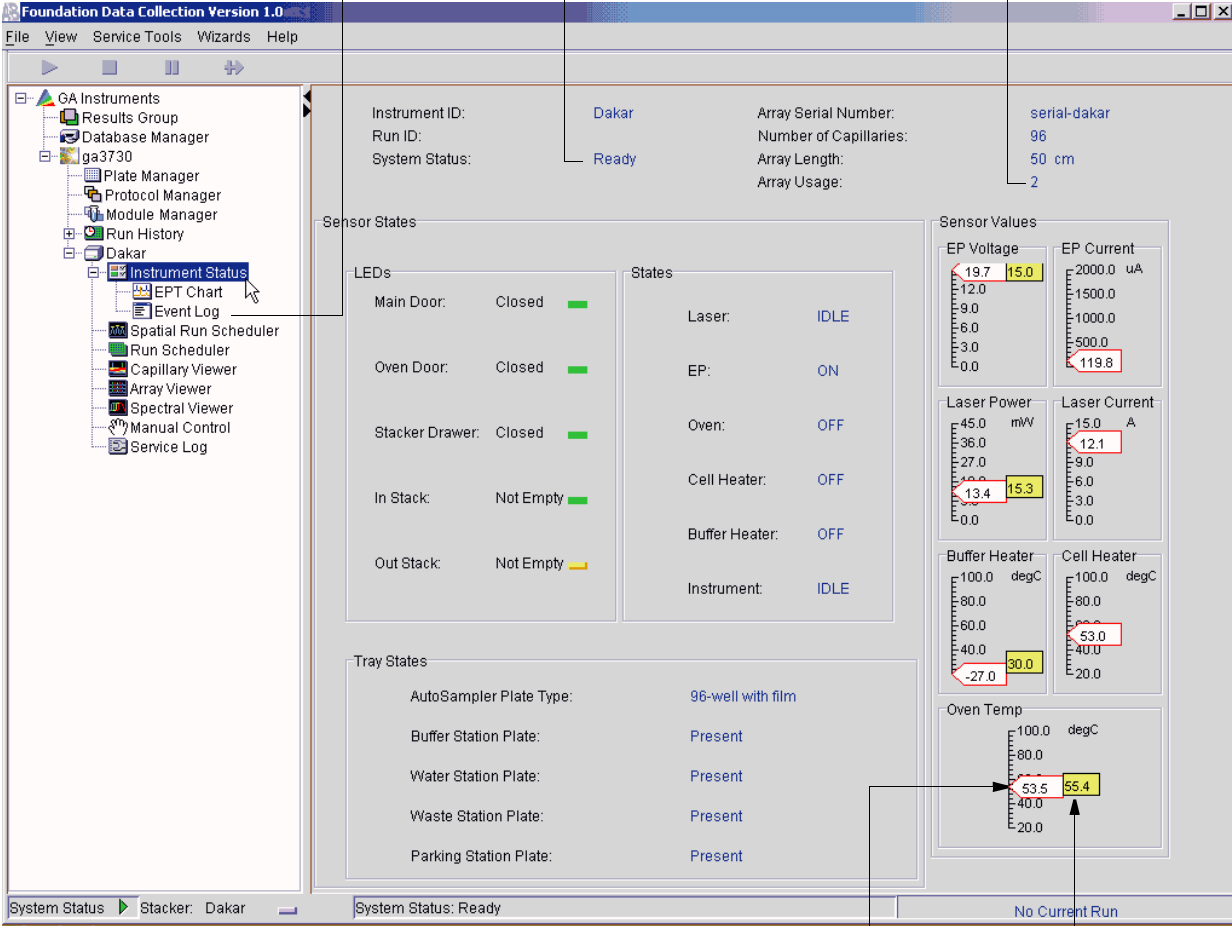

System Information	
Instrument ID:	Dakar
Run ID:	96
System Status:	Ready
Array Serial Number:	serial-dakar
Number of Capillaries:	96
Array Length:	50 cm
Array Usage:	2

Sensor States	
LEDs	
Main Door:	Closed ■
Oven Door:	Closed ■
Stacker Drawer:	Closed ■
In Stack:	Not Empty ■
Out Stack:	Not Empty ■
States	
Laser:	IDLE
EP:	ON
Oven:	OFF
Cell Heater:	OFF
Buffer Heater:	OFF
Instrument:	IDLE

Sensor Values	
EP Voltage	EP Current
19.7 15.0	2000.0 uA
12.0	1500.0
9.0	1000.0
6.0	500.0
3.0	119.8
0.0	
Laser Power	Laser Current
45.0 mW	15.0 A
36.0	12.1
27.0	9.0
13.4 15.3	6.0
0.0	3.0
	0.0
Buffer Heater	Cell Heater
100.0 degC	100.0 degC
80.0	80.0
60.0	53.0
40.0	40.0
-27.0	20.0
Oven Temp	
100.0 degC	
80.0	
60.0	
40.0	
53.5	55.4
20.0	

Tray States	
AutoSampler Plate Type:	96-well with film
Buffer Station Plate:	Present
Water Station Plate:	Present
Waste Station Plate:	Present
Parking Station Plate:	Present

System Status: Stacker: Dakar | System Status: Ready | No Current Run

Figure 1-45 Instrument Status Window

Actual measured value

Set value (defined in the selected run module)

Sensor States Pane The simulated LEDs in this pane provide a quick way to check the instrument status. The table below lists the instrument component and what the LED color indicates. Generally, a red light indicates an “out of normal” operating condition and you should therefore pay attention to the specific item.

For...	A green light indicates...	A red light indicates...	A yellow light indicates...
Main Door	the door is closed	the door is open	—
Oven Door	the oven door is closed	the oven door is open	—
Stacker Drawer	the stacker drawer is closed	the stacker drawer is open	—
In Stack	at least one plate with an unknown barcode number is in the In stack	no plates are present in the In stack	—
Out Stack	empty, no plates are in the Out stack	full, you need to remove plates before further processing	not empty

The States pane indicates the status of the:

- Laser (on/off/idle)
- Electrophoresis (on/off)
- Oven (on/off)
- Cell Heater (on/off)
- Buffer Heater (on/off)
- Instrument (idle, pause, initialize, running, fail)

Tray States Pane The Tray States pane indicates the status of all system trays as well as the plate type:

- Buffer Station Plate (present/empty)
- Water Station Plate (present/empty)
- Waste Station Plate (present/empty)
- Parking Station Plate (present/empty)
- Autosampler Plate Type:
 - 96-well septa
 - 384-well septa
 - 384-well with film
 - 96-well with film
 - buffer, water, waste, empty, unknown

EPT Chart The EPT Viewer displays real-time electrophoresis (EP) data during a run.

To activate the EPT Viewer:

1. Click  (Instrument Status) to expand it.

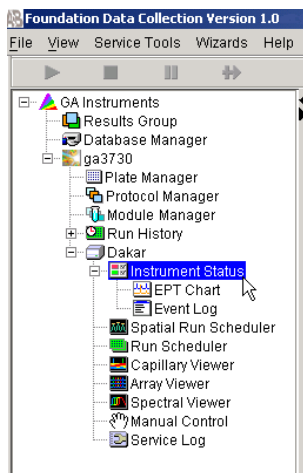

Figure 1-46 Left Pane Tree

2. Click  (EPT Chart).

The EPT chart displays.

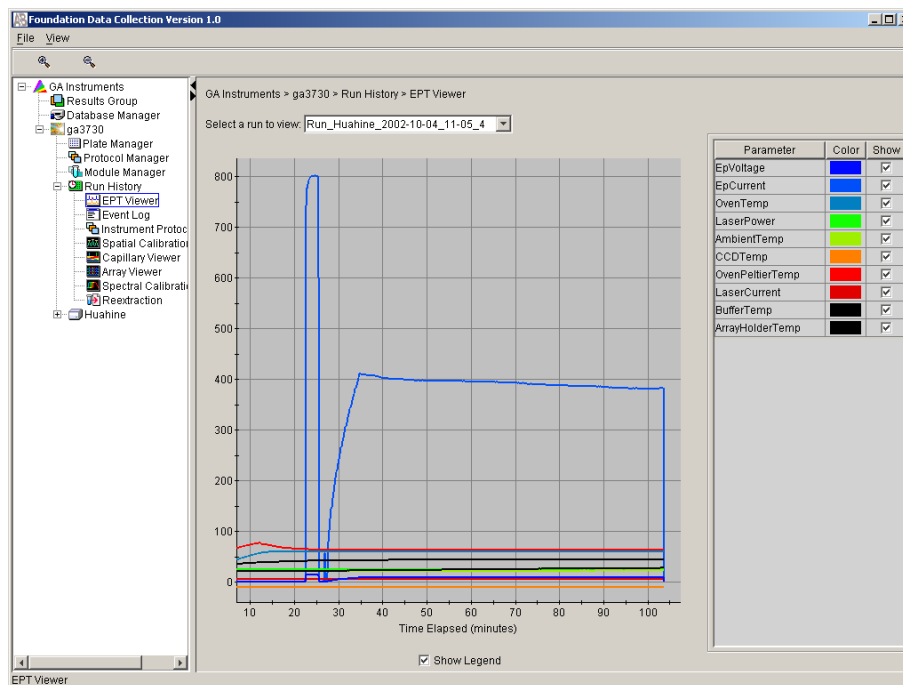

Figure 1-47 EPT Chart

Event Log The Event log graphically itemizes events such as errors and general information, as the graphic below illustrates.

Clear error messages by clicking **Clear Errors**. The System Status light flashes red until all errors are cleared.

Note: This view can also be used to monitor a spectral calibration run in real time to verify the capillary-by-capillary processing status.

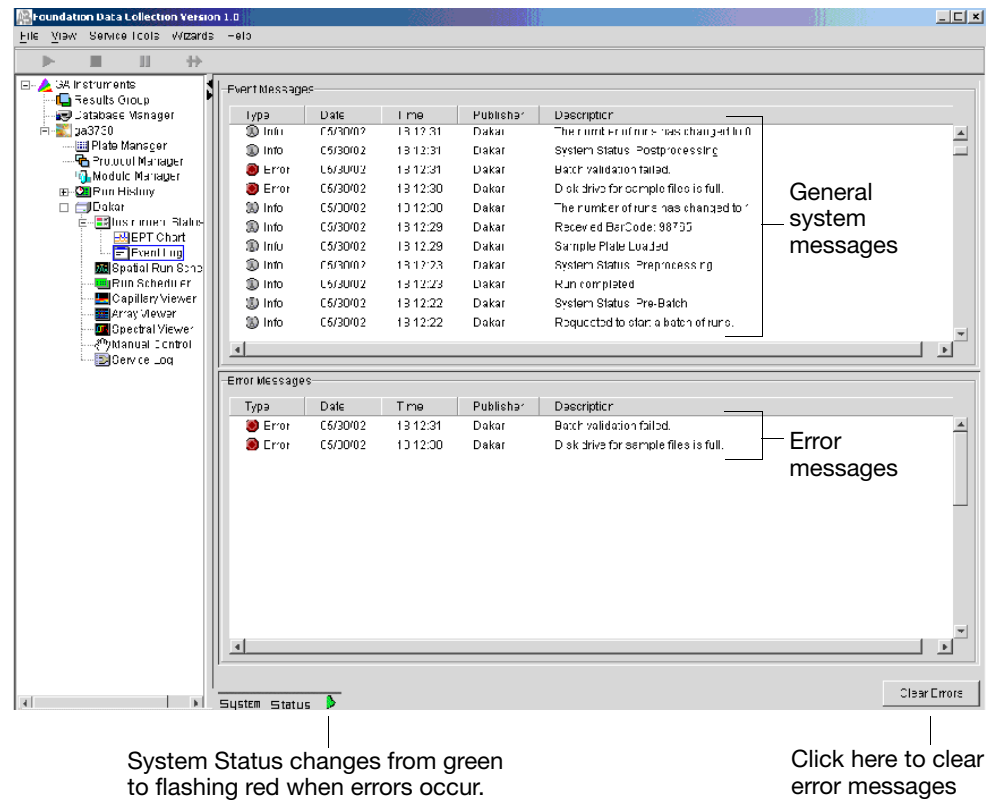



Figure 1-48 Elements of the Event Log Window

Array Viewer

Overview There are two formats for viewing data within the Applied Biosystems 3730/3730xl DNA Analyzer Data Collection Software under the Run History icon:

- In the Array Viewer window
- In the Capillary Viewer window, capillary-by-capillary

Viewing Data in the Array Viewer Click  (Array Viewer) during or after a run to examine the quality of your data, which is displayed as color data for the entire capillary array. You can view all the capillaries (vertical axis) as a function of time/data point (horizontal axis).

The graphic below is an example of the Array Viewer window.

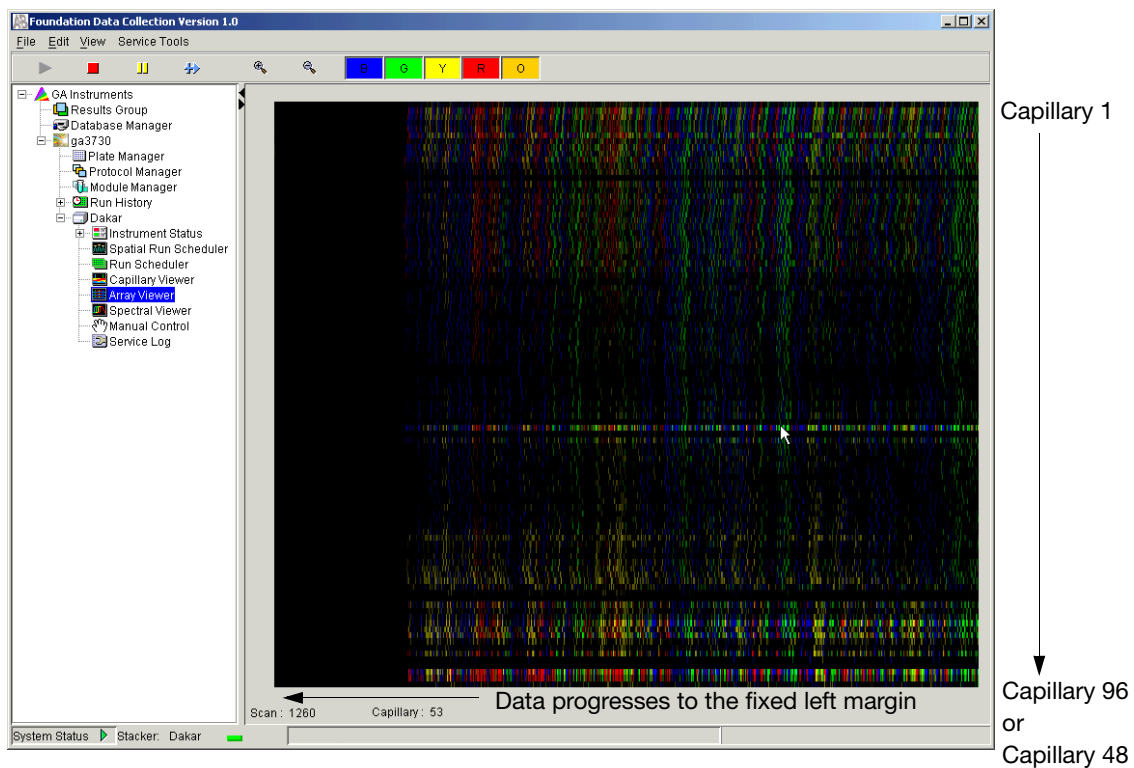



Figure 1-49 Array Viewer Window

How to Zoom To zoom:

1. Hold and drag the mouse over the area of interest.
2. Release the mouse and click  to expand the view.
3. Click  to return to full view.

Color Bar Click individual colors to view or hide them (same in Capillary Viewer).



Capillary Viewer

Overview There are two formats for viewing data within the Applied Biosystems 3730/3730xl DNA Analyzer Data Collection Software under the Run History icon:

- In the Array Viewer window
- In the Capillary Viewer window, capillary-by-capillary

Viewing Data Click  (Capillary Viewer) to examine the quality of electropherogram data for individual capillaries.

The graphic below is an example of the Capillary Viewer window.

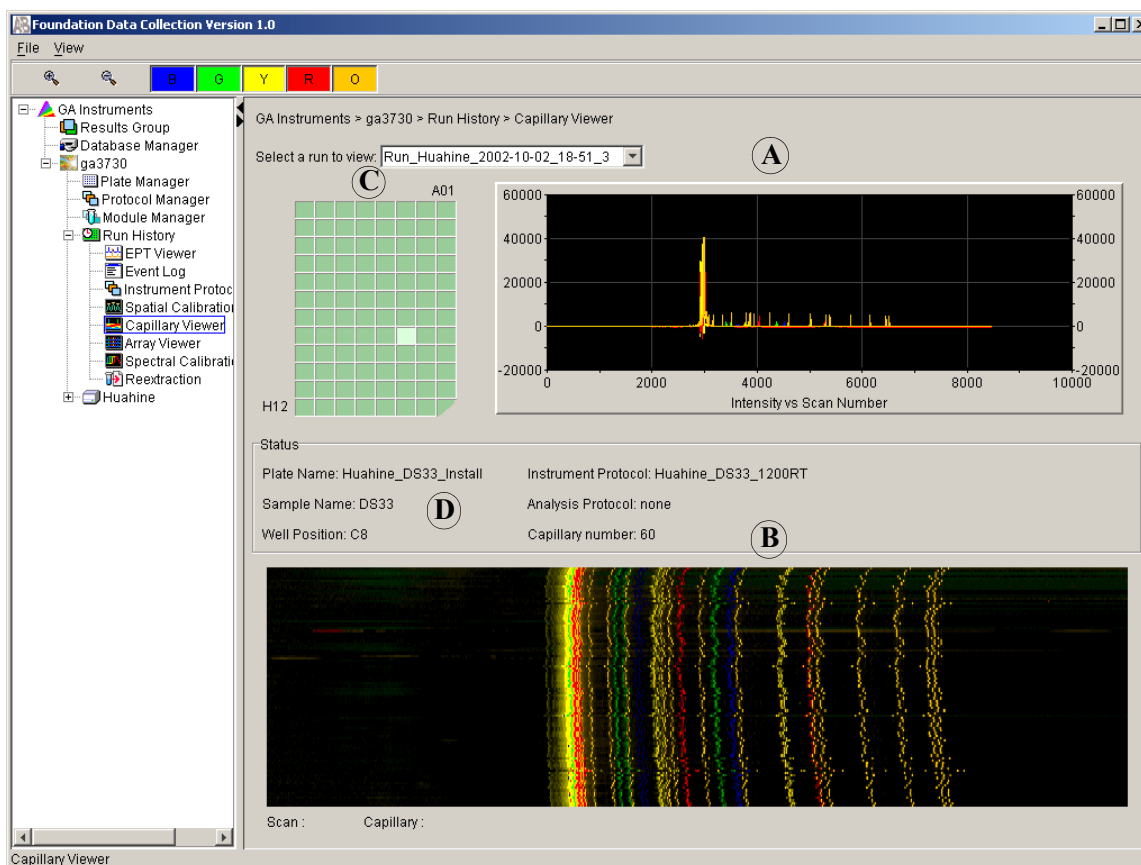



Figure 1-50 Capillary Viewer Window

Capillary Viewer Window Components

- A) The upper plot represents the expanded portion of the color data being collected in real time, in 200 scan intervals.
- B) The lower plot represents the entire data trace collected thus far.
- C) Click a cell in the plate map grid to view data from that particular capillary.
- D) More details of a particular sample can be viewed in the Status table.

Note: For default load maps see page 1-28.

How to Zoom To zoom:

1. Hold and drag the mouse over the area of interest.
2. Release the mouse and click  to expand the view.
3. Click  to return to full view.

Electropherogram Displays

An electropherogram is a graph of relative dye concentration against time, plotted for each dye. The data displayed is multicomponented (that is, corrected for spectral overlap). The relative dye concentration is determined by applying chemometric algorithms to the collected fluorescence data.

Array View in the Capillary Viewer

The Capillary and Array views can be alternately viewed in the same window by toggling between Show capillary view and Show array view.

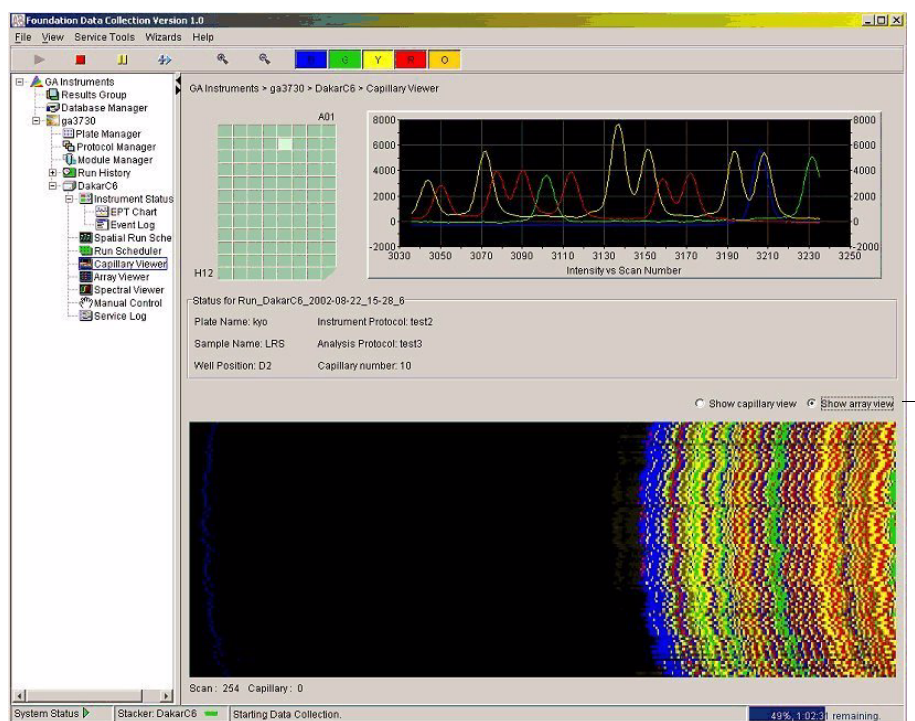

Figure 1-51 Toggle between Array and Capillary views







Working with Data in The Run History View

Run History Components

Elements of the Run History Utility

The Run History utility can be used only with completed runs stored in the local 3730/3730xl Data Collection database. It does not provide real-time viewing of collecting runs.

In the left tree pane, click the icon next to the function to launch it.

Elements Within the Run History Utility	Icon
EPT Viewer Note: If Cleanup Database has been used, you cannot view processed data in Run History.	
Spatial Calibration Viewer	
Capillary Viewer Note: If Cleanup Database has been used, you cannot view processed data in Run History.	
Array Viewer Note: If Cleanup Database has been used, you cannot view processed data in Run History.	
Spectral Calibration Viewer	
Reextraction Note: If Cleanup Database has been used, you cannot view processed data in Run History.	

Viewing Data from a Completed Run in the Data Collection Software

Overview There are two formats for viewing data within the Applied Biosystems 3730/3730xl DNA Analyzer Data Collection Software under the Run History icon:

- In the Array Viewer window (in much the same way that you might view the gel file output from an ABI PRISM® slab gel instrument).
- In the Capillary Viewer window, capillary-by-capillary.

Viewing Data To view data from a completed run:

1. On the left tree pane in the 3730/3730xl Data Collection software, click  (Run History) to select the run you want to view.

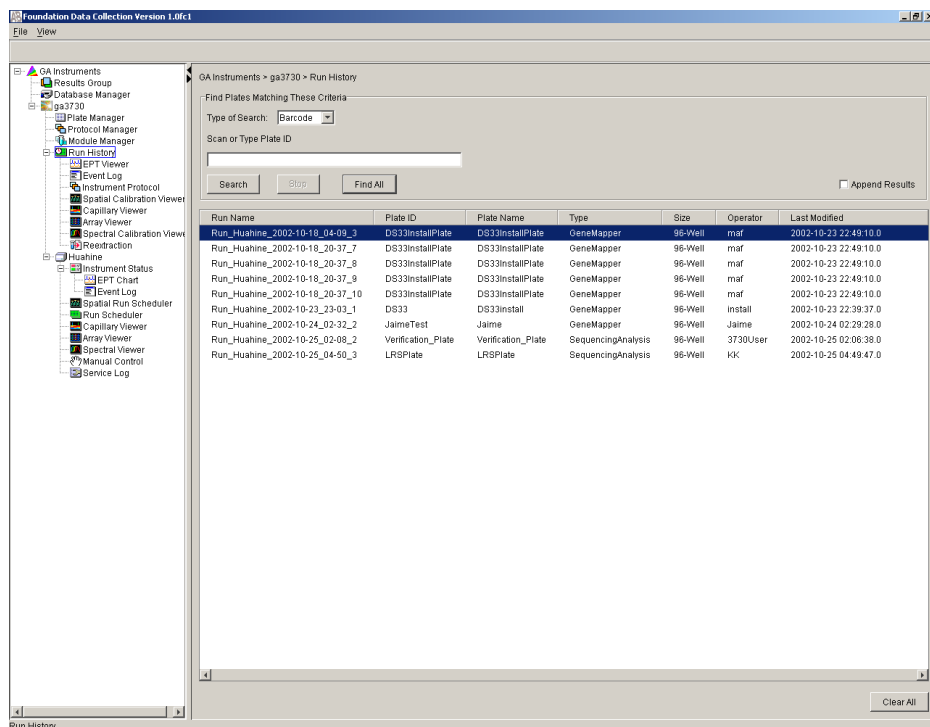



Figure 1-52 Viewing Data

2. Search for your run by either Barcode or Advanced search.

Note: For information on plate search for sequencing, see page 2-37, and page 3-35 for fragment analysis.

3. After choosing the run, click the Array Viewer or the Capillary Viewer from the left tree pane.

Viewing the Results of Autoextraction

Overview	<p>After a run is completed, extraction and analysis is performed automatically, according to the settings in the Plate Editor (sequencing see page 2-8, fragment analysis see page 3-11) and the Results Group (sequencing see page 2-37, fragment analysis see page 3-29). The results of extraction and analysis can be viewed in the Reextraction Panel. Samples can be extracted again with the same settings, or with different Analysis Protocols or different Results Groups. This can be useful for many reasons:</p> <ul style="list-style-type: none"> • The destination location may not have been available during extraction. • Some samples may have failed analysis and a different Analysis Protocol might be more successful. • Samples might be saved in different locations, or with no analysis at all to save space.
Sample File Destinations	<p>Locations where sample files are placed during extraction:</p> <ul style="list-style-type: none"> • Default Destination, and default folder naming: Data / instrument type / instrument name / run folder (No ProcessedData folder) • Default Destination, custom folder naming: Data/top custom folder/subfolders, etc. • Custom Destination, default folder naming: Destination/instrument type/instrument name/run folder • Custom Destination, custom folder naming: Destination/top custom folder/subfolders, etc.
Runs Stopped Before Complete Autoextraction	<p>Runs that are stopped before completion display the status “Completed” in the Run Scheduler and the plate is moved to the Out Stack. In the Instrument View the status is changed to “Ready.” Successfully extracted and analyzed runs display the status processed in the same Run View page.</p> <p>The auto extractor component of the 3730/3730xl Data Collection automatically extracts data from stopped runs. If autoextraction fails, click the Reextraction icon  to extract data.</p>
Effects of Changes Made in the Reextraction Panel	<p>Changes made in the Reextraction Panel to a Results Group, Analysis protocol, Comments, etc., also change in the original plate record. The original plate information is overwritten.</p>

Selecting and Queuing Samples for Extraction

You can queue individual samples for reextraction. This is especially useful for experimenting with different Analysis Protocols for samples that have failed initial extraction.

To select and queue samples for extraction:

1. Click  (Run History).
2. Enter the plate ID for a plate that has been completed, or click **Search**. Plates that have runs still pending cannot be reextracted. All the runs from that plate appear in the window.

Note: To use the Advanced search option, see page 2-38 for sequencing or page 3-36 for fragment analysis.

3. Select a run from the list.

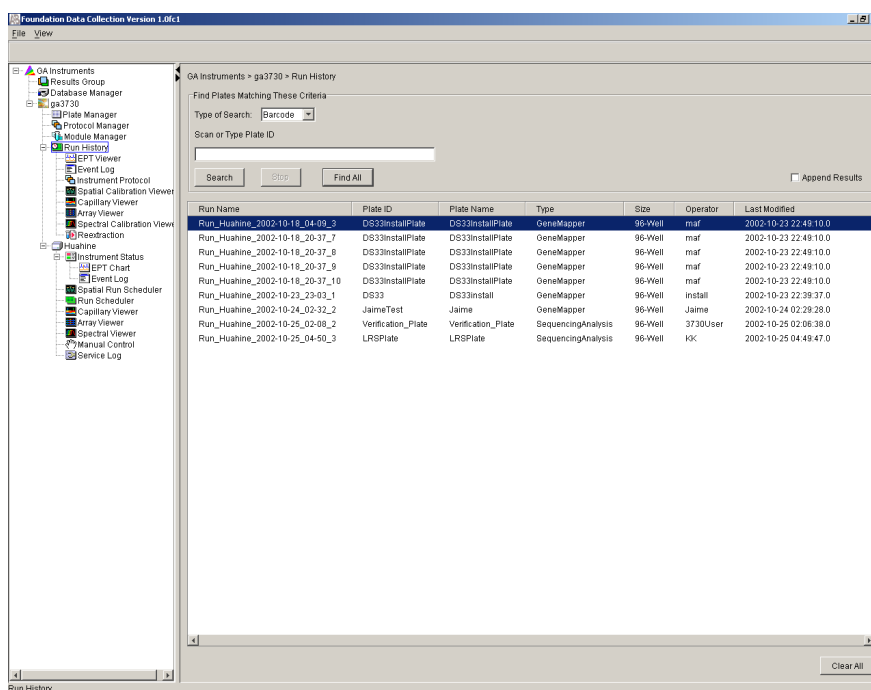



Figure 1-53 Run History Search Results

4. Click  (Reextraction) in the left tree pane.
The Reextraction window displays
5. Click the checkboxes in the Extract column to select the samples to be reextracted.
6. Click **Extract** to start the reextraction.

Note: Reextracted sample files are saved in the original folder that data was extracted to.

Elements of the Reextraction Window

All the samples are displayed with the results of extraction and analysis.

Note: Sort the columns of the re-extraction panel by holding the shift key and then clicking on a column header.

Use check boxes to select samples to be reextracted

Capillary number

Well position

Results of extraction and analysis

Fields can be edited for reextraction

Click here to start extraction

These are used if several samples are highlighted

Extract	Cap	Well	Result	Quality	Sample Name	Comment	Results Group	Analysis Protocol
<input checked="" type="checkbox"/>	82	H12	SUCCESS: A	Yellow	seq3	sample comment	SPrimeNoSeq	SPrime
<input checked="" type="checkbox"/>	84	G12	SUCCESS: A	Yellow	seq3	sample comment	SPrimeNoSeq	SPrime
<input checked="" type="checkbox"/>	86	F12	SUCCESS: A	Yellow	seq3	sample comment	SPrimeNoSeq	SPrime
<input checked="" type="checkbox"/>	88	E12	SUCCESS: A	Yellow	seq3	sample comment	SPrimeNoSeq	SPrime
<input checked="" type="checkbox"/>	90	D12	SUCCESS: A	Yellow	seq3	sample comment	SPrimeNoSeq	SPrime
<input checked="" type="checkbox"/>	92	C12	SUCCESS: A	Yellow	seq3	sample comment	SPrimeNoSeq	SPrime
<input checked="" type="checkbox"/>	94	B12	SUCCESS: A	Yellow	seq3	sample comment	SPrimeNoSeq	SPrime
<input checked="" type="checkbox"/>	96	A12	SUCCESS: A	Red	seq3	sample comment	SPrimeNoSeq	SPrime
<input checked="" type="checkbox"/>	81	H11	SUCCESS: A	Yellow	seq3	sample comment	SPrimeNoSeq	SPrime
<input checked="" type="checkbox"/>	83	G11	SUCCESS: A	Yellow	seq3	sample comment	SPrimeNoSeq	SPrime
<input checked="" type="checkbox"/>	85	F11	SUCCESS: A	Yellow	seq3	sample comment	SPrimeNoSeq	SPrime
<input checked="" type="checkbox"/>	87	E11	SUCCESS: A	Yellow	seq3	sample comment	SPrimeNoSeq	SPrime
<input checked="" type="checkbox"/>	89	D11	SUCCESS: A	Yellow	seq3	sample comment	SPrimeNoSeq	SPrime
<input checked="" type="checkbox"/>	91	C11	SUCCESS: A	Yellow	seq3	sample comment	SPrimeNoSeq	SPrime
<input checked="" type="checkbox"/>	93	B11	SUCCESS: A	Yellow	seq3	sample comment	SPrimeNoSeq	SPrime
<input checked="" type="checkbox"/>	95	A11	SUCCESS: A	Yellow	seq3	sample comment	SPrimeNoSeq	SPrime
<input checked="" type="checkbox"/>	66	H10	SUCCESS: A	Yellow	seq3	sample comment	SPrimeNoSeq	SPrime
<input checked="" type="checkbox"/>	68	G10	SUCCESS: A	Yellow	seq3	sample comment	SPrimeNoSeq	SPrime
<input checked="" type="checkbox"/>	70	F10	SUCCESS: A	Yellow	seq3	sample comment	SPrimeNoSeq	SPrime
<input checked="" type="checkbox"/>	72	E10	SUCCESS: A	Yellow	seq3	sample comment	SPrimeNoSeq	SPrime
<input checked="" type="checkbox"/>	74	D10	SUCCESS: A	Yellow	seq3	sample comment	SPrimeNoSeq	SPrime
<input checked="" type="checkbox"/>	76	C10	SUCCESS: A	Red	seq3	sample comment	SPrimeNoSeq	SPrime
<input checked="" type="checkbox"/>	78	B10	SUCCESS: A	Yellow	seq3	sample comment	SPrimeNoSeq	SPrime
<input checked="" type="checkbox"/>	80	A10	SUCCESS: A	Yellow	seq3	sample comment	SPrimeNoSeq	SPrime
<input checked="" type="checkbox"/>	65	H9	SUCCESS: A	Yellow	seq3	sample comment	SPrimeNoSeq	SPrime
<input checked="" type="checkbox"/>	67	G9	SUCCESS: A	Yellow	seq3	sample comment	SPrimeNoSeq	SPrime
<input checked="" type="checkbox"/>	69	F9	SUCCESS: A	Yellow	seq3	sample comment	SPrimeNoSeq	SPrime

Figure 1-54 Elements of the Reextraction Window

Results Column The results of extraction and analysis are color coded in the Results column. The following table lists the colors and their values.

Color	Value	Notes
Red	Extraction or analysis failed	Descriptive messages can be viewed by resizing the Results column to view all text (click on the arrow)
Yellow *	Warnings for extraction or analysis	
Green	Successful extraction (with no analysis intended), or successful extraction and analysis.	

* Note: The text message for samples that produce yellow is: "FAILURE: Analysis Failed
Bad Data; Error Number=nnnnn
WARNING..."

The Results column, by default, shows only the beginning of any processing message. The entire message returned from extraction and autoanalysis is inside the cell and can be viewed by expanding the cell. The location of the stored sample is also found there. In addition, there is a tooltip view for each sample results message.

Tooltip view. Access by placing the cursor over the sample of interest

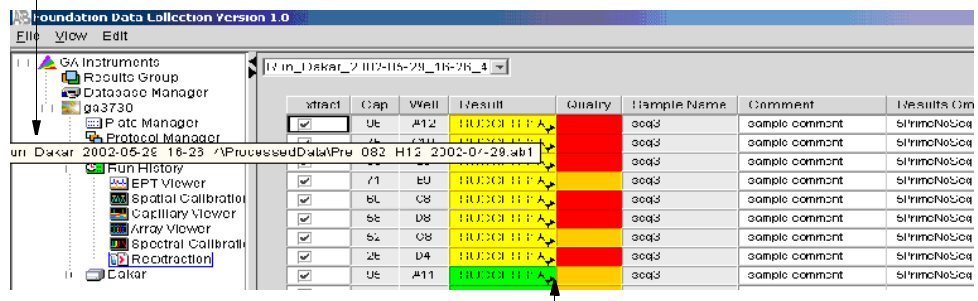

Figure 1-55 Drag the cell's edge to expand the column

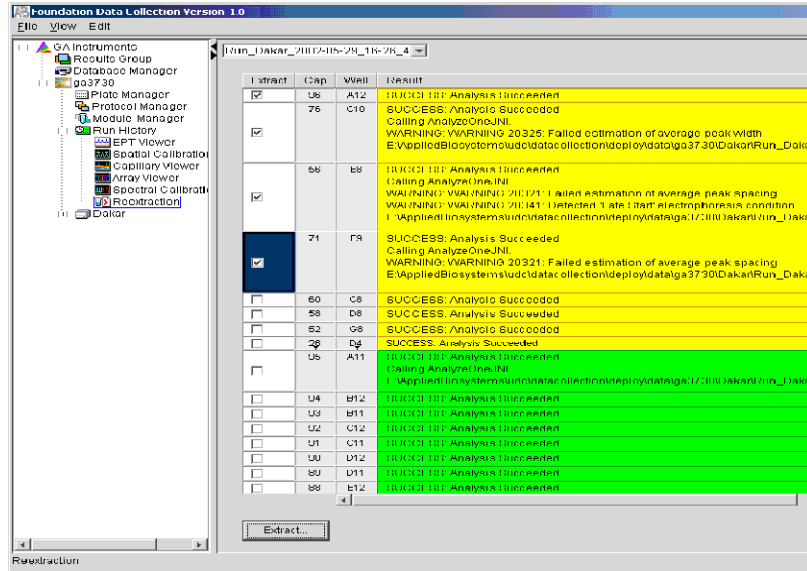

Figure 1-56 Expanded column

Quality Column The Quality column represents the quality values for an entire sequence. Quality Values are only assigned to analyzed samples when using the KB Basecaller. The following table lists the displayed colors and their associated value range.

Color	Quality Value Range
Red	< 15
Orange	≥ 15 and < 20
Yellow	≥ 20 and < 30
Green	> 30

Note: For more information on KB Basecaller and Quality Values, see the *ABI PRISM® DNA Sequencing Analysis Software v5.0 User Guide, PN 4331940*.

The column is empty (white) if:

- Analysis was not performed
- Analysis failed
- ABI Basecaller was used for analysis. This basecaller does not assign Quality Values.

Results Group and Analysis Protocol Columns The Results Group and the Analysis Protocol (Analysis Method in the GeneMapper™ software) can be edited and the changes used for reextraction.

Note: Select an entire column in the Reextraction window by clicking on the column header. For example, clicking on the Extract column header selects all samples. Clicking the Uncheck or Check buttons at the bottom of the window, enables or disables the checkboxes for each sample. Additionally, the fill-down command (Ctrl+D) works the same here as in the Plate Editor for easier information input.

Sorting The Samples The samples can be sorted according to any of the column properties by holding down the shift key while clicking on the column header. Shift-clicking again sorts them in the reverse order. This is most useful for sorting by capillary number, by well position, by results, by quality, and by the Extract column. For example, it is often useful to bring all of the samples that failed analysis or extraction to the top of the column where they can be examined without having to scroll down to each sample individually.

**Reextracting
Selected
Samples**

To reextract selected samples:

1. Expand the Results column cells for any yellow or red results, to see a description of the warning or failure.
2. If desired, select a new Results Group, or edit the current one. This allows you to turn off autoanalysis, change the samples and folder naming options, the location where they are placed, the owner of the Results Group, etc.
For more Results Group information see, sequencing page 2-12, fragment analysis page 3-13.
3. If desired, change the Analysis Protocol to experiment with different ways of analyzing the sample, using a different basecaller for example.
4. Check the checkbox in the Extract column for the samples you wish to extract again.
5. Click **Extract**.

IMPORTANT! Reextraction creates an entirely new sample file and does not replace the previously saved sample file. The presence of a previous sample file has no effect on the creation of a new sample file. If the same naming options that are used for reextraction are identical to those used previously, a number is appended to the filename. For example, if the first sample is, “sample 01.ab1” then the second sample would be, “sample 01 (1).ab1.”

Viewing Analyzed Data

Locating Sample Files

When a run is finished, the analyzed sample files are extracted into a run folder, along with a run log, to a location defined by your Results Group (For more Results Group information, see page 2-37 for sequencing, or page 3-29 for fragment analysis) or the default destination location:

E:\AppliedBiosystems\UDC\Data Collection\Data\ga3730\Instrument Name

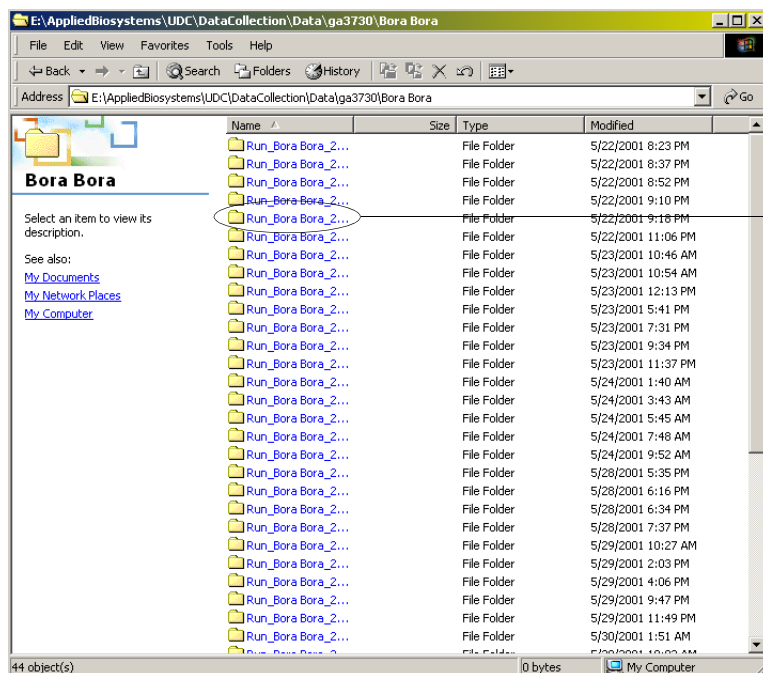

Figure 1-57 Locating Sample Files

If the data has been re-extracted, the data is in the location defined by the applied Results Group or the default destination location:

E:\AppliedBiosystems\UDC\Data Collection\Data\ga3730\Instrument Name

Viewing Sample Files

After a run has been extracted to sample files, you can use the Sequencing Analysis Software v5.0, or the GeneMapper™ Software v3.0 to view the electropherogram data, both raw and analyzed. All sequencing sample files contain the .ab1 extension, and all fragment analysis sample files contain the .fsa extension.

Log Files Log file for a run is stored in the Run name folder found at:

E:\AppliedBiosystems\UDC\DataCollection\Data\ga3730\
Instrument Name\Run_Inst.Name_Date_Run\

IMPORTANT! If the run is not set up for autoanalysis, refer to the ABI PRISM® DNA Sequencing Analysis Software v5.0 User Guide, or the GeneMapper™ Software v3.0 User Guide for information on manual analysis. If the run is set up for autoanalysis, continue to:

- Chapter 2 for sequencing applications and,
- Chapter 3 for fragment analysis applications

3730/3730xl Data Collection Software and DNA Sequencing

2

In This Chapter	3730/3730xl Data Collection Software and ABI Prism Sequencing Analysis Software v5.0	2-2
	About Plate Records and Sequencing	2-4
	Using the Plate Manager for Sequencing	2-5
	Working With a Results Group	2-12
	Creating an Instrument Protocol For Sequencing	2-23
	Working with Analysis Protocols for Sequencing.	2-28
	Plate Search	2-37

3730/3730xl Data Collection Software and Sequencing Analysis Software v5.0

- Important Notes**
- A unique name must be assigned to the instrument computer before 3730/3730xl Data Collection software is installed.
 - Do not rename the computer once 3730/3730xl Data Collection software has been installed. Doing so may cause the 3730/3730xl Data Collection software to malfunction.
 - The 3730/3730xl Data Collection software does not allow all types of characters when naming samples, files, etc.
 - You may, however, change what characters are allowed by modifying the user properties text file. For more information refer to:
E:\AppliedBiosystems\UDC\DataCollection\Config\UserProperties.txt

Acceptable Characters

The following table includes characters that are accepted by default.

Acceptable Character	Description
'	Accent
&	Ampersand
'	Apostrophe
{ }	Braces
[]	Brackets
^	Caret (circumflex)
\$	Dollar
!	Exclamation
()	Parentheses
+	Plus
;	Semicolon
~	Tilde
V	'v' key

IMPORTANT! If an application, 3730/3730xl Data Collection for example, needs to replace an illegal character in the file name, you should replace it with an *underscore* (_).

Unacceptable Characters

The following table includes characters that are *not* allowed.

Unacceptable Character	Description
/ \ //	Forward or backward slash
:	Colon
*	Asterisk
?	Question mark
"	Quotation mark
< >	Inequality signs
	Vertical line
	Space

Sequencing Analysis

Overview You may choose to perform autoanalysis of sequencing samples by utilizing features of the 3730/3730xl Data Collection and ABI PRISM® Sequencing Analysis Software v5.0.

Autoanalysis Autoanalysis can only be performed on the same instrument computer that collected the sample files. Additionally, if you perform autoanalysis on samples, but wish to edit/review results on another computer, you must transfer the Analysis Protocol to the Sequencing Analysis Software v5.0 database. If you wish to analyze samples on another computer, you must transfer the files to that location.

When completing the Plate Record, you need to fill in Instrument Protocol information for Data Collection to complete the run. Additionally, when creating a new Results Group for a set of samples to be autoanalyzed, you must check the “Do Autoanalysis” checkbox in the Analysis tab of the Results Group Editor, and choose default Analysis Protocols for each run.

Manual Analysis If the run is not set up for autoanalysis, refer to the ABI PRISM®DNA Sequencing Analysis Software v5.0 User Guide, or for fragment analysis, the GeneMapper™ Software v3.0 User Guide for information on performing manual analysis.

About Sequencing Analysis and 3730/3730xl Data Collection When Sequencing Analysis Software v5.0 is installed on a computer that has Applied Biosystems 3730/3730xl DNA Analyzer Data Collection Software, Sequencing Analysis becomes available for selection through the Results Group Editor (see page 2-37) and the New Plate Dialog (see page 2-6). This choice enables Data Collection to generate .ab1 files, and either performs Autoanalysis within Data Collection or manual analysis within Sequencing Analysis Software v5.0.

About Plate Records and Sequencing

Overview A plate record is similar to a sample sheet or an injection list that you may have used with other ABI PRISM instruments.

Plate records are data tables in the instrument database that store information about the plates and the samples they contain. Specifically, a plate record contains the following information:

- Plate name, type, and owner
- Position of the sample on the plate (well number)
- Sample name, see page 2-17
- Mobility file (in Analysis Protocol), see page 2-29
- Comments about the plate and about individual samples
- Dye set information (in Instrument Protocol), see page 2-25
- Name of the run module (run modules specify information about how samples are run) (in Instrument Protocol), see page 2-25
- Name of the Analysis Module—Analysis Modules specify how data is analyzed at the end of the run (in Analysis Protocol and Results Group), see page 2-37

When to Create a Plate Record A plate record must be created for each plate of samples for the following types of runs:

- Spectral calibrations
- Sequencing Analysis

Additionally, Plate Records must be created in advance of placing the plates on the instrument. However, Plate Records can be created while a run is in progress.

Using the Plate Manager for Sequencing

The Plate Manager allows you to search for, create, edit, import, export, and delete Plate Records within the local 3730/3730xl Data Collection database.

To create and complete a New Plate:

1. Click  (Plate Manager).

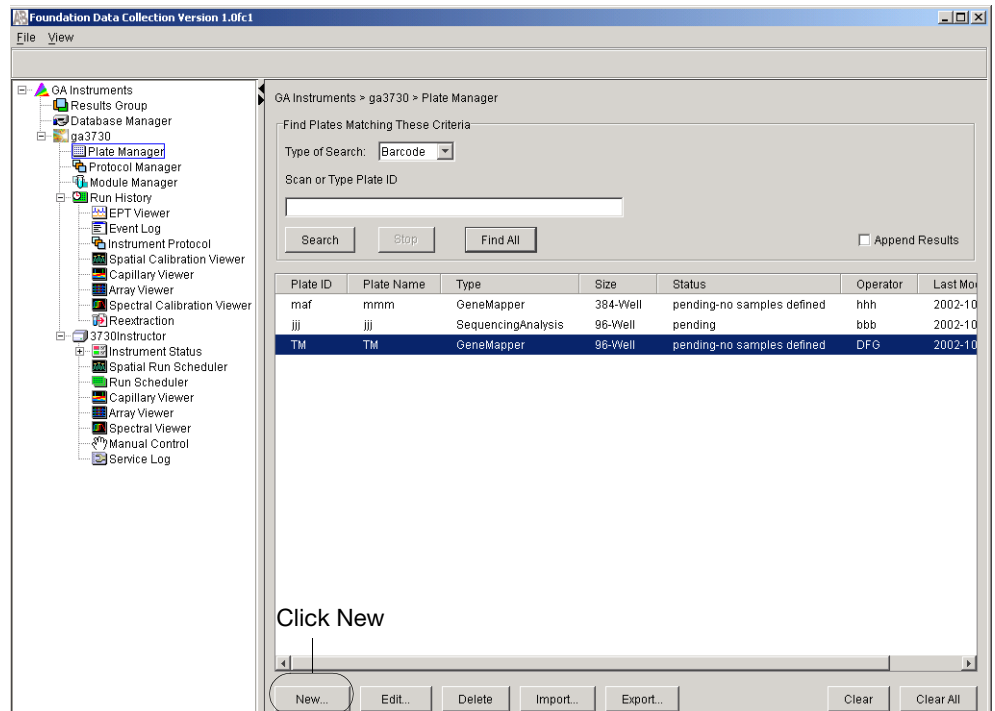

Figure 2-1 Plate Manager Window

2. Click **New** to open the New Plate Dialog box (see figures 2-2 and 2-3 on page 2-7).
3. Use the information in table 2-1 to complete the New Plate Dialog window.
4. Click **OK**.

Elements of the New Plate Dialog Box

The following table describes the elements of the New Plate dialog box that displays when you click New in the Plate Manager window.

Note: All fields except Description are required before clicking OK to create a new Plate Record. For more information on default run scheduling, see page 1-26.

Table 2-1 New Plate Dialog Box Elements

Field	Description
ID (Barcode)*	Plate barcode or other unique ID.
Name*	Unique plate name .
Description	Plate description (optional).
Application	Sets the type of application for the plate. List contains the supported analysis applications: <ul style="list-style-type: none"> • Spectral Calibration • Sequencing Analysis <p>IMPORTANT! What you select here should match the Analysis Type in the Results Group. See page 2-14.</p>
Scheduling	Enables you to customize quadrant run order. Activated when 384-well is selected. see graphics on next page, and see also page 1-26.
Plate Type	Sets the size of the plate for either 96-well or 384-well. see graphics on next page, and see also page 1-26.
Plate Sealing	Sets the sealing type of the plate for either Heat Sealing or Septa.
Owner Name	Contains the name of the plate owner.
Operator Name	Contains the name of the operator who ran the plate.
OK button	Validates the entries in the fields, creates the new Plate Document, and displays it in the Plate Editor window.
Cancel button	Closes the dialog box without creating a new plate.
* The plate (barcode) ID and plate name must be unique to enable database searching for the plate record.	

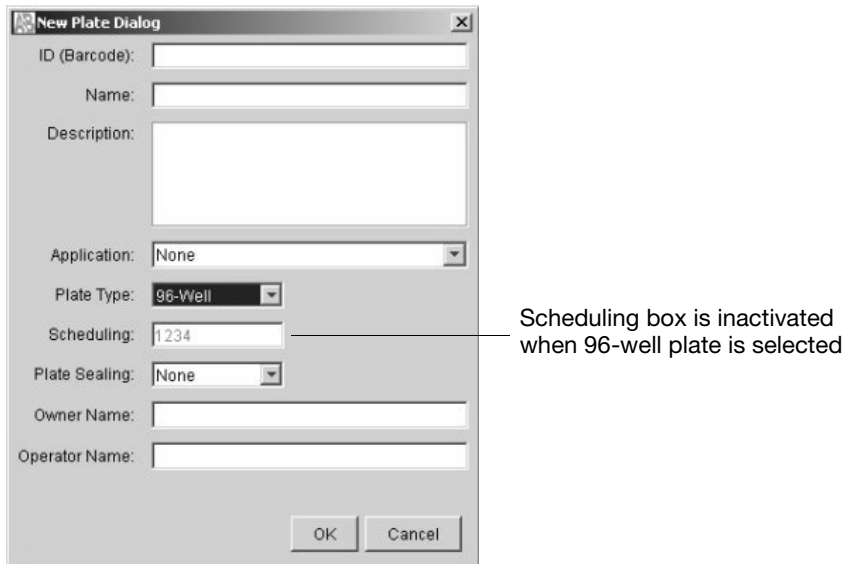

Figure 2-2 96-well plate type selected in New Plate dialog box

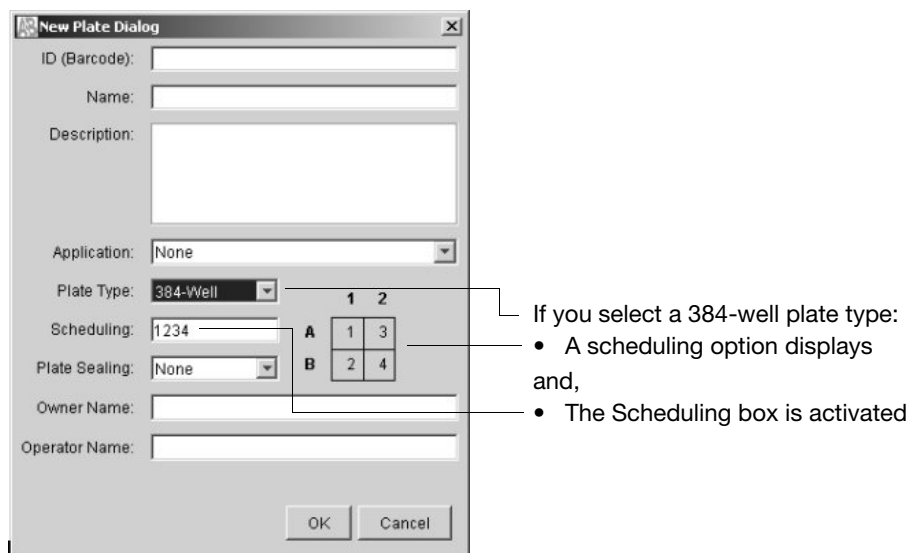

Figure 2-3 384-well plate type selected in New Plate dialog box

About Sequencing Plate Editor

The Plate Editor displays an empty plate record for the selected application that is chosen in the New Plate dialog box. The data fields within a given plate record vary depending on the selected application. This section describes the data fields that are present in a sequencing analysis Plate Record.

The table below lists the parameters in the logical order of their use.

Parameters	Description	See Page
Instrument Protocol	Contains everything needed to run the instrument.	2-23
Analysis Protocol	Contains everything needed to analyze sequencing data.	2-30
Results Group	Defines the file type, the file name, file save locations, and default Analysis Protocols linked to sample injections.	2-12
Plate Manager	Stores and organizes plate records which link samples to the Instrument and Analysis Protocols, and to the Results Group.	2-37

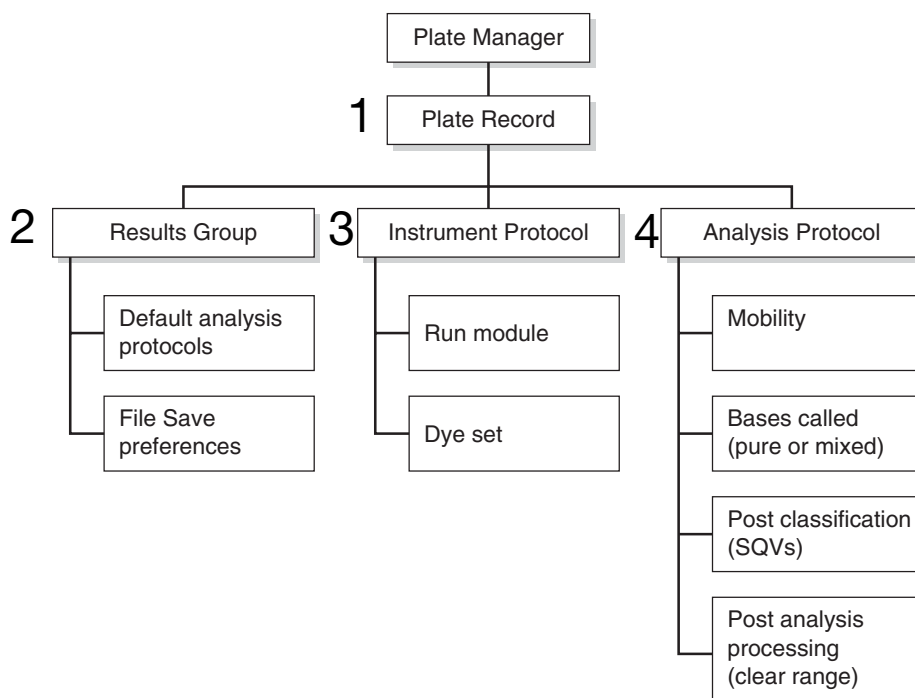

Figure 2-4 Elements of a Plate Record for Sequencing

IMPORTANT! In order for data collection and autoanalysis to be successful, each run of samples must have an Instrument Protocol, an Analysis Protocol, and a Results Group assigned within a plate record.

Completing the Sequencing Plate Editor

To complete the sequencing plate editor:

1. Type a sample name in well A01.
2. Press the **Enter** key.
The entire row of cells are now accessible.
3. Select definitions for:
 - Results Group
 - Instrument Protocol
 - Analysis Protocol

Table 2-2 describes how to create each of the definitions listed above.

Only the Plate Sealing field is editable in this view

The screenshot shows the 'SequencingAnalysis Plate Editor' window. At the top, there are input fields for 'Plate Name' (Seq), 'Plate ID' (VCF), 'Operator' (vcf), 'Owner' (vcf), 'Plate Sealing' (Heat Sealing), and 'Scheduling' (1234). Below these fields is a table with 8 columns: Well, Sample Name, Comment, Results Group, Instrument Protocol 1, Analysis Protocol 1, Instrument Protocol 2, and Analysis Protocol 2. The table contains 24 rows, each representing a well (A01 to G02). The 'Sample Name' column is filled with 'LRS' for all wells. The 'Results Group' column is filled with 'Default_Results_Group'. The 'Instrument Protocol 1' and 'Analysis Protocol 1' columns are filled with 'maf' and '3730BDTv3-KB-DeNo' respectively. The 'Instrument Protocol 2' and 'Analysis Protocol 2' columns are empty. At the bottom of the window, there is a 'Description' field and 'Ok' and 'Cancel' buttons.

Well	Sample Name	Comment	Results Group	Instrument Protocol 1	Analysis Protocol 1	Instrument Protocol 2	Analysis Protocol 2
A01	LRS		Default_Results_Group	maf	3730BDTv3-KB-DeNo		
B01	LRS		Default_Results_Group	maf	3730BDTv3-KB-DeNo		
C01	LRS		Default_Results_Group	maf	3730BDTv3-KB-DeNo		
D01	LRS		Default_Results_Group	maf	3730BDTv3-KB-DeNo		
E01	LRS		Default_Results_Group	maf	3730BDTv3-KB-DeNo		
F01	LRS		Default_Results_Group	maf	3730BDTv3-KB-DeNo		
G01	LRS		Default_Results_Group	maf	3730BDTv3-KB-DeNo		
H01	LRS		Default_Results_Group	maf	3730BDTv3-KB-DeNo		
I01	LRS		Default_Results_Group	maf	3730BDTv3-KB-DeNo		
J01	LRS		Default_Results_Group	maf	3730BDTv3-KB-DeNo		
K01	LRS		Default_Results_Group	maf	3730BDTv3-KB-DeNo		
L01	LRS		Default_Results_Group	maf	3730BDTv3-KB-DeNo		
M01	LRS		Default_Results_Group	maf	3730BDTv3-KB-DeNo		
N01	LRS		Default_Results_Group	maf	3730BDTv3-KB-DeNo		
O01	LRS		Default_Results_Group	maf	3730BDTv3-KB-DeNo		
P01	LRS		Default_Results_Group	maf	3730BDTv3-KB-DeNo		
A02	LRS		Default_Results_Group	maf	3730BDTv3-KB-DeNo		
B02	LRS		Default_Results_Group	maf	3730BDTv3-KB-DeNo		
C02	LRS		Default_Results_Group	maf	3730BDTv3-KB-DeNo		
D02	LRS		Default_Results_Group	maf	3730BDTv3-KB-DeNo		
E02	LRS		Default_Results_Group	maf	3730BDTv3-KB-DeNo		
F02	LRS		Default_Results_Group	maf	3730BDTv3-KB-DeNo		
G02	LRS		Default_Results_Group	maf	3730BDTv3-KB-DeNo		

Figure 2-5 A Completed Sequencing Plate Record

4. Click **OK**.

Note: For sequencing runs, there is no need to re-create a plate record for a run that may have failed. Simply edit the plate record to add an Instrument Protocol and an Analysis Protocol to the rows that need to be rerun (only if the plate has available blank Protocol fields). This changes the existing plate record status from “Processed” to “Pending.”

IMPORTANT! You must have sufficient database space available to create new protocols within an open plate record. The Database Manager alerts you if there is not enough space. To free up space, see page 5-32.

IMPORTANT! After clicking OK within the Plate Editor, the completed plate record is stored in the Plate Manager database. Once in the Plate Manager database, the plate record can be searched for, edited, exported, or deleted.

However, editing plates during extraction causes extraction results to be overwritten. If, for example, you create a plate with two or more runs and then run the plate. When the first run is extracting, you open the plate editor and make some changes and then save the results. When you then view the run in the re-extraction panel, some of the Analysis results may be blank, having been overwritten by the Plate Editor.

The following table describes the columns inserted in a Plate Record for a sequencing analysis run.

Table 2-2 Columns in the Sequencing Analysis Plate Record

Column	Description
Sample Name	Name of the sample
Comment	Comments about the sample (optional)
Results Group Note: Not provided for Spectral runs	Some options: <ul style="list-style-type: none"> • New: Opens the Results Group Editor dialog box • Edit: Opens the Results Group Editor dialog box for the Results Group listed in the cell • None: Sets the cell to have no selected Results Group Note: You must have a Results Group selected for each sample entered in the Sample Name column. See, "Working With a Results Group" on page 2-12
Instrument Protocol	<ul style="list-style-type: none"> • New: Opens the Protocol Editor dialog box. An alert displays if there is not sufficient space. • Edit: Opens the Protocol Editor dialog box for the Instrument Protocol listed in the cell. • None: Sets the cell to have no selected protocol. • List of Instrument Protocols: In alpha-numeric order. Note: You must have an Instrument Protocol selected for each sample entered in the Sample Name column. See, "Creating an Instrument Protocol For Sequencing" on page 2-23
Analysis Protocol Note: Not provided for Spectral runs	<ul style="list-style-type: none"> • New: Opens the Analysis Protocol Editor dialog box. An alert displays if there is not sufficient space. • Edit: Opens the Analysis Protocol Editor dialog box for the Instrument Protocol listed in the cell. • None: Sets the cell to have no selected protocol. • List of Analysis Protocols: In alpha-numeric order Note: You must have an Analysis Protocol selected for each sample entered in the Sample Name column. See, "Working with Analysis Protocols for Sequencing" on page 2-28

Working With a Results Group

Overview A Results Group is a component within Data Collection that organizes samples and certain user settings under a single name. It is called a Results Group because it is used to analyze, name, sort, and deliver samples that result from a run.

You can create a Results Group two different ways:

- Within the Plate Record
- or,
- Within the left navigation pane under GA Instruments.

Creating a Results Group To create a Results Group:

1. Click:
 - a. Click  (Results Group) to display the Results Group Manager.
 - or,
 - b. In the Plate Record, click New under Results Group column.

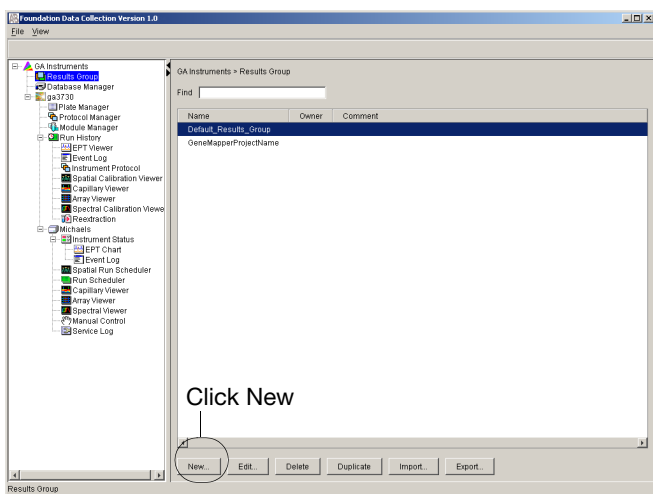

Figure 2-6 Create a Results Group in the left navigation pane under GA Instruments

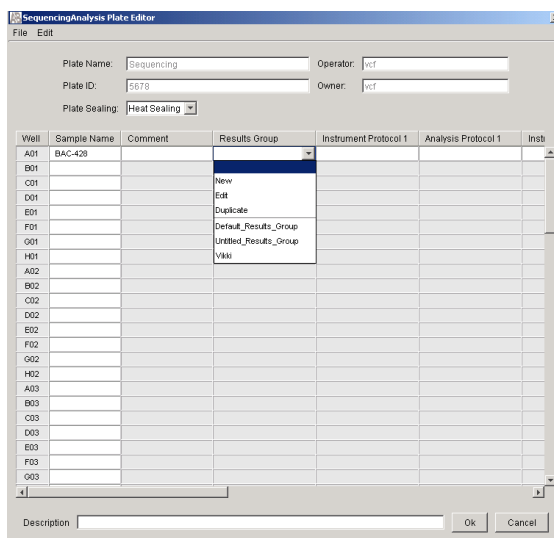

Figure 2-7 Create a Results Group in the Plate Record

2. Click **New** or highlight an existing group and click **Edit**.

The Results Group Editor window displays.

Note: Do not select **Results Group Entry Completed** for sequencing analysis.

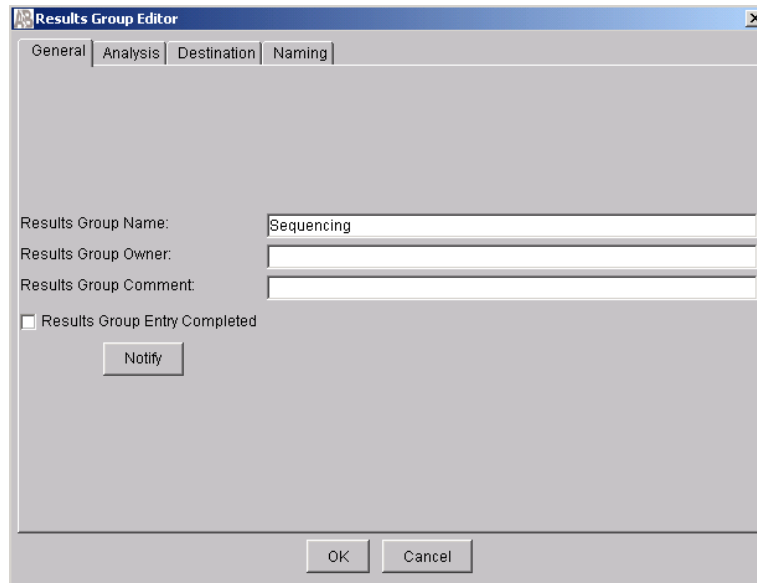

Figure 2-8 General tab in the Results Group Editor

Results Group Editor Tabs

Each tab in the Results Group Editor window is described below.

General Tab

To complete the **General** tab (see figure 2-8):

1. Type a Results Group Name. The name can be used in naming and sorting sample files. It must be unique (see page for a list of accepted characters).
2. Type a Results Group Owner. The owner name can be used in naming and sorting sample files.
3. Type a Results Group Comment (optional).

Analysis Tab: Autoanalysis If Analysis protocols are defined here for runs 1-5, the Plate Editor record is automatically populated during the creation of a plate record.

To complete the Analysis tab for Autoanalysis with sequencing analysis:

1. Select the **Analysis** tab.
2. Select **Do Autoanalysis** checkbox.
3. Select **Sequencing Analysis** from the Analysis Type drop-down list.
4. Select **Default Analysis Protocols Runs 1–5** from each of the five Run menus. This links a Results Group to an Analysis Protocol in the Plate Record. Once you select a Results Group in a Plate Record, the Analysis Protocols automatically populate the Plate Record according to the defaults chosen here. With these settings, a set of 48 or 96 samples may be run up to five consecutive times within the same plate record.

Note: The Analysis Protocols chosen here are only used as default settings in the Plate Editor. Changing the choices in the Results Group has no effect on any plates that have already been created, and has no effect on which protocols are used in extraction.

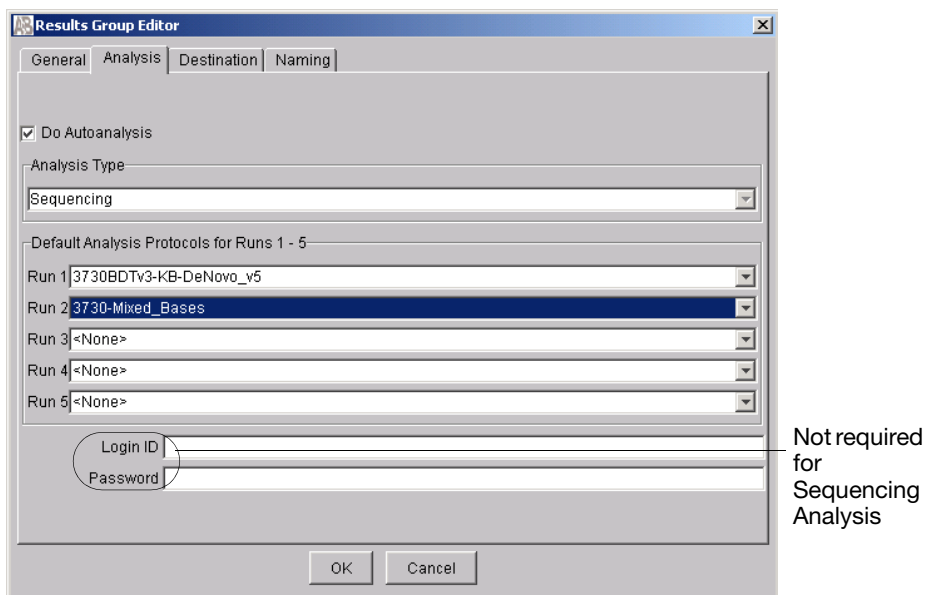

Figure 2-9 Analysis tab: Autoanalysis

**Analysis Tab:
Manual Analysis**

To complete the Analysis tab for Manual analysis:

1. Select the **Analysis** tab.
2. Make sure that **Do Autoanalysis** is not selected.
3. Select **<None>** or **Sequencing Analysis** from the Analysis Type drop-down list.
4. Leave the **Default Analysis Protocols Runs 1–5** as **<None>**.

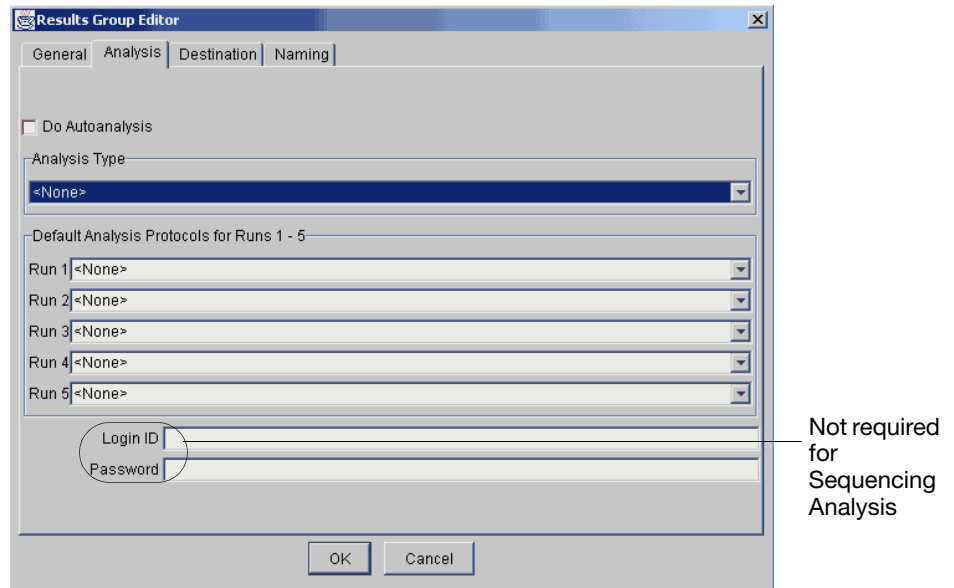

Figure 2-10 Analysis tab: Manual analysis

Destination Tab

The Location field shows where the sample files are to be placed during extraction. The location can be anywhere on the same computer or on a different computer that is locally accessible.

For each new Results Group opened, the Location path shows the default path for saving sample files.

To save to a location other than the default location:

1. Select the Destination tab.
2. Select **Use Custom Location**, then click **Browse** to navigate to a different save location.
3. Click **Test** to test the Location path name connection:
 - a. If it passes, a message box displays, “Path Name test successful.”
 - b. If it fails, an error box displays, “Could not make the connection. Please check that the Path Name is correct.” Click and retry to establish a connection.

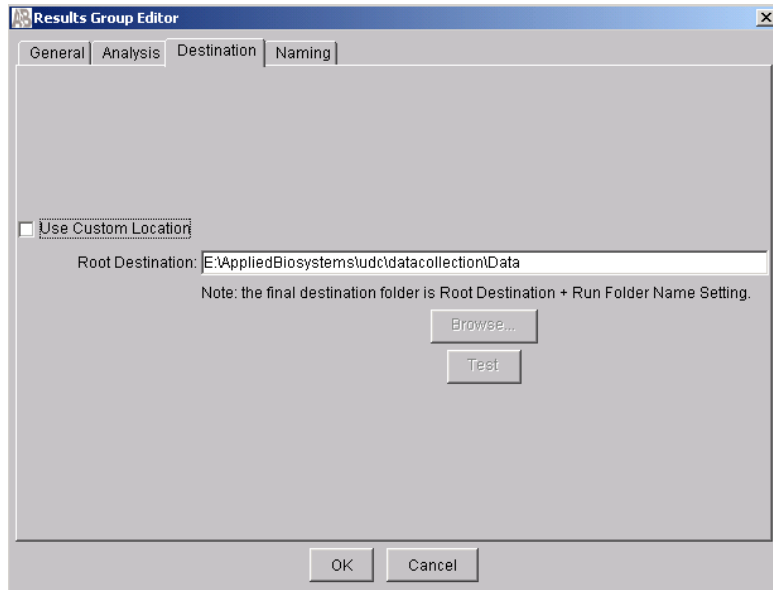

Figure 2-11 Destination tab in the Results Group Editor Window

Naming Tab Use the Naming tab to customize sample file and run folder names.

IMPORTANT! Sample name, run folder name, and path name, *combined*, can total no more than 250 characters. See page 2-2 for accepted characters.

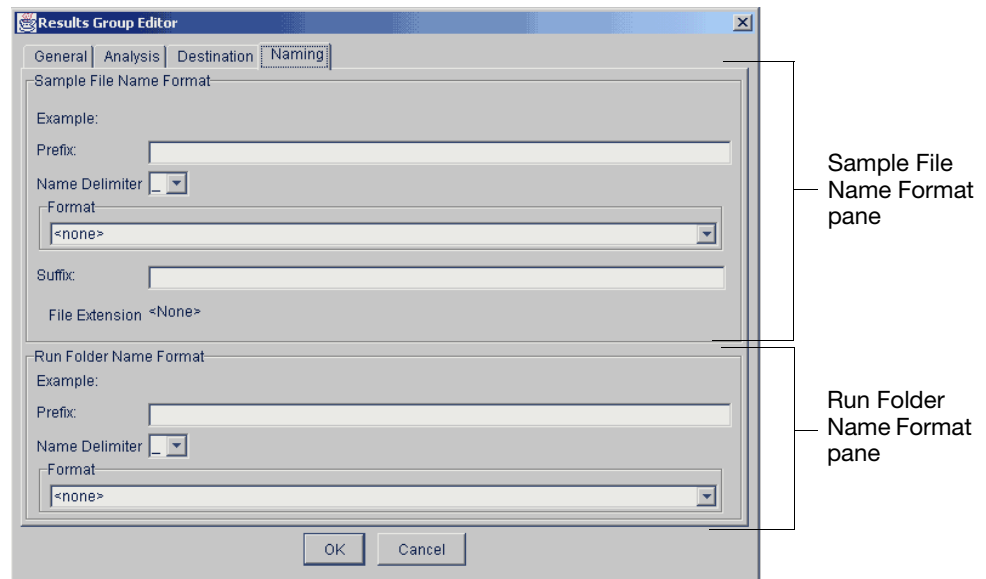

Figure 2-12 Naming tab in the Results Group Editor Window

The elements of the Naming tab are discussed in the following sections.

Sample File Name Format Pane

Follow the procedure below to complete the Sample File Name Format pane.

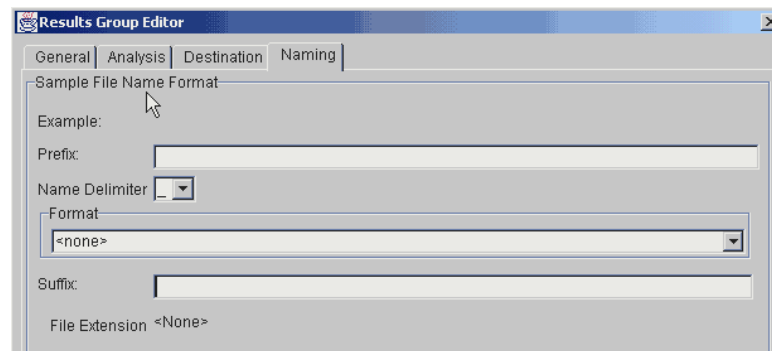

Figure 2-13 Sample File Name Format Pane

1. Select the **Naming** tab.
2. Click the **Prefix** box (optional) to type a prefix for the file name. Anything that you type here is shown in the Example line (see graphic below).

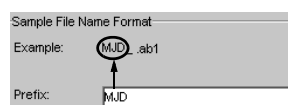

Figure 2-14 Prefix Box

- Click the **Name Delimiter** list choose the symbol that will separate the Format elements in the file name (see step 3 below). Only one delimiter symbol may be chosen.

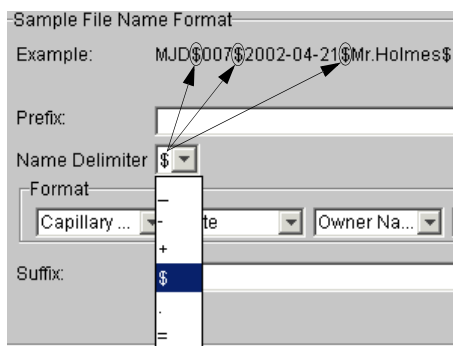

Figure 2-15 Name Delimiter List

- Click the **Format** list and then select the components that you want in the sample name.

Note: Generally, all the samples from a single run are placed in the same run or results folder, so the name of every sample from a single run should be different. Most of the Format options will not be different between samples, so you need to take care to select at least one of the options that make the sample names unique within a run.

For example, if a unique identifier is not included in the name, a warning message displays. The Results Group makes the file name unique. As you select the elements for the file name, they are reflected in the Example line (see figure 2-16).

For more information on unique identifiers, see page 2-21.

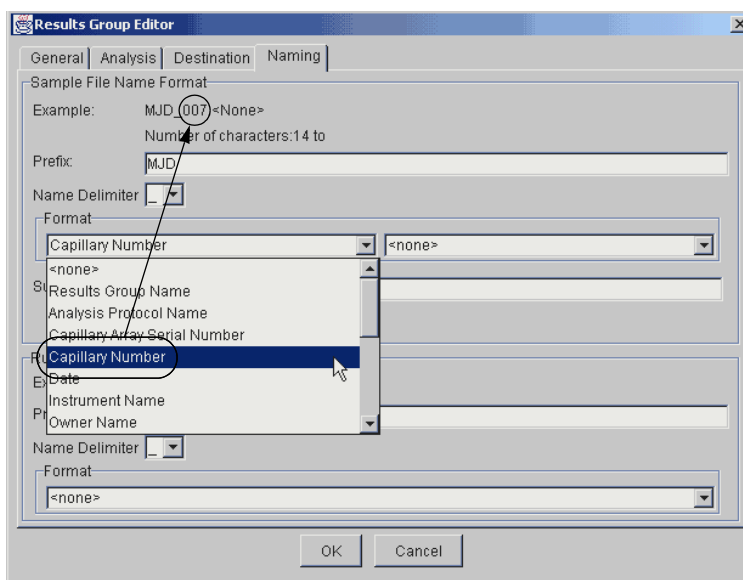

Figure 2-16 Format list.

The Example field shows an updated example of all the elements you have added to make a unique sample file name.

As you continue to select elements for the file name, additional elements display (see figures 2-17 and 2-18).

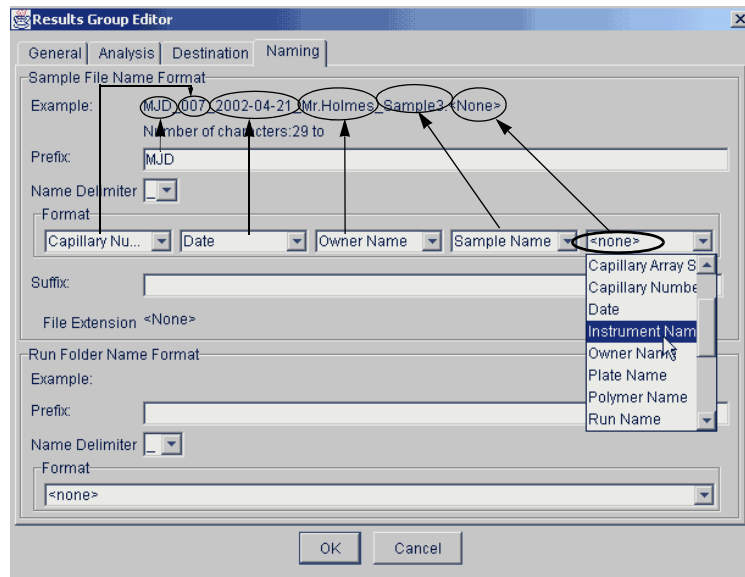

Figure 2-17 As you select more elements for the file name, additional elements display...

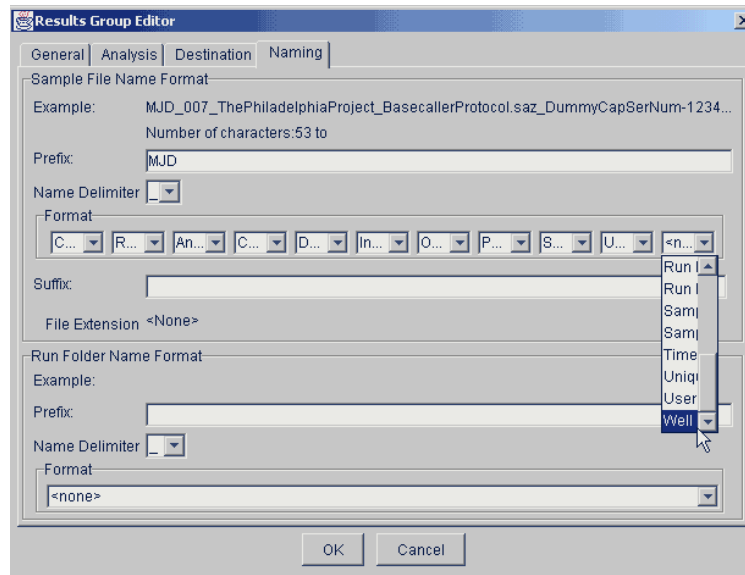

Figure 2-18 ...the names of the Format elements eventually truncate, but the Example field remains visible (up to 72 characters).

- Click the **Suffix** box (optional) and type the suffix for the file name.

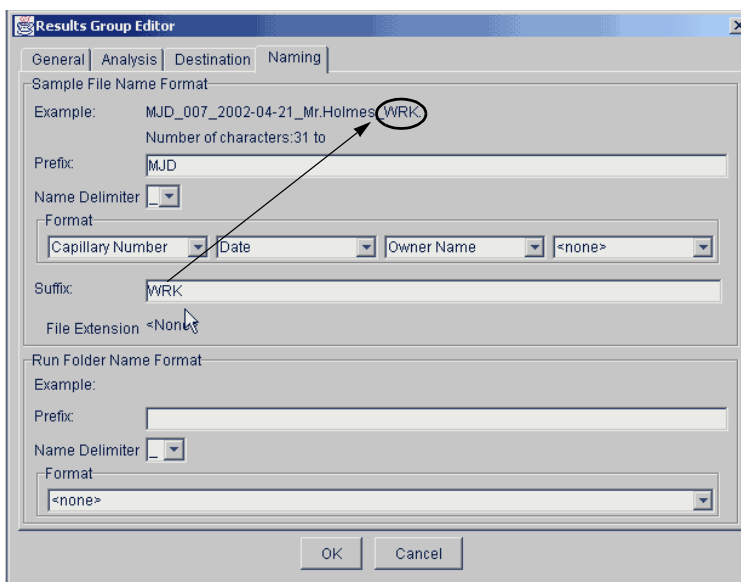

Figure 2-19 Type a suffix and it displays at the end of the file name.

The File Extension field displays the file extension generated from the Analysis Type specified on the **Analysis** tab (page 2-14). For example, Sequencing Analysis produces sample files with an .ab1 extension.

Run Folder/Sub-Folder Name Format Pane

Follow the same steps described above for the Sample File Name Format pane (page 2-17) to change the sub-folder name within the run folder.

Saving a Results Group

To save a Results Group:

- Click **OK** from any tab once all the elements within the Results Group have been chosen.

IMPORTANT! You must select at least one Format element for the Sample file and the Run folder names in order to proceed within the Results Group.

Note: Even if you create a custom run folder location, a separate default run folder is generated that contains the log file.

About Format Elements (Unique Identifiers)

While you may select a minimum of just one Format element for the Sample file and Run folder names in order to save a Results Group, selecting just the minimum may not provide enough information for you to identify the file or folder later.

For example:

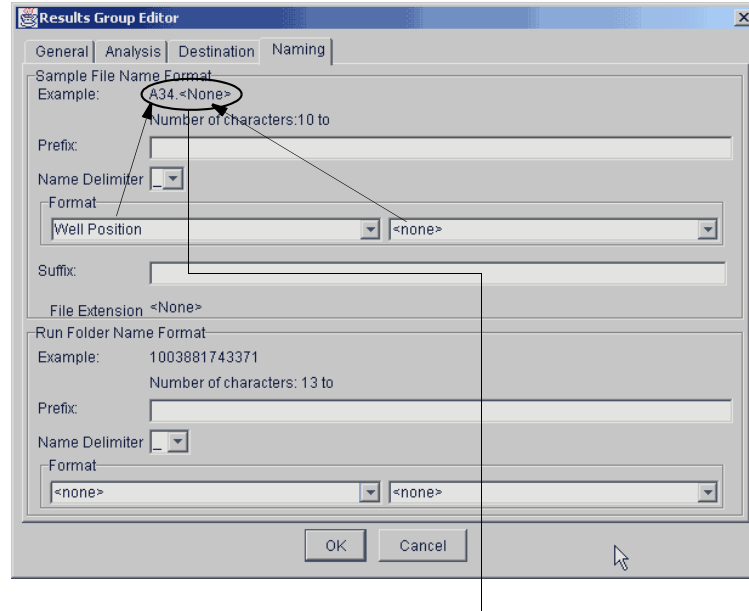

Figure 2-20 Although acceptable, the 'A34' sample file name above (well position) may not be helpful when trying to locate and identify the file later.

If you choose elements from the Format lists that do not create unique Sample file or Run folder names, a warning message displays below the Example line (see figure 2-22).

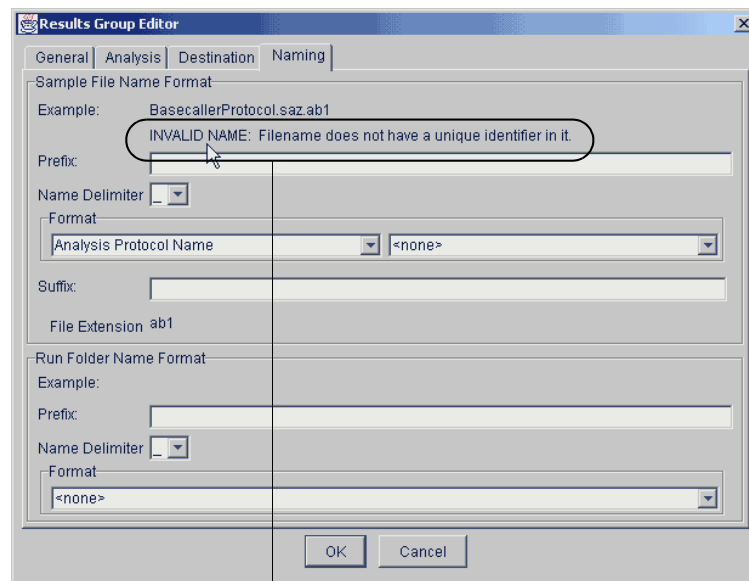



Figure 2-21 Warning indicates that the Sample file name does not have a unique identifier.

To remove the warning message and proceed within the Results Group Editor window, simply select a Format element that distinguishes one file from another (for example, the capillary number is unique while the instrument name is not).

Importing and Exporting a Results Group

Results Groups can be imported from, or exported to, tab-delimited text files. This allows easy sharing of identical Results Groups between instruments.

To import a Results Group:

1. Click  (Results Group) to display the Results Group Manager.
2. Click **Import**.

A standard File Import dialog box displays.

3. Navigate to the file you want to import.

Note: Import file type is .txt (text).

4. Click **Open**.

Note: When you import or duplicate a Results Group, you are asked to type a name for the new Results Group and for the analysis application type.

To export a Results Group:

1. Click  (Results Group) to display the Results Group Manager.
2. Click the Results Group name to select it.
3. Click **Export**.

A standard file export dialog box displays with the chosen Results Group name.

4. Navigate to the location where you want to save the exported file.
5. Click **Save**.

Note: If there is a name conflict with a Results Group that already exists at the save location, the Results groups can be duplicated in order to copy settings into a similar Results Group without the risk of user error when copying it manually (see procedure below).

To Duplicate a Results Group:

1. Click the Results Group to select it.
2. Click **Duplicate**.

Note: When you import or duplicate a Results Group, you are asked to type a name for the new Results Group and for the analysis application type.

Creating an Instrument Protocol For Sequencing

Important Information

IMPORTANT! You must perform a spatial and a spectral calibration run before a sequencing run can be successfully processed. Also, you must set up an Instrument Protocol for each sample in a run.

The Applied Biosystems 3730/3730xl DNA Analyzer Data Collection Software contains several new features that are briefly described here and in more detail throughout this section.

Creating an Instrument Protocol

You can create an Instrument Protocol two different ways:

- Within the Plate Record
- or,
- Within the Protocol Manager.

To create an Instrument Protocol:

1. Click:
 - a. the Protocol Manager icon  to display the Protocol Manager window.
 - or,
 - b. In the Plate Record, click **New** under the Instrument Protocol column.

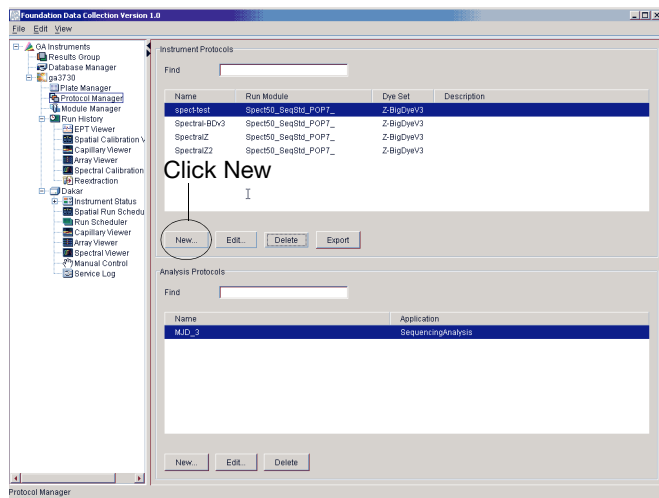

Figure 2-22 Create an Instrument Protocol in the Protocol Manager

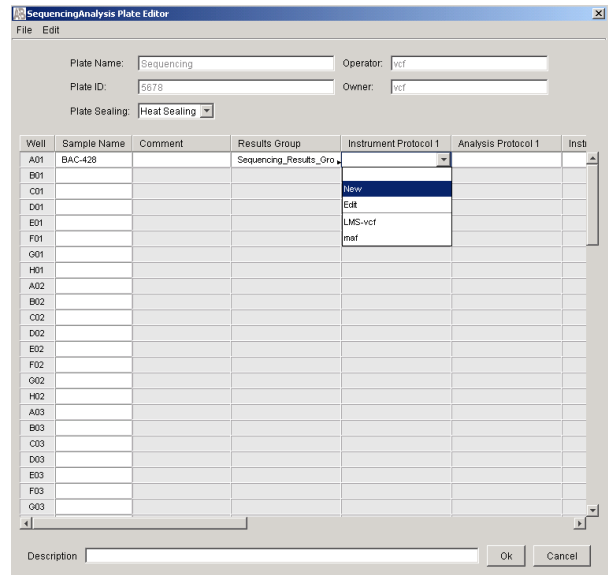

Figure 2-23 Create an Instrument Protocol in the Plate Record

2. Select **New** in the Instrument Protocols section.
This opens the Protocol Editor window (see figure 2-25).

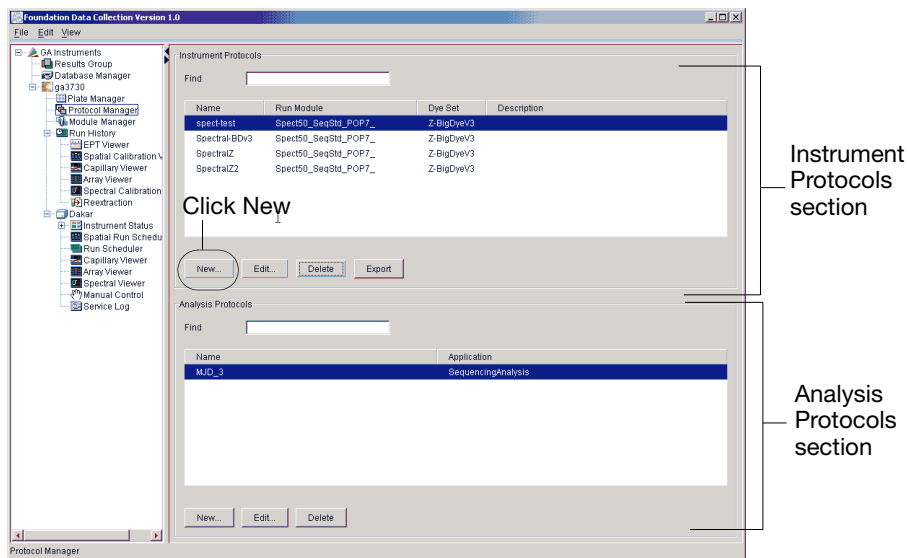

Figure 2-24 Opening the Protocol Editor Window

The Protocol Editor opens when you create a new Instrument Protocol in the Plate Record or in the Protocol Manager.

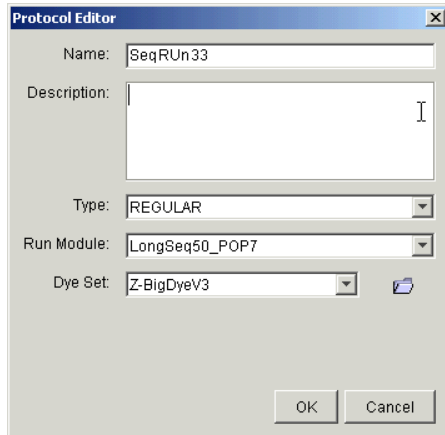

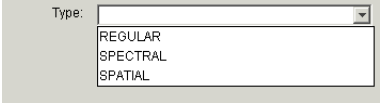
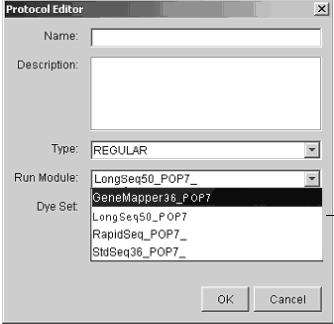
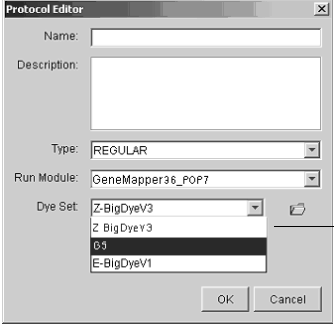

Figure 2-25 Protocol Editor window

Using the Protocol Editor Window

Use the table below to complete the Protocol Editor window.

Text Fields and Menu Choices	Action
<p>Name</p> 	<p>Type the name of the protocol (required).</p>
<p>Description</p> 	<p>Type any descriptions that will help identify the protocol later (optional).</p>
<p>Type</p> 	<p>Select the appropriate run type from the Type list. Note: Select Regular for Sequencing</p>
<p>Run Module</p> 	<p>Select the appropriate run module from the Run Module list. For sequencing run module choices, see Table 2-3 on page 2-26. Note: To customize run modules, see page 1-41</p>
<p>Dye Set</p> 	<p>Select the appropriate dye set from the Dye Set list. For sequencing dye set choices, see Table 2-4 on page 2-26</p>

Select the run module from the table below.

Table 2-3 Run Modules

Analysis Type	Capillary Array Length	Run Module
Long DNA sequencing	50cm	LongSeq50_POP7
Standard read DNA sequencing	36cm	StdSeq36_POP7
Rapid read DNA sequencing	36cm	RapidSeq36_POP7

Select the dye set from the table below.

Table 2-4 Sequencing Dye Sets

Chemistry	Dye Set
ABI PRISM® BigDye® Terminator v1.1 Sequencing Standard	E-BigDye v3
ABI PRISM® BigDye® Terminator v3.0 Sequencing Standard	Z-BigDye v3
ABI PRISM® BigDye® Terminator v3.1 Sequencing Standard	Z-BigDye v3

Select **OK** in the Protocol Editor when you have finished creating an Instrument Protocol.

Importing an Instrument Protocol

To import an instrument protocol:

1. Select **Import** in the Instrument Protocols pane of the Protocol Editor window.



Figure 2-26 Protocol Editor Window

2. Navigate to the protocol you want to import.

Note: Import file type is .txt (text).

3. Double-click the protocol to import it.

The imported file is displayed as the top row in the Instrument Protocol pane.

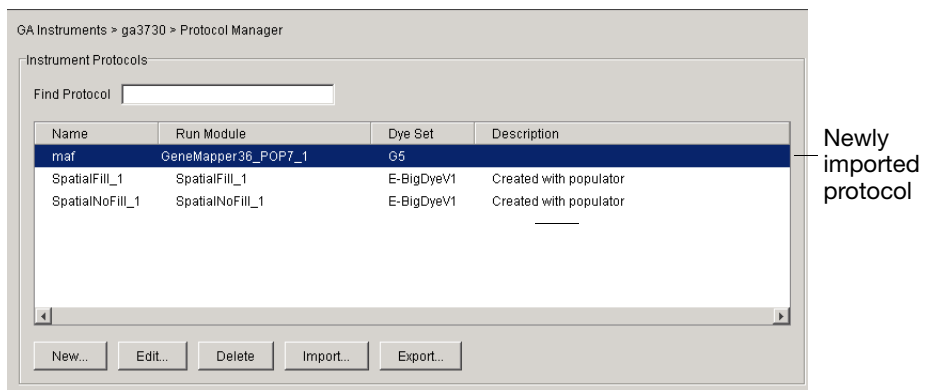

Figure 2-27 Instrument Protocol pane

Working with Analysis Protocols for Sequencing

Sequencing Analysis Software Must be Installed

The ABI PRISM Sequencing Analysis Software v5.0 must be installed and registered with the Applied Biosystems 3730/3730xl DNA Analyzer Data Collection Software before you can create an analysis protocol. Please refer to the *ABI PRISM® DNA Sequencing Analysis Software v5.0 User Guide* (P/N 4331940) for further information.

About Analysis Protocols

New to Data Collection is the implementation of analysis protocols. An analysis protocol contains all the settings necessary for analysis and post processing. A protocol is stored in the sample file.

You can perform autoanalysis from Data Collection via the Analysis Protocol and Results Group settings described in the next two sections.

Basecaller Options

The basecaller options are:

- KB
- ABI

The KB Basecaller:

- Calls mixed bases, if the mixed base option is selected.
Mixed bases are single-sequence positions that may contain a mixture of two bases. The KB Basecaller assigns A, C, G, T, or an IUB code to every base.
- Calls pure bases, if the mixed base option is not selected.
The basecaller assigns A, C, G, or T to every base.
- Calculates sample quality values (QV) for pure and mixed bases. The QV is a per-base estimate of the basecaller accuracy.

The ABI Basecaller:

- Calls *only* A, C, G, or T, and N for ambiguous bases.
- Does not call mixed bases.
- Does not calculate sample quality values (QV).

For more information on basecallers and QV, see the *ABI PRISM® DNA Sequencing Analysis Software v5.0 User Guide*.

Basecaller Options Table

The following table lists the run module, the basecaller, and associated mobility files.

Run Module	Basecaller Name	Mobility File
Long read DNA sequencing	• ABI: Basecaller-3730POP7LR.bcp	DT3730POP7{BD}.mob DT3730POP7{BDv3}.mob
	• KB: KB.bcp	KB_3730_POP7_BDTv1.mob KB_3730_POP7_BDTv3.mob
Standard read DNA sequencing	• ABI: Basecaller-3730POP7SR.bcp	DT3730POP7{BD}.mob DT3730POP7{BDv3}.mob
	• KB: KB.bcp	KB_3730_POP7_BDTv1.mob KB_3730_POP7_BDTv3.mob
Rapid read DNA sequencing	• ABI: Basecaller-3730POP7RR.bcp	DT3730POP7{BD}.mob DT3730POP7{BDv3}.mob
	• KB: KB.bcp	KB_3730_POP7_BDTv1.mob KB_3730_POP7_BDTv3.mob

Creating an Analysis Protocol

IMPORTANT! Do not delete an Analysis Protocol during a run while it is being used for that run. Autoanalysis will not be performed if you do so.

You can create an Analysis Protocol two different ways:

- Within the Plate Record
- or,
- Within the Protocol Manager.

The following parameters are contained in an analysis protocol:

- Protocol name – The name, description of the analysis protocol, and the sequence file formats to be used
- Basecalling settings – The basecaller, DyeSet/Primer file, and analysis stop point to be used
- MixedBases – Option: to use mixed base identification, and if so, define the percent value of the second highest to the highest peak
- ClearRange – The clear range to be used based on base positions, sample quality values, and/or number of ambiguities (Ns) present

To create an analysis protocol:

1. Select:
 - a. **New** within the Protocol Manager window in the Analysis Protocol pane.
 - or,
 - b. Click **New** under the Analysis Protocol column in the Plate Record.

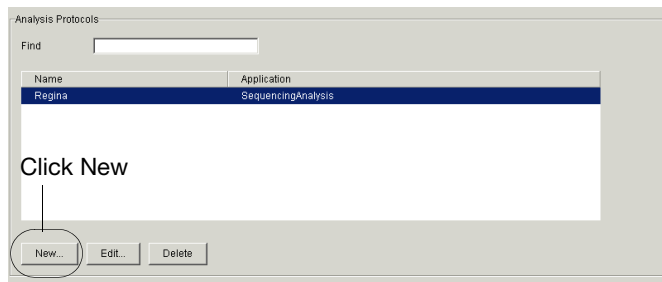

Figure 2-28 Create an Analysis Protocol within the Analysis Protocol pane

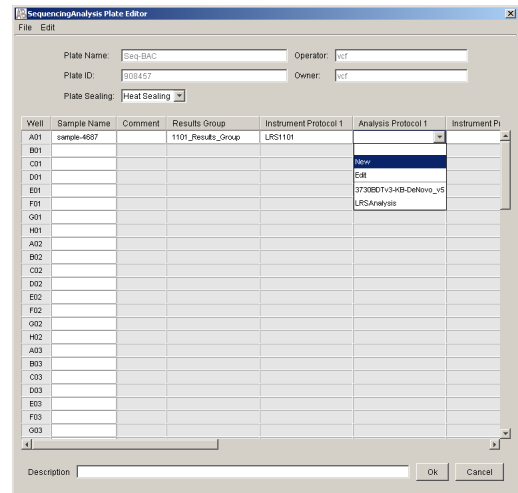

Figure 2-29 Create an Analysis Protocol in the Plate Record

This opens the Sequence Analysis Protocol Editor dialog box.

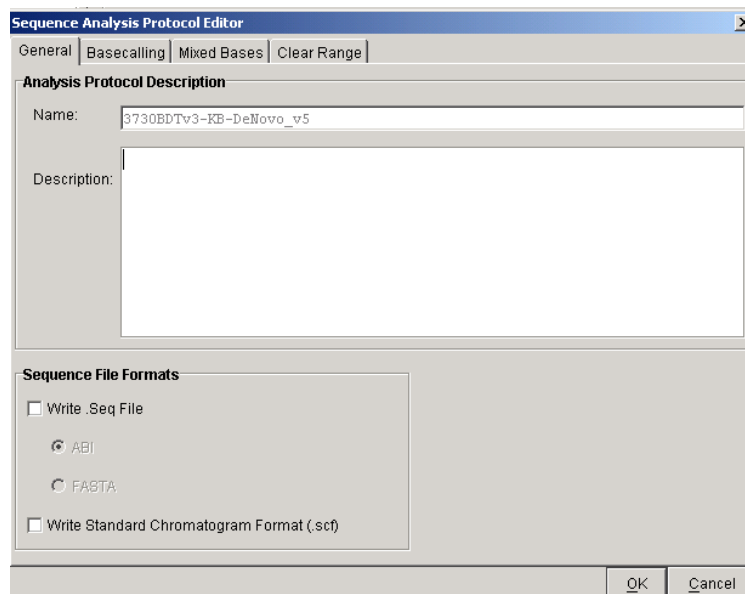

Figure 2-30 Analysis Protocol Editor Window

2. In the **General** tab:
 - a. Enter a unique name and description for the new protocol.
 - b. Select the appropriate Sequence File formats settings.

Option	If checked, the software creates...
Write .Seq File check box	a .seq file for printing the sequence as text file or for using the file in other software. <ul style="list-style-type: none"> • ABI format is used with Applied Biosystems software. • FASTA format is used with other software
Write Simple Chromatogram Format (.scf)	a .scf file that can be used with other chromatogram viewer software. This file contains no raw data.

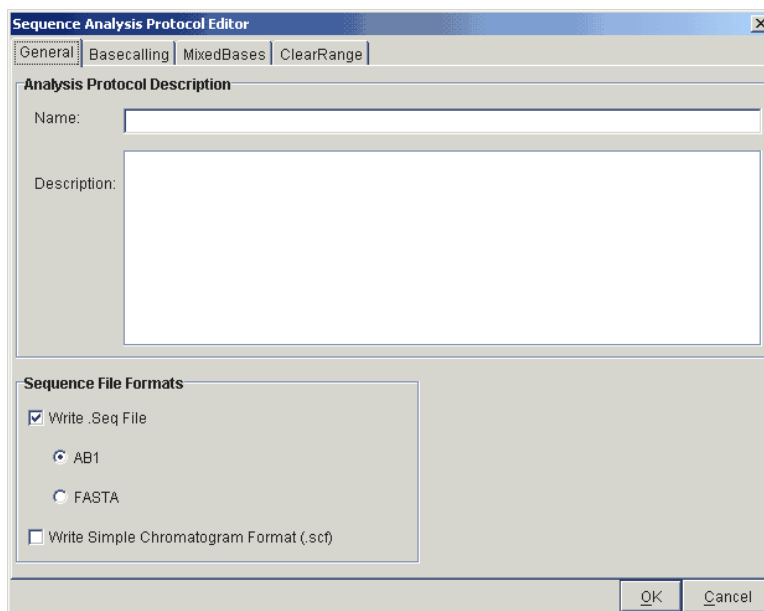

Figure 2-31 General Tab

3. Select the **Basecalling** tab.

Figure 2-32 Basecalling Tab

a. Select the appropriate basecaller.

Basecaller	Description
KB.bcp	Algorithm calculates mixed or pure bases, and sample quality values (QV).
ABI: <ul style="list-style-type: none"> Basecaller-3730POP7LR.bcp Basecaller-3730POP7SR.bcp Basecaller-3730POP7RR.bcp 	Algorithm used in ABI PRISM Sequencing Analysis software v3.7 and higher. It does not calculate mixed or pure bases, or sample quality values (QV). Calls only A, C, G, or T, and N for ambiguous bases.

b. Select the appropriate dye set/primer.

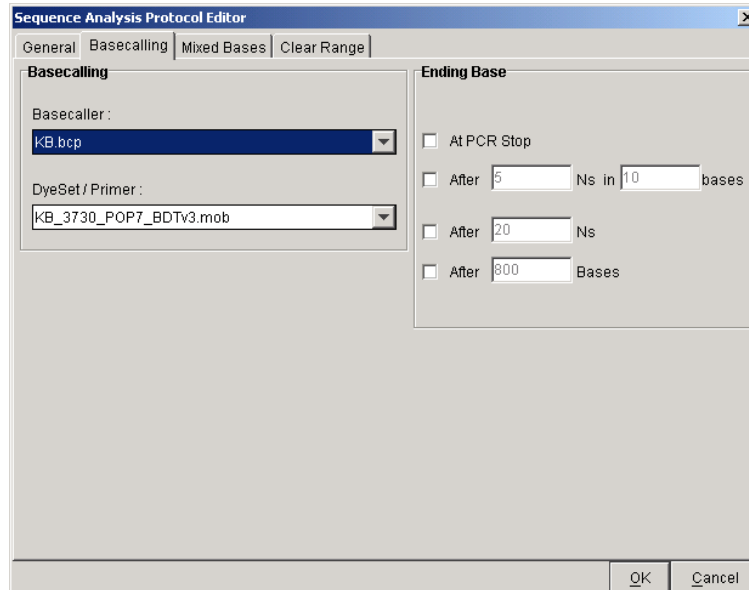
Basecaller	Dye Set/Primer File
KB.bcp	KB_3730_POP7_BDTv1.mob KB3730_POP7_BDTv3.mob
ABI: <ul style="list-style-type: none"> Basecaller-3730POP7LR.bcp Basecaller-3730POP7SR.bcp Basecaller-3730POP7RR.bcp 	DT3730POP7{BD}.mob DT3730POP7{BDv3}.mob

Note: Sequencing Analysis Software v5.0 and 3730/3730xI Data Collection software filter .mob file choices to match the chosen .bcp file.

- c. If desired, select one or more stop points for data analysis. Base your selection on the basecaller being used.

If Using this Basecaller...	Choose this Option
KB or ABI	At PCR Stop check box
ABI	After __ Ns in __ bases check box
ABI	After __ Ns check box
KB or ABI	After __ Bases check box

- 4. Select the **MixedBases** tab.

Note: This function is active with the KB Basecaller only.

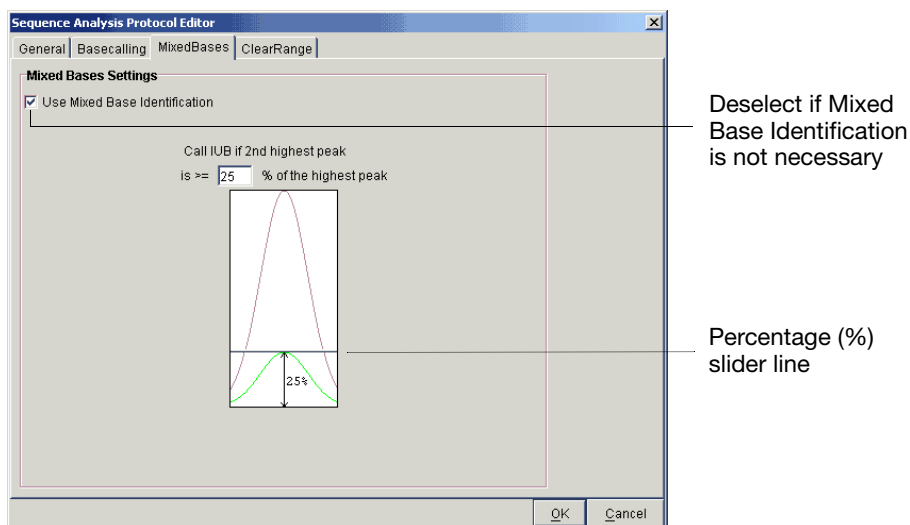

Figure 2-33 MixedBases Tab

- a. If desired, select use Mixed Base Identification.
- b. Use the default setting of 25% or change the detection level by either entering a new value in the text box or use the mouse to drag the percentage slider line up or down.

Note: If mixed base identification is not necessary, deselect. Leaving it selected when it is not necessary could lower overall quality and length of read, and sample quality values.

5. Select the **ClearRange** tab.

Note: The clear range is the region of sequence that remains after excluding the low-quality or error prone sequence at both the 5' and 3' ends.

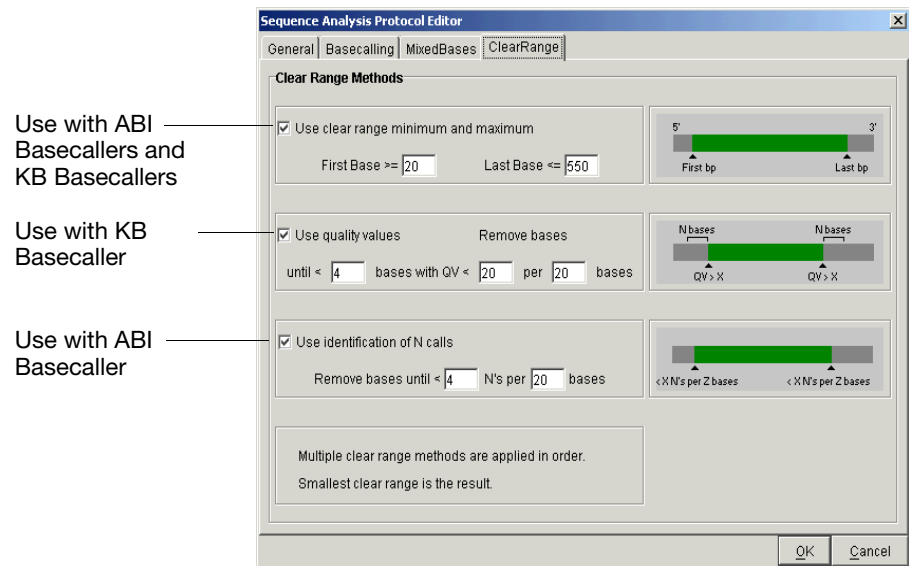

Figure 2-34 ClearRange Tab. A post-processing feature.

6. Select one or more Clear Range methods. If you apply multiple methods, the smallest clear range results.
7. Select **OK** to save the protocol and close the Sequence Analysis Protocol Editor dialog box.

Note: Once you have created an Instrument Protocol and an Analysis Protocol, you are ready to create a Results Group (see “Plate Search” on page 2-37).

Editing an Analysis Protocol

To edit an analysis protocol:

1. In the Analysis Protocols pane in the Analysis Protocol Manager, highlight the protocol you want to edit.
2. Select **Edit**.
3. Make changes in the General, Basecalling, MixedBases and ClearRange tabs, as appropriate.
4. Click **OK** to save the protocol and close the Analysis Protocol Editor dialog box.

Note: The version number for the edited protocol increments by one every time you press OK.

Deleting an Analysis Protocol

To delete an analysis protocol:

IMPORTANT! Do not delete an Analysis Protocol during a run while it is being used for that run. Autoanalysis will not be performed if you do so. Also, You must first delete any plate records using the Analysis Protocol before you can delete or modify the Analysis Protocol for these plate records.

1. In the Analysis Protocols pane in the Analysis Protocol Manager, highlight the protocol you want to delete.
2. Click **Delete**.
The Deletion Confirmation dialog box displays.
3. Click **Yes**.

Plate Search

Barcode or Advanced Plate Search

Within the Plate Manager, you may search for plates in the **Type of Search** list by clicking either **Barcode** or **Advanced**. A different window displays for each choice. Both are described below.

Barcode Search Window

The Barcode Search enables you to search for plates using the Plate ID (barcode).

You are still here

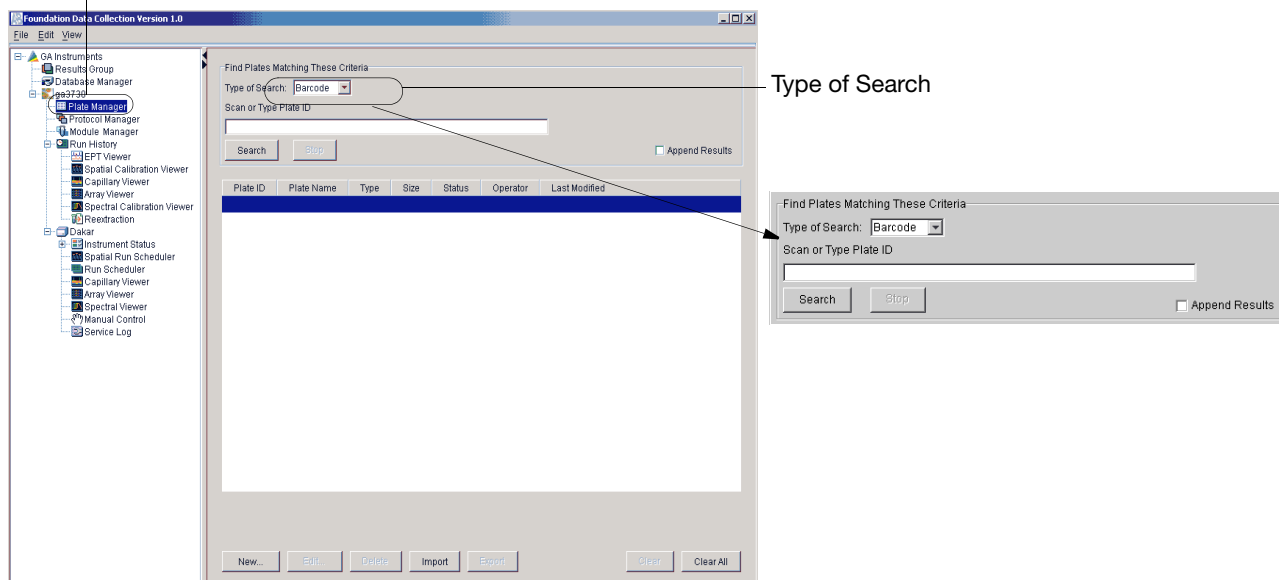

Figure 2-35 Barcode Search Window

The following table lists the elements of the Barcode search window.

Field	Description
Scan or Type Plate ID	Scan (using an external barcode scanner), or type a plate ID (barcode) into the field.
Search button	Starts the search for the plate ID entered in the Plate ID field. Once a match is found, the corresponding plate displays in the Plate List table.
Stop button	Enabled when a search is in progress. Allows you to stop the search.
Append Results	When checked, adds the found plate record to the Plate List table without removing previously searched entries.

Advanced Search Window

Within the Plate Manager window, choose Advanced Search from the Type of Search menu. The advanced search enables you to search for multiple plates simultaneously and by several different Plate Record attributes which are described below.

Toggle here between Barcode and Advanced

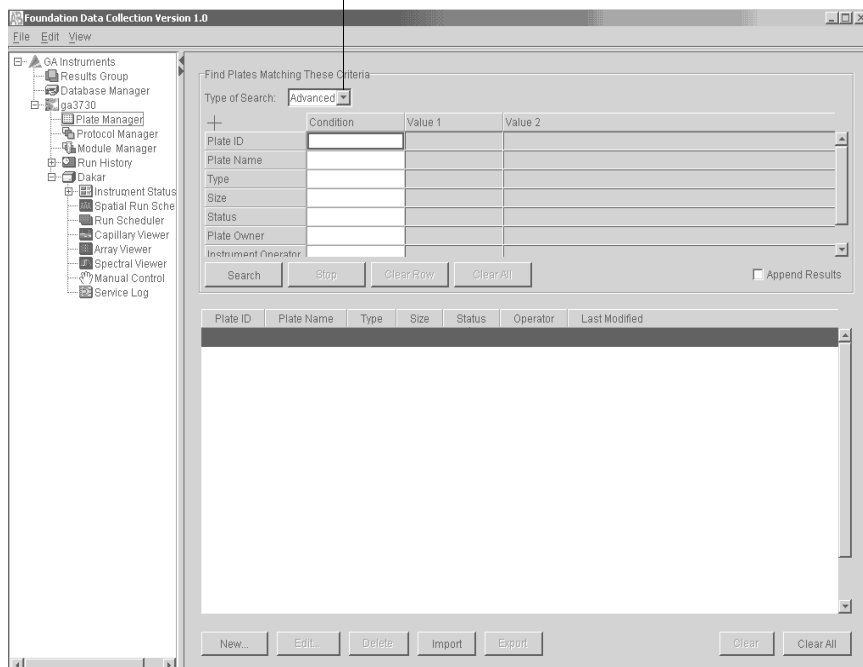

Figure 2-36 Advanced Search Window

The following table describes the columns of the Advanced Search window.

Column	Description
Condition	Defines search conditions for each of the search variables (see Figure 2-37 below).
Value 1	Contains the primary string to be used in the search.
Value 2	Contains a secondary string to be used in a search, such as an ending date. Note: Enabled only when using 'between' as a condition (see Figure 2-38).
Search button	Starts the search. Disabled when a search is in progress.
Stop button	Stops the search. Enabled when a search is in progress.
Clear Row button	Clears the conditions and values from the selected Variable row.
Clear All button	Clears the conditions and values from all of the Variable rows.
Append Results	When checked, adds the found plate to the Plate List table without removing previously searched entries.

Use the drop-down lists to define search conditions for each of the categories (Plate ID, Plate Name, Type, Size, etc.)

Find Plates Matching These Criteria

Type of Search: **Advanced**

Category	Condition	Value 1
Plate ID	Starts With	
Plate Name		
Type	=	
Size	<	
Status	>	
Plate Owner	Not Equal	
Instrument Operator	Contains	
	Between	
	Starts With	

Buttons: Search, Clear Row

Figure 2-37 Defining Search Conditions

Find Plates Matching These Criteria

Type of Search: **Advanced**

Category	Condition	Value 1	Value 2
Plate Name	Not Equal		
Type	Contains	SequencingAnalysis	
Size	Starts With	96-Well	
Status	Starts With	pending	
Plate Owner	=	Mr. Holmes	
Instrument Operator	Contains	Mr. Holmes	
Date Last Modified	Between		

Buttons: Search, Stop, Clear Row, Clear All, Append Results

Figure 2-38 Value 2 column is only enabled when the 'between' condition is used.

Using The Plate List Table

To use the Plate List table:

1. Click a row in the Plate List table to select that Plate Record.
2. Double-click a row to open the Plate Editor for the chosen Plate Record.
3. Click a column header in the Plate List table to sort entries by that column's attributes.
4. Click again to toggle the entries in ascending and descending order. The following table describes the action buttons located in the lower portion of Plate List window.

Plate List Window	
Entry	Function
New button	Opens the New Plate dialog box (See page 2-6).
Open button	Opens the Plate Editor window for the selected plate record (see page 2-8).
Import button	Opens the Import dialog box. Use this to import plate records into the database.
Export button	Opens the Export dialog box. Use this to export plate records to a flat file (transfer) format. Enabled when a plate record is selected.
Delete button	Deletes the selected plate record from the local 3730/3730xl Data Collection database.
Clear button	Clears the selected plate record from the Plate List search results (not from the local 3730/3730xl Data Collection database).
Clear All button.	Clears all plates from the Plate List search results (not from the local 3730/3730xl Data Collection database).

For more information on how to add the selected plate records to a set of scheduled runs, see page 1-36.

3730/3730xl Data Collection and Fragment Analysis

3

In This Chapter	3730/3730xl Data Collection Software and GeneMapper™ Software v3.0	3-2
	Sample Preparation	3-5
	About Plate Records	3-6
	Using the Plate Manager For GeneMapper Software	3-8
	Working With a Results Group	3-13
	Working With Instrument Protocols For Fragment Analysis	3-25
	Using the AutoAnalysis Manager	3-29
	Plate Search	3-35
	Autoanalysis Integration	3-39

3730/3730xl Data Collection Software and GeneMapper™ Software v3.0

- Important Notes**
- A unique name must be assigned to the instrument computer before 3730/3730xl Data Collection software is installed.
 - Do not rename the computer once 3730/3730xl Data Collection software has been installed. Doing so may cause the 3730/3730xl Data Collection software to malfunction.
 - The 3730/3730xl Data Collection software does not allow all types of characters when naming samples, files, etc. Further, you may change what characters are allowed. The following table includes characters that are allowed by default. For more information refer to:

AppliedBiosystems\UDC\DataCollection\Config\UserProperties.txt

Unacceptable Characters

The following table includes characters that are *not* accepted.

Unacceptable Character	Description
'	Accent
&	Ampersand
'	Apostrophe
{ }	Braces
[]	Brackets
^	Caret (circumflex)
\$	Dollar
!	Exclamation
()	Parentheses
+	Plus
;	Semicolon
~	Tilde
V	'v' key

IMPORTANT! If an application, 3730/3730xl Data Collection for example, needs to replace an illegal character in the file name, you should replace it with an *underscore* (_).

Acceptable Characters

The following table includes characters that are allowed.

Acceptable Character	Description
/ \	Forward or backward slash
:	Colon
*	Asterisk
?	Question mark
"	Quotation mark
< >	Inequality signs
	Vertical line
%	Percentage
#	Number sign
	Space

Overview

You may choose to perform autoanalysis of fragment analysis samples by utilizing features of the 3730/3730xl Data Collection and GeneMapper software v3.0.

IMPORTANT! Perform fragment analysis on 48 capillary, 36 cm arrays only.

Autoanalysis

Autoanalysis can only be performed on the same instrument that collected the sample files. If you wish to analyze samples on another computer, you must transfer the files to that location.

Additionally, if a user performs autoanalysis on samples, but wishes to edit/review results on another computer, they will need to transfer the GeneMapper software project, analysis methods, size standards, panel and bin set information to the other GeneMapper software database. There is no easy method for transferring all components of a project from one GeneMapper software database to another. All components need to be exported and imported individually.

When completing the Plate Record, you need to fill in Instrument Protocol information for Data Collection to complete the run. Additionally, when creating a new Results Group for a set of samples to be autoanalyzed, you must check the Do Autoanalysis checkbox.

Manual Analysis

For information on manual analysis, refer to *ABI PRISM GeneMapper Software Version 3.0 User Manual (PN 4335526)*.

About Fragment Analysis and Data Collection

When GeneMapper software v3.0 is installed on a computer that has Applied Biosystems 3730/3730xl DNA Analyzer Data Collection Software, two applications are available through the Results Group Editor (see page 3-13), and the Plate Manager (see page 3-8):

- GeneMapper-Generic
- and,
- GeneMapper<Instrument Name>

GeneMapper Generic

GeneMapper-Generic enables you to generate .fsa files, but not perform autoanalysis. When completing the Sample Sheet, you need to fill in basic information for Data Collection to complete the run; all other GeneMapper software related fields are text entries. This is useful if you are using other software applications for analysis. This is also useful if you choose to analyze your samples in GeneMapper software on another computer, but do not have the same entries in the GeneMapper software database stored on the Data Collection computer. For example, if you have a customized size standard definition on the other GeneMapper software computer, you can type in that size standard name in the size standard text field and it will populate that column in your GeneMapper software project.

GeneMapper <Instrument Name>

GeneMapper<Instrument Name> is for autoanalysis. The Size Standard, Analysis Method, and Panel columns in the Sample Sheet window read directly from the GeneMapper software database. These components must be created in GeneMapper software prior to setting up the sample sheet for a run. There is no way to create a new entry for these columns once inside the Sample Sheet window. If you create a new GeneMapper software component while the Sample Sheet window is open, the columns will not update. The Sample Sheet must be closed and reopened to update the GeneMapper software components. For more information see, “Setting Up a Run for AutoAnalysis” on page 3-29.

Sample Preparation

Supported Dye Sets Applied Biosystems 3730/3730xl Data Collection Software v1.0 supports Dye Set DS-33, and the ABI PRISM® Linkage Mapping Sets v2.5.

The dyes in the collection Dye Set DS-30 are:

- 6-FAM (blue)
- VIC (green)
- NED (yellow)
- BET (red)—optional dye for primer labeling.

Pooling Ratios The fluorescent dyes are detected with different efficiencies. The pooling ratio, or amount of each dye-labeled product added with respect to the other products in the pool, should be adjusted to ensure an appropriate detection of all the loci.

Pooling Ratios for the ABI PRISM® Linkage Mapping Sets For Linkage Mapping Sets v2.5, a ratio of 1:1:1:1 (6-FAM:VIC:NED:PET- labeled products) gives acceptable balance across most loci.

For each Linkage Mapping Set panel, pool 1 µL of each PCR product in a microcentrifuge tube. If necessary, bring the total volume to 10–20 µL with deionized water. Aliquot 10 µL of diluted PCR product for a 96-well, or 5 µL for a 384-well MicroAmp® optical plate(s).

Suggested Loading Volumes



WARNING

CHEMICAL HAZARD. Formamide causes eye, skin, and respiratory tract irritation. It is a possible reproductive and birth defect hazard. Read the MSDS, and follow the handling instructions. Wear appropriate protective eyewear, clothing, and gloves.

Prepare the formamide:size standard mix using:

- 1000 µL of Hi-Di™ Formamide (P/N 4311320) or similar quality formamide
- 50 µL of GeneScan™ 500 LIZ

Note: Use these ratios of pooled PCR products and size standards as a starting point only. Optimize these ratios, as necessary, based on your experimental results.

For loading, mix 0.5 µL of pooled PCR products with 9.5 µL of formamide:size standard mix.

Denaturing Samples

To denature samples:

1. Heat samples at 95 °C for 5 minutes.
2. Place immediately on ice for at least 5 minutes before loading.

About Plate Records

Overview A plate record is similar to a sample sheet or an injection list that you may have used with other ABI PRISM® instruments.

Plate records are data tables in the instrument database that store information about the plates and the samples they contain. Specifically, a plate record contains the following information:

- Plate name, type, and owner
- Position of the sample on the plate (well number)
- Comments about the plate and about individual samples
- Dye set information (in Instrument protocol)
- Name of the run module (run modules specify information about how samples are run) (in Instrument protocol)

When to Create a Plate Record A plate record must be created for each plate of samples for the following types of runs:

- DNA sequencing
- GeneMapper<Instrument Name> or, GeneMapper-Generic
- Spectral calibrations
- Plate records must be created in advance of placing the plates on the instrument.
- Plate records can be created while a run is in progress.

The Applied Biosystems 3730/3730xl DNA Analyzer Data Collection Software contains several new features that are briefly described here and in more detail throughout this section.

Parameters	Description	See Page
Instrument Protocol	Contains everything needed to run the instrument.	3-25
Results Group	Defines the file type, the file name, and file save locations that are linked to sample injections.	3-13
Plate Manager	Stores and organizes plate records which link samples to the Instrument and GeneMapper software settings, and to the Results Group.	3-8

IMPORTANT! In order for data collection and auto-analysis to be successful, each run of samples must have an Instrument Protocol and a Results Group assigned within a plate record.

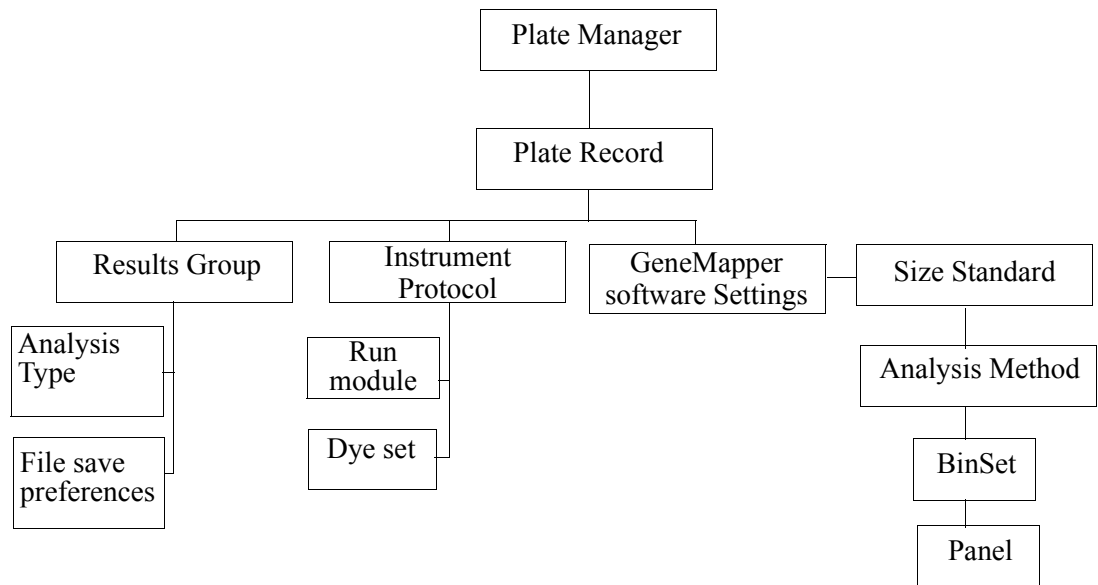

Figure 3-1 Elements of a Plate Record for GeneMapper software

Using the Plate Manager For GeneMapper Software

The Plate Manager allows you to create, edit, and search for plates.

1. Click the Plate Manager  icon in the tree pane.

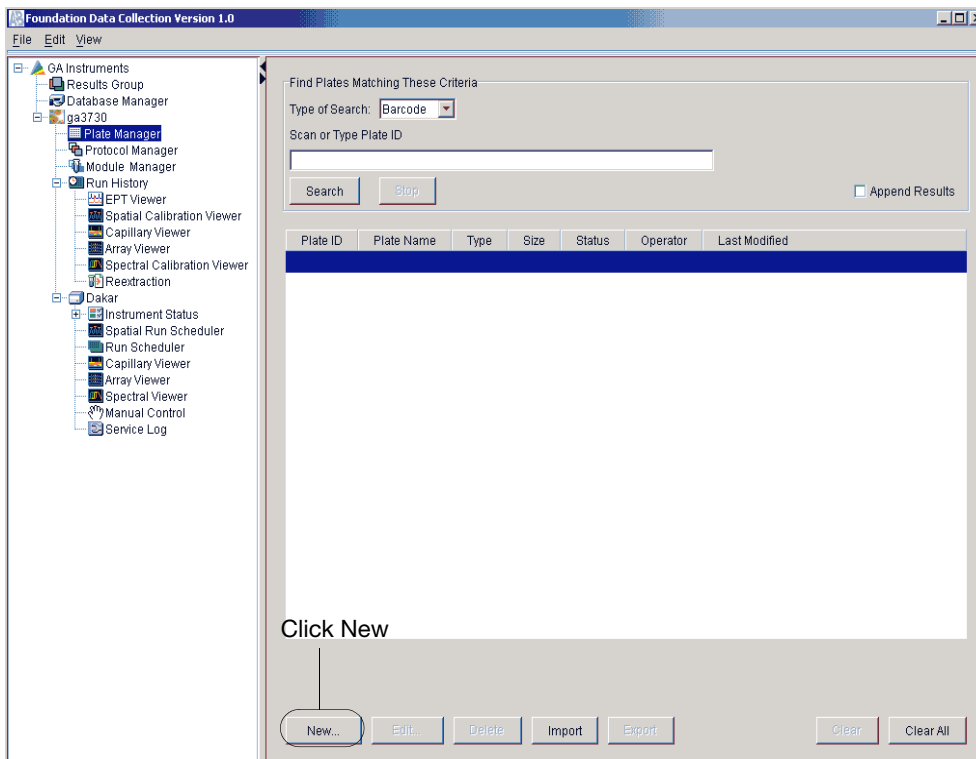

Figure 3-2 Plate Manager Window

2. Click **New** to open the New Plate Dialog box.

Elements of the New Plate Dialog Box

The following table describes the elements of the **New Plate** dialog box that displays when you click New in the **Plate Manager** window.

Note: All fields except Description are required before proceeding.

The screenshot shows the 'New Plate Dialog' window. The fields are as follows:

- ID (Barcode):
- Name:
- Description:
- Application: None (dropdown)
- Plate Type: 96-Well (dropdown)
- Scheduling: 1234 (text input)
- Plate Sealing: None (dropdown)
- Owner Name:
- Operator Name:

Buttons: OK, Cancel

Figure 3-3 96-well plate type selected in New Plate dialog box

The screenshot shows the 'New Plate Dialog' window with the following fields:

- ID (Barcode): test
- Name: test
- Description:
- Application: GeneMapper-Generic (dropdown)
- Plate Type: 384-Well (dropdown)
- Scheduling: 1234 (text input)
- Plate Sealing: Heat Sealing (dropdown)
- Owner Name: user
- Operator Name: user

Buttons: OK, Cancel

A scheduling grid is displayed to the right of the 'Scheduling' field:

	1	2
A	1	3
B	2	4

If you select a 384-well plate type, a scheduling option displays

Figure 3-4 384-well plate type selected in New Plate dialog box

Table 3-1 Elements of the New Plate Dialog Box

Field	Description
ID (Barcode)	Plate barcode or other unique ID
Name	Unique plate name
Description	Plate description (optional)
Application	<p>Sets the type of application for the plate. List contains the supported analysis applications:</p> <ul style="list-style-type: none"> • Spectral Calibration • Sequencing Analysis • GeneMapper<Instrument Name> (autoanalysis) • GeneMapper-Generic (no autoanalysis) <p>Note: What you select here determines what Results Groups you can select in the Plate Editor.</p>
Plate Type	Sets the size of the plate for either 96-well or 384-well.
Plate Sealing	Sets the sealing type of the plate for either Heat Sealing or Septa.
Owner Name	Contains the name of the plate owner
Operator Name	Contains the name of the operator who ran the plate.
OK button	Validates the entries in the fields, creates the new Plate Document, and displays it in the Plate Editor window.
Cancel button	Closes the dialog box without creating a new plate.
Note: The plate (barcode) ID and plate name must be unique to enable database searching for the plate record.	

Note: You must have sufficient database space available to create new protocols within an open plate record. The Database Manager alerts you if there is not enough space. To free up space, see page 5-32.

IMPORTANT! After clicking OK within the Plate Editor, the completed plate record is stored in the Plate Manager database. Once in the Plate Manager database, the plate record can be searched for, edited, exported, or deleted.

However, editing plates during extraction causes extraction results to be overwritten. If, for example, you create a plate with two or more runs and then run the plate. When the first run is extracting, you open the plate editor and make some changes and then save the results. When you then view the run in the re-extraction panel, some of the Analysis results may be blank, having been overwritten by the Plate Editor.

GeneMapper Software Plate Editor

The Plate Editor displays an empty plate record for the selected application.

Well	Sample Name	Comment	Results Group	Sample Type	Size Standard	Panel
A01						
B01						
C01						
D01						
E01						
F01						
G01						
H01						
A02						
B02						
C02						
D02						
E02						
F02						
G02						
H02						
A03						
B03						
C03						
D03						
E03						
F03						
G03						
H03						
A04						
B04						
C04						

Figure 3-5 Elements of the GeneMapper software Plate Editor

The following table describes the columns inserted in a Plate Record for a GeneMapper™ software run.

Table 3-2 Columns in the GeneMapper software Plate Record

Column	Description
Sample Name	Name of the sample (required)
Comment	Comments for the sample (optional)
Results Group	You must have a Results Group selected for each sample entered in the Sample Name column. This becomes the GeneMapper software project name.
Sample Type	<ul style="list-style-type: none"> GeneMapper-Generic (optional) : Manually enter sample type in the text field* GeneMapper-<Instrument Name>: Select a saved sample type from the drop-down list
Size Standard IMPORTANT! For GeneMapper <Instrument Name> ONLY: Size Standard, Panel, and Analysis Method must be created in GeneMapper software before creating a new plate	<ul style="list-style-type: none"> GeneMapper-Generic (optional) : Manually enter size standards in the text field* GeneMapper<Instrument Name>: Select a saved size standard from the drop-down list
Panel IMPORTANT! For GeneMapper <Instrument Name> ONLY: Size Standard, Panel, and Analysis Method must be created in GeneMapper software before creating a new plate	<ul style="list-style-type: none"> GeneMapper-Generic (optional) : Manually enter panels in the text field* GeneMapper<Instrument Name>: Select a saved panel from the drop-down list
Analysis Method IMPORTANT! For GeneMapper <Instrument Name> ONLY: Size Standard, Panel, and Analysis Method must be created in GeneMapper software before creating a new plate	<ul style="list-style-type: none"> GeneMapper-Generic (optional) : Manually enter analysis methods in the text field* GeneMapper<Instrument Name>: Select a saved analysis method from the drop-down list
3 User-defined columns	Optional text entries
Instrument Protocol	<ul style="list-style-type: none"> New: Opens the Protocol Editor dialog box. An alert displays if there is not sufficient space. Edit: Opens the Protocol Editor dialog box for the Instrument Protocol listed in the cell. None: Sets the cell to have no selected protocol. List of Instrument Protocols: In alpha-numeric order. <p>Note: You must have an Instrument Protocol selected for each sample entered in the Sample Name column.</p>

For more information about GeneMapper set up, refer to the *ABI PRISM GeneMapper Software v3.0 User Guide*.

* Text fields are case insensitive; preceding and trailing spaces are ignored.

Note: We recommend that you select ‘Read from Sample,’ ‘Read from Data Collection’ for all items in the Add Samples tab of the GeneMapper software Options dialog box. If other settings are applied, they will overwrite whatever is has been chosen in the Sample Sheet.

Working With a Results Group

Overview A Results Group is a way to organize samples and certain user settings under a single name. It is called a Results Group because it is used to analyze, name, sort, and deliver samples that result from a run.

You can create a Results Group two different ways:

- Within the Plate Record
- or,
- Within the left navigation pane under GA Instruments.

Creating a Results Group

To create a Results Group:

1. Click:
 - a. The Results Group  icon to display the Results Group Editor.
 - or,
 - b. In the Plate Record, click **New** under the Results Group column.

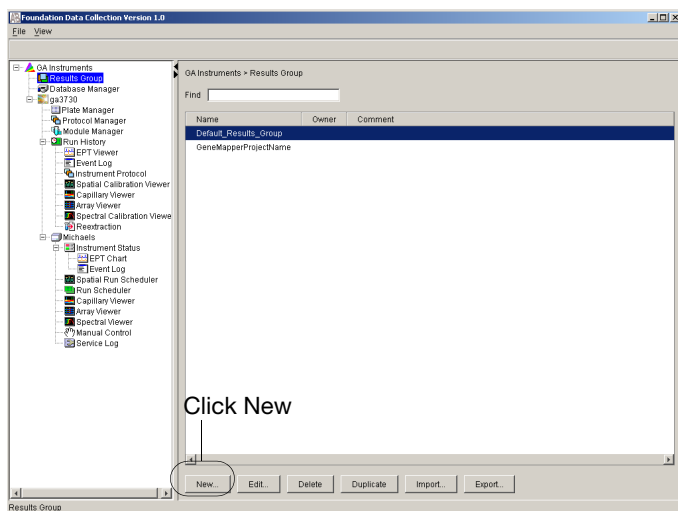

Figure 3-6 Create a Results Group from within the Group Editor Window

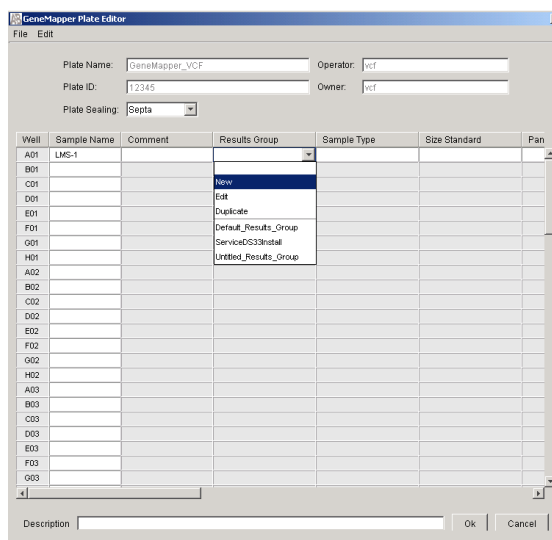

Figure 3-7 Create a Results Group in the Plate Record

2. Click **New** or highlight an existing group and click **Edit**.
The Results Group Editor window displays.

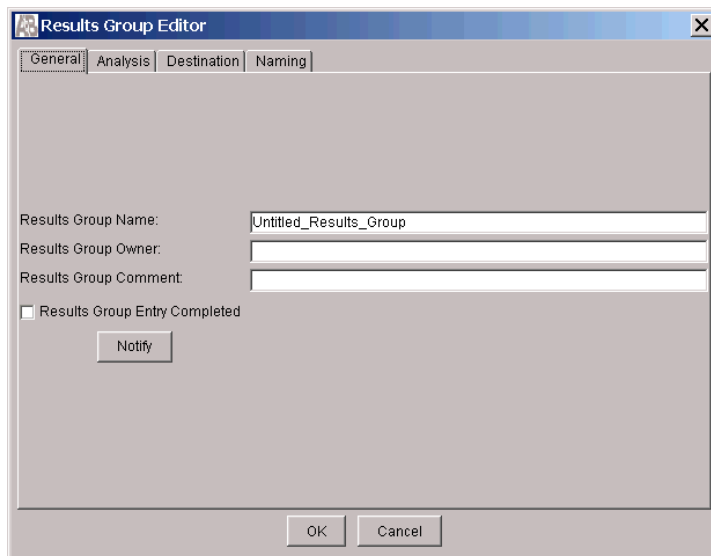

Figure 3-8 Results Group Editor

Results Group Editor Tabs

Each tab in the Results Group Editor window is described below.

General Tab

To complete the General tab:

1. Type a Results Group Name. The name can be used in naming and sorting sample files. It must be unique (see 3-25 for a list of accepted characters).
The Results Group name will be your GeneMapper software Project name.
2. Type a Results Group Owner. The owner name can be used in naming and sorting sample files.
3. Type a Results Group Comment (optional).

4. Select Results Group Entry Completed check box.

IMPORTANT! You must check **Select Results Group Entry Completed** for the message to be sent to the AutoAnalysis Manager.

Note: Click **Notify** only if you forget to select **Results Group Entry Completed**, or **Do Auto Analysis** on the Analysis tab, after the run is completed you can update the Results Group by selecting the boxes and then use Notify to send the complete project message to the AutoAnalysis Manager.

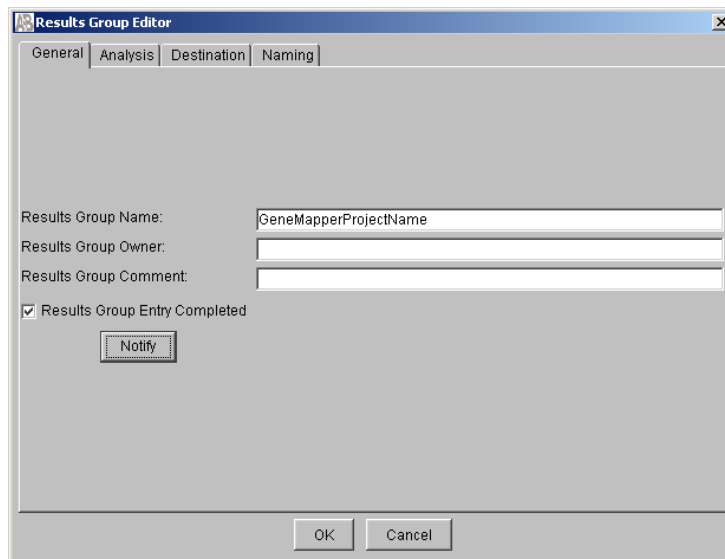

Figure 3-9 General tab in the Results Group Editor Window

Analysis Tab To complete the Analysis tab:

1. Click the Analysis Type and then select one of the following:
 - <None>
 - GeneMapper-Generic
 - GeneMapper<Instrument Name>

IMPORTANT! Steps 2, 3, and 4 below apply only to GeneMapper<Instrument Name> (not GeneMapper-Generic).

2. Select the **Do Autoanalysis** check box if you want to see the analyzed data in the Run folder.
3. Type the login ID.
4. Type the login password.

The login ID and password relate to the GeneMapper software UserName and Password. These items can only be created through the GeneMapper software **Options Users** tab.

IMPORTANT! From the **Analysis Type** list, you must chose either GeneMapper<Instrument Name>, or GeneMapper-Generic.

If You Select...	Then...
GeneMapper<Instrument Name>	Autoanalysis of completed runs is enabled
GeneMapper-Generic	Autoanalysis is not enabled and only .fsa files are generated

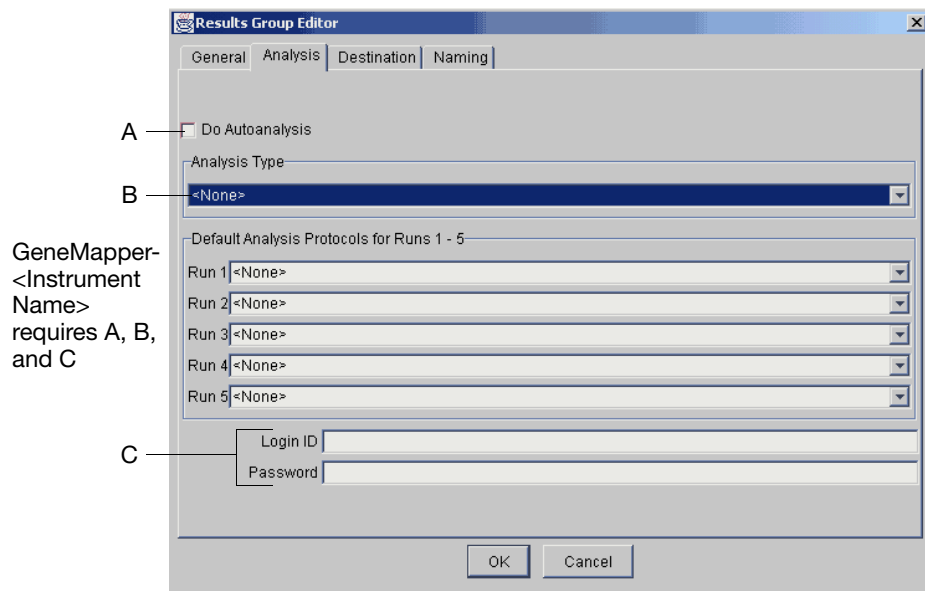

Figure 3-10 Analysis tab in the Results Group Editor Window

- Destination Tab**
- The Location field shows where the sample files are to be placed during extraction. The location can be anywhere on the same computer or on a different computer that is locally accessible.
 - The Location path name is the default path to saved sample files location.

To save to a location other than the default location:

1. Click **Use Custom Location** and then click **Browse** to navigate to a different save location.

IMPORTANT! The custom location you designate must lead to a target disk with a mapped drive where samples will not be moved about. If they are moved after analysis, GeneMapper software will not be able to locate them for the project.

2. Click **Test** to test the Location path name connection:
 - a. If it passes, a message box displays, “Path Name test successful.”
 - b. If it fails, an error box displays, “Could not make the connection. Please check that the Path Name is correct.” Click and retry to establish a connection.

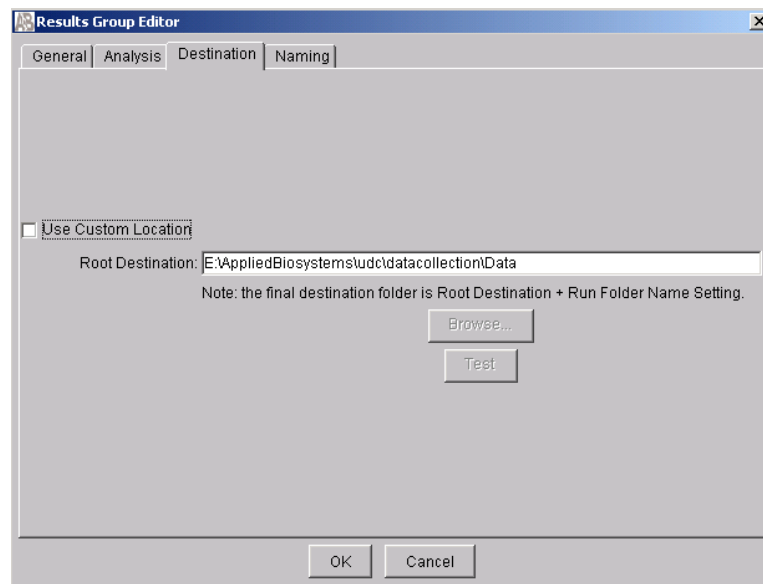

Figure 3-11 Destination tab in the Results Group Editor Window

Naming tab Use the Naming tab to customize sample file and run folder names. See page 3-2 for accepted characters. We recommend that Run Name be used for Run Folder Name Format.

Note: Sample name, run folder name, and path name, *combined*, can total no more than 250 characters.

The elements of the Naming tab are discussed in the following sections. See page 3-2 for acceptable characters.

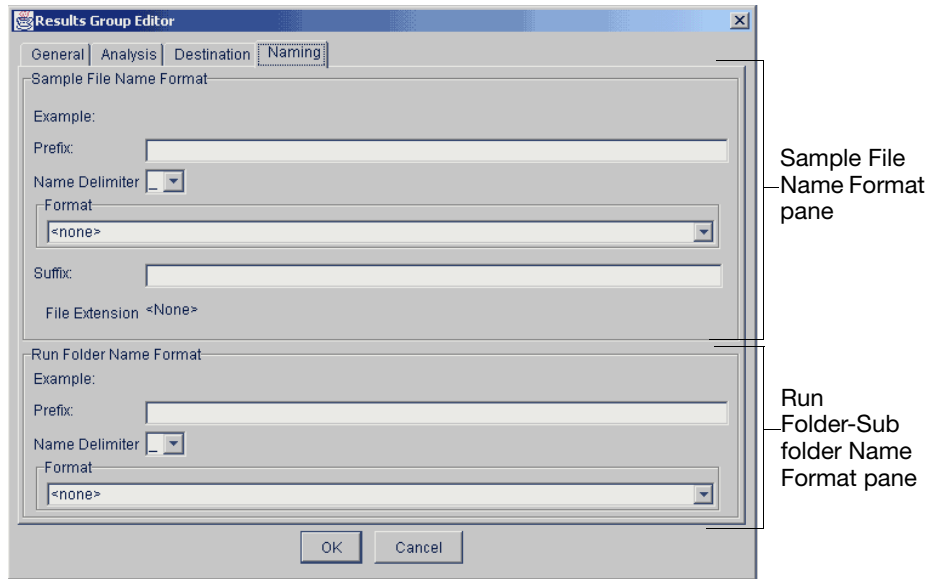

Figure 3-12 Naming tab in the Results Group Editor Window

Sample File Name Format Pane

Following the procedure below to complete the Sample File Name Format pane.

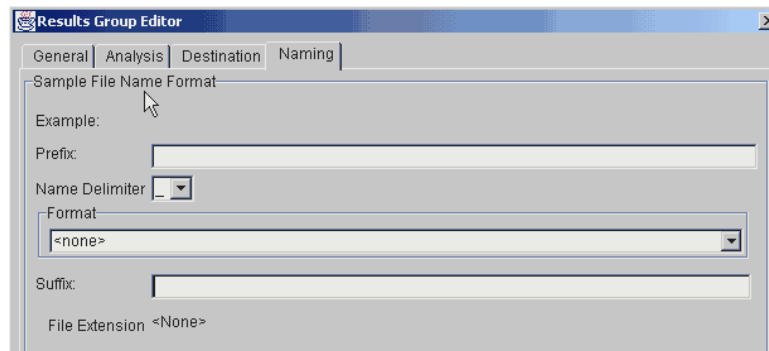

Figure 3-13 Sample File Name Format Pane

1. Click the **Prefix** box (optional) to type a prefix for the file name. All that you type here is shown in the Example line (see figures 3-14 and 3-15).

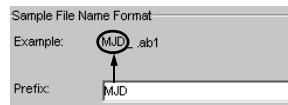

Figure 3-14 Prefix Box

2. Click the **Name Delimiter** list to set the delimiter for the file name. The symbol you select separates the elements in the file name. Only one delimiter symbol may be chosen.

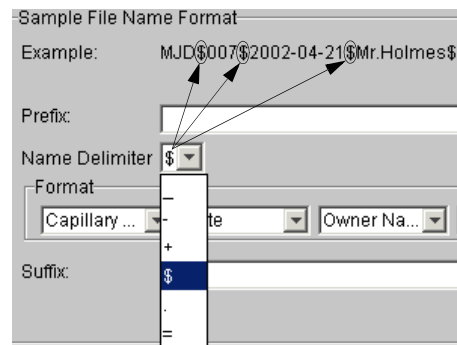

Figure 3-15 Name Delimiter List

3. Click the **Format** list and then select the components that you want in the sample name. Generally, all the samples from a single run are placed in the same run or results folder, so the name of every sample from a single run should be different. Most of the file naming options are not different between samples, so you need to take care to select at least one of the options that make the sample names unique within a run .

If a unique identifier is not included in the name, a warning message displays. However, the Results Group makes the file name unique. As you select the elements for the file name, they are reflected in the Example line (see figure 3-16).

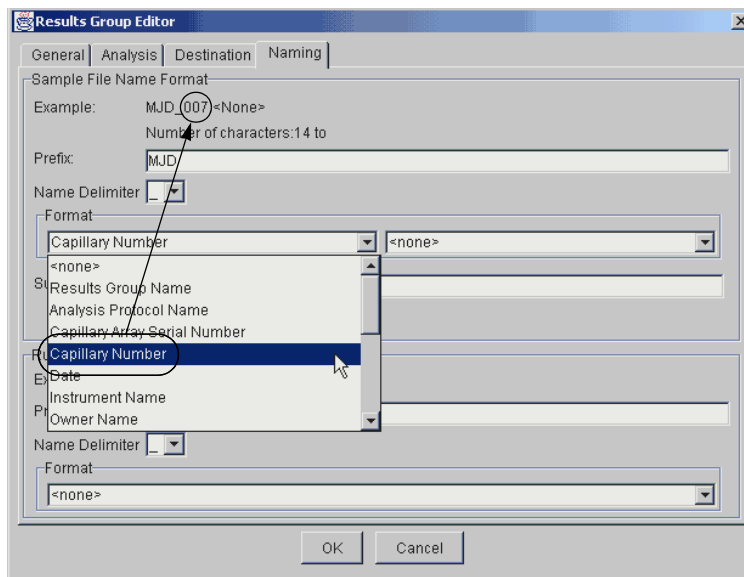

Figure 3-16 Format List The Example field shows an updated example of all the elements you have added to make a unique sample file name

As you continue to select elements for the file name, additional elements display (see figures 3-17 and 3-18).

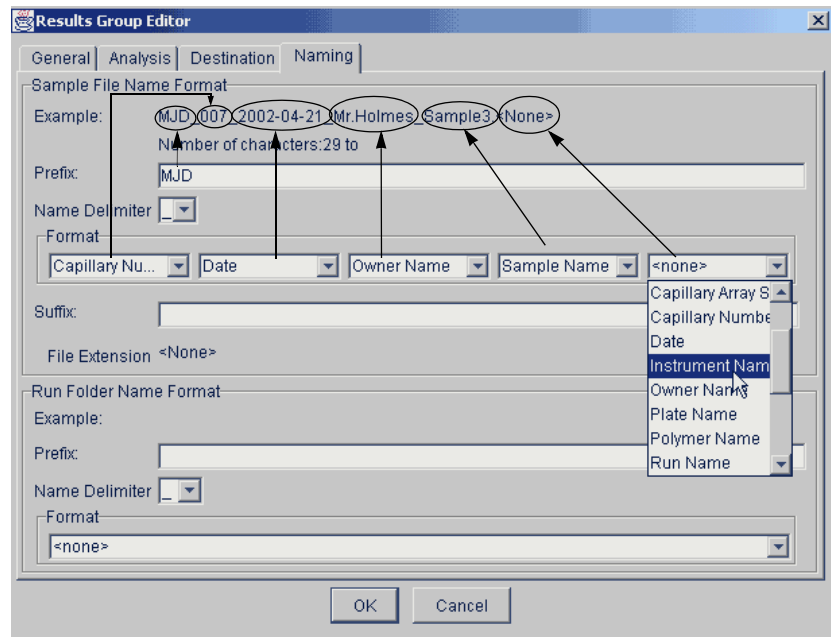

Figure 3-17 As you select more elements for the file name, additional elements display...

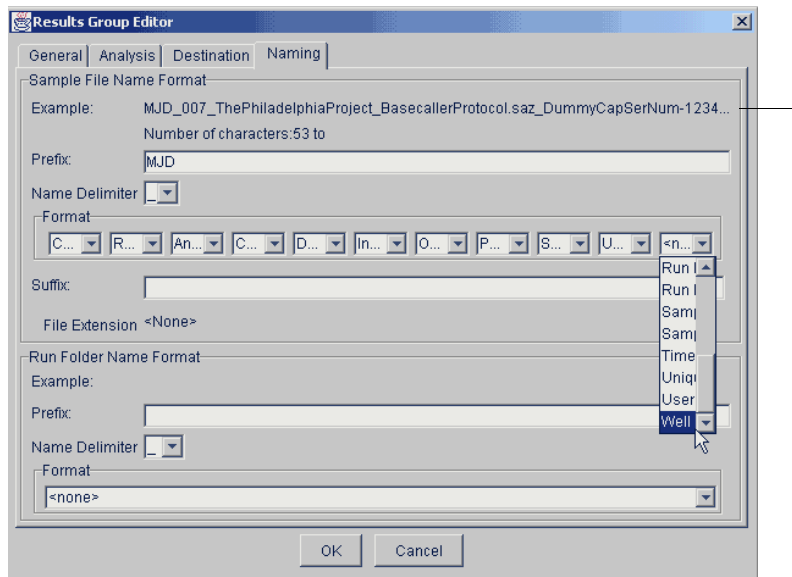

Figure 3-18 ...and although the names of the Format elements truncate, the Example field is still visible and displays the elements you have chosen.

4. Click the **Suffix** box (optional) and type the suffix for the file name.

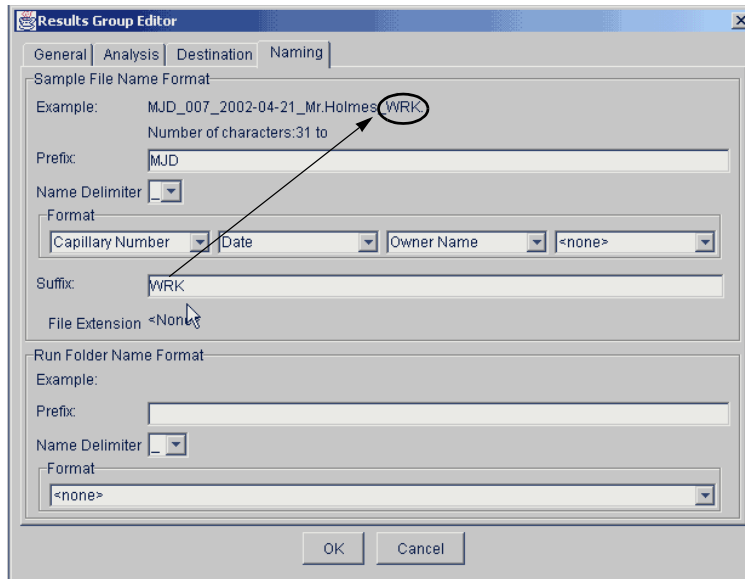

Figure 3-19 Type a suffix and it displays at the end of the file name

The File Extension field displays the file extension used for the Analysis Type specified on the **Analysis** tab. For example, sequencing analysis generates files with an .ab1 extension.

Run Folder/Sub-Folder Name Format Pane

Follow the same steps described above for the Sample File Name Format pane to change the sub-folder names with the run folder.

IMPORTANT! You must select at least one Format element for the Sample file and the Run folder names in order to proceed within the Results Group.

About Format Elements (Unique Identifiers)

While you may select a minimum of just one Format element for the Sample file and Run folder names in order to proceed, selecting just the minimum may not provide enough information for you to identify the file later.

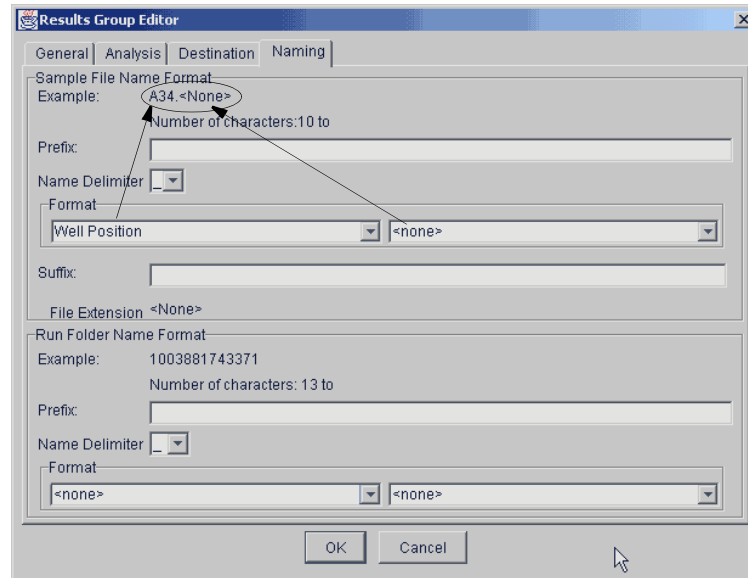

Although acceptable, the 'A34' sample file name above (well position) may not be helpful when trying to locate and identify the file later.

Figure 3-20 Unique Identifiers

If you enter information from the Format lists that is not unique, a warning displays below the Example line (see graphic below). You must also include a unique element that is not the same value used in the Sample file and Run folder names from the Format lists.

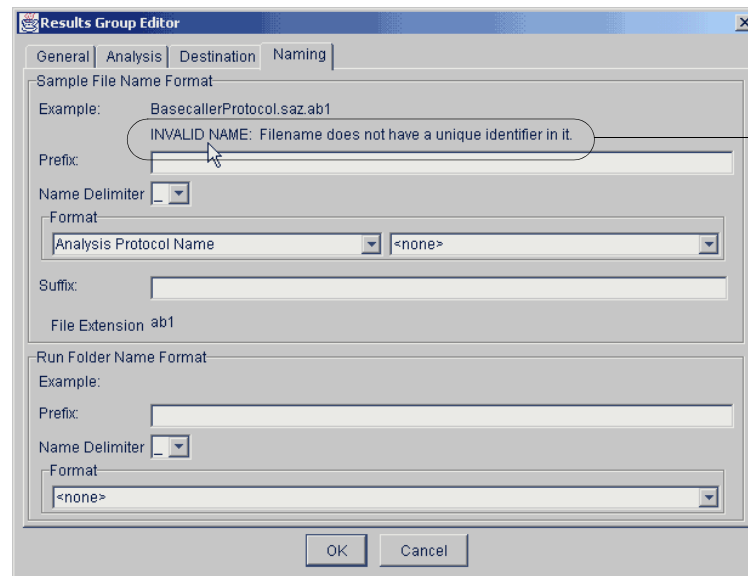

Warning indicates that the Sample file name does not have a unique identifier.

Figure 3-21 Invalid Name warning

In order to proceed within the Results Group Editor window, simply select an element that distinguishes one file from another (for example, the capillary number is unique while the instrument name is not)

Importing and Exporting a Results Group

Results Groups can be imported from, or exported to, tab-delimited text files. This allows easy sharing of identical Results Groups between instruments.

To import a Results Group:

1. Click **Import**.
A standard file dialog box displays.
2. Navigate to the file you want to import.
Note: File type should be .txt (text).
3. Click **Open**.

To export a Results Group:

1. Click the Results Group to select it.
2. Click **Export**.
A standard file dialog box displays.
3. Enter a filename.
4. Navigate to the location where you want to save the exported file.
5. Click **Save**.
Note: If there is a name conflict with a Results Group that already exists, the Results groups can be duplicated in order to copy settings into a similar Results Group without the risk of user error when copying it manually.

To Duplicate a Results Group:

1. Click the Results Group to select it.
2. Click **Duplicate**.
When you import or duplicate a Results Group, you are asked to type a name for the new Results Group and for the analysis application type.

Working With Instrument Protocols For Fragment Analysis

Important Information

IMPORTANT! You must perform a spatial and a spectral calibration run before a GeneMapper<Instrument Name> or, GeneMapper-Generic run can be successfully processed. Also, you must set up a protocol for each run.

The Applied Biosystems 3730/3730xl DNA Analyzer Data Collection Software contains several new features that are briefly described here and in more detail throughout this section.

IMPORTANT! In order for data collection and auto-analysis to be successful, each run of samples must have an Instrument Protocol and a Results Group assigned within a plate record.

Creating an Instrument Protocol

You can create an Instrument Protocol two different ways:

- Within the Plate Record
- or,
- Within the Protocol Manager.

To create an instrument protocol:

1. Click:
 - a. The Protocol Manager icon  to display the Protocol Manager window.
 - or,
 - b. In the Plate Record, click **New** under the Instrument Protocol column.

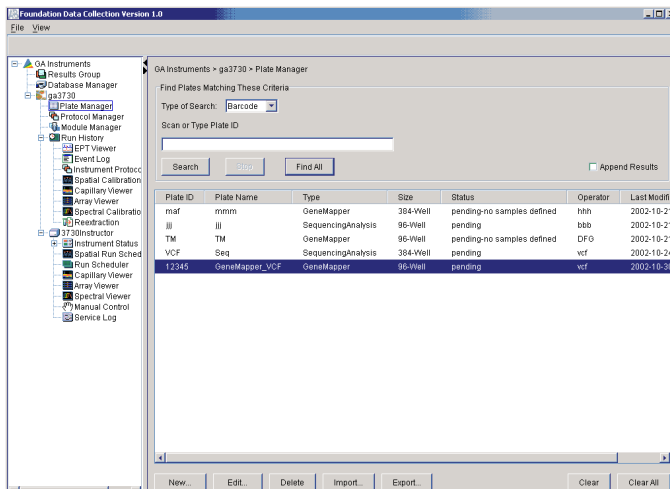

Figure 3-22 Creating an Instrument Protocol in the Protocol Manager window

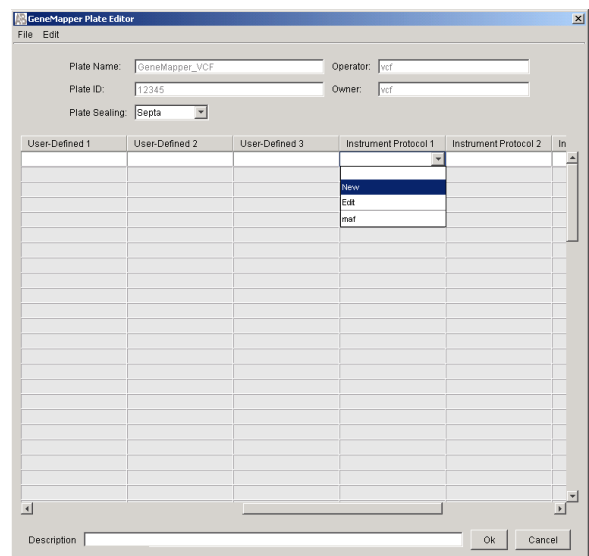

Figure 3-23 Create an Instrument Protocol in the Plate Editor

2. Select **New** in the Instrument Protocols section.
This opens the Protocol Editor window.

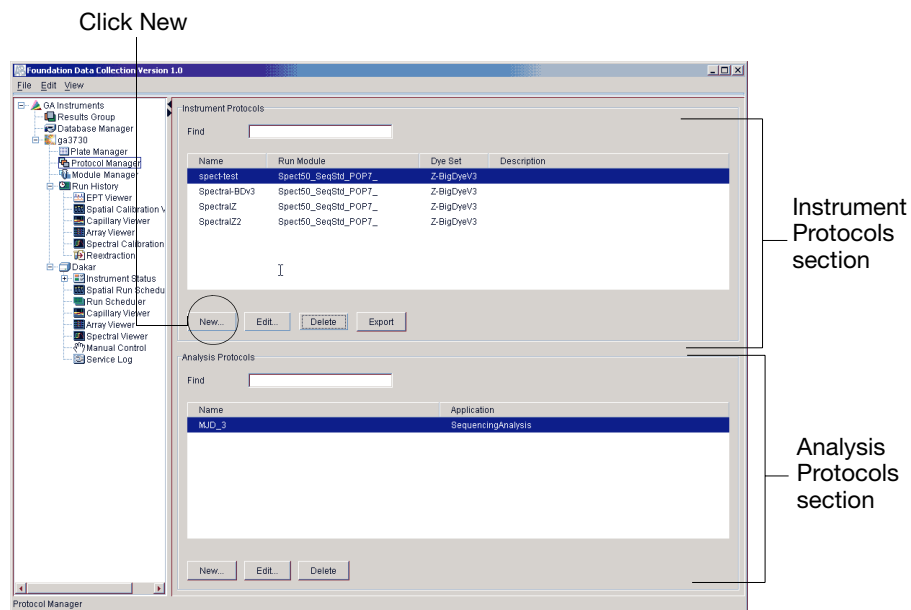

Figure 3-24 Opening the Protocol Editor Window

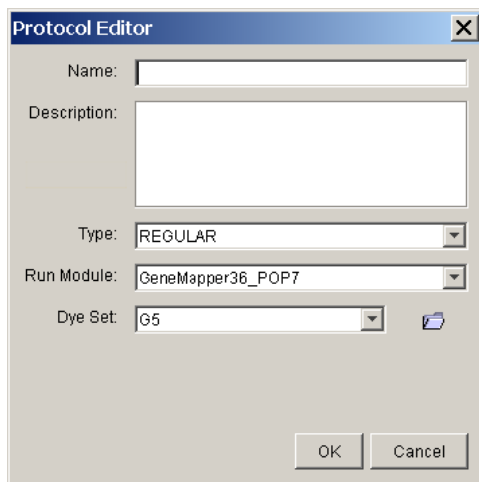

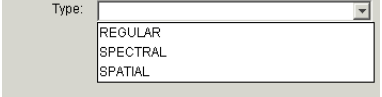
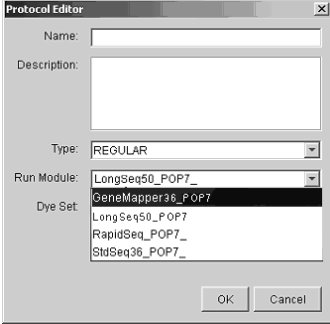
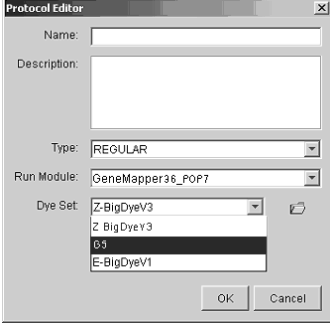

Figure 3-25 Protocol Editor window

Using the Protocol Editor Window

Use the table below to complete the Protocol Editor window.

Table 3-3 Elements of the Protocol Editor window

Text Fields and Menu Choices	Action
<p>Name</p> 	<p>Type the name of the protocol (required).</p>
<p>Description</p> 	<p>Type any descriptions that will help identify the protocol later (optional).</p>
<p>Type</p> 	<p>Select the appropriate run type from the Type list.</p> <p>Note: Select Regular for:</p> <ul style="list-style-type: none"> • Sequencing • GeneMapper<Instrument Name> • GeneMapper-Generic
<p>Run Module</p> 	<p>Select the appropriate run module from the Run Module list. See table 3-4.</p>
<p>Dye Set</p> 	<p>Select the appropriate dye set from the Dye Set list. See table 3-5.</p>

Select the run module from the table below.

Table 3-4 Run Module

Analysis Type	Capillary Array Length	Run Module
Fragment analysis	36 cm	GeneMapper36_POP7

Select the dye set from the table below.

Table 3-5 Dye Set

Analysis Type	Capillary Array Length	Dye Set
Fragment analysis	36 cm	G5

Importing an Instrument Protocol

To import an instrument protocol:

1. Click **Import** in the Instrument Protocols pane of the Protocol Editor window.

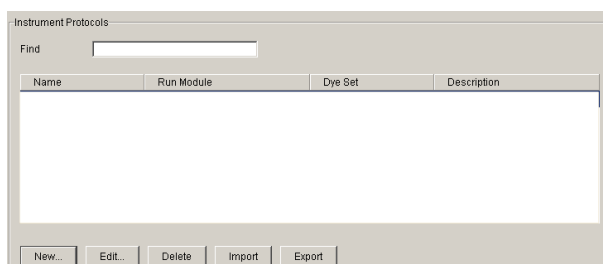

Figure 3-26 Instrument Protocol pane

2. Navigate to the protocol you want to import.

Note: Import file type is .txt (text).

3. Double-click the protocol to import it.

The imported file is displayed as the top row in the Instrument Protocol pane.

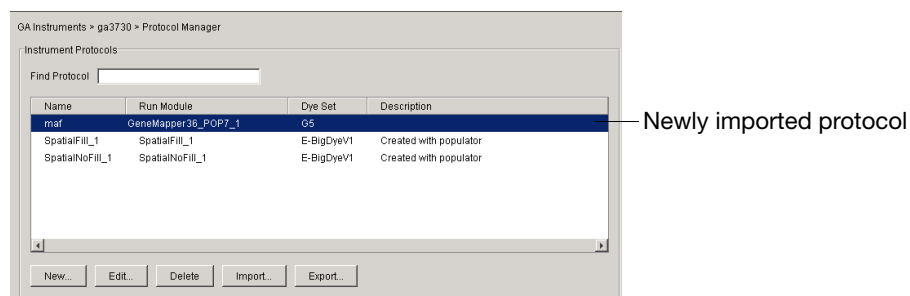
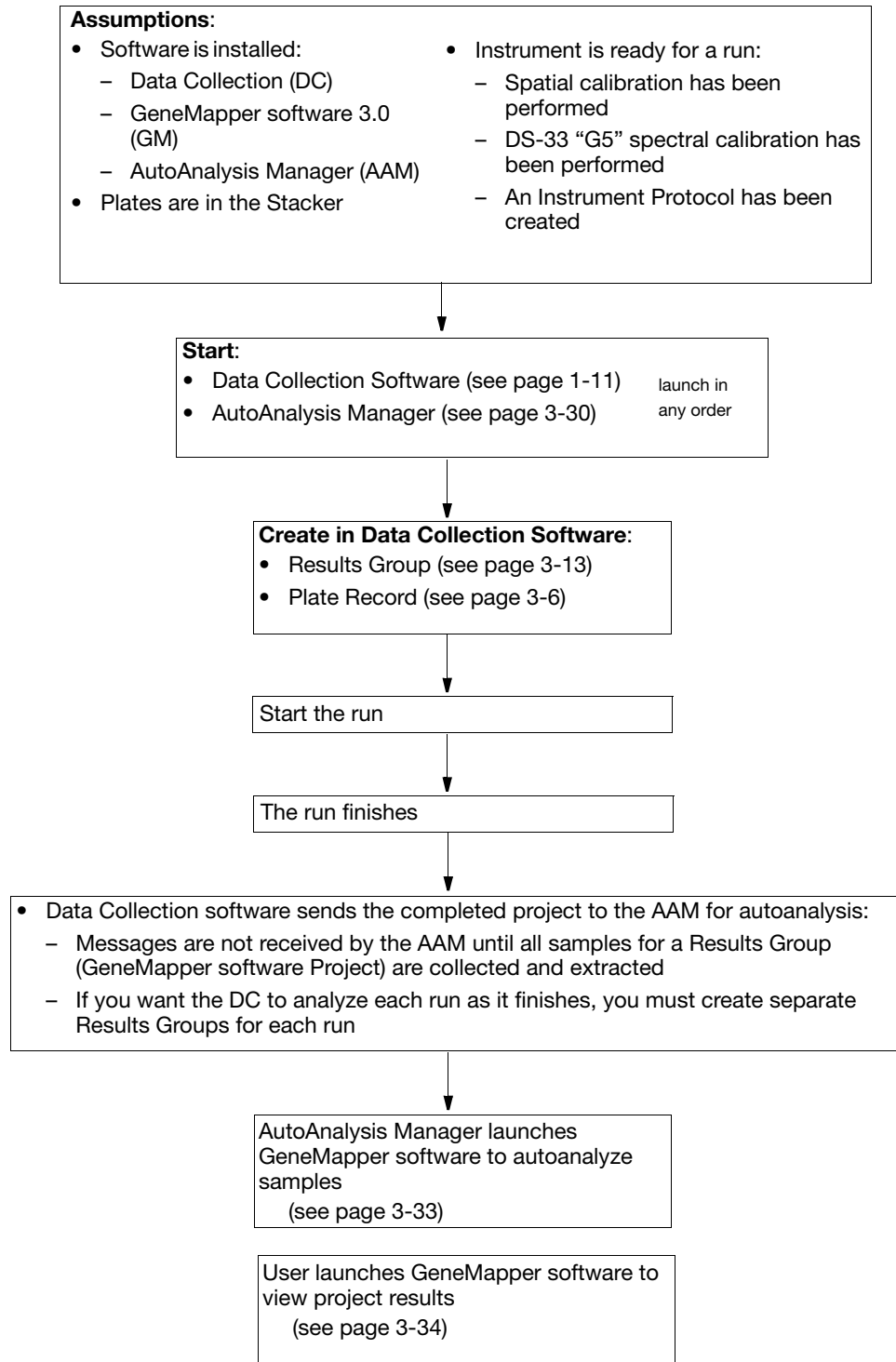

Figure 3-27 Instrument Protocol pane

4. Select **OK** in the Protocol Editor when you have finished creating an Instrument Protocol.

Using the AutoAnalysis Manager

Setting Up a Run for AutoAnalysis Flowchart



Starting the AutoAnalysis Manager (AAM)

Note: The Data Collection Messaging Service must be running in order for analysis messages to be received by the AutoAnalysis Manager.

To start the AutoAnalysis Manager:

1. Click **Start > Programs > Applied Biosystems > Auto Analysis Manager > Auto Analysis Manager v1.0.**

Note: AutoAnalysis Manager does not start automatically. AutoAnalysis Manager must be open to receive messages from 3730/3730xl Data Collection for autoanalysis in GeneMapper software.

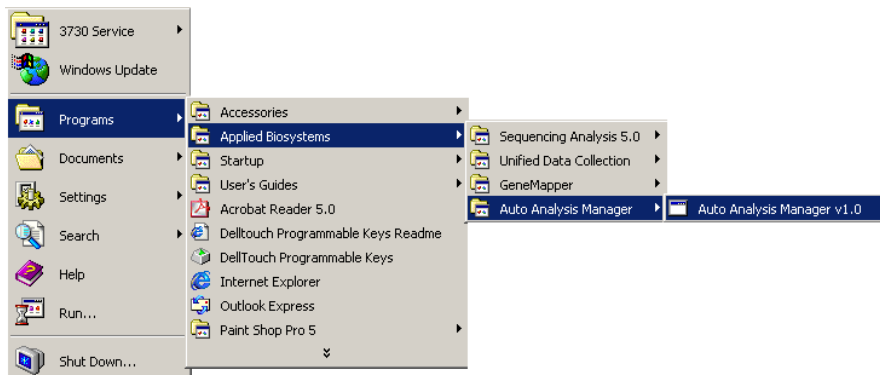

Figure 3-28 Starting the Auto Analysis Manager

The AutoAnalysis Manager window displays.

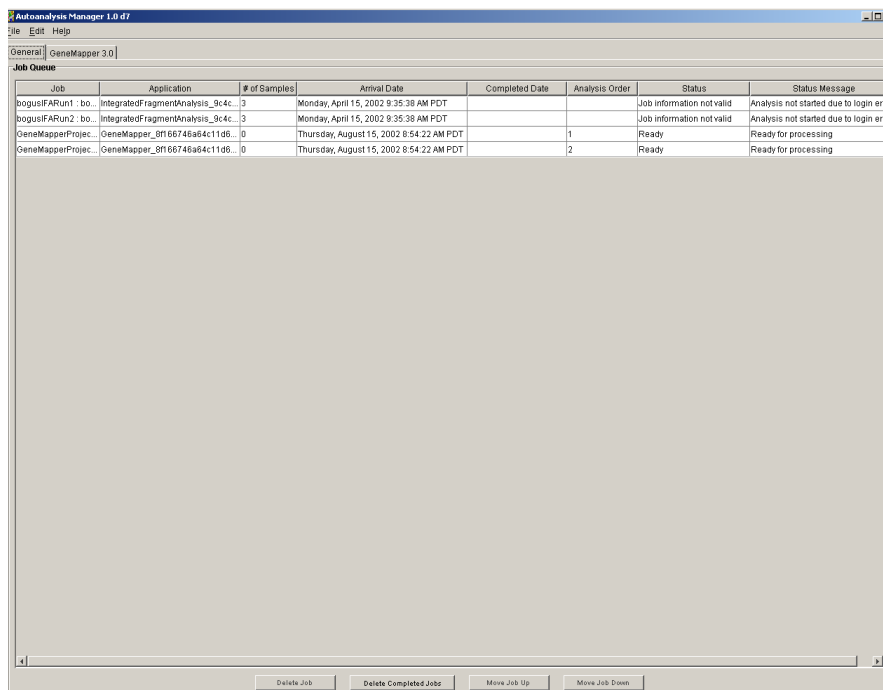

Figure 3-29 General Tab in the AutoAnalysis Manager Window

2. Select either the **General** tab or the **GeneMapper 3.0** tab.

Editing Properties Under the General Tab

The editing buttons are described below.

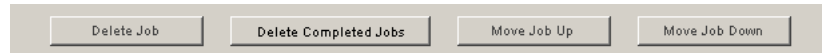

Figure 3-30 Editing buttons under the General tab

Button	Function
Delete Job	Deletes an individual job/project from the AutoAnalysis Manager list. Does not delete sample files or GeneMapper software project.
Delete Completed Jobs	Deletes all completed jobs/projects from the AutoAnalysis Manager list. Only successful jobs are deleted. Does not delete sample files or GeneMapper software projects.
Move Job Up	The active job/project is always given a queue number of 1. Once job 1 is finished analyzing, job 2 becomes job 1 and all other numbers are changed accordingly. Use the Move Up/Down buttons if you want to rearrange the analysis order.
Move Job Down	

Scheduling and Editing Properties Under the GeneMapper 3.0 Tab

Selecting the **GeneMapper 3.0** tab changes the elements of the AutoAnalysis Manager window.

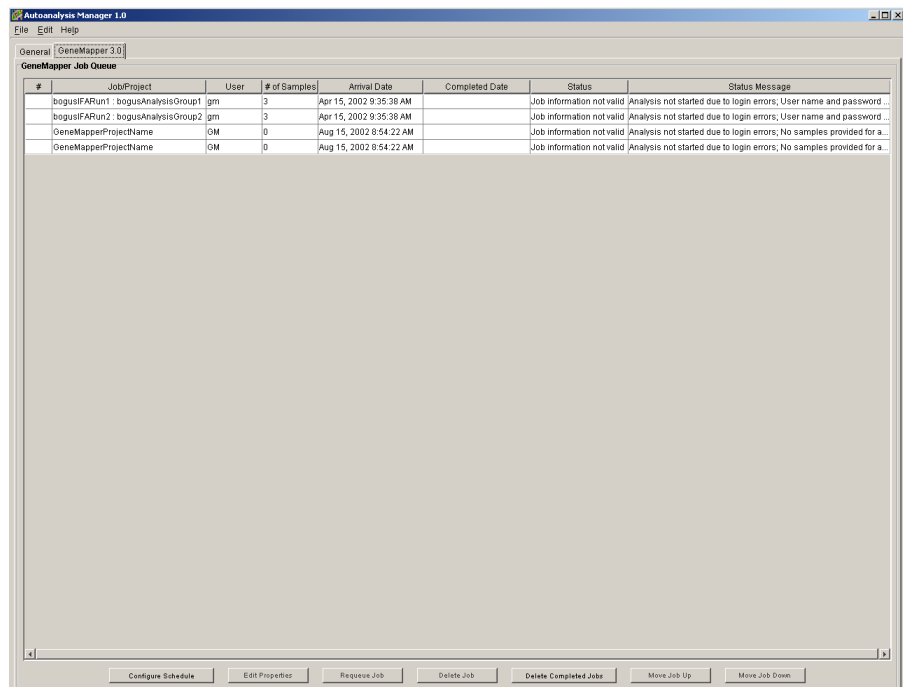
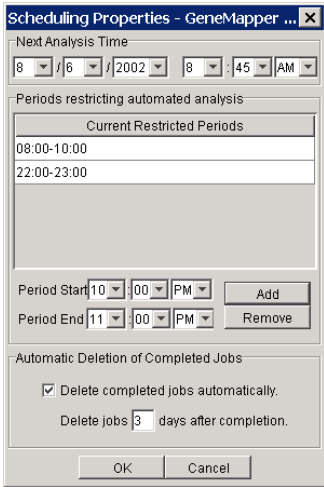

Figure 3-31 Editing buttons under the GeneMapper 3.0 tab

The editing buttons are described below.



Figure 3-32 Editing Buttons

Button	Description
<ul style="list-style-type: none"> • Configure Schedule Select this button and the following screen displays: 	<ul style="list-style-type: none"> • Next Analysis Time: Enables you to set a start time for autoanalysis. Before this time arrives, no autoanalysis of projects will occur. • Periods restricting automated analysis: Enables you to set times during which autoanalysis will not occur. Useful if you know that you are going to be reviewing data during a certain time period and don't want to be bothered by the "Runs ready for processing" dialog box. Runs build up in the queue until the restricting time period is over, then runs will be autoanalyzed. • Automatic Deletion of Completed Jobs: Enables you to set the software to automatically delete successfully completed jobs. Jobs that failed or have not been analyzed will not be deleted. Only the AutoAnalysis Manager job is deleted, sample files and GeneMapper software projects are not.
<ul style="list-style-type: none"> • Edit Properties 	<p>Enables you to change the following settings:</p> <ul style="list-style-type: none"> • Job/Project Name • Username: GeneMapper software UserName • Password: Matching password for GeneMapper software UserName • Queue position: Enter a new queue position number for the project
<ul style="list-style-type: none"> • Requeue Job 	<ul style="list-style-type: none"> • Samples that need to be autoanalyzed have queue numbers listed in the # column. • Samples that are already analyzed or failed, have a blank cell in the # column. <p>To resubmit a job for autoanalysis, use the Requeue Job button to assign a queue number to that job.</p>
<ul style="list-style-type: none"> • Delete Job 	<ul style="list-style-type: none"> • Deletes an individual job/project from the AutoAnalysis Manager list. • Does not delete sample files or GeneMapper software project.

Button	Description
<ul style="list-style-type: none"> Delete Completed Jobs 	<ul style="list-style-type: none"> Deletes all completed jobs/projects from the AutoAnalysis Manager list. Only successful jobs are deleted. Does not delete sample files or GeneMapper software projects.
<ul style="list-style-type: none"> Move Job Up Move Job Down 	<p>The active job/project is always given a queue number of 1. Once job 1 is finished analyzing, job 2 becomes job 1 and all other numbers are changed accordingly. Use the Move Up/Down buttons if you want to rearrange the analysis order.</p>

Autoanalyzing Samples

Once an internal message from the instrument is received by the AutoAnalysis Manager, it launches GeneMapper software to autoanalyze the samples. GeneMapper software must be closed in order for autoanalysis to begin.

If GeneMapper software is open, a dialog box message displays asking if you want to close GeneMapper software in order to process the new runs. Do one of the following:

If You Select...	Then...
Yes	Any pending changes to the current project are saved, GeneMapper software closes and the AutoAnalysis Manager takes over.
No	The runs continue to collect and queue in the AutoAnalysis Manager until GeneMapper software is closed.

The message dialog box has a timer so that if you leave GeneMapper software on but are not using it, once time expires, any pending changes to the current project are saved, GeneMapper software closes, and AutoAnalysis Manager takes over.

GeneMapper software automatically closes after a project has been autoanalyzed. If more runs are in the AutoAnalysis Manager queue, the next project then gets processed.

User Control

The project being analyzed in GeneMapper software is visible to you as it occurs.

You can stop analysis of the samples and gain control of GeneMapper software by pressing the **Stop** button on the lower right corner of the GeneMapper software project window at any time. You can then interact with GeneMapper software. If there are other runs waiting to be processed, you are prompted as described above.

Launching GeneMapper Software to Review Project Results

Launch GeneMapper software to review project results:

- AutoAnalysis Manager displays status messages for all projects in the queue
- Once a project is analyzed, you can open GeneMapper software and select a project from the **File> Open Project** command in the GeneMapper software Project window.
- The GeneMapper software Options item “Open previous project” will only open the last project analyzed by a user and does not work for projects analyzed by the AutoAnalysis Manager

For more information about GeneMapper software, refer to the *ABI PRISM GeneMapper Software v3.0 User Guide*.

Plate Search

Barcode or Advanced Plate Search

Within the Plate Manager, you may search for plates in the **Type of Search** list by clicking either **Barcode** or **Advanced**. A different window displays for each choice. Both are described below.

Barcode Search Window

The Barcode Search enables you to search for plates using the Plate ID (barcode).

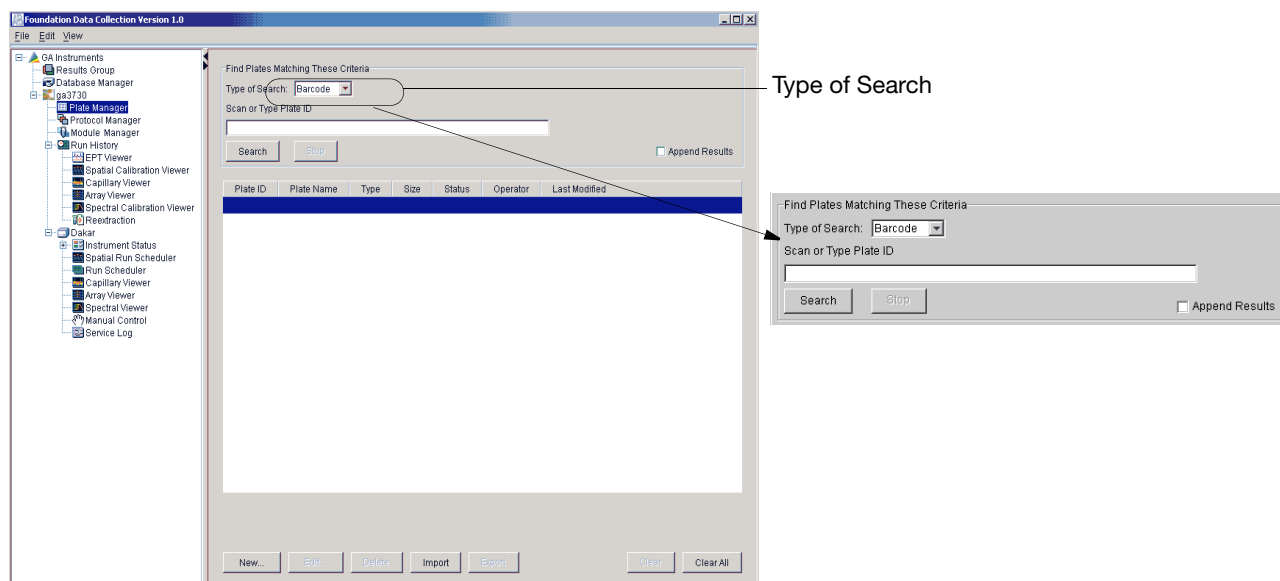

Figure 3-33 Barcode Search Window

The following table lists the elements of the Barcode search window.

Table 3-6 Elements of the Barcode Search window

Field	Description
Scan or Type Plate ID	Scan (using an external barcode scanner), or type a plate ID (barcode) into the field.
Search button	Starts the search for the plate ID entered in the Plate ID field. Once a match is found, the corresponding plate displays in the Plate List table.
Stop button	Enabled when a search is in progress. Allows you to stop the search.
Append Results	When checked, adds the found plate record to the Plate List table without removing previously searched entries.

Advanced Search Window

Within the Plate Manager window, choose Advanced Search from the Type of Search menu. The advanced search enables you to search for multiple plates simultaneously and by several different Plate Record attributes which are described below.

Toggle here between Barcode and Advanced

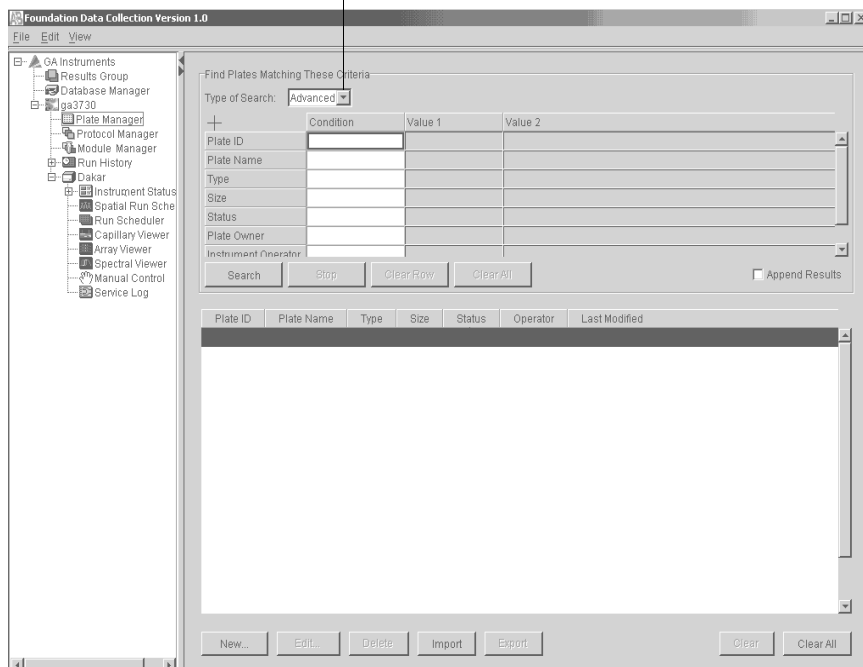

Figure 3-34 Advanced Search Window

The following table describes the columns of the Advanced Search window.

Table 3-7 Elements of the Advanced Search window

Column	Description
Condition	Defines search conditions for each of the search variables (see Figure 3-35 below).
Value 1	Contains the primary string to be used in the search.
Value 2	Contains a secondary string to be used in a search, such as an ending date. Note: Enabled only when using 'between' as a condition (see Figure 3-36 below).
Search button	Starts the search. Disabled when a search is in progress.
Stop button	Stops the search. Enabled when a search is in progress.
Clear Row button	Clears the conditions and values from the selected Variable row.
Clear All button	Clears the conditions and values from all of the Variable rows.
Append Results	When checked, adds the found plate to the Plate List table without removing previously searched entries.

Use the drop-down lists to define search conditions for each of the categories (Plate ID, Plate Name, Type, Size, etc.)

Find Plates Matching These Criteria

Type of Search:

Category	Condition	Value 1
Plate ID	Starts With	
Plate Name		
Type	=	
Size	<	
Status	>	
Plate Owner	Not Equal	
Instrument Operator	Contains	
	Between	
	Starts With	

Figure 3-35 Defining Search Conditions

Find Plates Matching These Criteria

Type of Search:

Category	Condition	Value 1	Value 2
Plate Name	Not Equal		
Type	Contains	SequencingAnalysis	
Size	Starts With	96-Well	
Status	Starts With	pending	
Plate Owner	=	Mr. Holmes	
Instrument Operator	Contains	Mr. Holmes	
Date Last Modified	Between		

Append Results

Figure 3-36 Value 2 column is only enabled when the 'between' condition is used.

Using The Plate List Table

To use the Plate List table:

1. Click a row in the Plate List table to select that Plate Record.
2. Double-click a row to open the Plate Editor for the chosen Plate Record.
3. Click a column header in the Plate List table to sort entries by that column's attributes.
4. Click again to toggle the entries in ascending and descending order. The following table describes the action buttons located in the lower portion of Plate List window.

Table 3-8 Elements of the Plate List window

Entry	Function
New button	Opens the New Plate dialog box (See page 3-9).
Open button	Opens the Plate Editor window for the selected plate record (see page 3-11).
Import button	Opens the Import dialog box. Use this to import plate records into the database.
Export button	Opens the Export dialog box. Use this to export plate records to a flat file (transfer) format. Enabled when a plate record is selected.
Delete button	Deletes the selected plate record from the local 3730/3730xl Data Collection database.
Clear button	Clears the selected plate record from the Plate List search results (not from the local 3730/3730xl Data Collection database).
Clear All button.	Clears all plates from the Plate List search results (not from the local 3730/3730xl Data Collection database).

Autoanalysis Integration

Establishing an Automation Pipeline Overview

If you want Autoanalysis to occur, you must follow the procedures below. If you do not follow the set up as it is described in the next three sections (“Create a Results Group,” “Create a Plate Record,” and “Schedule a Run”), Autoanalysis will not be performed.

Create a Results Group

To create a Results Group:

1. Click **Start > Programs > Applied Biosystems > Auto Analysis Manager**.

This launches the Autoanalysis Manager.

2. From Data Collection create a new Results Group:

- a. Click the Results Group icon in the left pane.
- b. Click **New** and the Results Group Editor displays.

3. Perform the following within the Group Editor window:

a. In the *General tab*:

- Enter Results Group Name (GeneMapper project name)
- Enter Results Group Owner
- Enter Results Group Comment (optional)

b. In the *Analysis tab*:

- Check Do Autoanalysis
- Select GeneMapper Instance (GeneMapper + Computer Name) from drop-down list
- Enter GeneMapper Login ID (GM)
- Enter GeneMapper Password (ifa)

Note: For GeneMapper Results the Analysis Protocols (Run 1, Run 2, etc.) are not used.

c. In the *Destination tab*:

- Either use default Location (leave as is) or, select a custom location using the browse function.

d. In the *Naming tab*:

- Define Sample File Name format that will be used to name generated samples. Choose two or more formats to define a unique sample name.
- Enter a Prefix (optional)
- Choose a Name delimiter (optional)

e. Define the Run Folder Name format that will be used to create run folder.

- Choose two or more formats to define a unique run folder name
- Enter a Prefix (optional)
- Choose a Name delimiter (optional)

4. Click **OK**. The newly created Results Group displays in the list.

Create a Plate Record

To create a Plate Record:

1. Click the ga3730 icon in the left pane.
2. Click the Plate Manager icon in the left pane.
The Plate Manager displays.
3. Click **New**.
The New Plate Dialog displays.
4. Enter plate information:
 - a. Enter ID Barcode
 - b. Enter Plate Name
 - c. Enter Description (optional)
 - d. Select GeneMapper Instance (GeneMapper + Computer Name) from the Application type drop-down list
 - e. Choose Plate Type
 - f. Choose Plate Sealing option
 - g. Enter Owner Name
 - h. Enter Operator Name
5. Click **OK**.
The GeneMapper Plate Editor displays.
6. Complete the sample sheet:
 - a. Enter sample name (this is the internal sample file name).
 - b. Enter Comment (optional).
 - c. Select your defined Results Group from drop-down list.
 - d. Select your GeneMapper Sample Type from drop-down list.
 - e. Select your GeneMapper Size Standard from drop-down list.
 - f. Select your GeneMapper Panel from drop-down list.
 - g. Select your GeneMapper Analysis Method from drop-down list.
 - h. Enter User Defined 1 comment (optional).
 - i. Enter User Defined 2 comment (optional).
 - j. Enter User Defined 3 comment (optional).
 - k. Select Instrument Protocol 1.
 - To create a new Instrument Protocol:
 - Select New from drop down list and the Protocol Editor displays.
 - Enter Protocol name
 - Enter description (optional)
 - Select Run Module (GeneScan 36_Pop7)
 - Select Dye Set (G5)
 - Click **OK** and new Instrument Protocol is available from drop-down list
 - l. Select additional Instrument Protocols (optional) Use this if you want to use the same sample information for additional runs
 - m. Enter description at the bottom of the sheet (optional)
 - n. Enter above information for each of the 48 wells containing sample product

7. Click **OK**.

The Plate Record displays in the list.

Schedule a Run To schedule a run:

1. Click the Instrument name icon in the left pane.
2. Click the Run Scheduler icon in the left pane.

The Run Scheduler displays.

3. Schedule all plates for the Results Group:
 - a. Click **Search**.
 - b. Click **Find All**.
 - c. Select all plates for your Results Group.
 - d. Click **Add**.
 - e. Click **Done**.

All the plates display in the Input Stack.

- f. Arrange plates (if necessary) in desired process order.
4. Process Plates:
 - a. Click the green process button (at the top left of the Run Scheduler pane)

The plates begin processing. The current plate being processed appears in Auto Sampler location. As the plate is completed it will be moved to Output Stack. After all plates belonging to Result Group have been processed, the Autoanalysis Manager receives notification that the project is ready.

GeneMapper Automation Begins

The GeneMapper automation process is listed below:

1. All samples generated for results group sent to Autoanalysis Manager
Appears in Job Queue list in General tab.
2. Results group passed to GeneMapper Autoanalysis Manager
Appears in Job Queue in GeneMapper 3.0 tab.
3. Results Group sent to GeneMapper application.
 - GeneMapper application opens, all samples from results group are added to new project
 - GeneMapper automatically begins analysis
 - Project is saved using Results Group name
 - GeneMapper application is closed at conclusion of analysis
4. GeneMapper sends back successful message to GeneMapper Autoanalysis Manager.
5. Status changed to Complete.
6. GeneMapper Autoanalysis sends update message to Autoanalysis Manager.
7. Status changed in General tab to Complete.

Spatial and Spectral Calibrations

4

In This Chapter	Spatial Calibration	4-2
	Spectral Calibration	4-9

Spatial Calibration

About Spatial Calibrations

A spatial calibration maps the pixel positions of the signal from each capillary in the spatial dimension of the CCD camera.

When to Calibrate A spatial calibration must be performed each time you:

- Install or replace a capillary array
- Temporarily remove the capillary array from the detection block
- Open the detection block door
- Move the instrument

Defective Capillary Information

A spatial calibration also provides information about a potentially defective capillary.

About Spatial Calibration Data

Introduction Before a spatial calibration can be performed, the spatial method file must be incorporated into a spatial protocol.

Creating Spatial Protocols

There are two spatial calibration run modules:

- Spatial calibration with the capillaries filled with polymer first (default module: spatial_fill)
A spatial calibration with fill is recommended whenever there is old polymer in the capillary array or the calibration is done after a run.
- Spatial calibration without the capillaries filled (default module: spatial_nofill)
A spatial calibration without fill is recommended whenever there is fresh/new polymer in the capillary array.

Note: Although the examples in this section are from a 96-capillary array, a 48-capillary array has similar criteria.

To perform a spatial calibration:

1. Expand the view in the tree pane.
 - a. Click the + box next to the GA Instruments icon.
 - b. Click the + box next to the ga3730 icon.
 - c. Click the + box next to the *instrument name* icon.
2. Click the Spatial Run Scheduler icon.
The Spatial Run Scheduler view opens.

3. Select the spatial protocol you want to use from the Spatial Protocols drop-down list box.
 - Use the SpatialFill protocol if the:
 - Capillaries have no polymer (*i.e.*, a new capillary array), or
 - Polymer in the capillaries was used in a run
 - Use the SpatialNoFill protocol if the capillaries contain fresh polymer.

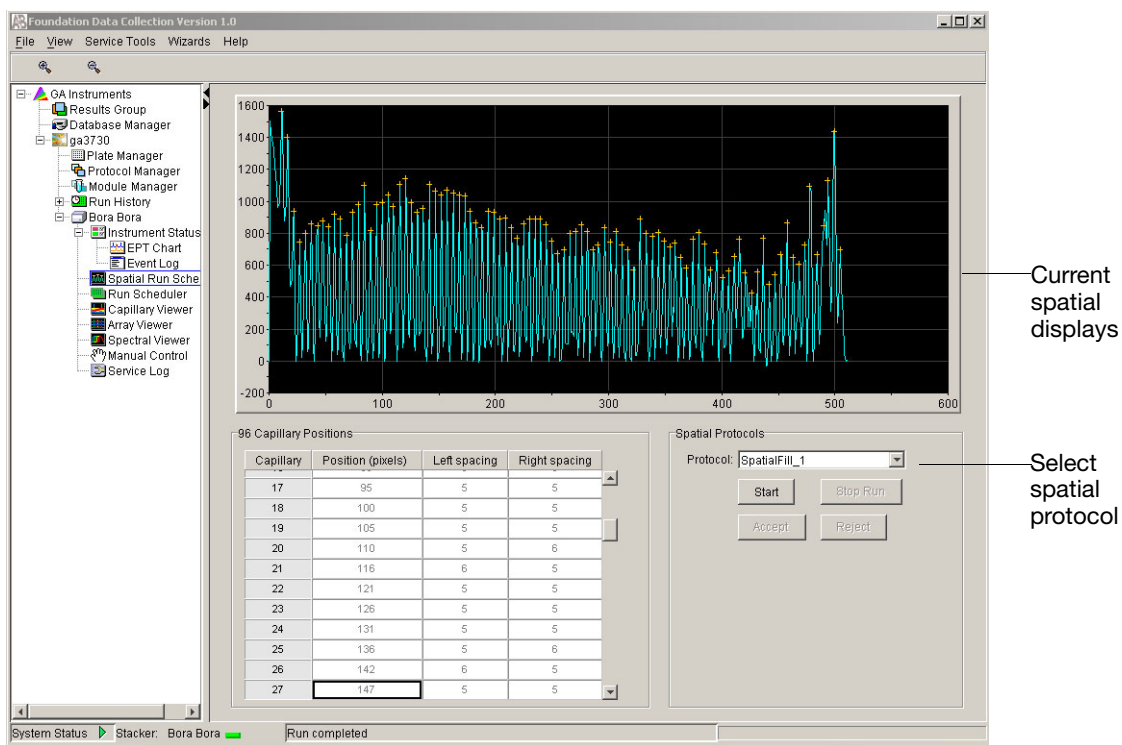

Figure 4-1 Spatial Run Scheduler view

Note: You need not fill the capillaries each time you perform a spatial calibration.

4. Click **Start**. The calibration takes approximately:
 - 2 min without filling the capillaries
 - 6 min with filling the capillaries

When the spatial is complete the view is updated.

5. Proceed to “Evaluating a Spatial Calibration Profile” on page 4-4.

Evaluating a Spatial Calibration Profile

Evaluation Criteria While viewing the calibration profile, use the following criteria to evaluate the data:

Table 4-1 Evaluation Criteria

Peak Attribute	Criteria
Spacing	Position values average 5 pixels higher for 96 capillaries and 10 pixels for 48 capillaries, than the previous one for every capillary.
Height	Uniform heights for all peaks.
Orange crosses	<p>One orange cross marking the top of every peak. No misplaced crosses.</p> <p>IMPORTANT! Frequently there is a peak artifact on the left side of the profile. Verify this peak is not identified by the algorithm as a real peak (see page 4-7).</p> <p>Note: The cross positions can not be altered after the spatial profile is accepted.</p> <p>To move a cross:</p> <ol style="list-style-type: none"> 1. Define a capillary position. 2. Change the value in a Position (pixel) column. 3. Click outside of that box.
Shape	<ul style="list-style-type: none"> • Single sharp peak for each capillary. • Small shoulders are acceptable.

Example of Passing Profile

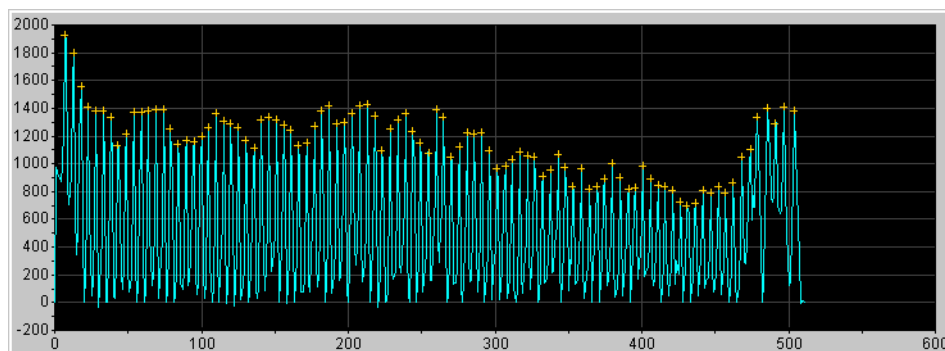

Figure 4-2 Passing Profile

**Example of
Passing Profile
with Peak Artifact**

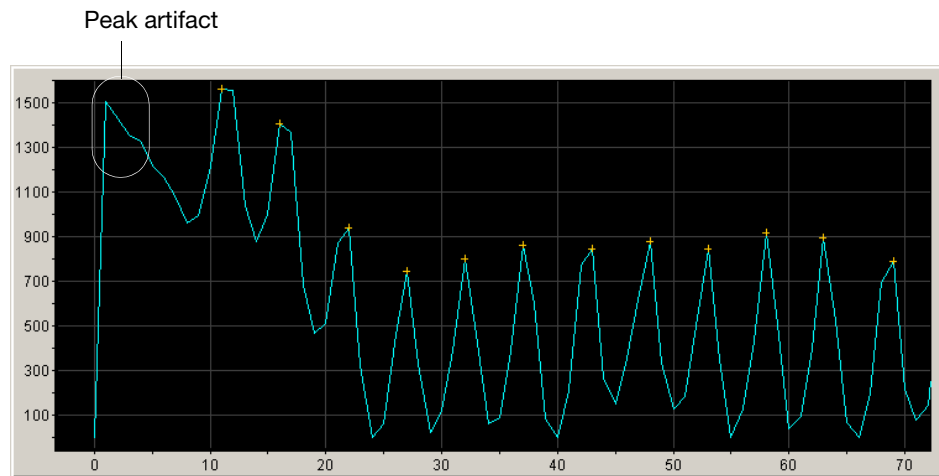

Figure 4-3 Peak Artifact

**Example of
Failing Profile**

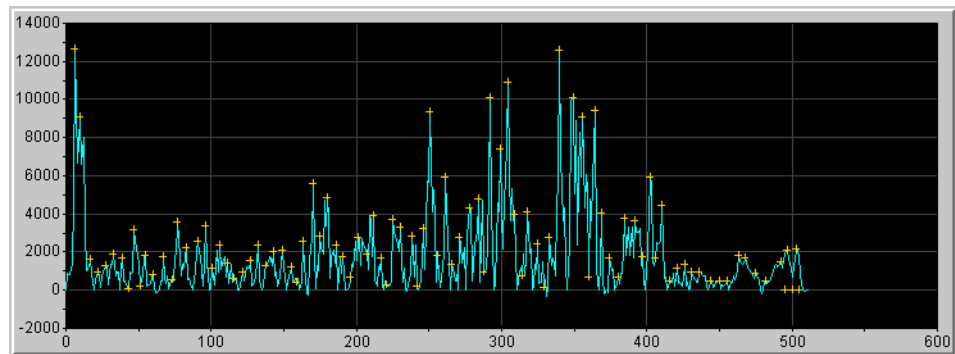
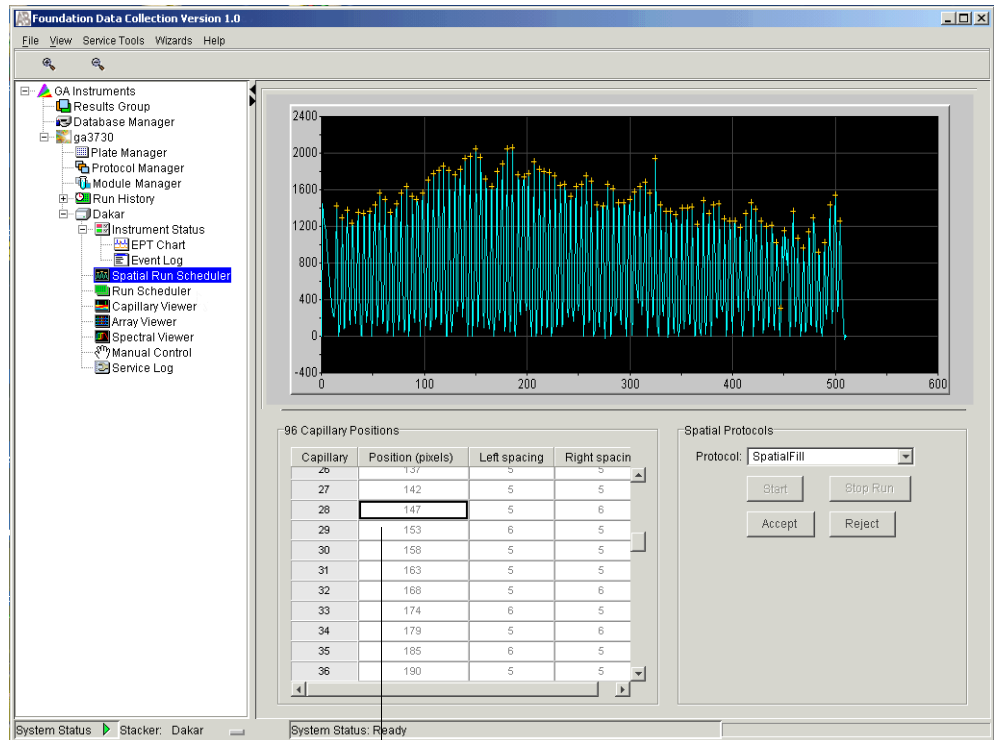

Figure 4-3 Failing Profile

Viewing the Results and Accepting or Rejecting the Data

To view the spatial calibration results and accept or reject the data:

1. Evaluate the spatial calibration profile using the criteria on page 4-4.



Change the cross position here

Figure 4-4 Viewing Results

2. In the 96 Capillary Positions section, scroll through all 96 capillaries and examine the pixel positions.

IMPORTANT! The capillaries for a 96-capillary array should be 4 to 8 pixels apart; 8-12 pixels apart for a 48-capillary array. Be sure to check the spatial profile for any capillaries that fall outside of this range.

3. Enhance the view to examine capillaries that fail the criteria:
 - a. Click-drag the cursor to create a box around the area of interest.

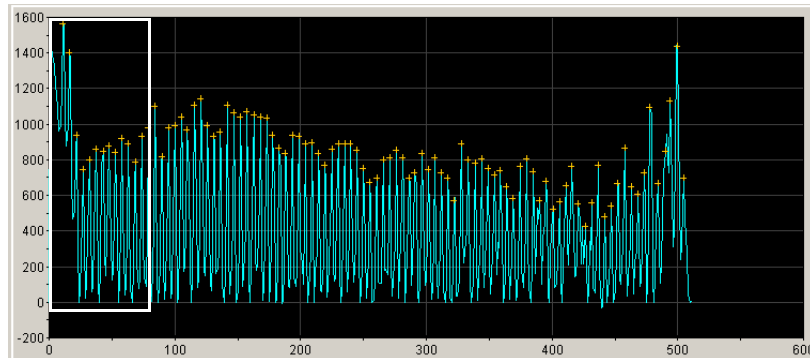

Figure 4-5 Standard View

- b. Release the cursor. The expanded view is displayed.

No orange cross—peak artifact

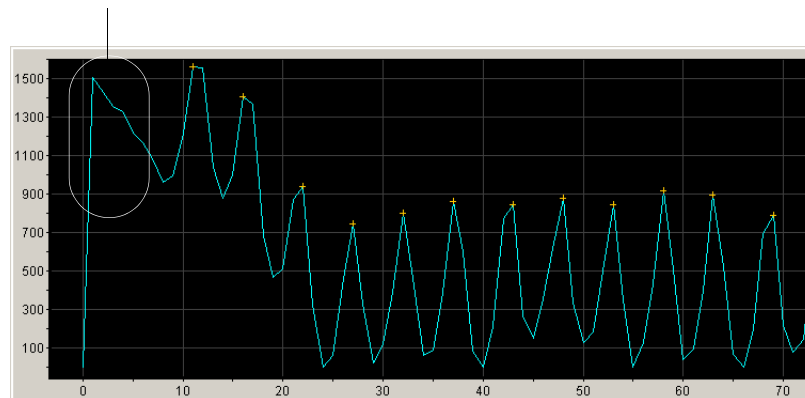

Figure 4-6 Enhanced View

- c. To reset the view, press R.

4. Accept or reject the spatial calibration.

If the spatial calibration profile is...	Then...
satisfactory	Click Accept . The data is stored in the database.
unsatisfactory	<ul style="list-style-type: none"> • Reposition one or more of the orange crosses. To move a cross, change the value in the Position (pixel) column, click Enter and then click Accept. or, • Click Reject, and then click Start to repeat the calibration. <p>If the calibration continues to provide unsatisfactory results, see “If the Calibration Fails” on page 4-8.</p>

If the Calibration Fails

If the calibration failed, or if you do not like the appearance of the passed calibration profile, try one or more of the following corrective actions.

- Repeat the calibration.
- Fill the capillaries with polymer, and then repeat the calibration.
- Clean the detection cell, and then repeat the calibration (see page 5-12).
- Reposition the array window in the detection cell, and then repeat the calibration.
- Change the capillary array

Spectral Calibration

About Spectral Calibrations

A spectral calibration creates a matrix that corrects for the overlapping fluorescence emission spectra of the dyes.

When to Calibrate You must perform a spectral calibration:

- Whenever you use a new dye set on the instrument
- After the laser or CCD camera has been realigned/replaced by a service engineer
- If you begin to see a decrease in spectral separation (pull-up and/or pull-down peaks)
- If you go from using a 96 capillary array to a 48 capillary array and, vice versa.

IMPORTANT! The instrument door must remain closed throughout a spectral calibration. If you want to monitor the progress of the calibration, refer to page 1-44.

Procedure Overview Performing a spectral calibration is similar to performing a sample run, except that calibration standards are run in place of samples, and a spectral calibration module is used in place of a run module.

Table 4-2 Spectral Calibration Procedure

Part	Description
Software setup	<p>Begin the procedure by preparing the instrument and a calibration standard. Next, you create a spectral protocol, plate record and schedule the run using the 3730 software. During the software setup, you are prompted to select a specific:</p> <ul style="list-style-type: none"> • Spectral run module (determines the run conditions for each array type) • Dye set (configures the software for the dye set you are using) • Spectral parameter file (selects the type of algorithm you want to use to process the data: matrixStandard or sequenceStandard)
Calibration	<p>During the calibration, dye-labeled DNA standards are electrophoresed, and the fluorescence data is collected and stored as temporary files. The matrix-making software analyzes this data and creates a spectral calibration matrix, which is used for sample data. Application of this matrix to the raw data is called multicomponenting.</p>
Data analysis	<p>After the calibration run, the software analyzes the matrices and assigns a capillary status value to each capillary.</p> <p>The matrix passes if it:</p> <ul style="list-style-type: none"> • Exhibits distinct fluorescence emission maxima for each of the dyes included in the dye set being used. • Meets the criteria specified in the selected spectral calibration parameter text file <p>A passed matrix must be assigned to every capillary before a sample run can be performed.</p> <p>The software automatically replaces matrices for failed capillaries with matrices created from capillaries that passed. The replacements are made from the next nearest capillary, with the left side taking priority over the right side.</p> <p>Even though the algorithm has passed a calibration matrix from a capillary, it does not mean that the calibration data should necessarily be used for sample data analysis. We recommend that you examine the calibration matrices before electing to save and use them for sample data processing.</p> <p>Ideally, each capillary has its own passed matrix. If you see a matrix that you do not want to use, you can use the Override Spectral Calibration command to replace the matrix with one from a neighboring capillary.</p>

Note: Do not launch the operating system's internet wizard during a spectral calibration as this causes the networking operation to fail.

Preparing Spectral Calibration Samples

Application and Dye Set

Use the table below to determine the appropriate dye set for the chosen application.

Application	Dye Set	Matrix Calibration Standard
Sequencing	E-BigDyeV1.1	Sequencing Standard
Sequencing	Z-BigDyeV3 Z-BigDyeV3.1	Sequencing Standard
Fragment Analysis	G5	Matrix Standard DS33-G5

Preparing the Standard

To prepare standards for spectral calibration:

1. a. **For sequencing:**

Resuspend a tube of BigDye Terminator v3.0 Sequencing Standard, BigDye Terminator v3.1 or, BigDye Terminator v1.1 Sequencing Standard, with 1.0 mL of Hi-Di™ formamide.

b. **For fragment analysis:**

Resuspend 75 µL of DS 33 Matrix Standard in 435µL of Hi-Di™ formamide

⚠ WARNING CHEMICAL HAZARD. Formamide causes eye, skin, and respiratory tract irritation. It is a possible reproductive and birth defect hazard. Read the MSDS, and follow the handling instructions. Wear appropriate protective eyewear, clothing, and gloves.

2. Vortex thoroughly.
3. Spin the mixture briefly in a microcentrifuge.
4. Heat the standard tube at 95 °C for 5 minutes to denature the DNA.
5. Immediately place the tubes on ice for 2 minutes.

Loading the Standards

To load the standards:

1. Dispense this amount of denatured standard:
 - 10 μ L into all wells of a 96-well plate.
 - 5 μ L into wells A1, C1, E1, etc. of a 384-well plate (as shown below).

Note: For a 48-capillary fragment analysis run, load every other column of wells on a 96-well plate.

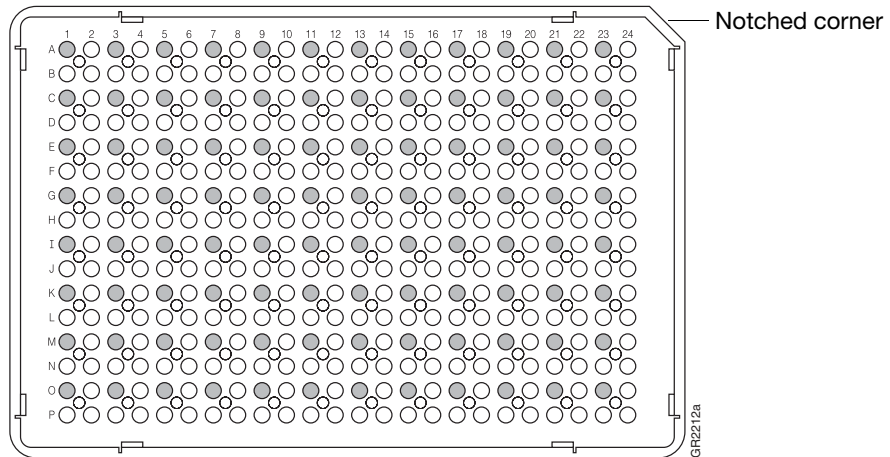

2. Centrifuge the plate so that each standard is positioned at the bottom of its well. Your samples should:

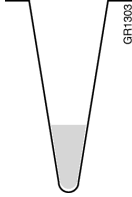
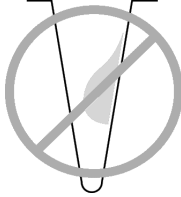
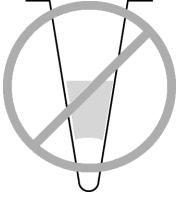
Look like this...	Not look like this...	Not look like this...
 <p data-bbox="513 1356 760 1436">The sample is positioned correctly in the bottom of the well.</p>	 <p data-bbox="805 1356 1052 1465">The sample lies on the side wall because the plate was not centrifuged.</p>	 <p data-bbox="1094 1356 1341 1465">An air bubble lies at the bottom of the well because the plate was not:</p> <ul style="list-style-type: none"> • Centrifuged with enough force, or • Centrifuged for enough time

Performing a Spectral Calibration

Introduction Use the procedure below to perform a basic, “default” spectral calibration.

Creating a Spectral Protocol Before a spectral calibration can be performed, the spectral module file must be incorporated into a spectral protocol. If valid spectral protocols have already been created, then proceed to “Creating a Plate Record” on page 4-16.

Use the table below as a guide when setting up a spectral protocol for specific applications:

Table 4-3 Spectral Protocols for Specific Applications

Application	Dye Set	Matrix Calibration Standard	Capillary Length (cm)	Module	Parameter File (Params)
Sequencing	E-BigDyeV1.1	Sequencing Standard	50	Spect50_SeqStd_POP7	SeqStd{E}.par
Sequencing	Z-BigDyeV3 Z-BigDyeV3.1	Sequencing Standard	50	Spect50_SeqStd_POP7	SeqStd{Z}.par
Sequencing	E-BigDyeV1.1	Sequencing Standard	36	Spect36_SeqStd_POP7	SeqStd{E}.par
Sequencing	Z-BigDyeV3 Z-BigDyeV3.1	Sequencing Standard	36	Spect36_SeqStd_POP7	SeqStd{Z}.par
Fragment Analysis	G5	Matrix Standard DS33-G5	36	Spect36_MtxStd_POP7	MtxStd{G5}.par

To create a spectral protocol:

1. Expand the view in the tree pane.
 - a. Click the + box next to the GA Instruments icon.
 - b. Click the + box next to the ga3730 icon.
2. Click the Protocol Manager icon.

The Protocol Manager view displays.

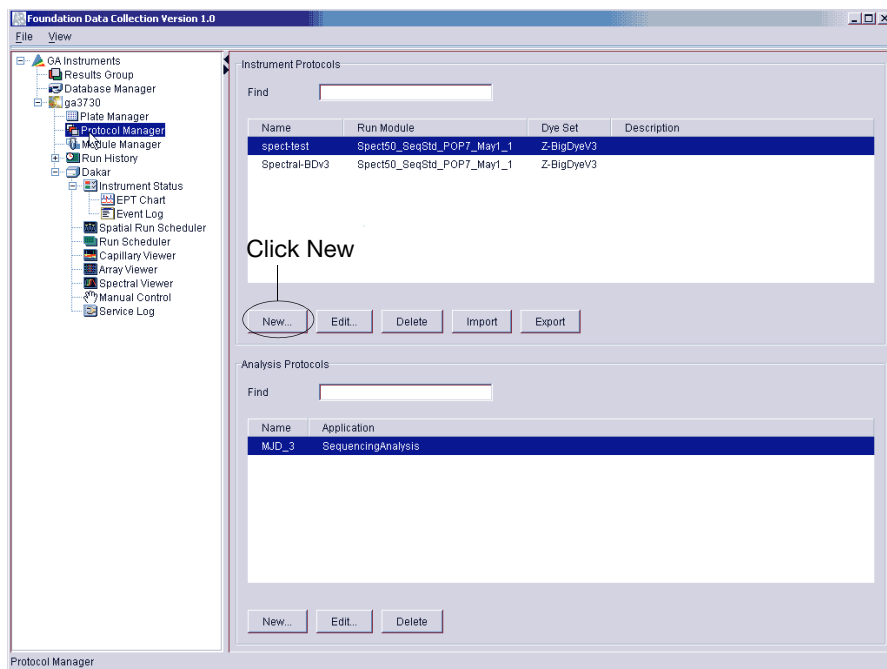

Figure 4-7 Protocol Manager view

3. In the Instrument Protocols section, click **New**.
The Protocol Editor dialog box opens.

4. Create a spectral module:

Note: The following procedure uses BigDye Terminator v3.0 or v3.1. If you are using version 1.1, instructions are in parenthesis.

- a. Type **SpectralZ** (for v.1.1, **SpectraE**) or a similar name in the Name field.
- b. Type a description for the spectral protocol (optional).
- c. Select **SPECTRAL** from the Type drop-down list.
- d. Select **Spect50_SeqStd_POP7** from the Run drop-down list. Or, depending on the dye set you are using, **Spect36_SeqStd_POP7**.
- e. Select **Z-BigDyeV3** (for v.1.1, **Z-BigDyeV1**) from the Dye Set drop-down list.
- f. Select **SeqStd{Z}.par** (for v.1.1, **SeqStd{E}.par**) from the Params drop-down list.

IMPORTANT! Make sure the correct spectral parameter file has been selected for the dye set you are running. Selecting the incorrect parameter file causes the spectral calibration to fail.

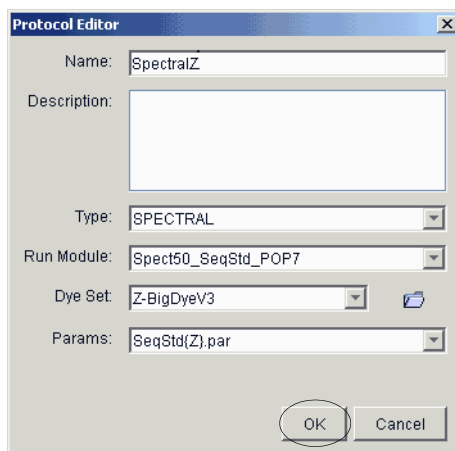

Figure 4-8 Example of the Protocol Editor completed for BigDye v3.0 and v3.1

5. Click **OK**.

The module is saved and displayed in the Instrument Protocols section of the Protocol Manager view.

Creating a Plate Record

The following is an example of creating/editing a protocol for Dye set Z for BigDye Terminator v3.0 chemistry. See Table 4-3 on page 4-13 for the appropriate modules and parameter files for other dye sets.

To create a plate record:

1. Expand the view in the tree pane.
 - a. Click the + box next to the GA Instruments icon.
 - b. Click the + box next to the ga3730 icon.
2. Click the Plate Manager  icon.

The Plate Manager view opens.

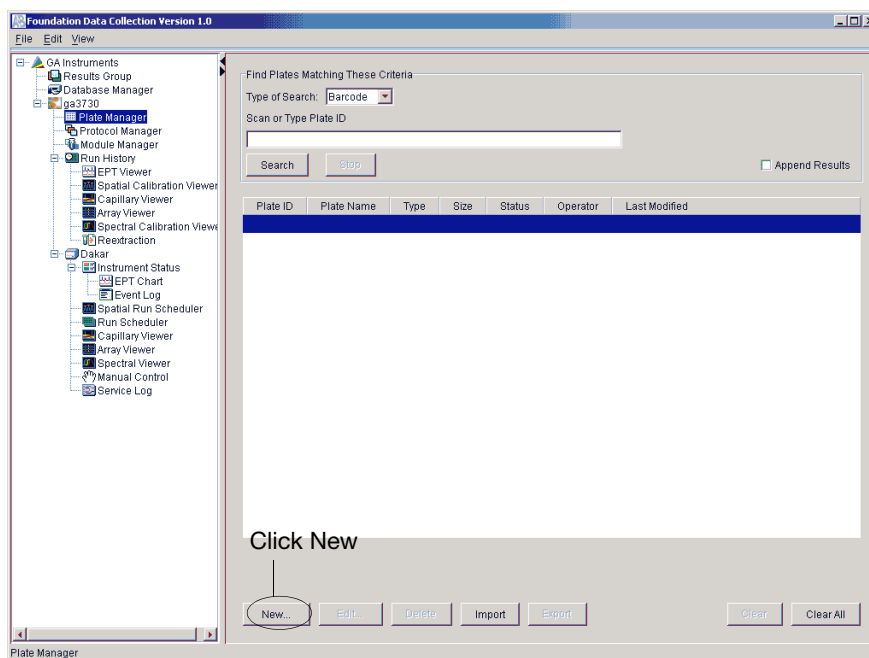

Figure 4-9 Plate Manager view

3. Click **New**.
The New Plate Dialog box opens.

4. Complete the plate information:
 - a. Type a name for the plate ID in the ID (Barcode) field.
 - b. Type a name for the plate in the Name field.
 - c. Optional: Type a description for the plate record.
 - d. Select **Spectral Calibration** from the Application drop-down list.
 - e. Select **96-Well** or **384-Well** from the Plate Type drop-down list.
 - f. Select **Heat Sealing** or **Septa** from the Plate Sealing drop-down list.
 - g. Type a name for the owner and operator in the appropriate fields.

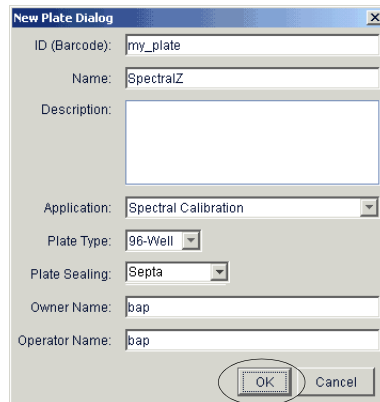

Figure 4-10 New Plate Dialog

- h. Click **OK**.
A blank plate record opens.

5. Complete the plate record:
 - a. In the Sample Name column, type a name.
 - b. Optional: In the Comments column, type your comments.
 - c. In the Instrument Protocol 1 column, select the protocol created in the “Creating a Spectral Protocol” section.
 - d. For a 96-well plate: Select the Sample Name, Comment and Instrument Protocol 1 columns, and fill down.
 For a 384-well plate: Complete the information accordingly to the load pattern in step 1 on page 4-12.

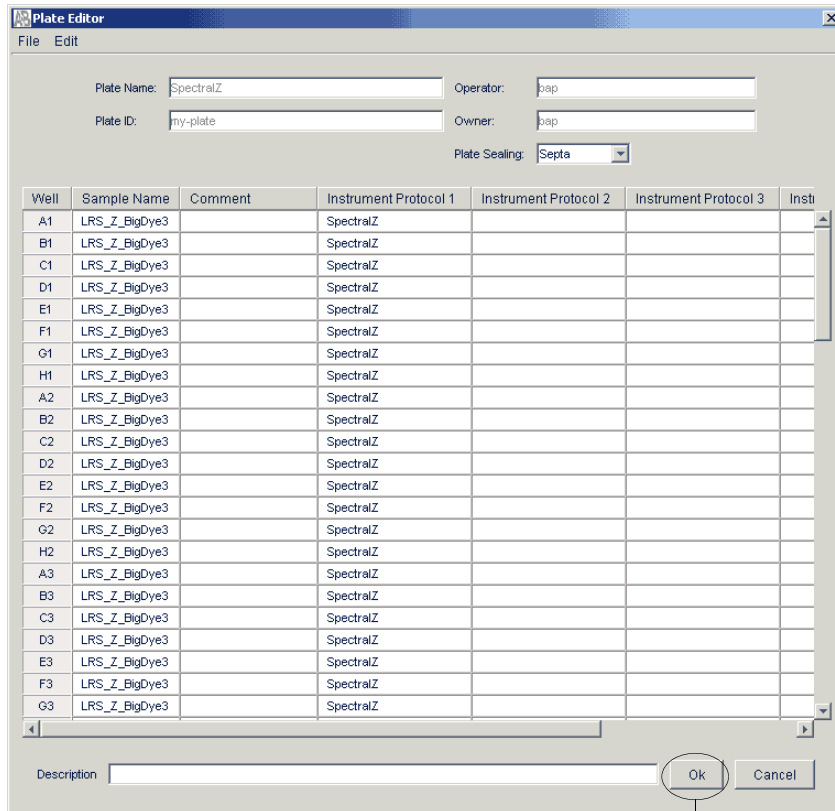

Figure 4-11 Plate Record

Click OK

- e. Click **OK**.

Note: The plate name, plate ID, operator, and owner names can not be changed in this window.

Adding a Plate to the Run Scheduler

To add a plate to the Run Scheduler:

1. Click the **Run Scheduler** icon.
The Run Scheduler view opens.

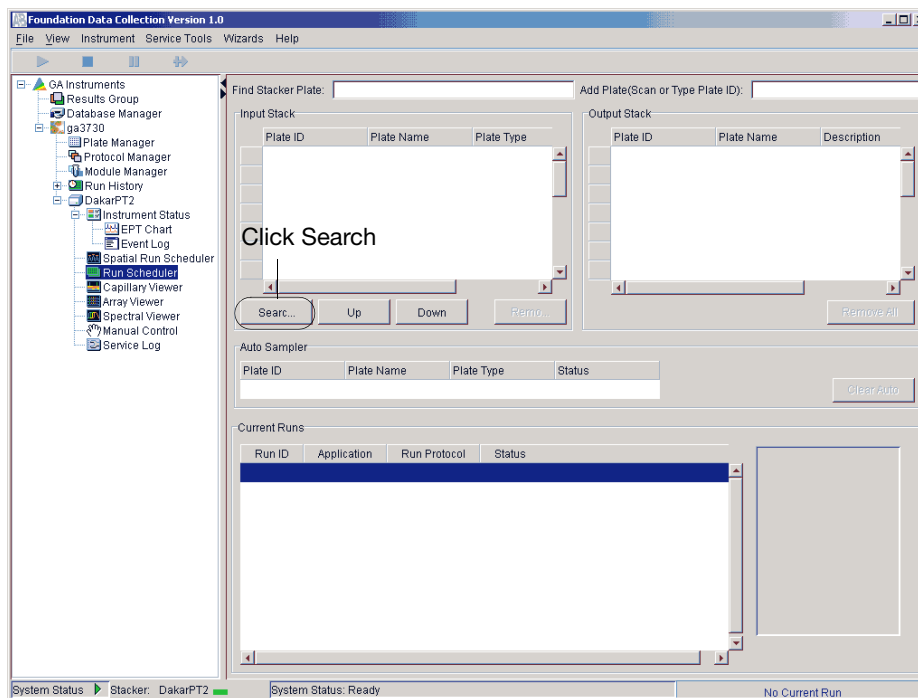

Figure 4-12 Run Scheduler

2. In the Input Stack section, click **Search**.
A search dialog box opens.

3. Search for the spectral calibration plate record:
 - a. Select **Advanced** from the Type of Search drop-down list.
 - b. In the Plate ID or the Plate Name row, set up the search for all plates.
 - Select **Contains** from the Condition column drop-down list.

The example below shows how you can narrow your search using various criteria.

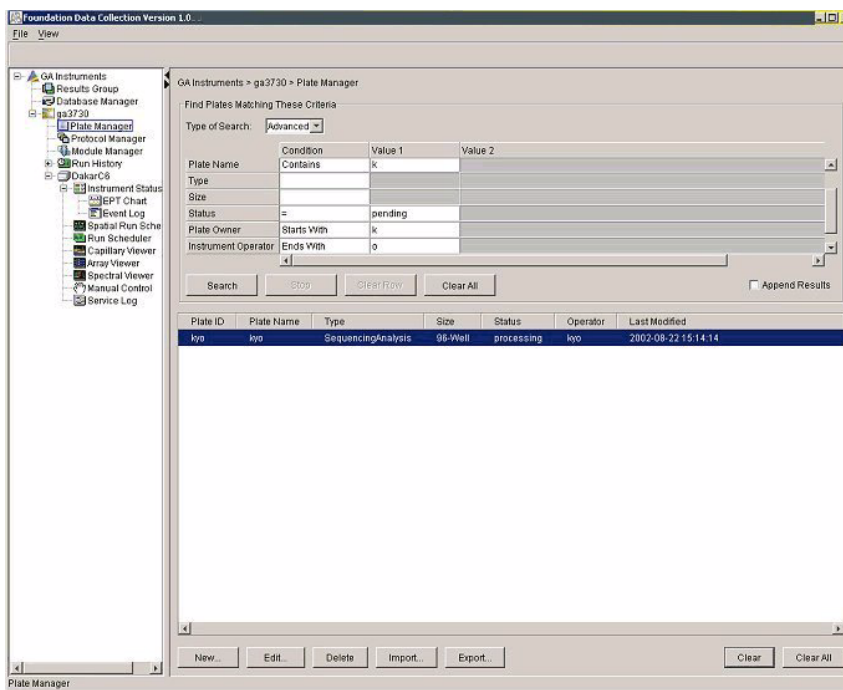
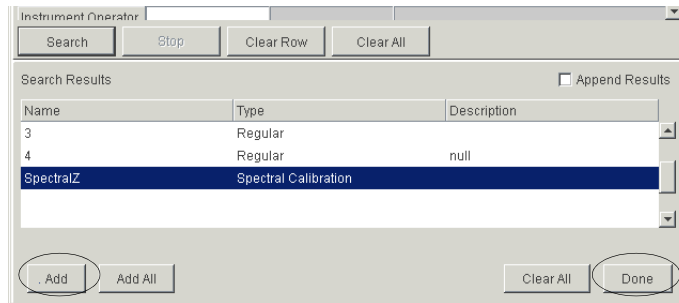

Figure 4-13 Narrowing The Search

- c. Click **Search**.
The results of the search is displayed in the Search Results section of the dialog box.

4. Add the plate record:
 - a. Select the plate you want to use in the Name column.



- b. Click **Add**.
- c. Click **Done**.

The plate is added to the Run Scheduler view.

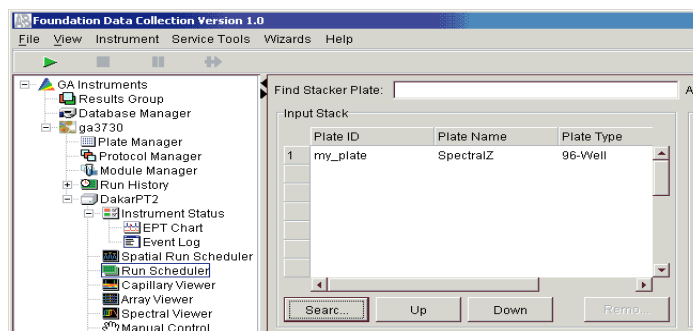

Starting the Calibration Run

To start the calibration run:

1. Click .
2. Click the **Instrument Status** icon to expand it.

Note: The instrument oven must come to temperature before the run begins. Once data is being collected, you can view it in the Array Viewer.

3. View the real-time data, click the **Array Viewer** icon to view all capillaries at one time.

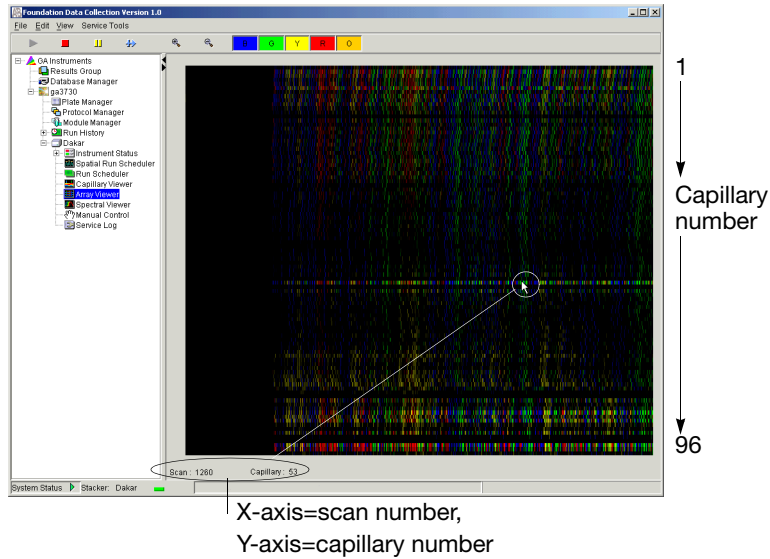

Figure 4-14 Array Viewer

4. Click the **Capillary Viewer** icon to view:
 - Individual capillary data being collected in real time (upper plot).
 - Entire data trace collected (lower plot).

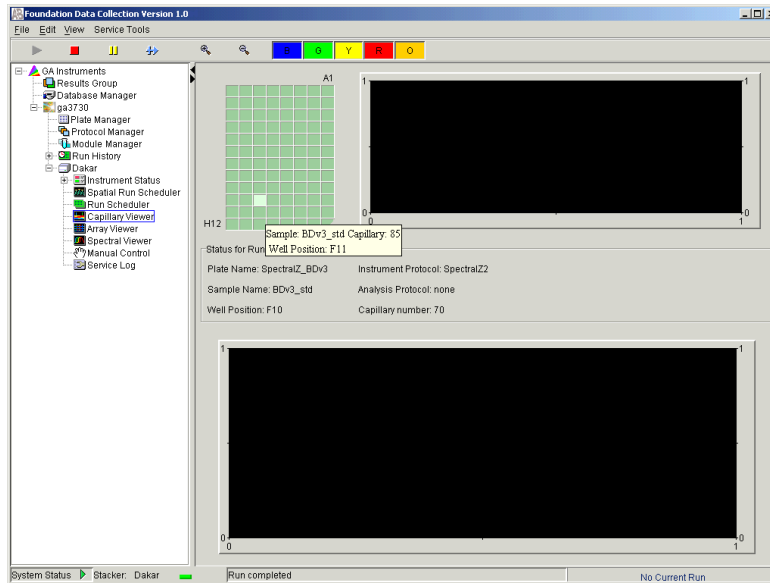

Figure 4-15 Capillary Viewer

Run Times The following table lists spectral calibration run times:

Application	Capillary Array Length (cm)	Approximate Run Time (min)
Sequencing	50	120*
Sequencing	36	60**
Fragment Analysis	36	35

* When using SeqStd for matrix calibration, it may take ~30 minutes for the matrices to be calculated after the run. Do not open the instrument door until plate is returned to the out stack.

** Applies to 50 and 36 cm arrays

Spectral Calibration Result Box

At the end of the run, while the data is being analyzed, the Spectral Calibration Result dialog box opens to indicate which capillaries have passed or failed.

IMPORTANT! Review and evaluate the spectral calibration profile for each capillary, even if the Spectral Calibration Results box indicated that they all passed.

When a Capillary Fails

If a capillary fails, it is automatically assigned the spectral profile of its nearest passing capillary to the left. If there are no passing capillaries to the left, it is assigned the profile of the nearest passing capillary to the right.

For applications where pull-up and pull-down peaks cause critical errors, we recommend that you repeat the spectral calibration and use a unique spectral for each capillary.

When the Calibration Fails

If the spectral calibration failed, or if you do not like the appearance of the passed calibration, try one or more of the following:

- Verify that the correct parameter file and run module were selected. If not, correct, and then repeat the run.
- Verify the freshness of the reagents used.

Evaluating the Spectral Calibration Results

Viewing the Results

It is important to check the event log at the end of a run.

To view the spectral calibration results:

1. Expand the view in the tree pane.
 - a. Click the + box next to the GA Instruments icon.
 - b. Click the + box next to the ga3730 icon.
 - c. Click the + box next to the *instrument name* icon.
2. Click the **Spectral Viewer** icon and a profile is displayed.

3. In the Dye Set section, select **Z-BIGDYE V3** from the Dye Set drop-down list.

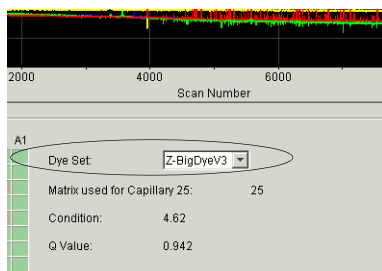

4. Select a well on the plate diagram to view a capillary number and evaluate the spectral calibration profile.

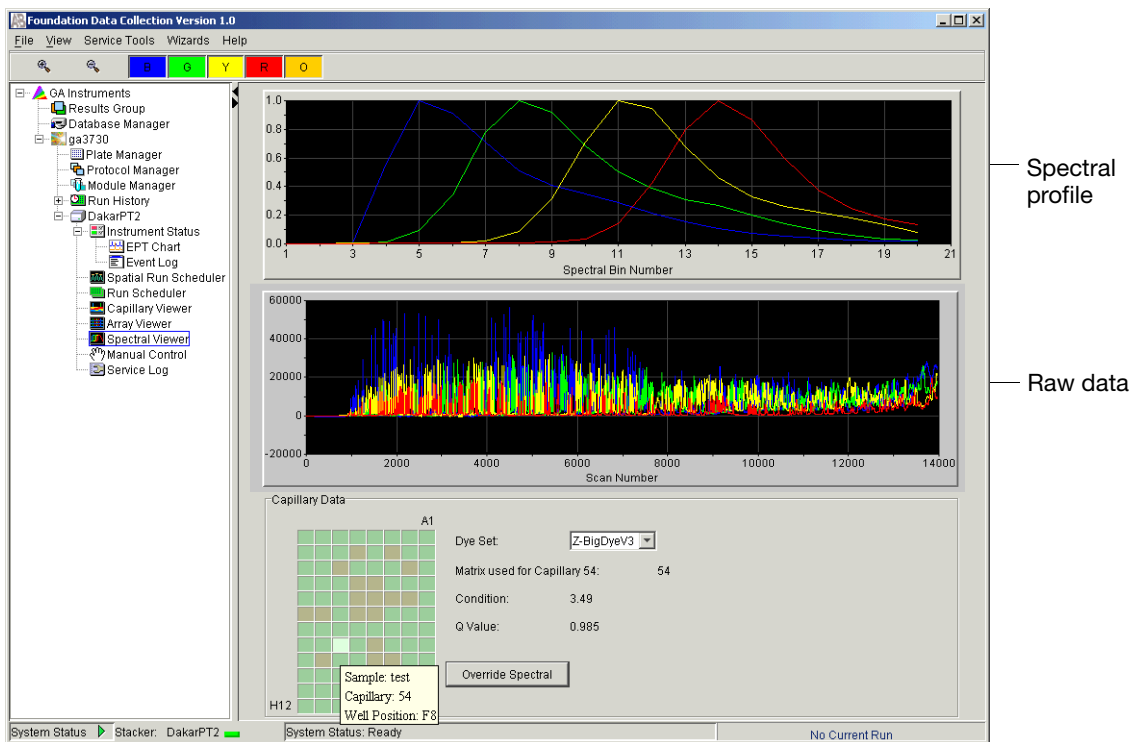

Plate diagram well colors:
 green: passed
 light green: selected
 tan: failed

Figure 4-16 Evaluating The Profile

5. For a closer view of the raw data or spectral profile:
 - a. Click-drag the cursor to create a box around the area of interest
 - b. Release the mouse. The expanded view is displayed.
 - c. To reset the view, press R.

Evaluation Criteria While viewing the dye set Z calibration profile, use the following criteria to evaluate the data:

Attribute	Criteria
Spectral Profile	<ul style="list-style-type: none"> Peak order from left to right is blue-green-yellow-red Separation of dye peaks

Example of Passing Profile

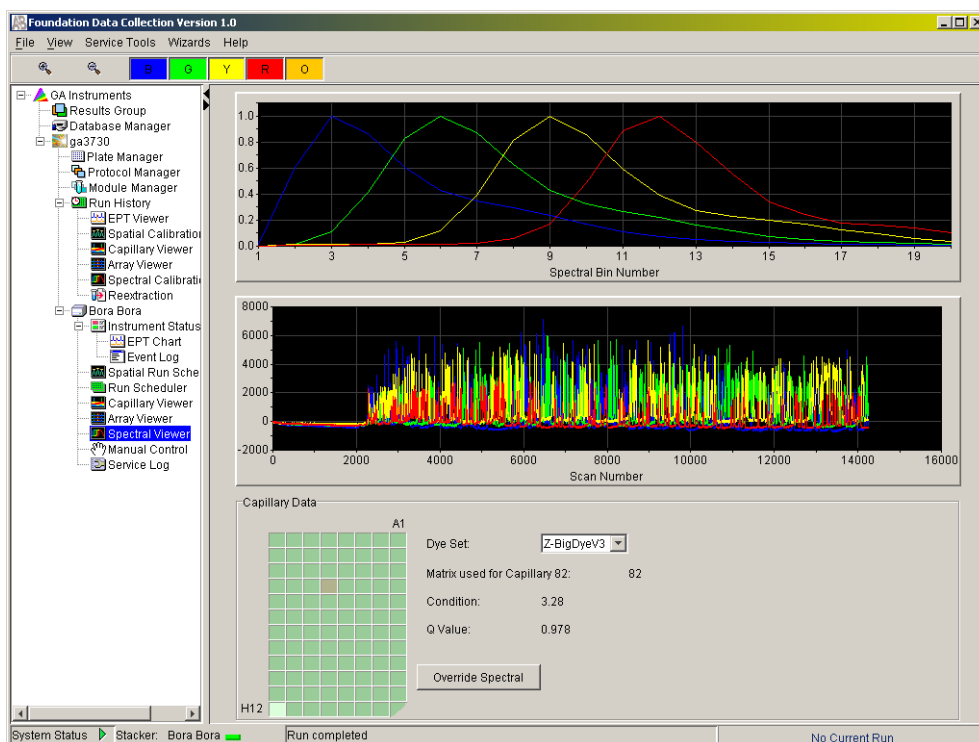

Figure 4-17 Z-BigDyeV3 sequencing

Example of Failed Profile

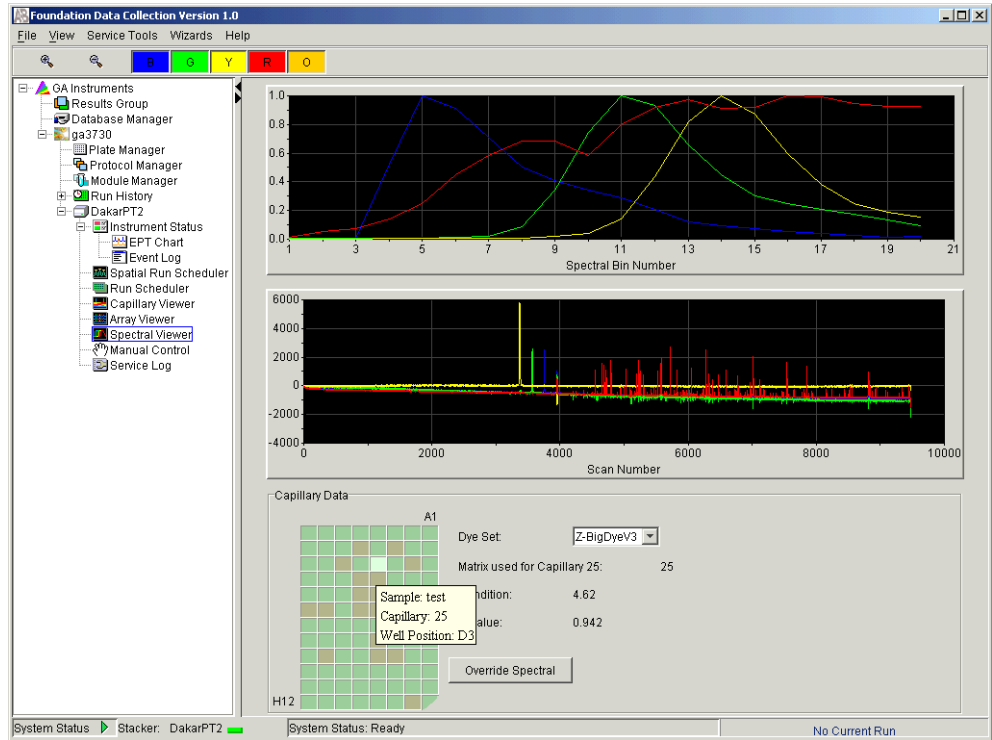

Figure 4-18 Z-BigDyeV3 sequencing

Example of Passing G5 Profile

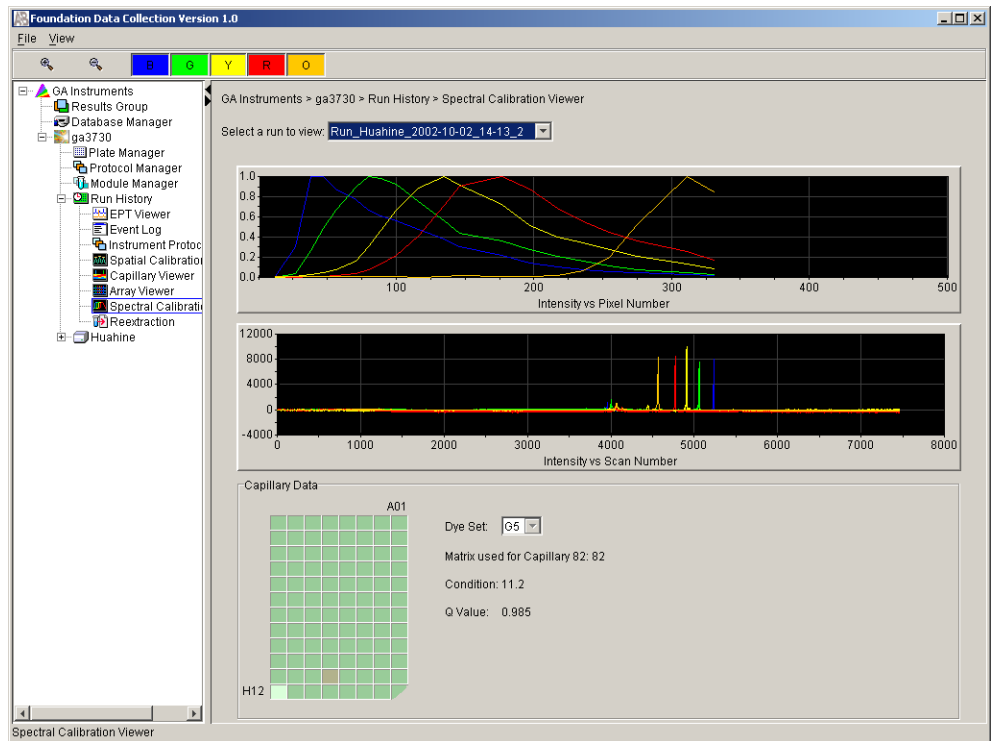

Figure 4-19 G-5 fragment analysis

Overriding a Spectral Profile

To override a spectral calibration profile:

1. Review the data.
2. In the plate diagram, select the capillary spectral profile you want to override.

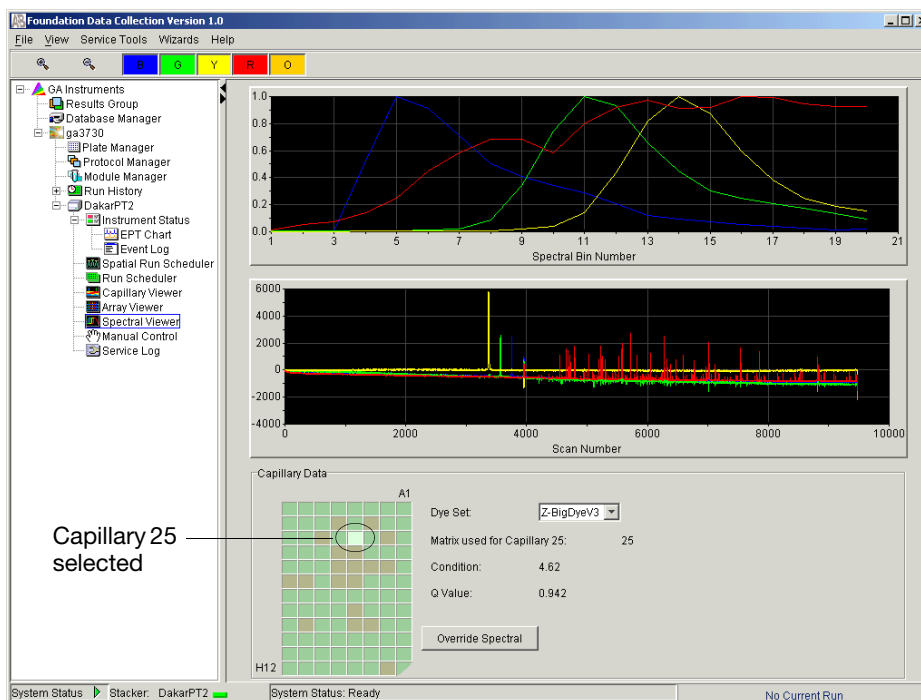
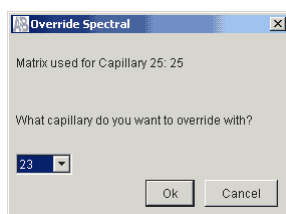

Figure 4-20 Overriding a Spectral Profile

3. Click **Override Spectral** and enter a new capillary value.



4. Click **OK**.

Viewing the Pass/Fail Status

A log file is created at the end of the spectral calibration. This log contains the pass/fail status, Q value, and condition number for each capillary.

To view the pass/fail status of each capillary:

1. Locate the log file.
 - a. For **sequencing**, locate the file at:
E:\AppliedBiosystems\UDC\DataCollection\Data\ga3730\
instrument name\SpectralCalMclFiles\Z-BigDyeV3
 - b. For **fragment analysis**, locate the file at:
E:\AppliedBiosystems\UDC\DataCollection\Data\ga3730\
instrument name\SpectralCalMclFiles\G5
2. Open the file in Notepad.
3. View the results.

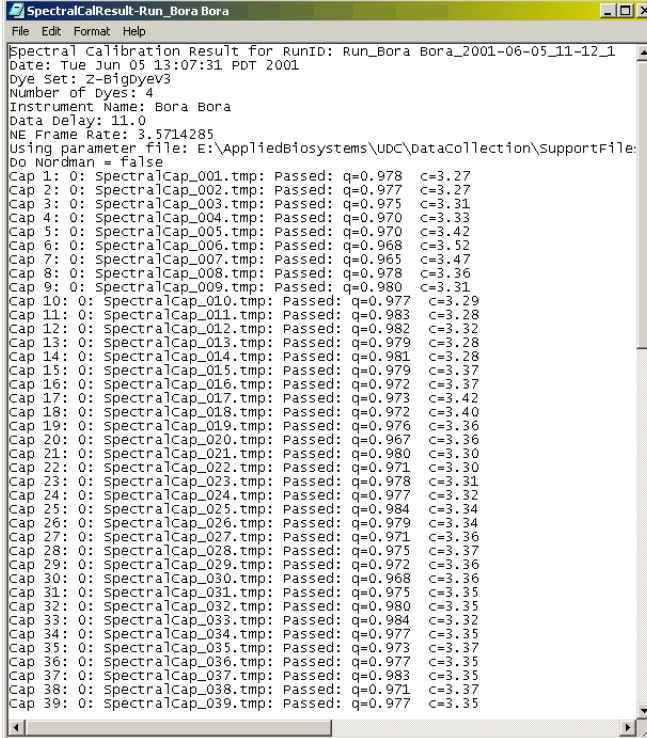

```

Spectral Calibration Result for RunID: Run_Bora Bora_2001-06-05_11-12_1
Date: Tue Jun 05 13:07:31 PDT 2001
Dye set: Z-BigDyeV3
Number of Dyes: 4
Instrument Name: Bora Bora
Data Delay: 11.0
NE Frame Rate: 3.5714285
Using parameter file: E:\AppliedBiosystems\UDC\DataCollection\SupportFile:
Do Nordman = false
Cap 1: 0: SpectralCap_001.tmp: Passed: q=0.978 c=3.27
Cap 2: 0: SpectralCap_002.tmp: Passed: q=0.977 c=3.27
Cap 3: 0: SpectralCap_003.tmp: Passed: q=0.975 c=3.31
Cap 4: 0: SpectralCap_004.tmp: Passed: q=0.970 c=3.33
Cap 5: 0: SpectralCap_005.tmp: Passed: q=0.970 c=3.42
Cap 6: 0: SpectralCap_006.tmp: Passed: q=0.968 c=3.52
Cap 7: 0: SpectralCap_007.tmp: Passed: q=0.965 c=3.47
Cap 8: 0: SpectralCap_008.tmp: Passed: q=0.978 c=3.36
Cap 9: 0: SpectralCap_009.tmp: Passed: q=0.980 c=3.31
Cap 10: 0: SpectralCap_010.tmp: Passed: q=0.977 c=3.29
Cap 11: 0: SpectralCap_011.tmp: Passed: q=0.983 c=3.28
Cap 12: 0: SpectralCap_012.tmp: Passed: q=0.982 c=3.32
Cap 13: 0: SpectralCap_013.tmp: Passed: q=0.979 c=3.28
Cap 14: 0: SpectralCap_014.tmp: Passed: q=0.981 c=3.28
Cap 15: 0: SpectralCap_015.tmp: Passed: q=0.979 c=3.37
Cap 16: 0: SpectralCap_016.tmp: Passed: q=0.972 c=3.37
Cap 17: 0: SpectralCap_017.tmp: Passed: q=0.973 c=3.42
Cap 18: 0: SpectralCap_018.tmp: Passed: q=0.972 c=3.40
Cap 19: 0: SpectralCap_019.tmp: Passed: q=0.976 c=3.36
Cap 20: 0: SpectralCap_020.tmp: Passed: q=0.967 c=3.36
Cap 21: 0: SpectralCap_021.tmp: Passed: q=0.980 c=3.30
Cap 22: 0: SpectralCap_022.tmp: Passed: q=0.971 c=3.30
Cap 23: 0: SpectralCap_023.tmp: Passed: q=0.978 c=3.31
Cap 24: 0: SpectralCap_024.tmp: Passed: q=0.977 c=3.32
Cap 25: 0: SpectralCap_025.tmp: Passed: q=0.984 c=3.34
Cap 26: 0: SpectralCap_026.tmp: Passed: q=0.979 c=3.34
Cap 27: 0: SpectralCap_027.tmp: Passed: q=0.971 c=3.36
Cap 28: 0: SpectralCap_028.tmp: Passed: q=0.975 c=3.37
Cap 29: 0: SpectralCap_029.tmp: Passed: q=0.972 c=3.36
Cap 30: 0: SpectralCap_030.tmp: Passed: q=0.968 c=3.36
Cap 31: 0: SpectralCap_031.tmp: Passed: q=0.975 c=3.35
Cap 32: 0: SpectralCap_032.tmp: Passed: q=0.980 c=3.35
Cap 33: 0: SpectralCap_033.tmp: Passed: q=0.984 c=3.32
Cap 34: 0: SpectralCap_034.tmp: Passed: q=0.977 c=3.35
Cap 35: 0: SpectralCap_035.tmp: Passed: q=0.973 c=3.37
Cap 36: 0: SpectralCap_036.tmp: Passed: q=0.977 c=3.35
Cap 37: 0: SpectralCap_037.tmp: Passed: q=0.983 c=3.35
Cap 38: 0: SpectralCap_038.tmp: Passed: q=0.971 c=3.37
Cap 39: 0: SpectralCap_039.tmp: Passed: q=0.977 c=3.35
  
```

Figure 4-21 Log files in Notepad

Note: To monitor a spectral calibration while it is in progress, open the Event Log (see 1-44).

In This Chapter	Instrument Maintenance	5-2
	Routine Cleaning	5-3
	Fluids and Waste	5-9
	Capillary Array	5-12
	Syringes	5-18
	Polymer Blocks	5-21
	Checking Available Space on Drives D, E, and F	5-30
	Hard Disk Status	5-31
	Deleting Records from the Database	5-32

Instrument Maintenance

Maintenance Task Lists

Overview This section lists common tasks required to maintain your Applied Biosystems 3730/3730xl DNA Analyzers in good working condition. The tasks are divided into tables based on how often you should perform each task.

IMPORTANT! Wear gloves any time you handle the capillary array, glass syringes, septa, buffer reservoirs, polymer bottles, polymer blocks, interconnect tubing, and bottle cap tubing.

Daily Tasks Perform these tasks at least once per day.

Table 5-1 Daily Maintenance Tasks

Maintenance Task	Frequency
Ensure adequate levels of buffer and water in reservoirs.	Before each run
Ensure the plate assemblies were put together properly. IMPORTANT! The holes in the plate retainer must align with the holes in the septa or the capillary tips will be damaged.	Before each run
Ensure the plate assemblies are positioned on the plate deck properly. Plates should sit snugly on the deck. IMPORTANT! Never use warped plates.	Before each run
Check the level of buffer in the buffer jar and ensure that the drain hole is not occluded	Before each run
Replace the water and 1X running buffer reservoirs on the instrument.	Every 24 hours
Check for bubbles in the polymer block, interconnecting tubing, polymer cap tubing and polymer block channels, and syringe. Remove all bubbles. For opaque tubing, manually flush polymer with syringe	Daily or before each run
Check the loading-end header to ensure the capillary tips are not crushed or damaged.	Daily or before each run
Check the level of polymer in the bottle to ensure sufficient volume for runs.	Daily or before each run
Check the polymer block to ensure it fits securely on the instrument.	Daily
Clean the instrument surfaces.	Daily
Check for dried polymer around the polymer block and clean as necessary.	Daily
Check for leaks around the syringe, array knob, interconnecting tube nut, and check valve. Also ensure that the buffer jar drain hole is not occluded.	Daily

Weekly Tasks Perform these tasks at least once per week.

Table 5-2 Weekly Maintenance Tasks

Maintenance Task	Frequency	See Page...
Clean the syringe.	Weekly or when the polymer is changed	5-18
Clean the water and buffer reservoirs with warm water.	Weekly or when the polymer is changed	—
Clean the complete polymer path including the upper and lower polymer blocks.	Weekly or when the polymer is changed	5-22
Replace the polymer in the bottle, syringe, upper polymer block, and capillary array.	Weekly or as needed	5-9
Check the storage conditions of the used arrays.	Weekly	—

As-Needed Tasks Perform these tasks as needed.

Table 5-3 As Needed Maintenance Tasks

Maintenance Task	Frequency	See Page...
Clean the drip tray.	As needed	—
Change the array.	As needed	5-13
Change syringe.	3 months	5-18
Remove any dried polymer from the capillary tips. Use a lint-free wipe moistened with deionized water.	As needed	—

Routine Cleaning

General Cleaning To clean the instrument:

1. Ensure the oven door, the instrument door, and the stacker are closed.
2. Press the Tray button on the front of the instrument to move the autosampler to the forward position.
3. Wipe off any liquid on or around the autosampler using a lint-free tissue.
4. Clean out the drip tray with deionized water and lint-free tissue.
5. Clean off any polymer build-up (crystals) on the instrument including the capillary tips with deionized water and lint-free tissue.

IMPORTANT! Never use organic solvents to clean the instrument or any of its components.

Moving and Leveling the Instrument

Before Moving the Instrument



WARNING PHYSICAL INJURY HAZARD. Do not attempt to lift the instrument under any circumstances.

To prepare the instrument for moving:

1. Remove the following components from the DNA analyzer:
 - Any plate assemblies from the stacker.
 - Water, waste and buffer reservoirs from the plate deck.
 - Capillary array. For instruction see page 5-13.
 - Polymer reservoir.
 - Syringe from the upper polymer block. For instruction see page 5-20.
 - Upper polymer block and polymer tubing. For instruction see page 5-21.
 - Anode buffer jar.
 - Lower polymer block. For instruction see page 5-21.
2. Switch off the breaker on the back of the instrument.
3. Disconnect the power cord and the Ethernet cable.

IMPORTANT! While moving the instrument, avoid any shock or vibration.

Leveling the Instrument

To level the instrument:

1. Place the bubble level on the autosampler deck.
2. Turn the instrument legs to level the instrument.

To move the instrument corner...	Turn the leg...
up	right (clockwise)
down	left (counterclockwise)

Resetting the Instrument

Overview Reset the instrument when:

- There is a fatal error as indicated by the red status light
- The instrument does not respond to the 3730/3730xl Data Collection software

There are two ways to reset the instrument:

- Press the Reset button on the front of the instrument to dump and reload the firmware and to reset the electronics. Try this method first.
- Shut down and restart the computer and the 3730/3730xl instrument.

Resetting With the Reset Button

To reset the instrument:

1. Close the instrument door.
2. Using a long narrow implement, such as a straightened paper clip, insert into the hole located to the right of the status lights and press the reset button.

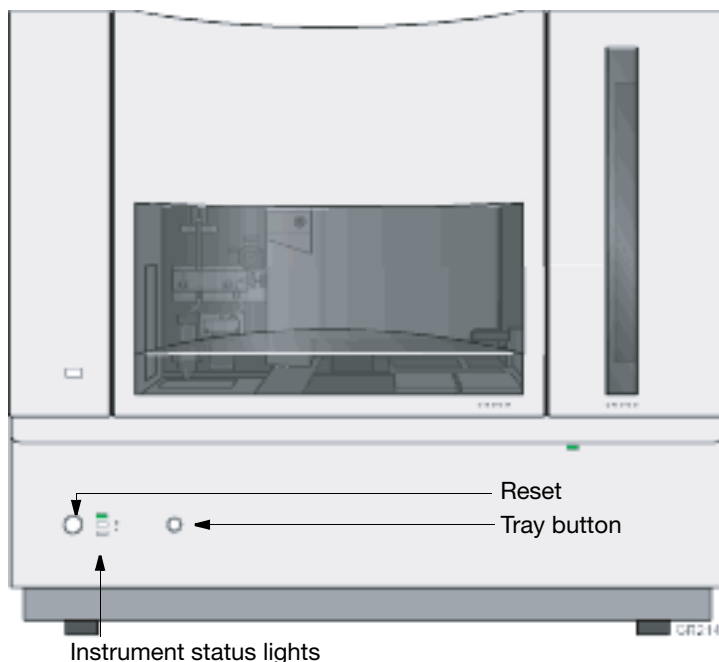

Figure 5-1 Front of Instrument

Resetting by Powering Down

To reset the instrument:

1. Close the instrument door.
2. Turn off the instrument by pressing the on/off button on the front of the instrument.
3. Close all applications.

4. Restart the computer (recommended).
 - a. Select **Start > Shutdown**.
 - b. In the **Shutdown Windows** dialog box, select **Restart** and click **OK**.
5. Turn on the instrument and wait for the solid green light.

Note:

- When the instrument is shut down, the firmware is not saved. Upon restart, the instrument reloads a copy of the firmware and the calibration file from the computer.
 - The buffer tray must be present on the instrument deck before the green light can appear.
6. Launch the Data Collection software (all applications in the Service Console start automatically).

Shutting Down the Instrument

Short- and Long-Term Shutdowns

Perform the appropriate shutdown procedure as follows:

Table 5-4 Shutdown Procedures

If the instrument is be unattended for...	Perform this shutdown procedure...
no more than 1 week with a full buffer reservoir	Short-term IMPORTANT! The key to a successful short-term shutdown is keeping the capillary array in 1X running buffer. This prevents the polymer from drying in the capillaries.
for more than 1 week	Long-term

Performing a Short-Term Shutdown

To perform a short-term shutdown:

1. Ensure the oven and instrument doors are closed.
2. Fill the capillaries with polymer. For instructions, see page 5-22.
3. Push the Tray button to move the buffer reservoir forward.
4. Fill the buffer reservoir with 80 mL of fresh 1X running buffer.
5. Fill other reservoirs with 80 ml of fresh deionized water.
6. Secure a septa and retainer to the reservoirs and place them in the appropriate positions on the autosampler.
7. Close the instrument doors. The autosampler moves the buffer reservoir to the capillary array, leaving the capillary tips in the buffer.
8. Shut down the computer and turn off the instrument.

Performing a Long-Term Shutdown

To perform a long-term shutdown:

1. Follow the procedure on page 5-17 to remove and store the capillary array off the instrument.
2. Remove from the instrument:
 - Syringe from the upper polymer block. For instructions see page 5-20.
 - Upper polymer block. For instructions see page 5-21.
 - Lower polymer block. For instructions see page 5-21.
3. Remove from the autosampler:
 - Plate assemblies
 - Reservoirs
4. Wipe the autosampler and drip trays with lint-free tissue dampened with water.
5. Close the instrument doors.
6. Shut down the computer and turn off the instrument.
7. Wash the syringe, polymer blocks, and reservoirs with warm water. Rinse with deionized water.

IMPORTANT! Make sure all parts are completely dry before long-term storage.

Fluids and Waste

Buffer

When to Change the Buffer We recommend that you change the buffer before each run or at least every 24 hours.

Preparing Buffer To prepare 1 L of 1X running buffer:

1. Add 100 mL of ABI PRISM[®] 10X Running Buffer with EDTA into a graduated cylinder.
2. Add deionized water to bring the total volume up to 1 L.
3. Mix well.

Storing Buffer The 1X running buffer can be stored at 2 to 8 °C for up to 1 month.

Polymer

Storing Polymer Store any remaining 3730/3730xl POP-7[™] polymer at 2 to 8 °C until the expiration date printed on the bottle.

Note: Excessively hot environments may shorten the working life of the polymer.

When to Change the Polymer We recommend that you change the polymer weekly. The polymer is good at 25 °C for about 7 days.

Adding and Changing the Polymer



CAUTION CHEMICAL HAZARD. POP-7 Polymer may cause eye, skin, and respiratory tract irritation. Please read the MSDS, and follow the handling instructions. Wear appropriate protective eyewear, clothing, and gloves. Use for research and development purposes only.

To put fresh polymer on the instrument:

1. Click **Wizards > Change Polymer Wizard**.



2. Follow the directions given in the wizard to put fresh polymer on the instrument.

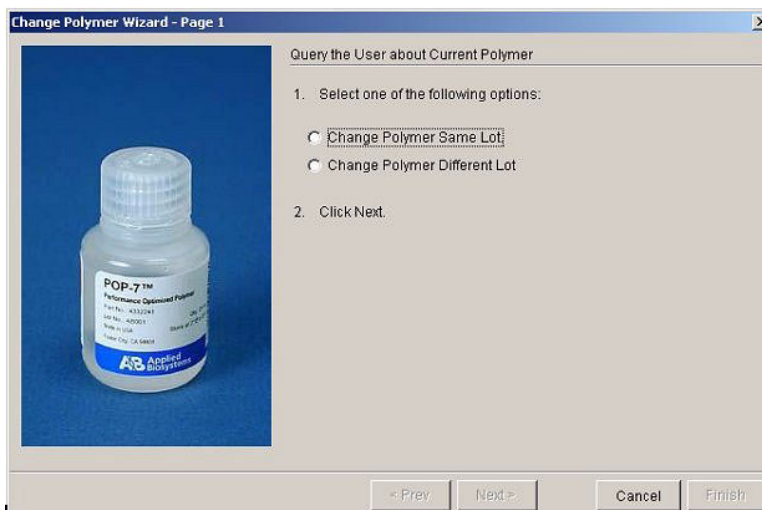

Figure 5-2 Changing the Polymer

Handling Instrument Waste

About Waste Disposal

As the generator of potentially hazardous waste, it is your responsibility to perform the actions listed below.

- Characterize (by analysis if necessary) the waste generated by the particular applications, reagents, and substrates used in your laboratory.
- Ensure the health and safety of all personnel in your laboratory.
- Ensure that the instrument waste is stored, transferred, transported, and disposed of according to all local, state/provincial, or national regulations.

Note: Radioactive or biohazardous materials may require special handling, and disposal limitations may apply.

See also the *Applied Biosystems 3730/3730xl DNA Analyzers Installation Guide* and *Site Preparation and Safety Guide*.

POP-7 Polymer



CAUTION

CHEMICAL HAZARD. POP-7 Polymer causes eye, skin, and respiratory tract irritation. Read the MSDS, and follow the handling instructions. Wear appropriate protective eyewear, clothing, and gloves.

Capillary Array

Before Installing a Capillary Array

Introduction Before you reinstall a capillary array, it is recommended that you:

- Clean the front of the detection cell
- Check that the cathode bar is dry

Cleaning the Detection Cell This procedure is unnecessary for new arrays unless you have accidentally touched the detection cell.

To clean the detection cell:

1. Apply a few drops of 100% methanol to a clean cotton-tipped swab.
2. Gently swab the surface of the cell in one direction.
3. Use short bursts of clean pressurized air to dry the cell.

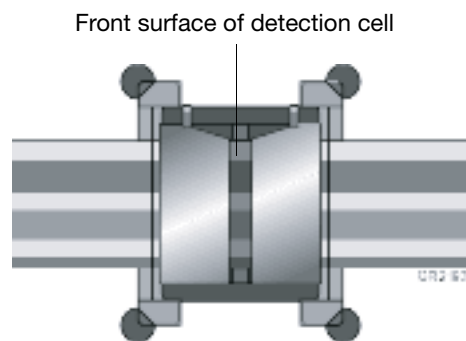



Figure 5-3 Detection Cell

 **WARNING CHEMICAL HAZARD.** Methanol is a flammable liquid and vapor. Exposure may cause eye, skin, and respiratory tract irritation, and central nervous system depression and blindness. Please read the MSDS, and follow the handling instructions. Wear appropriate protective eyewear, clothing, and gloves.

Installing and Removing a Capillary Array

When to Change a Capillary Array

A capillary array should last 300 runs.

The following problems may indicate that a new capillary array is required:

- Poor resolution and/or decreased signal intensity
- Poor sizing precision or allele calling (GeneMapper<Instrument Name> or, GeneMapper-Generic applications)

Installing or Removing the Capillary Array Using the Wizard

IMPORTANT! Wear gloves while performing the following procedure, and any time you handle the capillary array, glass syringes, septa, buffer reservoirs, polymer bottles, polymer blocks, interconnect tubing, and bottle cap tubing.

IMPORTANT! You must use the capillary array wizard when installing a new capillary array as KB Basecaller selects the proper calibration/mobility based on the instrument wizard-installed capillary settings. The incorrect capillary settings may result in KB Basecaller using incorrect calibration files.



CAUTION

CHEMICAL HAZARD. POP-7 polymer may cause eye, skin, and respiratory tract irritation. Please read the MSDS, and follow the handling instructions. Wear appropriate protective eyewear, clothing, and gloves. Use for research and development purposes only.

Installing a New Capillary Array

To install a new capillary array:

1. With the instrument door closed, press the tray button to ensure that the buffer tray is in its proper position.
2. Click **Wizards > Install Capillary Array Wizard**.

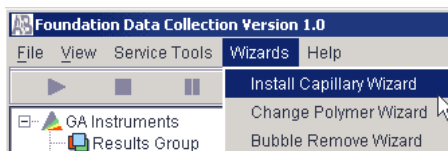

- Follow the directions in the Wizard. Each picture in the process follows below.

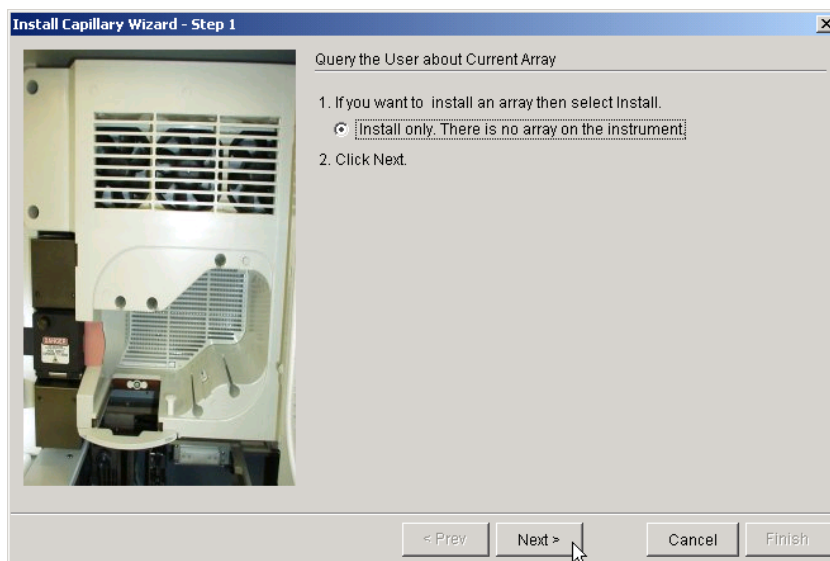

- Click **Next**.

The next Wizard window displays

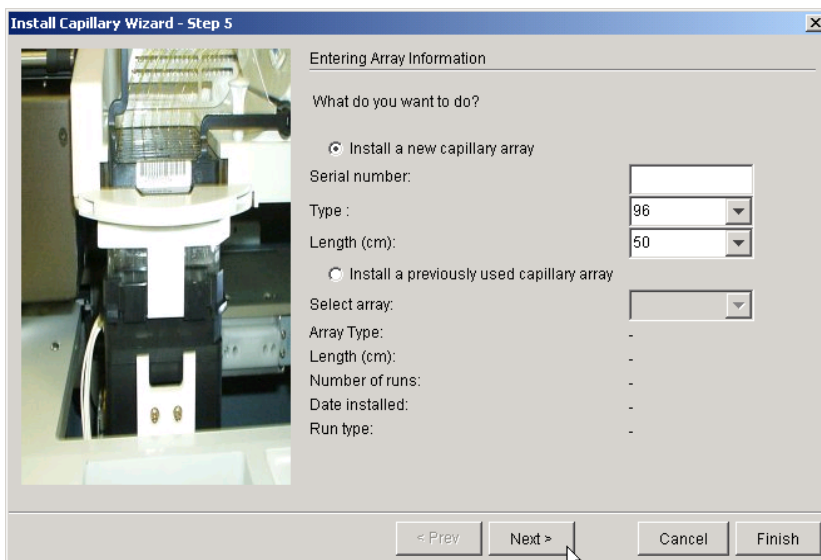

- Select **Install a new capillary array**.
- Enter the capillary array serial number.
- From the **Type** list, select 48 or 96.
- From the **Length (cm)** list, select 36 or 50.
 - Click **Next** continue to the end of the wizard.
 - Click **Cancel** to exit the wizard. Capillary information is not saved.
 - Click **Finish** to save the serial number, capillary array type, and capillary array length.

Removing an Array for Storage

To remove the array for long- or short-term storage:

1. With the instrument door closed, press the tray button to ensure that the buffer tray is in its proper position.
2. Click **Wizards > Install Capillary Array Wizard**.
3. Follow the wizard's instructions.

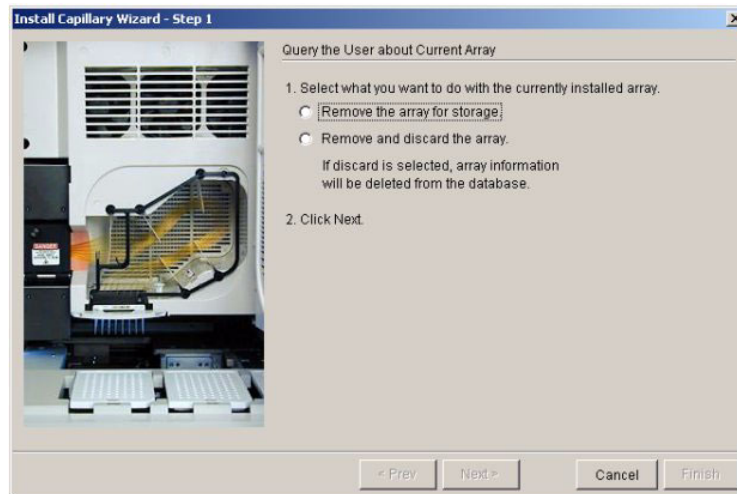

Capillary Array Maintenance

Caring for the Capillary Array

Follow these guidelines to properly care for the capillary array:

- Wear gloves and handle the capillary array gently.
- Do not touch the detection cell. If it is dirty, see “Cleaning the Detection Cell” on page 5-12.
- Keep the ends of the capillary array wet at all times.
- Always loosen the capillary array knob before pulling out the upper polymer block.
- Do not overtighten the capillary array knob.

Cleaning the Capillary Array

To clean the capillary array:

1. Flush the capillary array with fresh polymer as instructed in the “Installing and Removing a Capillary Array” on page 5-13.
2. Clean off any polymer buildup (crystals) on the instrument, including the capillary electrodes with deionized water and lint-free tissue.

Note: When cleaning the capillary electrodes, be careful not to bend them out of position.

IMPORTANT! Never use organic solvents to clean the instrument or any of its components.

3. Clean the detection cell as instructed on page 5-12.

Storing a Capillary Array on the Instrument

Overview

Store the capillary array on the instrument when the capillary array is to be unused for less than 1 week.

Storing the Array on the Instrument

To store the capillary array on the instrument, follow the instructions to perform a short-term shutdown on page 5-7.

Storing a Capillary Array off the Instrument

Overview Store the capillary array off of the instrument when the capillary array is to be unused for longer than 1 week.

Before storing the capillary array for long periods, we recommend filling the capillaries with fresh polymer.

Storing the Capillary Array off the Instrument

IMPORTANT! If you intend to reuse the capillary array, do not let the capillaries dry out. Store the capillary array with both ends in fresh 1X running buffer.

IMPORTANT! Wear gloves while performing the following procedure, and any time you handle the capillary array, glass syringes, septa, buffer reservoirs, polymer bottles, polymer blocks, interconnect tubing, and bottle cap tubing.

To store the capillary array off the instrument:

1. Remove the capillary array from the instrument using the Install/Replace Capillary Array wizard (see page 5-13).
2. Replace the cover over the detection cell.
3. Fill the buffer container that comes packaged with the capillary array.
4. Fill the header shipping cover with fresh 1X running buffer and insert the capillary tips into the header shipping cover.
5. Fill the shipping vial with fresh 1X running buffer and insert the detection end of the capillary array, tighten the cap to ensure an airtight O-ring seal.
6. Store the capillary array upright in the shipping container.
7. Check the 1X running buffer level in the reservoir and tube weekly.

Syringes

Syringe Maintenance

Caring for Syringes

IMPORTANT!

- To extend the lifetime of the syringe plunger's Teflon fitting, place a drop of deionized water on the plunger's end before moving the plunger in the barrel.
- Do not mix the barrels and plungers from different syringes. Mixing and matching is a common cause of leaks.
- Wear gloves while handling the glass syringes.

Replacing the Syringe

To maintain optimal performance, we recommend that you replace syringes approximately every 3 months.

Cleaning Syringe

Thoroughly clean the syringes:

- Whenever they are removed from the instrument, or at least once per week
- Each time the polymer is replaced, including when switching to a new type or lot of polymer

IMPORTANT! Wear gloves while performing the following procedure, and any other time you handle the capillary array, glass syringes, septa, or buffer reservoirs.

To clean a syringe:

1. Remove the syringes as described on page 5-20.
2. Clean the syringe thoroughly by rinsing the inside and outside of the syringe barrel and the syringe tip with warm, deionized water (≤ 70 °C).

IMPORTANT! Be sure there is no dried polymer left in the syringes.

3. Rinse the syringe barrel and tip with deionized water.
4. Reassemble the syringe and then inspect it as described below.

IMPORTANT! Do not dispense/aspirate faster than a 5-count (example, "one thousand one...one thousand two...one thousandthree..." etc.) as doing so damages the teflon tip.

Inspecting a Syringe

IMPORTANT! After cleaning a syringe, always inspect for missing O-rings to avoid leaks during a run.

To inspect the syringe:

1. Inspect the syringe for two O-rings (P/N 221102): one behind the ferrule and one around the ferrule.

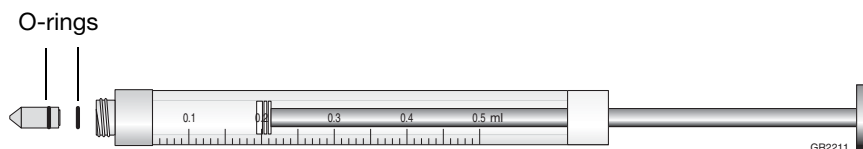

2. Verify that the ferrule is firmly seated in the end of the syringe.

Priming and Filling Syringe

Priming and Filling the Polymer Syringe

Follow the procedure below after cleaning the polymer syringe



CAUTION

CHEMICAL HAZARD. POP polymer may cause eye, skin, and respiratory tract irritation. Please read the MSDS, and follow the handling instructions. Wear appropriate protective eyewear, clothing, and gloves. Use for research and development purposes only.

IMPORTANT! Wear gloves while performing the following procedure, and any other time you handle the capillary array, glass syringes, septa, or buffer reservoirs.

To prepare the polymer-reserve syringe for use:

1. Draw approximately 0.3 mL of room-temperature polymer into a clean polymer-reserve syringe.
2. Pull up the plunger to the 500 μ L mark.
3. Invert the syringe about six times to coat the walls with polymer. Discard this polymer into aqueous waste.

Note: Priming the syringe ensures that the running polymer is at the intended concentration and not diluted by residual water.

4. Fill the polymer syringe with a maximum of 500 μ L of polymer.

IMPORTANT! Avoid introducing air bubbles into the polymer by keeping the syringe tip just submerged in the polymer while aspirating gently.

5. Remove any air bubbles by inverting the syringe and pushing a small amount of polymer out of the tip.

Note: Do not return the unused portion of the polymer to the bottle.

Installing and Removing Syringe

Installing Syringe To install the syringe:

1. Follow the procedures to remove, clean, and dry the upper polymer block starting on page 5-25.
2. Place the syringe tip into the top port of the upper polymer block and screw the syringe clockwise into the polymer block.

IMPORTANT! Always hold the syringe by the metal sleeve—not the glass—when screwing the syringe into the block.

The syringe should be finger tight in the block.

3. Push the polymer block all the way against the instrument.

Removing Syringe To remove the syringes from the upper polymer block:

1. Grasp the polymer syringe at the base (not the glass barrel) and rotate the syringe counterclockwise.

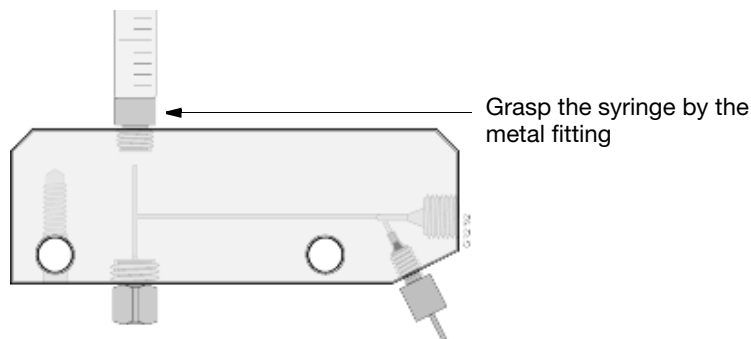

Figure 5-4 Removing Syringes from the Upper Block

2. Dispose of any remaining polymer properly.
3. Proceed to “Syringe Maintenance” on page 5-18.

Polymer Blocks

Removing the Polymer Blocks Together

If the capillary array is to be reused, store it as described on page 5-16.



WARNING CHEMICAL HAZARD. POP polymer may cause eye, skin, and respiratory tract irritation. Please read the MSDS, and follow the handling instructions. Wear appropriate protective eyewear, clothing, and gloves. Use for research and development purposes only.

IMPORTANT! Wear gloves while performing the following procedures, and any other time you handle the capillary array, glass syringes, septa, polymer blocks, or buffer reservoirs.

To remove the polymer blocks together:

1. Disconnect the capillary array from the polymer block:
 - a. Press the Tray button (instrument door must be closed).
 - b. Open the instrument, oven, and detection block doors.
 - c. Flip the detection cell locking lever to the left and up.



CAUTION Failure to perform step c. above before step d. below, can result in a broken detection cell.

- d. Pull out both polymer blocks part way.
 - e. Loosen the capillary array knob.
2. Remove the capillary array sleeve from the polymer block.
3. Remove the syringe as described on page 5-20.
4. Remove the anode reservoir by slightly rotating it while pulling down. Dispose of the buffer properly.
5. Grasp the upper and the lower polymer blocks at the same time and pull them straight out.
 - The upper polymer block rides on two steel shafts (guide pins) and slides out easily after a ball plunger moves past a check point.
6. Disconnect the lower polymer block by unscrewing the polymer block interconnecting tube fitting from the lower polymer block.
7. Remove the polymer cap tube assembly from the check valve. Be sure not to remove the check valve from the upper polymer block.

Cleaning the Polymer Blocks

Frequency Clean the upper and lower polymer blocks:

- Before replacing the polymer on the instrument
- When the polymer has been on the instrument for longer than 1 week

Note: Polymer older than 1 week may cause a transient increase in current during electrophoresis due to urea decomposition.

Cleaning the Upper Polymer Block

IMPORTANT! Do not expose the polymer blocks to any organic solvents.

Below is a picture of the upper polymer block with the syringe and syringe adaptor attached.

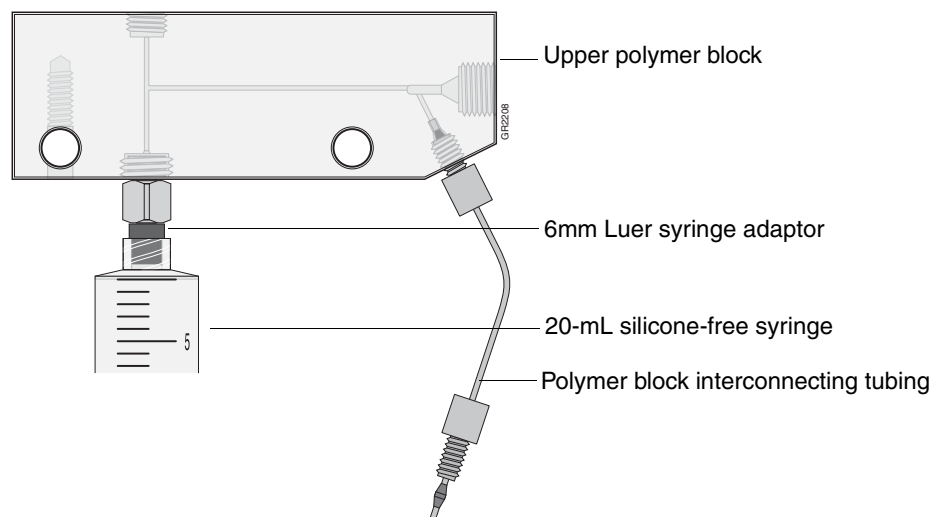

Figure 5-5 Elements of the Upper Polymer Block

To clean the upper polymer block:

1. Fill the 20-mL silicone-free syringe (P/N 4324463) with warm deionized water (≤ 70 °C).
IMPORTANT! Do not use water > 70 °C.
2. Fit the 6-mm Luer syringe adaptor (P/N 4322928) onto the 20-mL syringe.
3. Thread the 6-mm Luer syringe adaptor into the stainless-steel check valve.
4. Force several syringe loads of warm deionized water through each channel in turn by sealing their openings with your fingers.
5. Force deionized water through polymer block tubing.
6. Inspect the channels visually for dried polymer, visible as white residue. Wash partially occluded channels with warm deionized water until the dried polymer is gone.

IMPORTANT! It may take a long time for the warm water to clear the obstruction. Do not use a sharp pointed instrument to clear the channel, even if the channel is completely occluded with dried polymer.

7. After washing, rinse the upper polymer block and all the fittings thoroughly using deionized water.
8. After rinsing, follow the table below:

If...	Then...
You are not placing the upper polymer block immediately on the instrument after cleaning	Leave it in a beaker of deionized water until you are ready to use it.
You are placing the upper polymer block on the instrument directly after cleaning	Shake the water out of the channels and install it on the instrument. Note: during the priming cycle of the wizard, any remaining deionized water is flushed out with fresh polymer.

IMPORTANT!

- Do not use canned compressed air to dry polymer blocks.
- Do not use the 500- μ L glass syringe to force air through the channels. This damages the syringe plunger and causes the syringe to leak.

Cleaning the Lower Polymer Block

Below is a picture of the lower polymer block with the syringe and syringe adaptor attached.

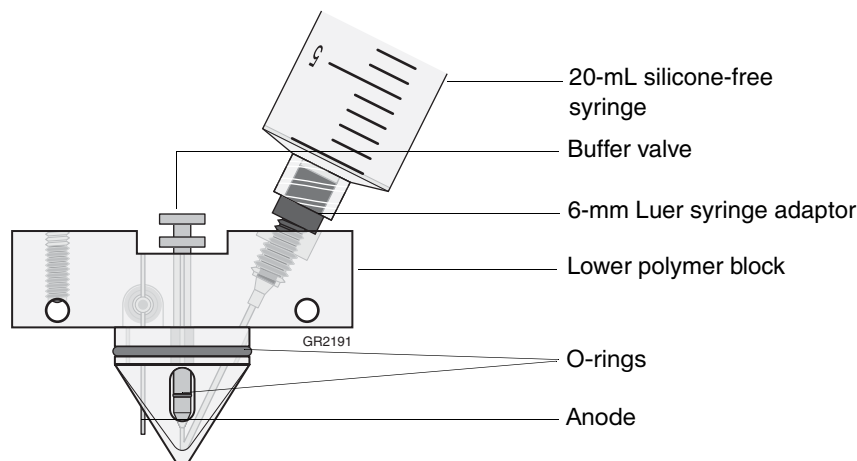

Figure 5-6 Elements of the Lower Polymer Block

To clean the lower polymer block:

1. Rinse all the fittings with warm, deionized water (≤ 70 °C). Soak any fittings that are covered with polymer.

IMPORTANT! Do not use water > 70 °C to rinse the fittings or the polymer block.

2. Hold the lower polymer block under warm, deionized water (≤ 70 °C). Using your fingers, move the buffer valve in and out to ensure any encrusted polymer is cleaned out of its guide channel.

IMPORTANT! Do not remove any of the components from the lower polymer block.

3. Fit the 6-mm Luer syringe adaptor (P/N 4322928) onto the 20-mL silicone-free syringe (P/N 4324463).
4. Thread the 6-mm Luer syringe adaptor into the polymer block where the polymer block tube fitting was originally located.
5. Force several syringe loads of warm deionized water through the channel.
6. Inspect the channels visually for dried polymer, which is white residue. Wash partially occluded channels with warm deionized water until the dried polymer is gone.

IMPORTANT! It may take a long time for the warm water to clear the obstruction. Do not use a sharp pointed instrument to clear the channel, even if the channel is completely occluded with dried polymer.

7. After washing, rinse the lower polymer block and all the fittings thoroughly using deionized water.
8. After rinsing, follow the table below:

If...	Then...
You are not placing the upper polymer block immediately on the instrument after cleaning	Leave it in a beaker of deionized water until you are ready to use it.
You are placing the upper polymer block on the instrument directly after cleaning	Shake the water out of the channels and install it on the instrument. Note: during the priming cycle of the wizard, any remaining deionized water is flushed out with fresh polymer.

Re-installing the Upper and Lower Polymer Blocks

Re-installing the Polymer Blocks

To re-install the polymer blocks to the instrument:

1. Clean the polymer blocks and the tubing as instructed on page 5-25.
2. Connect the tubing between the two blocks before attaching the blocks to the instrument:
 - a. Insert one ferrule into the upper polymer block and rotate clockwise until finger tight.
 - b. Insert the other ferrule into the lower polymer block and rotate clockwise until finger tight.

IMPORTANT! To ensure that you are correctly attaching the upper polymer block to the instrument, make sure that the check valve on the bottom of the block is facing down (as shown below).

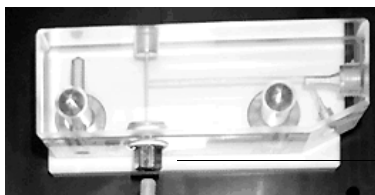

Check valve at bottom of the upper block, facing down toward the lower block.

Figure 5-7 Upper Polymer Block Check Valve

3. Do not overtighten.
4. Push the upper polymer block and the lower polymer block onto their respective guide pins at the same time (as shown below). Push both blocks at the same time, about half way down the guide pins, toward the instrument wall.

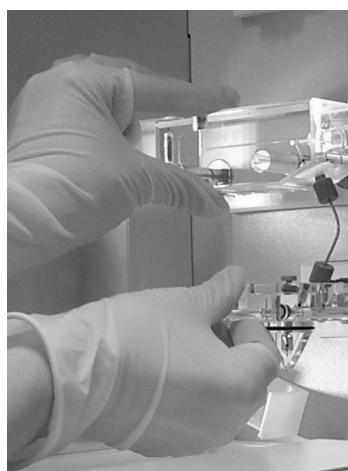
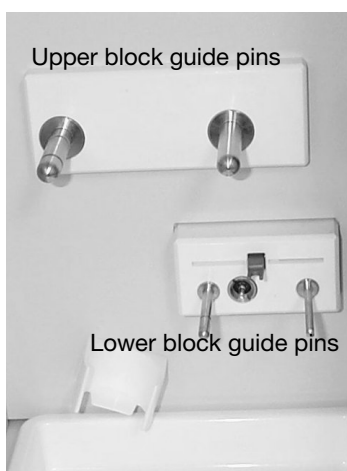

Push both blocks at the same time, about half way down the guide pins, toward the instrument wall.

Figure 5-8 Attaching The Blocks To The Instrument

5. Finish by pushing each block, individually, until each is flush against the instrument wall (as shown below).

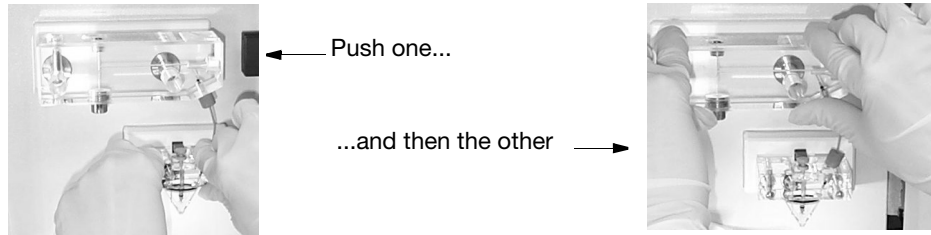

6. Install a clean drip tray.

⚠ WARNING An air gap between the polymer tubing and the stop may cause arcing.

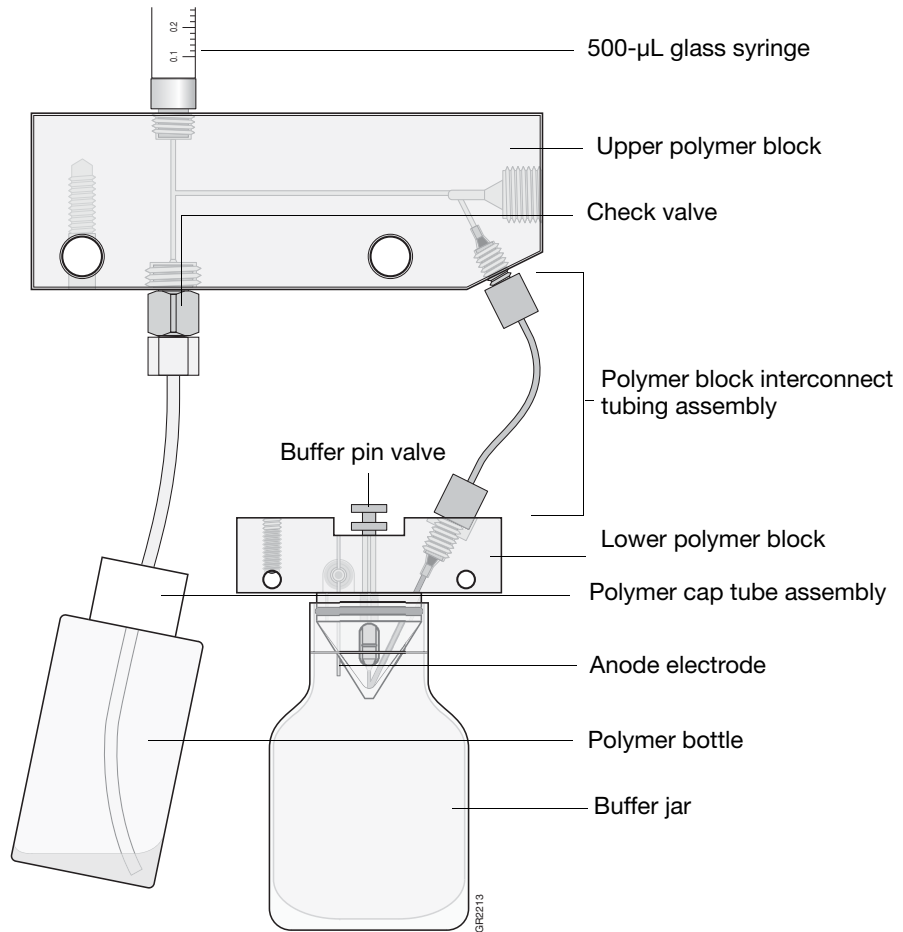

Figure 5-9 Upper and Lower Polymer Blocks

Removing Air Bubbles from the Upper Polymer Block

Removing Air Bubbles

You can remove air bubbles two ways:

- Using the Bubble Remove wizard
- Manually

Removing Air Bubbles Using the Wizard

To remove air bubbles from the upper block using the wizard:

1. **Click Wizards > Bubble Remove Wizard.**

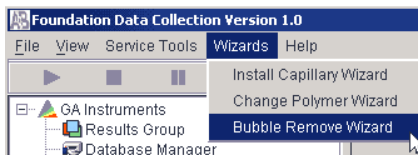

2. Follow the instructions in the wizard.

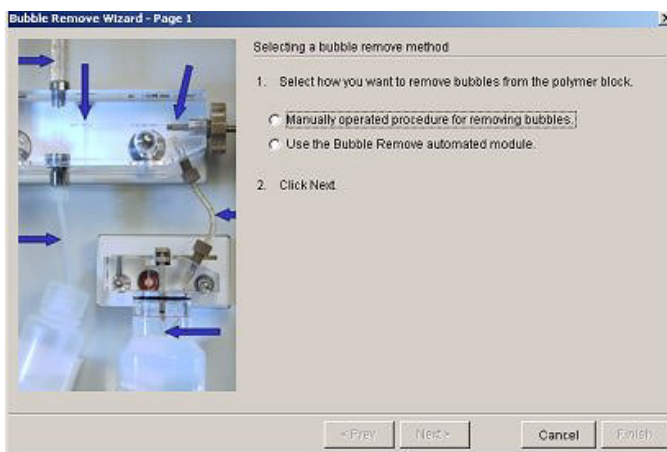

Manually Removing Air Bubbles

To manually remove air bubbles from the upper block:

1. Push down on the syringe to move bubbles to the lower block. Push slowly (or tap) to minimize the amount of polymer used.
2. Push down slowly on the syringe to move bubbles down the channel. The bubbles collect where the channels join.

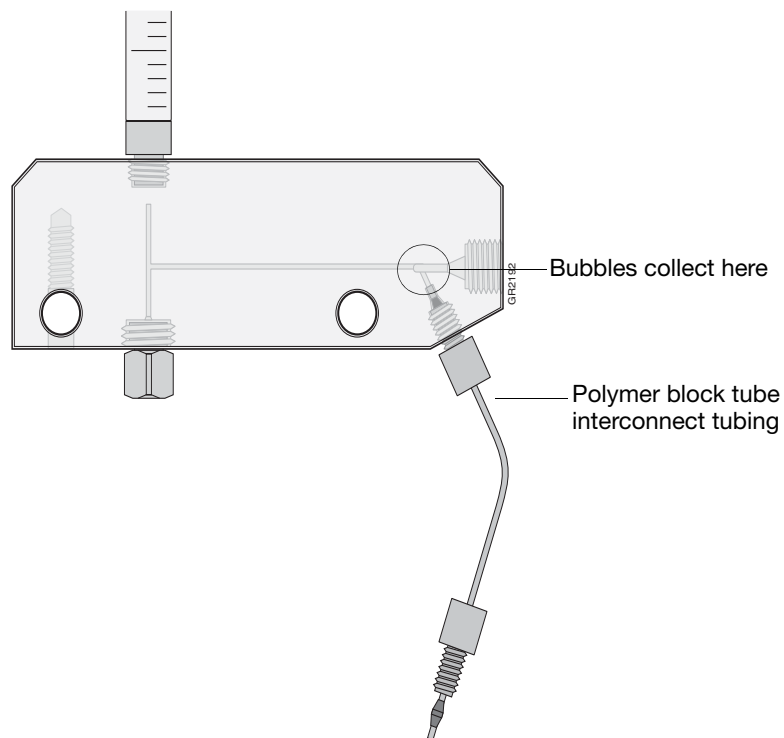

Figure 5-10 Where Bubbles May Collect

3. Expel bubbles into the lower block:
 - a. Hold down the anode buffer pin valve and simultaneously push down on the syringe to build pressure in the channels.
 - b. Release the buffer pin valve (while still pressing down on the syringe) to expel bubbles into the lower block.

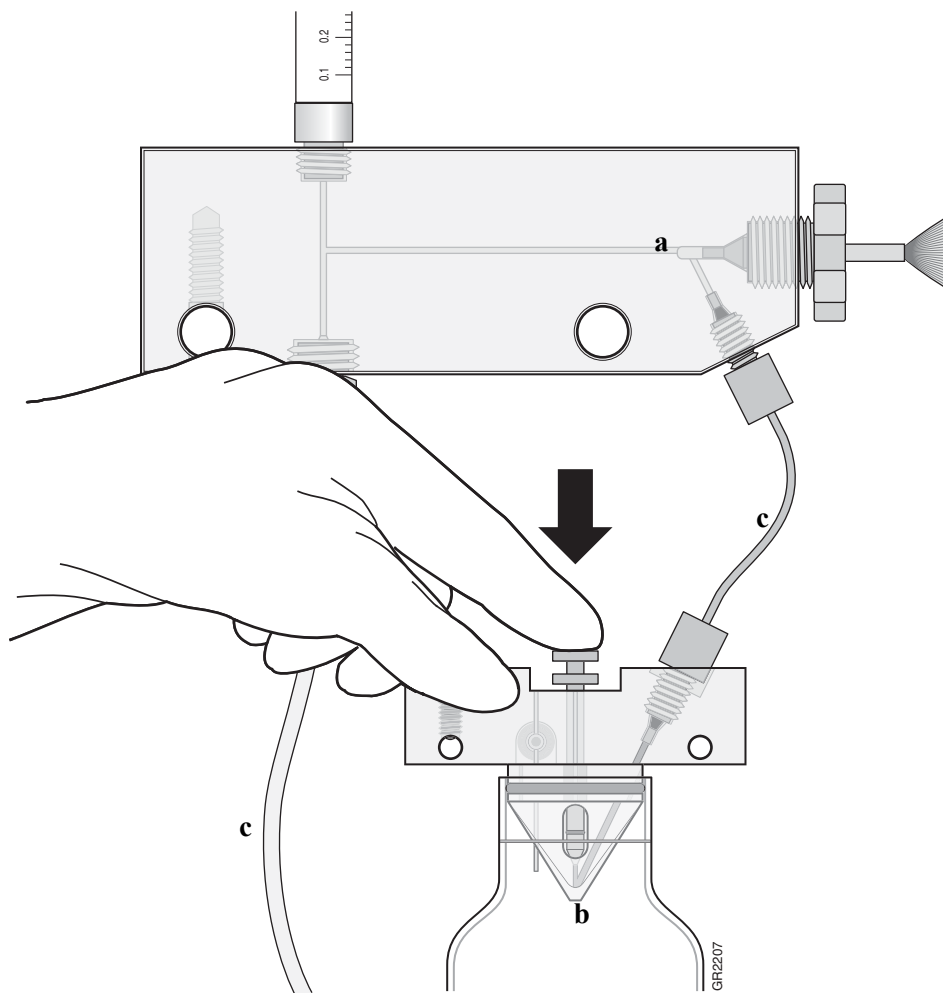

Figure 5-11 Watch for bubbles:
a. At the array ferrule tip
b. In the elbow of the lower block
c. In all tubing

Checking Available Space on Drives D, E, and F

Overview Before a run or batch of runs, the Data Collection software automatically checks the available space to ensure sufficient space to store the database and sample file data you create.

3730/3730xl Files Drive E The Data Collection software send a warning message to remove data when the drive E is getting full. The following dialog box is displayed.



Runs can not be started until the data is removed from the drive.

Database Drives D and E The Data Collection software sends a warning message to clean up the database when the database is getting full (~80% of capacity). The following dialog box is displayed.

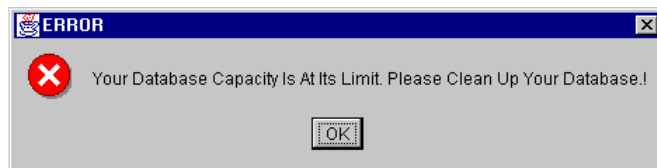

Runs can not be started until the database is cleaned up.

Cleaning Drives Ensure that you have sufficient drive space by regularly:

- Archiving Data
- Deleting unneeded files
- Emptying the trash

Hard Disk Status

Checking Available Disk Space

To check the disk space status:

1. Click the + box next to the GA Instruments icon to expand the tree pane.
2. Click the **Database Manager** icon.

The Database Manager view opens.

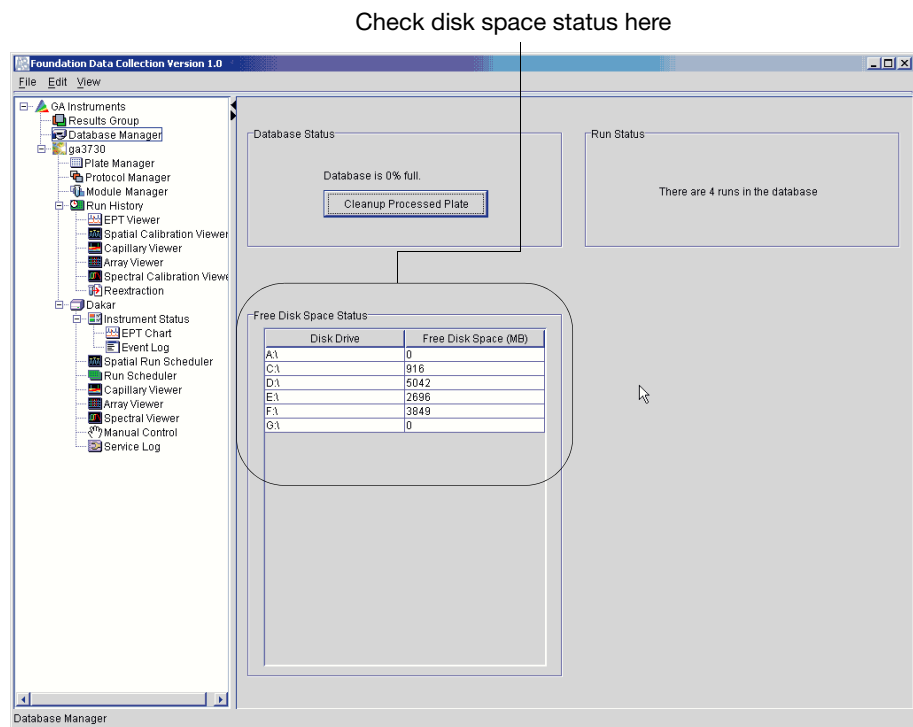

Table 5-5 Checking available drive space

3. If there is insufficient space:
 - Archive the sample files to a CD-RW or another volume.

Deleting Records from the Database

Deleting Processed Frame Data



CAUTION The Cleanup Database utility deletes all run data and plate records in the database. Before running the utility, be sure that all runs have been extracted from the database.

To delete processed frame data from the database:

1. Click the + box next to the GA Instruments icon to expand the tree pane.
2. Click the **Database Manager** icon.

The Database Manager view opens.

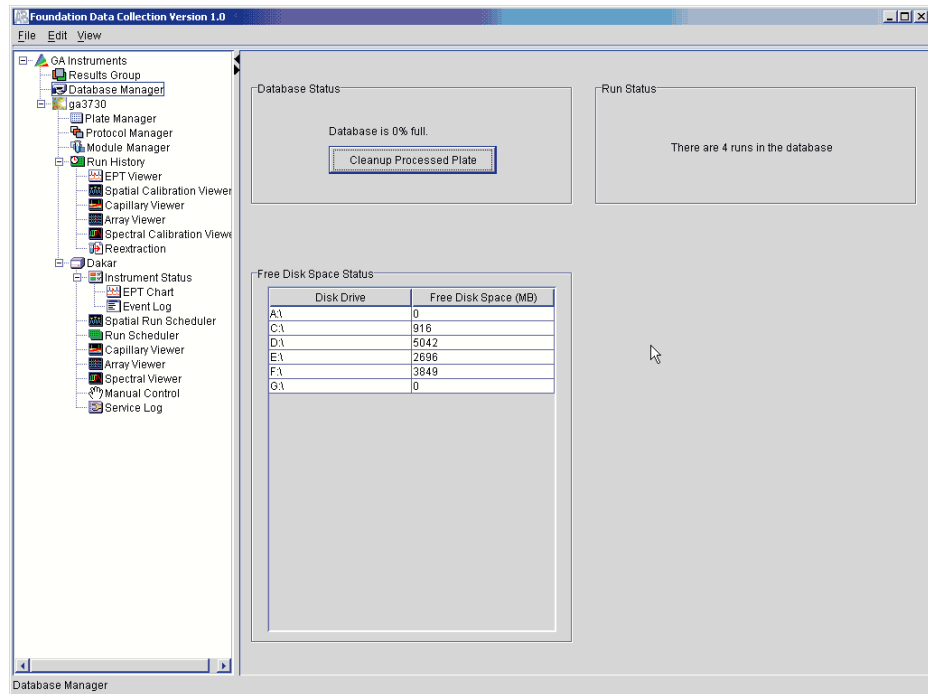
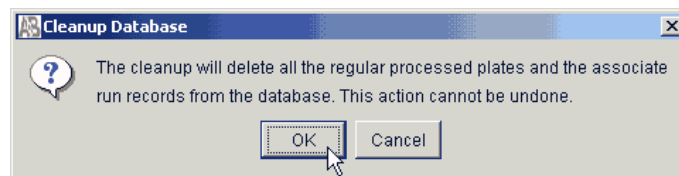

Figure 5-11 Database Manager Window

3. Click **Cleanup Processed Data**.

The following dialog box opens.



4. Click **OK**.

Note: There is no need to re-import the spatial, spectral, and run calibration methods or the calibration data obtained from the last calibration runs.

**Deleting an
Individual Plate
Record
Reference**

Delete individual plate records when you want to free database space without deleting all of the records.

Warranty and Service Information

A

In This Appendix	Computer Configuration	A-2
	Limited Product Warranty	A-2
	Damages, Claims, Returns	A-4

Computer Configuration

Applied Biosystems supplies or recommends certain configurations of computer hardware, software, and peripherals for use with its instrumentation.

Applied Biosystems reserves the right to decline support for or impose extra charges for supporting nonstandard computer configurations or components that have not been supplied or recommended by Applied Biosystems. Applied Biosystems also reserves the right to require that computer hardware and software be restored to the standard configuration prior to providing service or technical support. For systems that have built-in computers or processing units, installing unauthorized hardware or software may void the Warranty or Service Plan.

Limited Product Warranty

Limited warranty Applied Biosystems warrants that all standard components of its 3730/3730xl DNA Analyzers will be free of defects in materials and workmanship for a period of one (1) year from the date the warranty period begins. Applied Biosystems will repair or replace, at its discretion, all defective components during this warranty period. After this warranty period, repairs and replacement components may be purchased from Applied Biosystems at its published rates. Applied Biosystems also provides service agreements for post-warranty coverage. Applied Biosystems reserves the right to use new, repaired, or refurbished instruments or components for warranty and post-warranty service agreement replacements. Repair or replacement of products or components that are under warranty does not extend the original warranty period.

Applied Biosystems warrants that all optional accessories supplied with its 3730/3730xl DNA Analyzers, such as peripherals, printers, and special monitors, will be free of defects in materials and workmanship for a period of ninety (90) days from the date the warranty begins. Applied Biosystems will repair or replace, at its discretion, defective accessories during this warranty period. After this warranty period, Applied Biosystems will pass on to the buyer, to the extent that it is permitted to do so, the warranty of the original manufacturer for such accessories.

With the exception of consumable and maintenance items, replaceable products or components used on or in the instrument are themselves warranted to be free of defects in materials and workmanship for a period of ninety (90) days.

Applied Biosystems warrants that chemicals and other consumable products will be free of defects in materials and workmanship when received by the buyer, but not thereafter, unless otherwise specified in documentation accompanying the product.

Applied Biosystems warrants that for a period of ninety (90) days from the date the warranty period begins, the software designated for use with the product will perform substantially in accordance with the function and features described in its accompanying documentation when properly installed on the product for which it is designated, and that for a period of ninety (90) days from the date the warranty period begins, the tapes, diskettes, or other media bearing the software product will be free of defects in materials and workmanship under normal use.

Applied Biosystems will provide any software corrections or “bug-fixes,” if and when they become available, for a period of ninety (90) days from the date the warranty period begins. Applied Biosystems does not warrant that the operation of the instrument or software will be uninterrupted or error free.

Warranty period effective date Any applicable warranty period under these sections begins on the earlier of the date of installation or ninety (90) days from the date of shipment for hardware and software installed by Applied Biosystems personnel. For all hardware and software installed by the buyer or anyone other than Applied Biosystems, and for all other products, the applicable warranty period begins the date the product is delivered to the buyer.

Warranty claims Warranty claims must be made within the applicable warranty period, or, for chemicals or other consumable products, within thirty (30) days after receipt by the buyer.

Warranty exceptions The above warranties do not apply to defects resulting from misuse, neglect, or accident, including without limitation: operation with incompatible solvents or samples in the system; operation outside of the environmental or use specifications or not in conformance with the instructions for the instrument system, software, or accessories; improper or inadequate maintenance by the user; installation of software or interfacing, or use in combination with software or products, not supplied or authorized by Applied Biosystems; and modification or repair of the product not authorized by Applied Biosystems.

The foregoing provisions set forth Applied Biosystems' sole and exclusive representations, warranties, and obligations with respect to its products, and Applied Biosystems makes no other warranty of any kind whatsoever, expressed or implied, including without limitation, warranties of merchantability and fitness for a particular purpose, whether arising from a statute or otherwise in law or from a course of dealing or usage of trade, all of which are expressly disclaimed.

Warranty limitations The remedies provided herein are the buyer's sole and exclusive remedies. Without limiting the generality of the foregoing, in no event shall Applied Biosystems be liable, whether in contract, tort, warranty, or under any statute (including without limitation, any trade practice, unfair competition, or other statute of similar import) or on any other basis, for direct, indirect, punitive, incidental, multiple, consequential, or special damages sustained by the buyer or any other person or entity, whether or not foreseeable and whether or not Applied Biosystems is advised of the possibility of such damages, including without limitation, damages arising from or related to loss of use, loss of data, failure or interruption in the operation of any equipment or software, delay in repair or replacement, or for loss of revenue or profits, loss of good will, loss of business, or other financial loss or personal injury or property damage.

No agent, employee, or representative of Applied Biosystems has any authority to modify the terms of this Limited Warranty Statement or to bind Applied Biosystems to any affirmation, representation, or warranty concerning the product that is not contained in this Limited Warranty Statement, and any such modification, affirmation, representation, or warranty made by any agent, employee, or representative of Applied Biosystems will not be binding on Applied Biosystems, unless in a writing signed by an executive officer of Applied Biosystems.

This warranty is limited to the buyer of the product from Applied Biosystems and is not transferable.

Some countries or jurisdictions limit the scope of or preclude limitations or exclusion of warranties, of liability, such as liability for gross negligence or wilful misconduct, or of remedies or damages, as or to the extent set forth above. In such countries and jurisdictions, the limitation or exclusion of warranties, liability, remedies or damages set forth above shall apply to the fullest extent permitted by law, and shall not apply to the extent prohibited by law.

Damages, Claims, Returns

- Damages** If shipping damage to the instrument is discovered, contact the shipping carrier and request inspection by a local agent. Secure a written report of the findings to support any claim. Do not return damaged goods to Applied Biosystems without first securing an inspection report and contacting Applied Biosystems Technical Support for a Return Authorization (RA) number.
- Claims** After a damage inspection report is received by Applied Biosystems, Applied Biosystems will process the claim unless other instructions are provided.
- Returns** Do not return any material without prior notification and authorization.
- If for any reason it becomes necessary to return material to Applied Biosystems, contact Applied Biosystems Technical Support or your nearest Applied Biosystems subsidiary or distributor for a return authorization (RA) number and forwarding address. Place the RA number in a prominent location on the outside of the shipping container, and return the material to the address designated by the Applied Biosystems representative.

Error Messages

B

Overview This appendix lists all error messages, what they mean, and what you can do to address them.

In This Appendix Error MessagesB-2

Error Messages

These error messages originate from publishIFCError() method calls in the indicated java classes.

The following errors were found in **PreProcessingStateDakar.java**

Error Message	Description	Resolution
Can't run plate, no barcode.	There is no plate id available in manual mode.	Reschedule this plate
Container Scheduling Failed	Plate was not run because scheduling for this plate failed.	Reschedule this plate
Batch Validation Failed	Plate was not run because batch validation failed.	Reschedule this plate
Container and numCap validation failed	Plate was not run because the container and capillary number validation failed.	Possible hardware problem; restart the Data Collection application
Disk drive containing the .EPF file is full	Plate was not run because the disk drive containing the .EPF file is full.	Remove unneeded sample and run files, clean-up the database and try run again.
Error getting plate info from database	Plate not run because error occurred while retrieving plate info from database.	Restart the data and instrument service applications, and then restart the Data Collection software.
Sealing type set by user (from DB) or actual (from instrument) equals null	Validation failed: Sealing type specified by the user in the database or the actual sealing type retrieved from the instrument is null.	Possible instrument hardware problem. Database may be corrupted. Reset up the plate sealing parameter
Sealing type (from instrument) does not match type set by user	Sealing type from the instrument does not match the type set by user.	Possible instrument hardware problem. Database may be corrupted. Reset up the plate sealing parameter.
Validation failed: number of capillaries (from instrument) does not match number set by user.	Validation failed because the number of wells read from the instrument does not match the well count set by the user.	Possible instrument hardware problem. Database may be corrupted. Reset up the plate.
Validation failed: number of wells (from instrument) does not match number set by user.	Validation failed because the number of capillaries read from the instrument does not match the capillary count set by the user.	Possible instrument hardware problem. Database may be corrupted. Reset up the plate.

The following error was found in **InstSideDiagnosticsReader.java**,
in **InstSideEventReader.java**, and in **DataProducer.java**

Error Message	Description	Resolution
Diagnostics port gone offline	The diagnostic port has gone offline because the 'Received Channel' status is offline	Reset the instrument and re-launch Data Collection Data Collection Software

The following errors were found in **RunScheduler.java**

Error Message	Description	Resolution
Container is already linked with instrument	This capillary array is already linked with the instrument.	Restart the instrument service module and re-launch the Data Collection software
Unknown error	This occurs when the source of the error is unknown	None; this is an internal warning message

The following errors were found in **ErrorRecoveryState.java**

Error Message	Description	Resolution
Application Server Has Failed, Software Restart Required	The application server (JBoss) has failed, Software restart is required	Restart the data and instrument service modules then re-launch Data Collection software
Data Processor Stalled, CPU may be over-taxed, Software Restart Required	Data Processor Stalled, software restart is required	Restart the instrument service module then re-launch Data Collection software

The following error was found in **PostBatchState.java** and in **PreBatchState.java**

Error Message	Description	Resolution
Exception reading service module, returning to idle state	Unclear as to what this message is	Restart the data and instrument service modules then re-launch the Data Collection software

The following errors were found in **PreProcessingState.java**

Error Message	Description	Resolution
Exception reading service module, returning to idle state	Unclear as to what this message is	Restart the data and instrument service modules then re-launch the Data Collection software
No pending runs found	Validation is done to the transition the run sets from 'pending' to 'validated'. When this validation fails, this error is produced	None; this is an internal warning message

Index

Numerics

- 3730 2-2
- 3730/3730xl DNA Analyzer Data Collection Software 2-2
- 384-well plate assembly with heat-sealed plate 1-7
- 96-well plate assembly with septa 1-6

A

- About This Guide vii
- air bubbles, clearing 5-27
- Analysis Protocol
 - deleting 2-36
 - editing 2-35
 - working with 2-28
- analyzing GeneMapper data 1-60
- and 2-2, 3-2
- Applied Biosystems Web Site viii
- Array View page, discussed 1-48
- Assumptions vii
- Audience vii
- Australian standards xxiv
- autoanalysis
 - integration 3-39
- AutoAnalysis Manager
 - scheduling and editing properties 3-31
 - setting up a run for 3-29
 - starting 3-30
- autosampler 1-20

B

- Bar code scanner safety xxiii
- basecaller
 - ABI 2-29
 - KB 2-29
 - options 2-29
- Biological hazard safety xxii

C

- Canadian standards xxiv
- capillary array

- installing and removing 5-12
- maintenance 5-16
- storing off the instrument 5-17
- Capillary View page, discussed 1-49
- Cautions, description xiv
- characters
 - acceptable 2-2, 3-2
 - unacceptable 2-3, 3-3
- checking the plate 1-5
- Chemical safety xviii
- Chemical waste safety xix
- cleaning instrument, routine 5-3
- computer
 - checking hard drive space 5-31
 - configuration requirement A-2
 - start up and log on 1-9
 - starting 1-9
 - technical support for altered configuration A-2
- Computer workstation safety xxiii
- Conventions Used in This Guide viii
- Conventions, safety xiv

D

- Damage, reporting A-4
- Dangers, description xiv
- data
 - spatial calibration 4-2
 - viewing analyzed sequencing data 1-60
 - viewing raw data 1-52
- Data Collection software
 - starting 2-2, 3-2
- database
 - deleting records 5-32
- detection cell, cleaning 5-12
- DyeSet/Primer files
 - list of 2-33

E

- Electrical safety xx
- Electrical symbols, on instruments xv
- Electromagnetic compatibility standards. *See* EMC

standards
EMC standards
 Australian xxiv
 Canadian xxiv
 European xxiv
European standards xxiv

F

fragment analysis
 data analysis 1-60

G

Gases, compressed xxi
GeneMapper
 generic 3-4
 instrument name 3-4
 plate editor 3-11
 review project results 3-34

H

hard drive space, checking 5-31
Hazards
 biological xxii
 chemical xviii
 chemical waste xix
 gases, compressed xxi
 physical xxi
 solvents xxi
 ultraviolet light xxi

I

Importants, description xiv
instrument
 cleaning, routine 5-3
 moving and leveling 5-4
 parts of 1-2
 resetting 5-5
 setup 1-14
 shutdown 5-7
 startup 1-10
 waste handling 5-11

L

Labels, safety
 on instruments xvi
Laser safety
 bar code scanner xxiii
 laser classification xxii
 requirements xxii

Launching Data Collection software 2-2, 3-2
loading standards 4-12

M

maintenance task lists 5-2
matrix standards
 preparing for sequencing 4-11
moving the instrument 5-4
MSDSs
 description xviii
 obtaining xviii

P

parts of the instrument 1-2
password 1-9
pausing a run 1-39
Physical hazard safety xxi
plate
 checking 1-5
plate assembly
 384-well using heat-sealed plate 1-7
 96-well using septa 1-6
 preparing using septa 1-8
 using heat-sealed plate 1-8
 working with 1-5
plate editor
 for GeneMapper 3-11
 for sequencing 2-8
plate records
 discussed 2-4, 3-6
plates
 assembling 1-6
polymer
 changing 5-9
polymer blocks
 air bubbles 5-27
 cleaning 5-22
 installing 1-14
 removing 5-21
Preface vii
Protocol 2-23
 instrument 2-23, 3-25
Protocols 3-25
 Analysis 2-28

R

RA number A-4
raw data, viewing 1-52
reextraction panel

- effects of changes made in 1-53
- removing air bubbles 5-27
- reservoirs
 - filling 1-18
 - positions on the autosampler 1-20
- resetting the instrument 5-5
- Returning damaged items A-4
- Review
 - GeneMapper project results 3-34
- run
 - length of time 1-40
 - starting, stopping, skipping, pausing 1-39
 - stopped before autoextraction is complete 1-53

S

- Safety
 - bar code scanner xxiii
 - before operating the instrument xvii
 - biological hazard xxii
 - chemical xviii
 - chemical waste xix
 - computer workstation xxiii
 - conventions xiv
 - electrical xx
 - gases, compressed xxi
 - instrument xvii
 - laser xxii, xxiii
 - moving and lifting xvii
 - physical hazard xxi
 - solvents xxi
 - ultraviolet light xxi
- Safety alert words xiv
- Safety alerts
 - Cautions xiv
 - Dangers xiv
 - Importants xiv
 - Warnings xiv
- Safety information
 - for system operators xiv
 - sources of xiv
- Safety labels, on instruments xvi
- Safety standards
 - Canadian xxiv
 - European xxiv
 - U.S. xxiv
- Safety symbols, on instruments xv
- sample file destinations 1-53
- samples
 - autoanalyzing 3-33
 - preparing 1-5
 - working with 1-5

- Send Us Your Comments vii
- Send your comments
 - via e-mail vii
- sequencing
 - matrix standards 4-11
 - plate editor 2-8
 - run times 1-40
 - viewing analyzed data 1-60
- Sequencing Analysis Software v5.0 2-2
- service console
 - using 1-11
 - viewer window 1-12
- shut down 5-7
- Solvents, safety xxi
- spatial calibration
 - creating spatial protocols 4-2
 - discussed 4-2
 - evaluating profiles 4-4
 - failed 4-8
 - when required 1-23, 4-2
- spectral calibration 4-9
 - creating spectral protocol 4-13
 - evaluating results 4-23
 - failure 4-23
 - override capillaries 4-27
 - performing 4-13
 - for sequencing 4-11 to 4-21
 - preparing standards for 4-11
 - run times 4-23
 - when required 1-23
- Stacker
 - placing a plate in 1-24
- Standards
 - EMC xxiv
 - safety xxiv
- standards, loading 4-12
- starting
 - Data Collection software 2-2, 3-2
 - instrument 1-10
 - run 1-39
 - spectral calibration run 4-21
- status lights
 - on instrument startup 1-10
- stopping a run 1-39
- Symbols on instruments
 - electrical xv
 - safety xv
- syringes
 - installing and removing 5-20
 - overview 5-18
 - priming and filling 5-19

T

- Technical Support viii
 - for computers with altered configuration A-2
- technical support, obtaining viii
- toolbar 1-39
- tray. *See* plates
- typical run
 - flowchart of 1-3

U

- U.S. standards xxiv
- Ultraviolet light safety xxi
- user control
 - during autoanalysis 3-33
- user name 1-9
- using
 - service console 1-11

W

- Warnings, description xiv
- Warranty
 - damages, claims, returns A-4
 - exceptions A-3
 - for computers with altered configuration A-2
 - period A-2
- waste 5-11
- Waste disposal, guidelines xix
- Waste profiles, described xix
- wizards
 - Change Polymer 5-9
 - Install Capillary Array 5-13

Headquarters

850 Lincoln Centre Drive
Foster City, CA 94404 USA
Phone: +1 650.638.5800
Toll Free: +1 800.345.5224
Fax: +1 650.638.5884

Worldwide Sales Offices

Applied Biosystems vast distribution and service network, composed of highly trained support and applications personnel, reaches into 150 countries on six continents. For sales office locations and technical support, please call our local office or refer to our web site at www.appliedbiosystems.com.

www.appliedbiosystems.com



Applied Biosystems is committed to providing the world's leading technology and information for life scientists.

6/2010
Part Number 4331468 Rev. E