

USER GUIDE

applied
biosystems®
by *life* technologies™

Applied Biosystems® 3130/3130xl Genetic Analyzers

3130 Series Data Collection Software 4

GETTING STARTED

Publication Part Number 4477796 Rev. A

Revision Date May 2012



life
technologies™

For Research Use Only. Not for use in diagnostic procedures.

The information in this guide is subject to change without notice. Applied Biosystems assumes no responsibility for any errors that may appear in this document. This document is believed to be complete and accurate at the time of publication. In no event shall Applied Biosystems be liable for incidental, special, multiple, or consequential damages in connection with or arising from the use of this document.

DISCLAIMER

LIFE TECHNOLOGIES CORPORATION AND/OR ITS AFFILIATE(S) DISCLAIM ALL WARRANTIES WITH RESPECT TO THIS DOCUMENT, EXPRESSED OR IMPLIED, INCLUDING BUT NOT LIMITED TO THOSE OF MERCHANTABILITY, FITNESS FOR A PARTICULAR PURPOSE, OR NON-INFRINGEMENT. TO THE EXTENT ALLOWED BY LAW, IN NO EVENT SHALL LIFE TECHNOLOGIES AND/OR ITS AFFILIATE(S) BE LIABLE, WHETHER IN CONTRACT, TORT, WARRANTY, OR UNDER ANY STATUTE OR ON ANY OTHER BASIS FOR SPECIAL, INCIDENTAL, INDIRECT, PUNITIVE, MULTIPLE OR CONSEQUENTIAL DAMAGES IN CONNECTION WITH OR ARISING FROM THIS DOCUMENT, INCLUDING BUT NOT LIMITED TO THE USE THEREOF.

NOTICE TO PURCHASER: LIMITED USE LABEL LICENSE NO: 358: Research Use Only

The purchase of this product conveys to the purchaser the limited, non-transferable right to use the product only to perform internal research for the sole benefit of the purchaser. No right to resell this product or any of its components is conveyed expressly, by implication, or by estoppel. This product is for internal research purposes only and is not for use in commercial applications of any kind, including, without limitation, quality control and commercial services such as reporting the results of purchaser's activities for a fee or other form of consideration. For information on obtaining additional rights, please contact outlicensing@lifetech.com or Out Licensing, Life Technologies, 5791 Van Allen Way, Carlsbad, California 92008.

NOTICE TO PURCHASER:

This instrument is Authorized for use in DNA sequencing and fragment analysis. This authorization is included in the purchase price of this instrument and corresponds to the up-front fee component of a license under process claims of U.S. patents and under all process claims for DNA sequence and fragment analysis of U.S. patents now or hereafter owned or licensable by Applied Biosystems for which an Authorization is required, and under corresponding process claims in foreign counterparts of the foregoing for which an Authorization is required. The running royalty component of licenses may be purchased from Applied Biosystems or obtained by using Authorized reagents purchased from Authorized suppliers in accordance with the label rights accompanying such reagents. Purchase of this instrument does not itself convey to the purchaser a complete license or right to perform the above processes. This instrument is also licensed under U.S. patents and apparatus and system claims in foreign counterparts thereof. No rights are granted expressly, by implication or by estoppel under composition claims or under other process or system claims owned or licensable by Applied Biosystems. For more information regarding licenses, please contact the Director of Licensing at Applied Biosystems, 850 Lincoln Centre Drive, Foster City, California 94404, USA.

NOTICE TO PURCHASER

The purchase price of this Applied Biosystems 3130/3130xl Genetic Analyzer includes a grant of a limited, non-transferable license under U.S. patent claims and method claims of its foreign counterparts, and element claims of its foreign counterparts, to use this particular instrument for electrophoresis methods employing fluorescence as a means of detection. No other licenses or rights are hereby conveyed either expressly, by implication, or estoppel including, but not limited to, any claims to a composition.

HITACHI The Applied Biosystems 3130 and 3130xl Genetic Analyzers includes patented technology licensed from Hitachi, Ltd. as part of a strategic partnership between Applied Biosystems and Hitachi, Ltd., as well as patented technology of Applied Biosystems.

TRADEMARKS

The trademarks mentioned herein are the property of Life Technologies Corporation or their respective owners.

Applied Biosystems, AmpFISTR, BigDye, Cofiler, GeneMapper, Identifier, POP-4, Profiler, Profiler Plus ID, SeqScape, SGM Plus, SNaPshot, StockMarks, Variant Reporter, and Yfiler are registered trademarks and AB (Design), Applera, Hi-Di, KB, POP, POP-6, POP-7, and SEfiler are trademarks of Applied Biosystems or its subsidiaries in the U.S. and/or certain other countries.

Microsoft, Windows, and Windows XP are registered trademarks of the Microsoft Corporation in the United States and other countries.

Oracle is a registered trademark of the Oracle Corporation.

All other trademarks are the sole property of their respective owners.

© 2012 Life Technologies Corporation. All rights reserved.

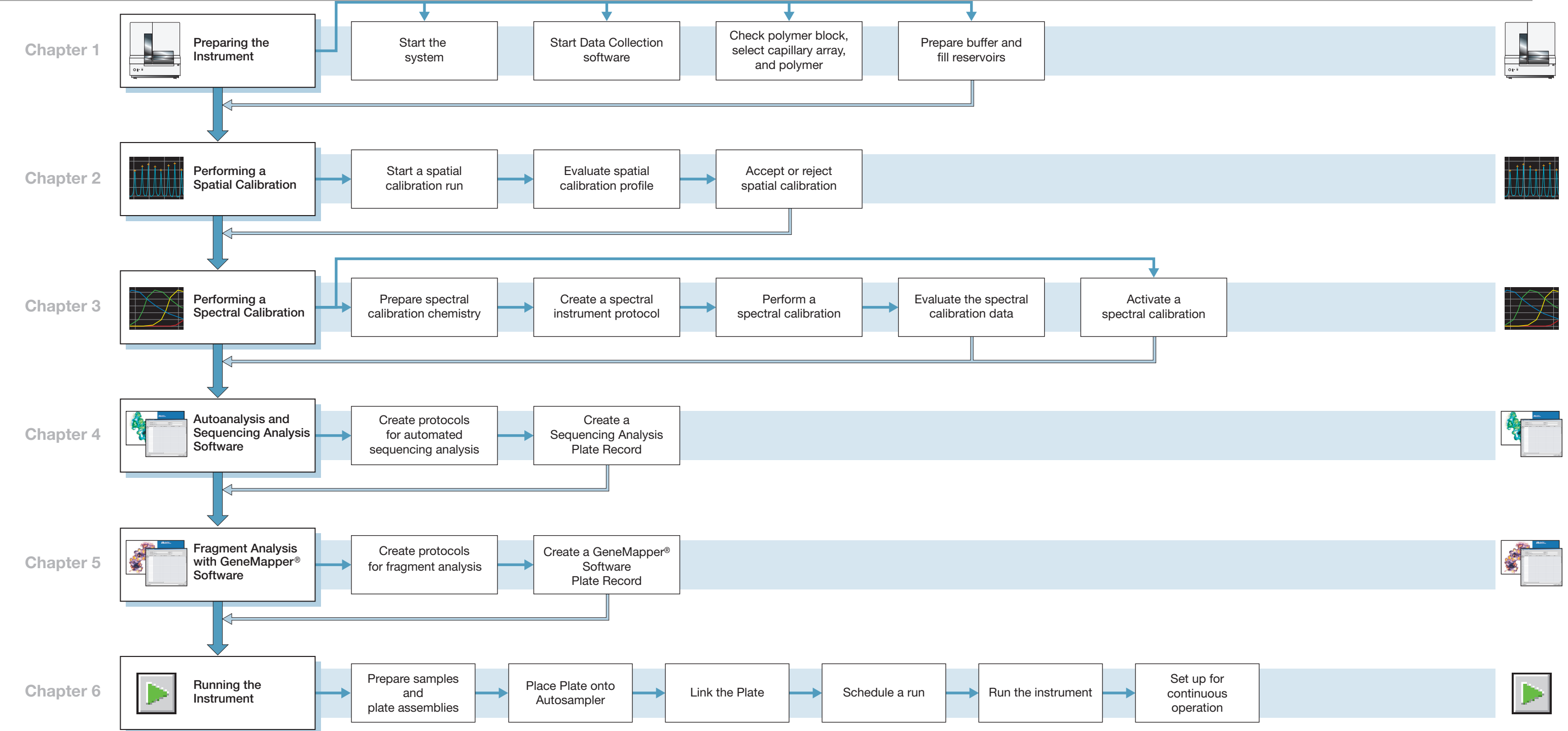

Contents

Chapter 1	Preparing the Instrument	9
	Instrument Description	10
	Application Summary Tables	11
	Barcode Readers	15
	Starting the 3130/3130x/ Genetic Analyzer System	16
	Data Collection Software	18
	Preparing the Instrument	20
	Preparing Buffer and Filling Reservoirs	26
Chapter 2	Performing a Spatial Calibration	31
	Spatial Calibration	32
	Creating a Spatial Calibration File	32
	Evaluating a Spatial Calibration File	34
	Examples of Spatial Profiles	36
Chapter 3	Performing a Spectral Calibration	37
	Spectral Calibration	38
	Preparing the Spectral Calibration Chemistry	41
	Loading Samples	42
	Creating a Spectral Instrument Protocol	45
	Performing a Spectral Calibration	47
	Evaluating the Spectral Calibration Data	53
	Activating a Spectral Calibration	57
	Examples of Passing Sequencing Spectral Calibrations	59
	Examples of Passing Fragment Analysis Spectral Calibrations	61
Chapter 4	Autoanalysis and Sequencing Analysis Software	63
	Sequencing Analysis Software	64
	About Plate Records and Sequencing Analysis	65
	Creating Protocols for Automated Sequencing Analysis	69
	Analysis Protocol for Sequencing Analysis	72
	Results Group for Sequencing Analysis	81
	Filling Out a Sequencing Analysis Plate Record	88

Chapter 5	Fragment Analysis with GeneMapper® Software	91
	GeneMapper® Software	92
	About GeneMapper Software Plate Records	94
	Creating Protocols for Fragment Analysis	98
	Creating a GeneMapper® Software Plate Record	109
Chapter 6	Running the Instrument	113
	Preparing Samples and Plate Assemblies	114
	Linking and Unlinking a Plate	114
	Running the Instrument	116
	Controlling the Run	118
	Set Up for Continuous Operation	119
	Working with Data in The Run History View	130
	Viewing Data from a Completed Run in the Data Collection Software	131
	Viewing Autoextraction Results	132
	Viewing Analyzed Data	140
Appendix A	Plate Mapping	141
	Injection Scheduling	141
	Capillary Array Map	141
	96-Well Plate Mapping	142
	384-Well Plate Mapping	143
Appendix B	KB™ Basecaller Software v1.4.1	145
	Executive Summary	145
	Benefits of using the KB™ Basecaller	146
	Future support of ABI and KB™ Basecallers	149
	Features in KB™ Basecaller Software v1.4.1	149
	Comparison of the ABI and KB™ Basecallers	150
	Differences between the ABI and KB™ Basecallers	151
	FAQs: Processing data with Phred software and .phd.1 Files	154
	FAQs: Quality values	155
	Miscellaneous FAQs	157
	Conference posters and reference	158
Appendix C	Managing Software License for 3130 Series Data Collection Software 4	159
	Manage software licenses	159
	Obtain and activate a software license	159
	Renew a software license	161

Safety	165
Symbols on instruments	165
Safety alerts on this instrument	166
Instrument safety	167
Safety and electromagnetic compatibility (EMC) standards	169
Chemical safety	171
Biological hazard safety	173
Safety Labels on Instruments	173
Workstation Safety	174
Documentation and Support	177
Related documentation	177
Obtaining SDSs	177
Obtaining Support	177
Computer Configuration	178
Limited Product Warranty	178
Index	179

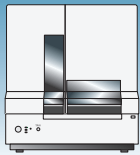

Preparing the Instrument

IMPORTANT! Before using this product, read and understand the information in the “Safety” appendix in this document.

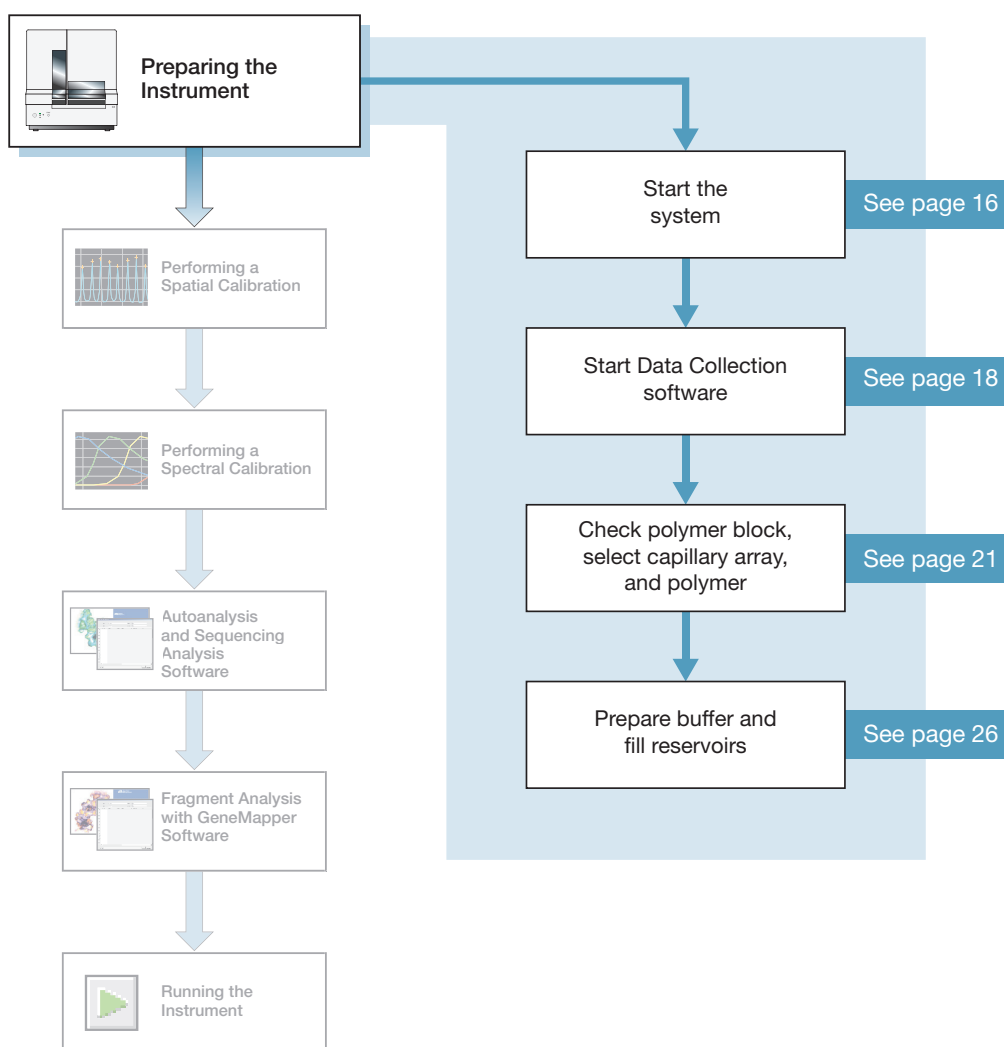

1

Notes _____



Instrument Description

Instrument Layout A typical laboratory layout is shown below.

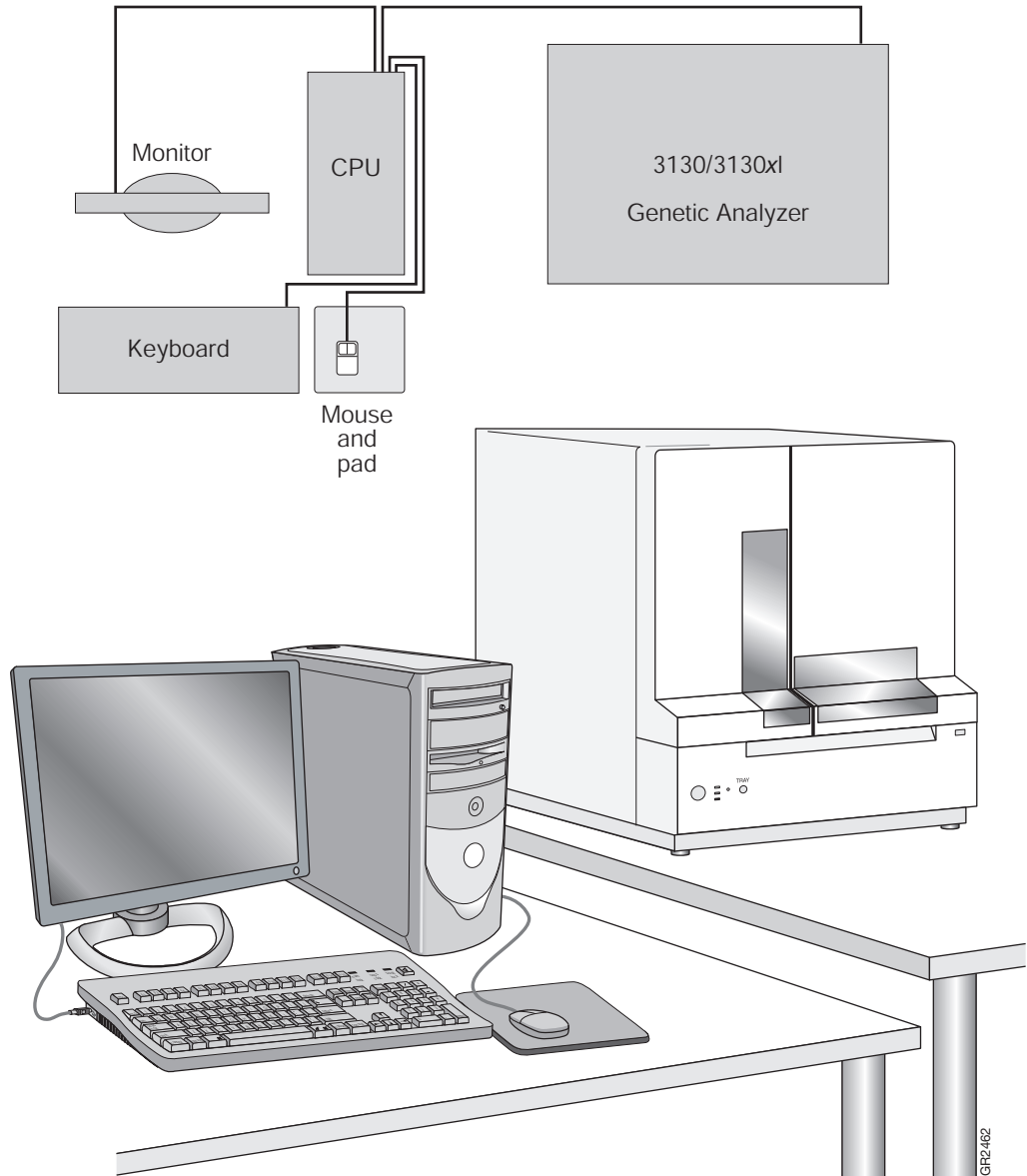

GR2462

Notes _____



Application Summary Tables

Sequencing Resolution Performance and Specifications

Decide what combination of capillary array and polymer from the table below matches your resolution and performance specifications.

Type of Run	Capillary Length (cm)	Polymer Type	Module ^a	Run Time (min)	24 hr Throughput (number of samples)		KB Basecaller QV ₂₀ LOR ^{b c}
					3130 Genetic Analyzer	3130x/ Genetic Analyzer	
Ultra rapid	36	POP-4 [®]	UltraSeq36_POP4	40	144	576	400
		POP-7 [™]	UltraSeq36_POP7	35	164	656	500
Rapid	36	POP-6 [™]	RapidSeq36_POP6	60	96	384	500
		POP-7 [™]	RapidSeq36_POP7		96	384	600
Fast	50	POP-7 [™]	FastSeq50_POP7	60	96	384	700
Standard	50	POP-4 [®]	StdSeq50_POP4	100	56	224	600
		POP-6 [™]	StdSeq50_POP6	150	36	144	600
		POP-7 [™]	StdSeq50_POP7	120	48	192	850
Long read	80	POP-4 [®]	LongSeq80_POP4	210	24	96	700
		POP-7 [™]	LongSeq80_POP7	170	32	128	950

a When using the BigDye XTerminator Purification Kit, choose the BDx version of the Run Modules; for example, BDx_UltraSeq36_POP7.

b Length of Read (LOR) is the usable range of high-quality or high-accuracy bases determined by Quality Values (QV) generated by KB Basecaller v1.2. The LOR is determined by using a sliding window of 20 bases, which has an average QV > 20.

c 98.5% basecalling accuracy, less than 2% Ns.

Notes _____



Fragment Analysis Run Module Specifications

Decide what combination of capillary array and polymer from the table below matches your resolution and performance specifications. See “[Fragment Analysis Application/Kit and Run Modules](#)” on page 13 for information on capillary, polymer, and run module.

Run Modules	Capillary Length (cm)	Polymer Type	Run Time (min)	24 hr Throughput (GT ^b)	
				3130 Analyzer	3130x/ Analyzer
High Throughput, Small Size Fragment Analysis					
FragmentAnalysis22_POP4	22	POP-4 [®]	20	5,760	23,040
SNP22_POP4	22		20	5,760	23,040
Standard Fragment Analysis					
FragmentAnalysis36_POP4	36	POP-4 [®]	45	2,560	10,240
HIDFragmentAnalysis36_POP4			45	2,560	10,240
SNP36_POP4			30	3,840	15,360
FragmentAnalysis36_POP7	50	POP-7 [™]	35	3,290	13,170
FragmentAnalysis50_POP4		POP-4 [®]	65	1,760	7,040
FragmentAnalysis50_POP6		POP-6 [™]	90	1,200	4,800
FragmentAnalysis50_POP7		POP-7 [™]	50	2,300	9,220
Large Size Fragment Analysis					
GS1200_36_POP7	36	POP-7 [™]	125	880	3,520
GS1200_50_POP7	50	POP-7 [™]	135	800	3,200
Fragment Analysis using Non-Denaturing Polymer					
ConformationAnalysis36_CAP	36	CAP	a	a	a

a Run time and 24 hour Throughput depend on customized polymer formulation and run module.

b 20 GT (Genotypes)/capillary/injection.

Notes _____



Fragment Analysis Application/Kit and Run Modules

The table below lists the Applied Biosystems kit types, with the available run module(s) and dye sets.

Application/Kit	Module										
	SNP22_POP4	SNP36_POP4	HTSNP36_POP7	FragmentAnalysis22_POP4	FragmentAnalysis36_POP4	FragmentAnalysis36_POP7	FragmentAnalysis50_POP4	FragmentAnalysis50_POP6	FragmentAnalysis50_POP7	HIDFragmentAnalysis36_POP4	ConformationAnalysis36_CAP
SNaPshot® Multiplex System	E5	E5									
Custom oligos				D, F, G5	D, F, G5	D, F, G5	D, F, G5	D, F, G5	D, F, G5		
Single Strand Conformation Polymorphism (SSCP) Analysis using non-denaturing Conformational Analysis Polymer (CAP)											G5 ^a
4-Dye Stockmarks® Kits (bovine and canine)					F						
5-Dye Stockmarks® Kit (equine)					G5						
AFLP® Kits					F						
4-Dye AmpF ℓ STR® Kits										F	
5-Dye AmpF ℓ STR® Kits										G5	

^a Adjust Dye Set depending on dyes used. Use filter set G5 if using the GeneScan 600 LIZ Size Standard, along with the Matrix Standard Set DS-33. Use filter set D if using the Gene Scan 500 ROX Size Standard.

AmpF ℓ STR® Kit Table

Kits	HIDFragmentAnalysis36_POP4
AmpF ℓ STR® COfiler® Kit	F
AmpF ℓ STR® Profiler Plus® Kit	
AmpF ℓ STR® Profiler Plus® ID Kit	
AmpF ℓ STR® Profiler® Kit	
AmpF ℓ STR® SGM Plus® Kit	
Other 4-Dye AmpF ℓ STR® Kits	

Notes



Chapter 1 Preparing the Instrument

Application Summary Tables

Kits	HIDFragmentAnalysis36_POP4
AmpF λ STR [®] SEfiler Plus [™] Kit	G5
AmpF λ STR [®] Identifiler [®] Kit	
AmpF λ STR [®] Yfiler [®] Kit	
AmpF λ STR [®] Identifiler [®] Plus Kit	
AmpF λ STR [®] Identifiler [®] Direct Kit	
AmpF λ STR [®] Sinofiler [™] Kit	
AmpF λ STR [®] MiniFiler [™] Kit	
AmpF λ STR [®] NGM [™] Kit	
AmpF λ STR [®] NGM Select [™] Kit	
Other 5-Dye AmpF λ STR [®] Kits	

Notes _____



Barcode Readers

 **DANGER ELECTRICAL HAZARD.** Power off the instrument and the computer before connecting an external barcode reader to the instrument.

External Barcode Readers

KEYENCE BL-80VE

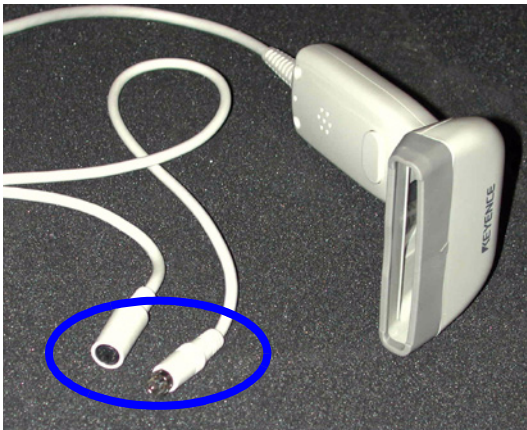

An external barcode reader can be used with the 3130/3130x/ instrument. With the KEYENCE BL-80VE (see photo above), which connects to the instrument computer keyboard, you can scan barcodes into any text box in the Data Collection software. The KEYENCE BL-80VE barcode reader uses an LED as a light source.

Notes _____



Starting the 3130/3130xl Genetic Analyzer System

Starting the Computer Workstation

IMPORTANT! You must start the computer workstation before starting the instrument.

1. Power on the monitor.

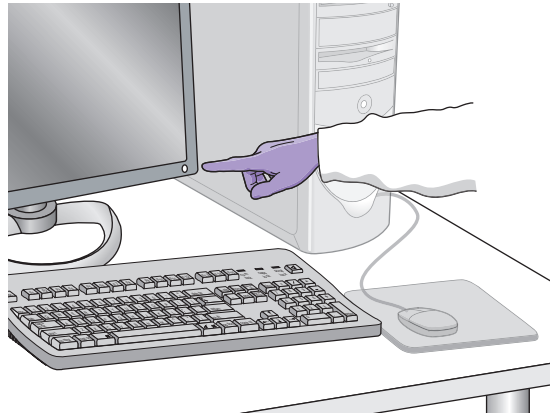

2. Power on the computer.

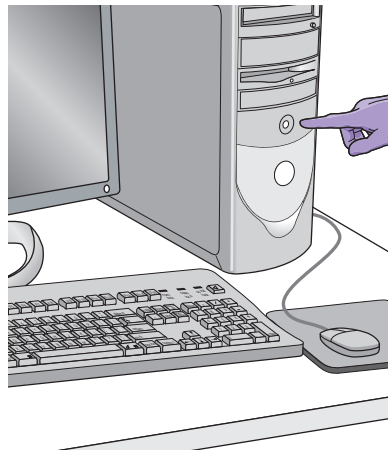

3. In the Log On to Windows dialog box:

- a. Enter the user name.
- b. If applicable, enter a password.

Note: If the computer is connected to a network, you do not need to log on to the network before starting the instrument.

- c. Click .



Notes _____



Starting the 3130/3130xl Genetic Analyzer

1. Ensure that the:
 - Oven door is closed and locked
 - Instrument doors are closed

Note: If the doors are open during power on, the yellow light will continue to flash until you close the doors.

2. Ensure that the computer is powered on.

Note: The computer must be on and running to allow the instrument to copy the firmware from the computer.

3. Power on the instrument by pressing the on/off button on the front of the instrument.

Note: While the instrument is booting up and performing self-checks, the yellow status light blinks.

4. Ensure the green status light is on and not flashing before proceeding.

Note: If the green status light does not come on, start the Data Collection software and view the log. The pathway to the log is:
E:\AppliedBiosystems\UDC\DataCollection\
Log*Instrument Name*

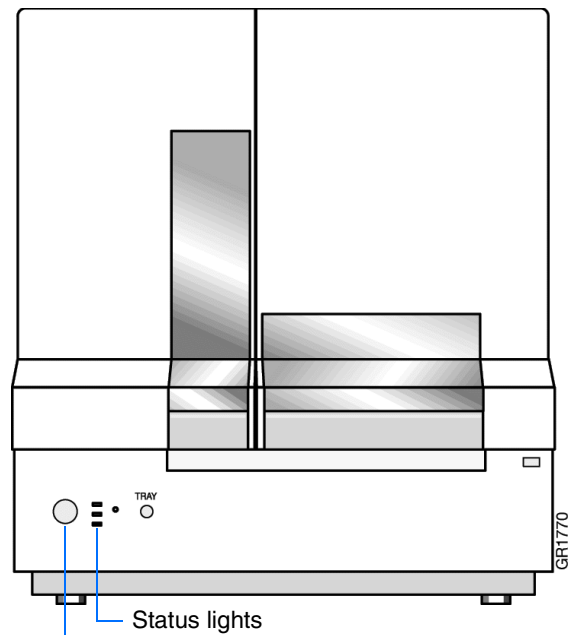

Press the on/off button to start the instrument

Notes _____



Data Collection Software

IMPORTANT! Do not rename the computer. The instrument computer was assigned a unique name before the 3130 Series Data Collection Software 4 was installed. Do not rename the computer once the Data Collection software has been installed. Doing so may cause the Data Collection software to malfunction.

Starting the 3130 Series Data Collection Software 4

1. Select **Start > All Programs > Applied Biosystems > Data Collection > 3130 Series 4** to display the Service Console. By default, all applications are off, indicated by the red circles. They launch automatically with the 3130/3130x/ Data Collection software.

Note: 3130 Series Data Collection Software 4 runs on Windows 7 SP1 professional 32-bit operating system.

Note: The 3130 Series Data Collection Software 4 requires a license to run. Read details in [Appendix C, “Managing Software License for 3130 Series Data Collection Software 4.”](#)

As each application activates, the red circles (off) change to yellow triangles (activating), and then to green squares (on) when they are fully functional.

When the Data Service component displays the yellow triangle, do not press Start All or Stop All; if either is selected, you will need to re-boot the computer.

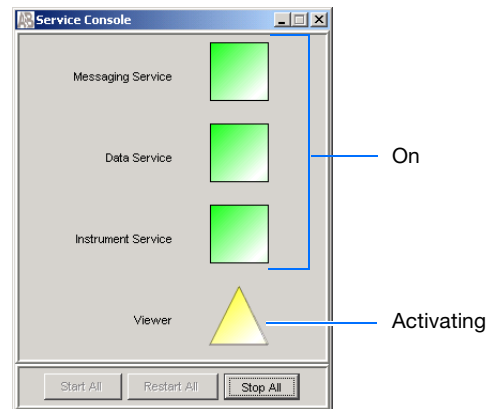

Notes



When all the applications are running (displaying all green squares—this could take several minutes), the Foundation Data Collection window displays.

Note: Ensure that all Data Collection Services are running before you launch the AB Navigator tool for security, audit trail, and electronic signature features (as described in the *AB Navigator Software Administrator Guide*, Part no. 4477853). All services are running when the Service Console contains four green squares.

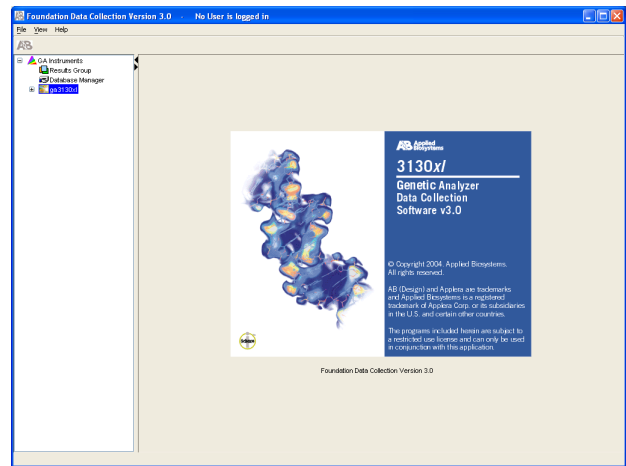
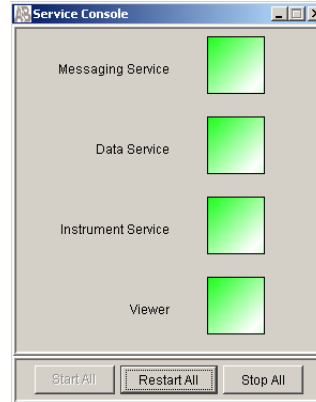

2. Click + to expand subfolders in the left tree pane. All application folders are now visible. Select items from this tree pane to open manager, viewer, and other program windows.

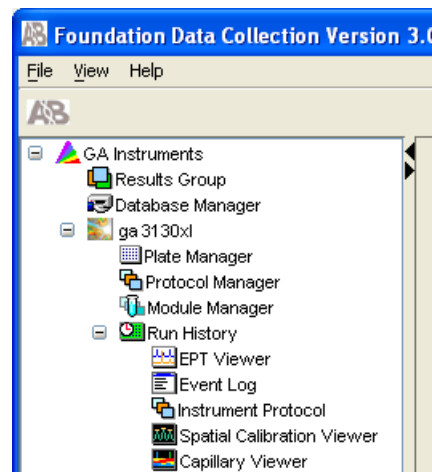

Notes _____



Preparing the Instrument

Instrument Doors and Interior

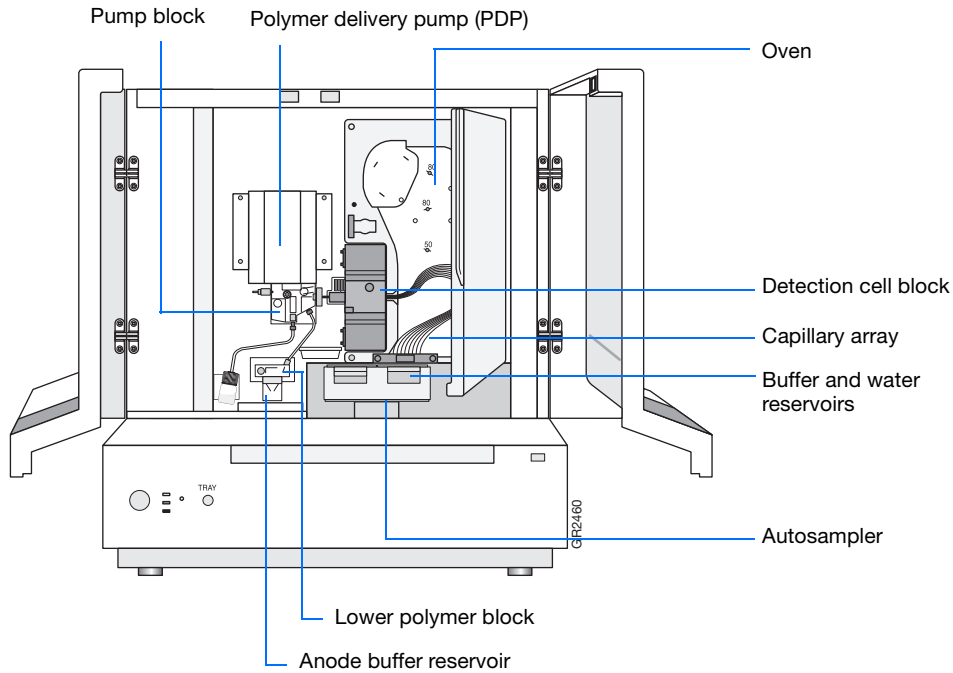

Part	Function
Anode buffer reservoir	Contains 16 mL of 1X running buffer.
Buffer and water reservoirs (four)	Each contain 16 mL of 1X running buffer or water.
Autosampler	Holds the sample plates and reservoirs and moves to align the samples, water, or buffer with the capillaries.
Capillary array	Enables the separation of the fluorescent-labeled DNA fragments by electrophoresis. It is a replaceable unit composed of 4 or 16 silica capillaries.
Detection cell block and heater	Holds the capillaries in place for laser detection.
Lower polymer block	Contains the buffer valve, anode electrode, and anode buffer reservoir.
Oven	Maintains uniform capillary array temperature.
Polymer delivery pump (PDP)	Pumps polymer into the array and performs maintenance procedures.
Pump block	Includes the displacement pump chamber, piston water seal, array attachment point (array port), and connection to the lower polymer block through the interconnect tube.

Notes _____



Inspecting the Instrument

1. Open the instrument doors.
2. Perform the daily maintenance tasks according to Chapter 1 in the *Applied Biosystems 3130/3130xl Genetic Analyzers Maintenance, Troubleshooting and Reference Guide* (Part no. 4477854).
3. Install clean drip trays.

Polymer Delivery Pump

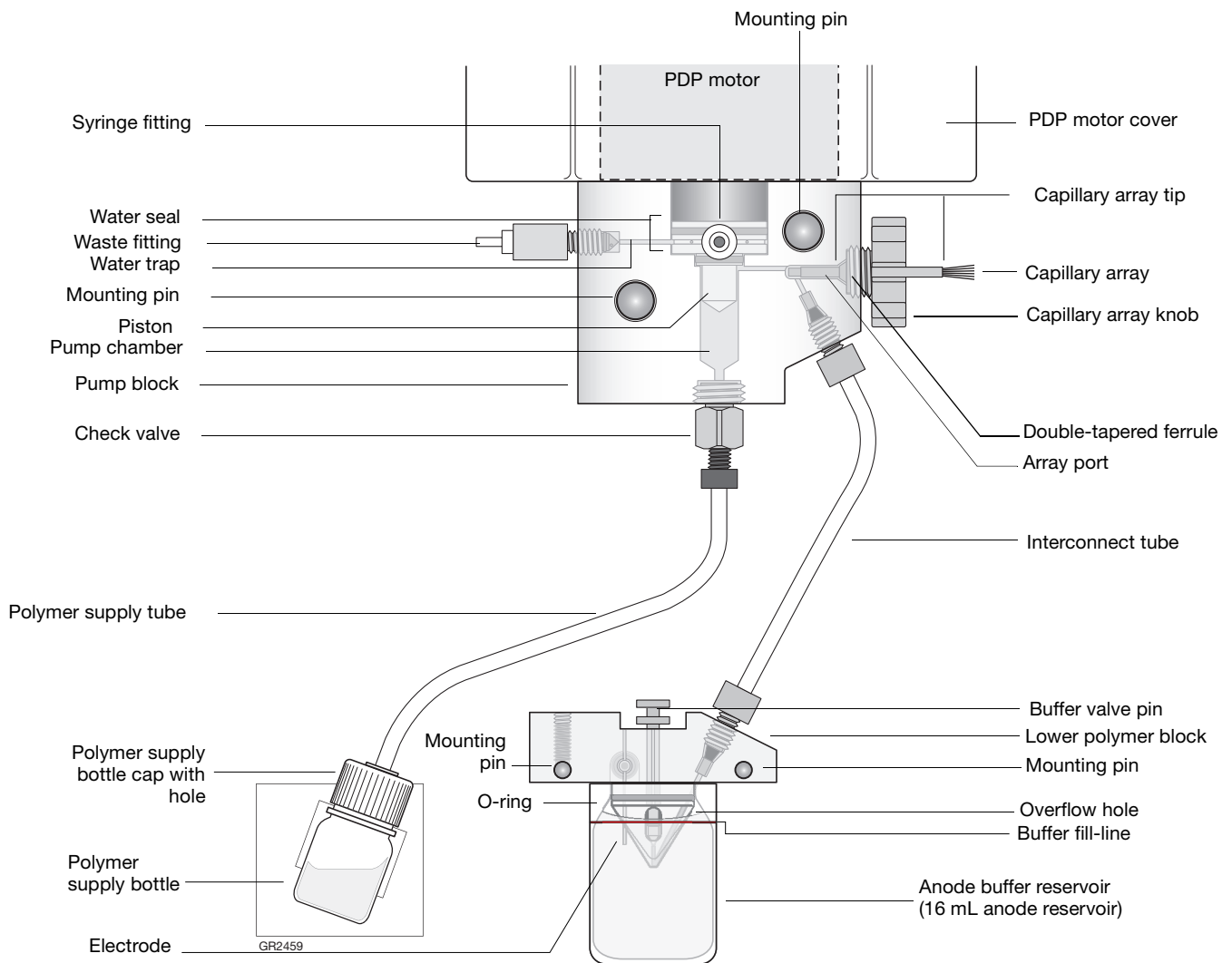

Notes



Inspecting the Instrument

1. Open the instrument doors.
2. Perform the daily maintenance tasks according to the *Applied Biosystems 3130/3130xl Genetic Analyzers Maintenance, Troubleshooting and Reference Guide* (Part no. 4477854) for more detail on maintenance.
3. Install clean drip trays.

Installing or Replacing the Capillary Array

IMPORTANT! The capillary array length defined in the wizard must match the array length you are using for correct autoanalysis results.

IMPORTANT! Use of CAP Polymer requires a dedicated array. CAP polymer is not compatible with any other POP polymer. Even trace amounts of CAP polymer with other polymers will irreparably damage the array and pump and void any service contract or warranty for the instrument. It is important to use a capillary array, polymer block, and syringe for CAP polymer use exclusively. Also, buffer and water reservoirs should be cleaned every time a different polymer is used.

IMPORTANT! Wear gloves while handling polymer, the capillary array, septa, or buffer reservoirs.



 **CAUTION CHEMICAL HAZARD. POP polymer** may cause eye, skin, and respiratory tract irritation. Please read the SDS, and follow the handling instructions. Wear appropriate protective eyewear, clothing, and gloves. Use for research and development purposes only.

Notes _____



1. Install a capillary array by clicking *<instrument name>*, selecting **Install Array Wizard** and following the prompts.

IMPORTANT! To install or replace an array that is a different length than the one you were using, reset the active spectral calibration (see [page 57](#)) or create a new spectral calibration for your dye set and array length combination (see [page 47](#)).

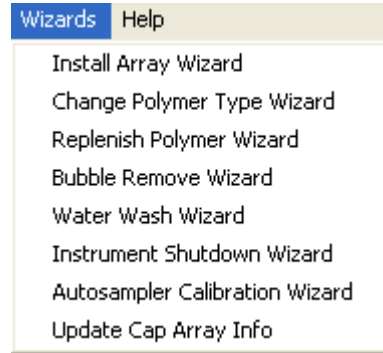

2. Optional: Select **Update Cap Array Info** wizard to correct any errors or update capillary array and serial number information.

When to Replenish or Change Polymer

IMPORTANT! Always replace polymer that has been on the instrument longer than one week.

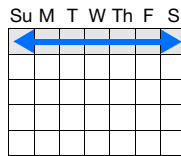

If polymer on the instrument...	Then ...
has been on less than one week and is in sufficient quantity to complete your runs ^a	Remove all bubbles, and then proceed with instrument preparation.
has been on less than one week, and insufficient in quantity to complete your runs	Add fresh polymer to the polymer supply by following the Replenish Polymer Wizard.
has been on longer than one week	
is the wrong type (a change between POP-4, POP-6, POP-7, and/or CAP Polymers is required)	Replace the installed polymer type with a different type by following the Change Polymer Type Wizard.

^a A 3130x/ genetic analyzer run uses 50 to 80 μ L of polymer and a 3130 genetic analyzer run uses ~25 to 40 μ L of polymer.

Before Using the Polymer

1. Remove the polymer from 4°C storage.
2. Loosen the cap and bring the polymer to room temperature.
3. To dissolve deposits, tighten the cap and gently swirl the polymer.

Notes



Replenishing the Polymer

IMPORTANT! Wear gloves while handling polymer, the capillary array, septa, or buffer reservoirs.



CAUTION CHEMICAL HAZARD.

POP polymer may cause eye, skin, and respiratory tract irritation. Please read the SDS, and follow the handling instructions. Wear appropriate protective eyewear, clothing, and gloves. Use for research and development purposes only.

1. Click < **Instrument Name** > in the tree pane.
2. Select **Wizards > Replenish Polymer Wizard** to replenish polymer.

IMPORTANT! The polymer type defined in the wizard must match the polymer type that you are using.

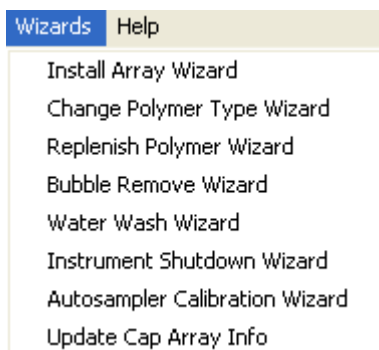

Changing Polymer Type

IMPORTANT! Wear gloves while handling polymer, the capillary array, septa, or buffer reservoirs.



IMPORTANT! Use of CAP Polymer requires a dedicated array. CAP polymer is not compatible with any other POP polymer. Even trace amounts of CAP polymer with other polymers will irreparably damage the array and pump and void any service contract or warranty for the instrument. It is important to use a capillary array, polymer block, and syringe for CAP polymer use exclusively. Also, buffer and water reservoirs should be cleaned every time a different polymer is used.

Notes



CAUTION CHEMICAL HAZARD.
POP polymer may cause eye, skin, and respiratory tract irritation. Please read the SDS, and follow the handling instructions. Wear appropriate protective eyewear, clothing, and gloves. Use for research and development purposes only.

1. Click < **Instrument Name**> in the tree pane.
2. Select **Wizards > Change Polymer Type Wizard** to change to a different polymer.
After you use the Change Polymer Type Wizard, either perform a new spectral calibration or activate a previously created spectral calibration in the Spectral Viewer.

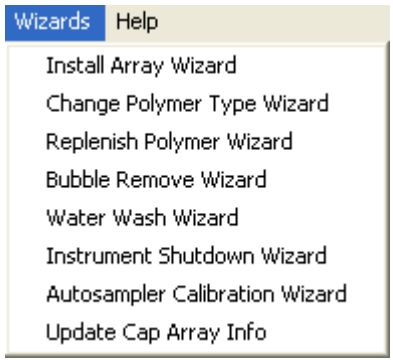

Notes _____



Preparing Buffer and Filling Reservoirs

Required Materials

CAUTION CHEMICAL HAZARD. 10X Genetic Analyzer Buffer with EDTA may cause eye, skin, and respiratory tract irritation. Read the SDS, and follow the handling instructions. Wear appropriate protective eyewear, clothing, and gloves.

Required materials to prepare 1X running buffer:

- 10X Genetic Analyzer Buffer (Part no. 402824)
- Purified (distilled or deionized) water
- 50 mL graduated cylinder

Preparing Buffer for a Single Run

1. Add 5 mL of 10X Genetic Analyzer Buffer into a graduated cylinder.
2. Add purified water to bring the total volume up to 50 mL.
3. Mix well.

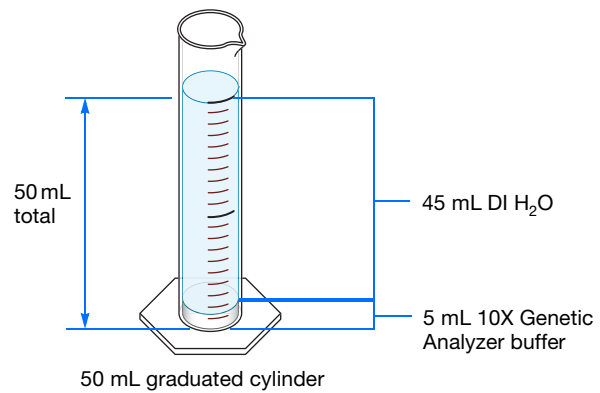

Storing Buffer

Store 1X running buffer at:

- 2 to 8°C for up to 1 month
- Room temperature for 1 week

Buffer Storage Conditions	
Option A	Option B
<p>2 to 8°C</p>	<p>20 to 25°C</p>
<p>1 month</p>	<p>7 days</p>

Notes _____



Replacing Buffer and Water

Replace the 1X running buffer in the anode and cathode buffer reservoirs daily, or before each batch of runs.

IMPORTANT! Failing to replace buffer may lead to loss of resolution and data quality.

IMPORTANT! To clean and refill the reservoirs, the autosampler is brought to the forward position, thereby leaving the capillary tips exposed to the air. Do not leave the autosampler in this position for an extended time because the capillaries can dry out and the array may be damaged.

Buffer and water reservoirs should be cleaned every time a different polymer is used.

Filling the Water and Cathode Buffer Reservoirs

IMPORTANT! Wear gloves while performing the following procedure, and any other time you handle the capillary array, septa, or buffer reservoirs.



 **CAUTION** **CHEMICAL HAZARD.**

1X Genetic Analyzer Buffer with EDTA may cause eye, skin, and respiratory tract irritation. Read the SDS, and follow the handling instructions. Wear appropriate protective eyewear, clothing, and gloves.

1. Verify the oven and instrument doors are closed.
2. Press the Tray button on the outside of the instrument to bring the autosampler to the forward position
3. Wait until the autosampler stops at the forward position, then open the instrument door.



Notes



Chapter 1 Preparing the Instrument

Preparing Buffer and Filling Reservoirs

- Remove the cathode buffer and water reservoirs from the instrument.
- Dispose of remaining fluids and rinse out the reservoirs with deionized water.

Note: Follow your company's waste disposal practices for appropriate disposal procedures.

- Rinse the cathode reservoir with 1X running buffer, and then fill to the line with 1X running buffer (about 16 mL).
- Fill the two water reservoirs to the line with quality deionized water (about 16 mL).



CAUTION Be sure that the septa fit securely and flush on the tops of the reservoirs to prevent damaging the capillary tips.

- Place a clean reservoir septa on each reservoir, and dry the outside of the reservoirs using a lint-free tissue wipe.
- Place the reservoirs into position on the autosampler as shown.

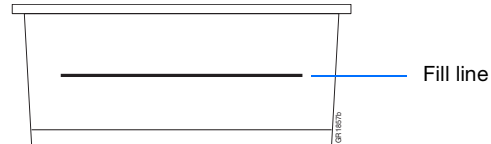
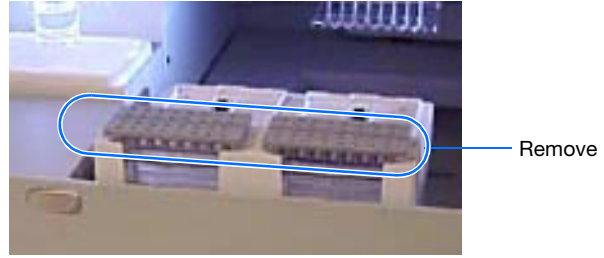

- Close the instrument doors.

Note: Closing the doors returns the autosampler to the last known position, placing the tips of the capillaries in water or buffer.

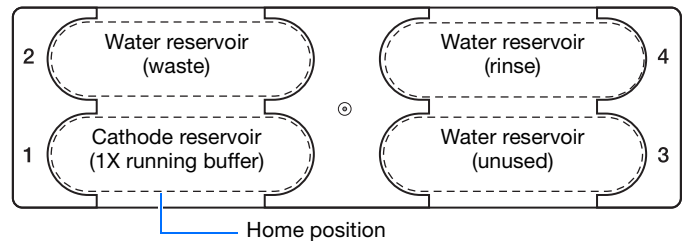

Notes _____



Filling the Anode Buffer Reservoir

Change the anode buffer:

- Every 24 hours
- Before each run or batch of runs
- Every time you replenish the polymer or change polymer type

CAUTION **CHEMICAL HAZARD.**

1X Genetic Analyzer Buffer with EDTA may cause eye, skin, and respiratory tract irritation. Read the SDS, and follow the handling instructions. Wear appropriate protective eyewear, clothing, and gloves.

1. Remove the anode buffer reservoir by firmly pulling down and twisting slowly.
2. Discard the used buffer appropriately.
3. Clean and rinse the reservoir with deionized water, and then rinse with buffer.
4. Fill the anode buffer reservoir to the fill line with fresh 1X running buffer (about 16 mL).

Note: The meniscus should line up with the fill line.

5. Put the anode buffer reservoir on the instrument.
6. If the reservoir fills with fluid, repeat this procedure to discard and replace the running buffer.

Note: The reservoir could fill during bubble removal.

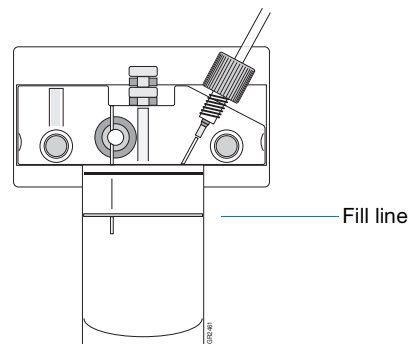
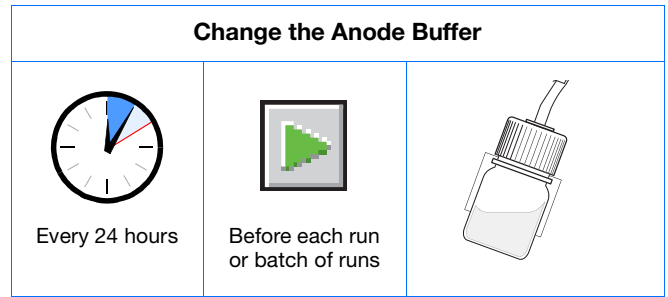

Notes _____



Chapter 1 Preparing the Instrument

Preparing Buffer and Filling Reservoirs

Notes _____

Performing a Spatial Calibration

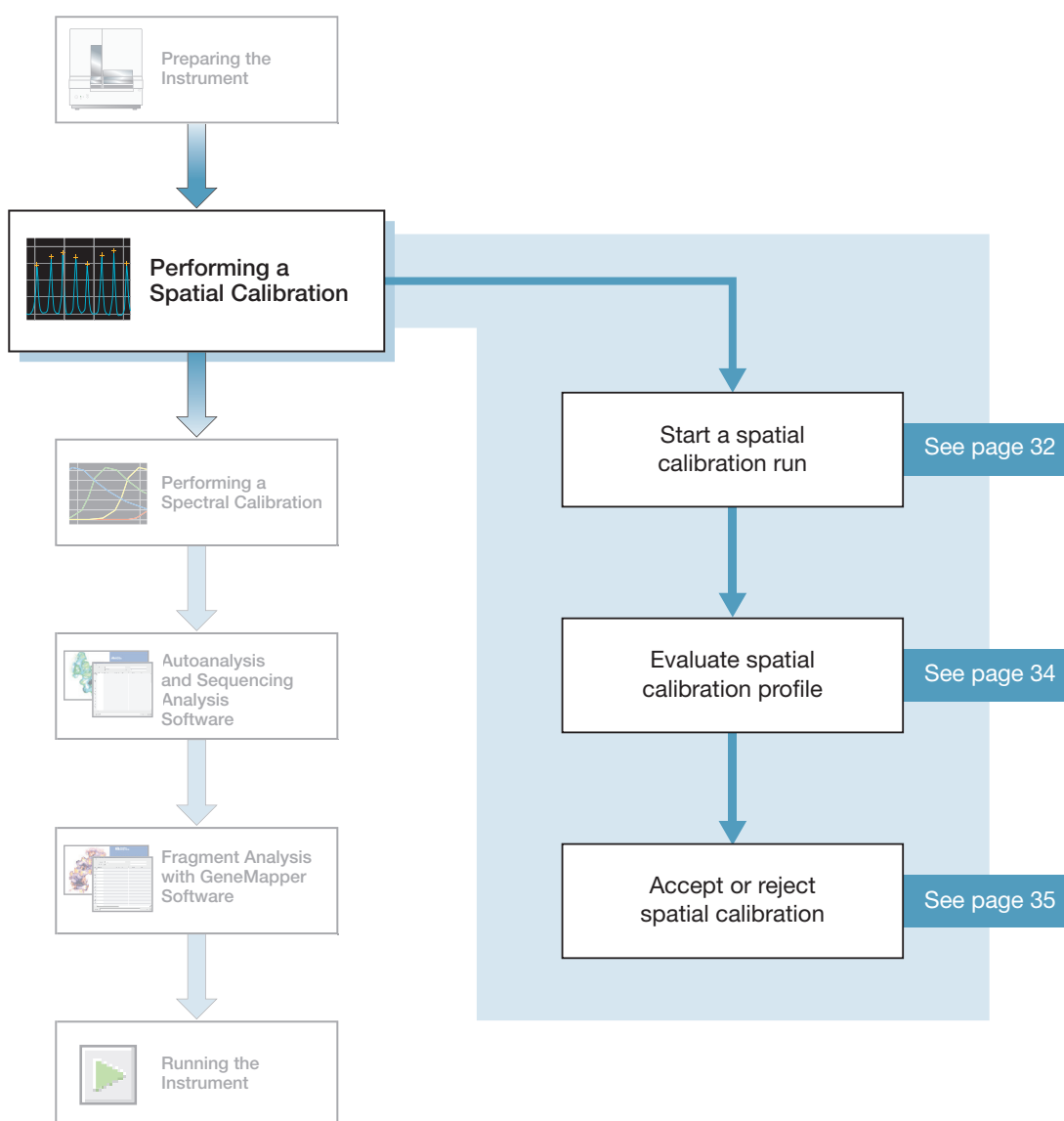
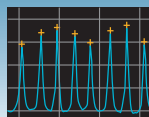

2

Notes

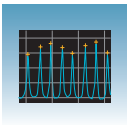

Spatial Calibration

The 3130 Series Data Collection Software 4 uses images collected during the spatial calibration to establish a relationship between the signal emitted by each capillary and the position where that signal falls on and is detected by the CCD camera.





When to Perform the Calibration

You are required to perform a spatial calibration when you:

- Install or replace a capillary array
- Temporarily remove the capillary array from the detection block
- Move the instrument
- Every time a new bottle of CAP polymer is installed on the instrument

IMPORTANT! CAP polymer is not compatible with any other POP polymer. Even trace amounts of CAP polymer with other polymers will irreparably damage the array and pump and void any service contract or warranty for the instrument. It is important to dedicate a capillary array, polymer block, and syringe for CAP polymer use exclusively. Also, buffer and water reservoirs should be cleaned every time a different polymer is used.

Creating a Spatial Calibration File

1. In the tree pane of the Data Collection software, click  **GA Instruments** >  **ga3130** or **ga3130xl** >  *instrument name* >  **Spatial Run Scheduler**.

Notes _____

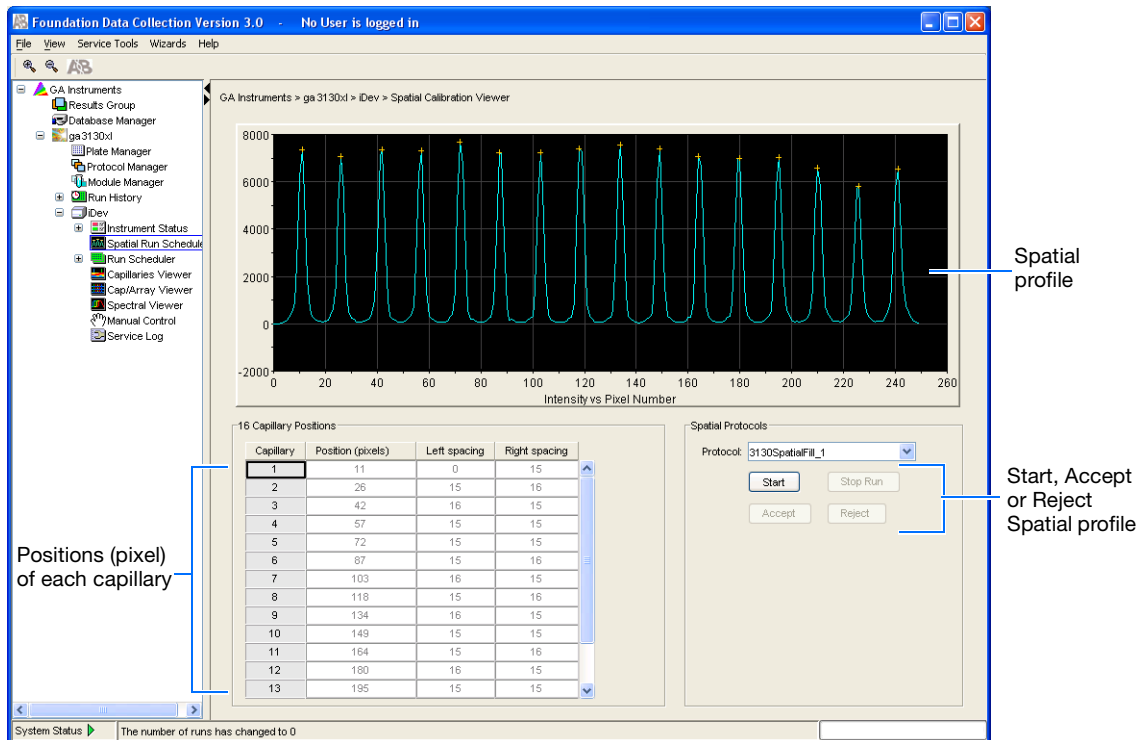
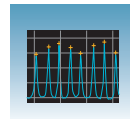

2. In the Spatial Protocols section, select one of the following:

- If the capillaries contain fresh polymer, select **Protocol > 3130SpatialNoFill_1**
- Otherwise, select **Protocol > 3130SpatialFill_1**

Note: You do not need to fill the capillaries each time you perform a spatial calibration.

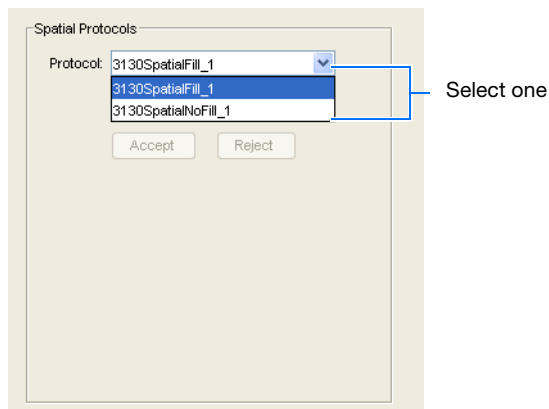

3. Click **Start**.

The calibration run lasts approximately:

- 2 min without filling the capillaries
- 6 min when filling the capillaries

Note: The spatial profile window turns black when you start a spatial calibration.

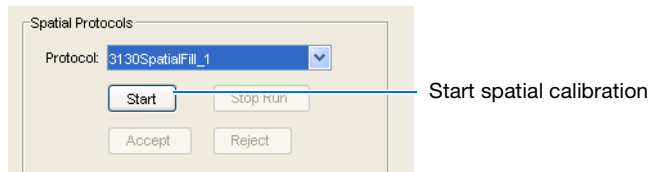

Notes

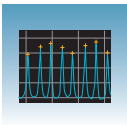

Evaluating a Spatial Calibration File

- Evaluate the spatial calibration profile using the following criteria:

Peak Attribute	Acceptable Criteria
Height	Similar heights for all peaks.
Orange crosses	One orange cross marking the top of every peak. No misplaced crosses.
Shape	Single sharp peak for each capillary. Small shoulders are acceptable.
Spacing	The difference between adjacent positions is 13 to 16 pixels. Theoretical spacing between capillaries is 15.

- Examine each row in the 16 or 4 Capillary Positions table and verify that the values in both the Left spacing and Right spacing columns range between 13 to 16 pixels.

To move the cross:

- Type a new value in the Positions (pixels) box for the capillary of interest.
- Click outside of that box or press **Enter**.

Spatial calibration profile for 3130x/ system

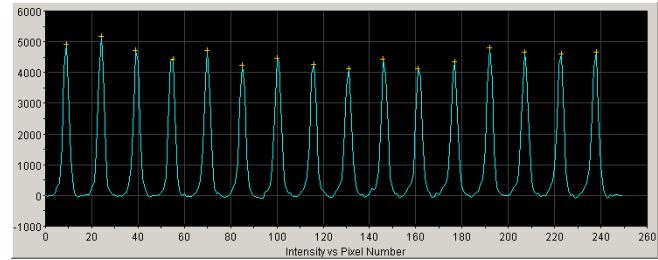

Spatial calibration profile for 3130 system

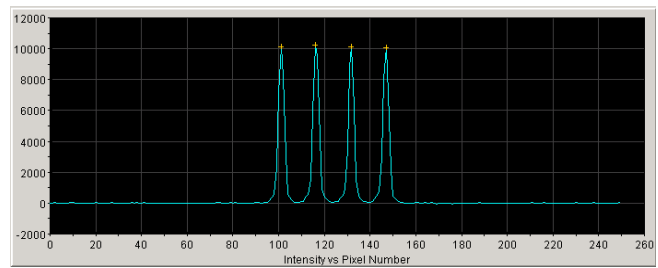

Capillary	Position (pixels)	Left spacing	Right spacing
1	10	0	15
2	25	15	16
3	41	16	15
4	56	15	16
5	72	16	15
6	87	15	15
7	102	15	15
8	117	15	15
9	132	15	16
10	148	16	15
11	163	15	15
12	178	15	16
13	194	16	15

Capillary	Position (pixels)	Left spacing	Right spacing
1	96	0	15
2	111	15	15
3	126	15	15
4	141	15	0

Left spacing and Right spacing columns

Notes _____

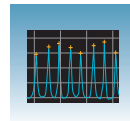

Accepting or Rejecting a Spatial Calibration

If the calibration:

- Passed, click **Accept** to write the calibration data to the database and .ini file.
- Failed, click **Reject**, then see the *Applied Biosystems 3130/3130xl Genetic Analyzers Maintenance, Troubleshooting and Reference Guide* (Part no. 4477854).

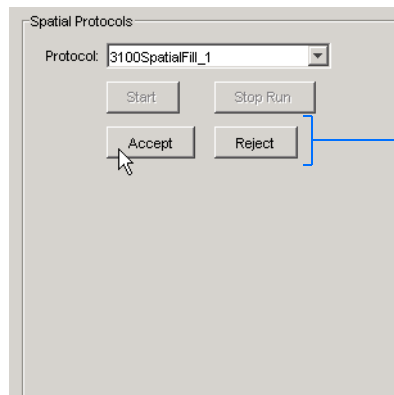

Accept and Reject buttons

Notes _____

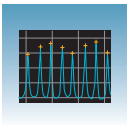

Examples of Spatial Profiles

Passing Profiles 3130 Genetic Analyzer

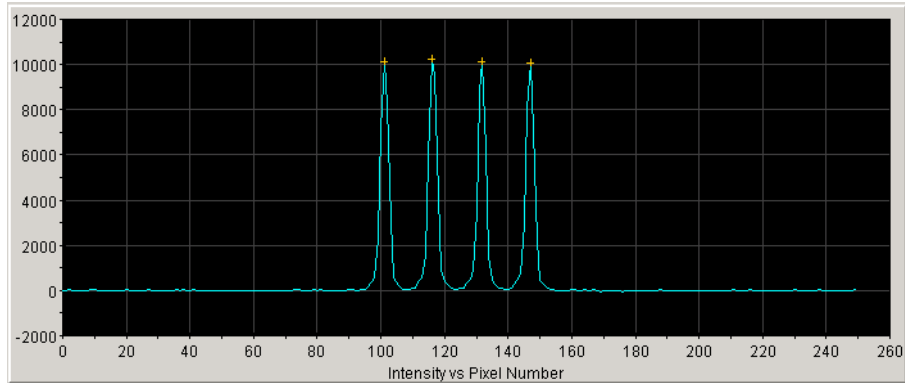

3130xl Genetic Analyzer

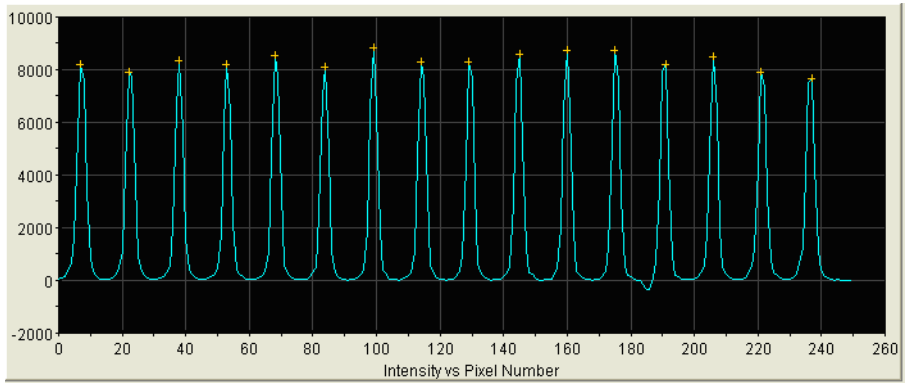

Failing Profile 3130xl Genetic Analyzer

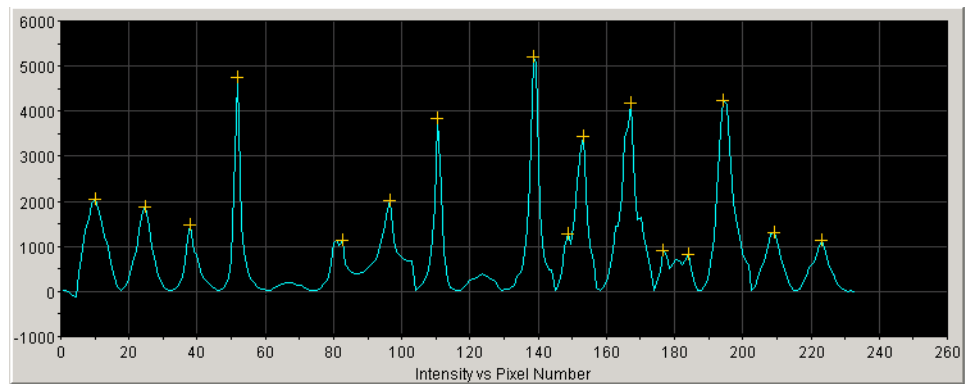

Notes _____

Performing a Spectral Calibration

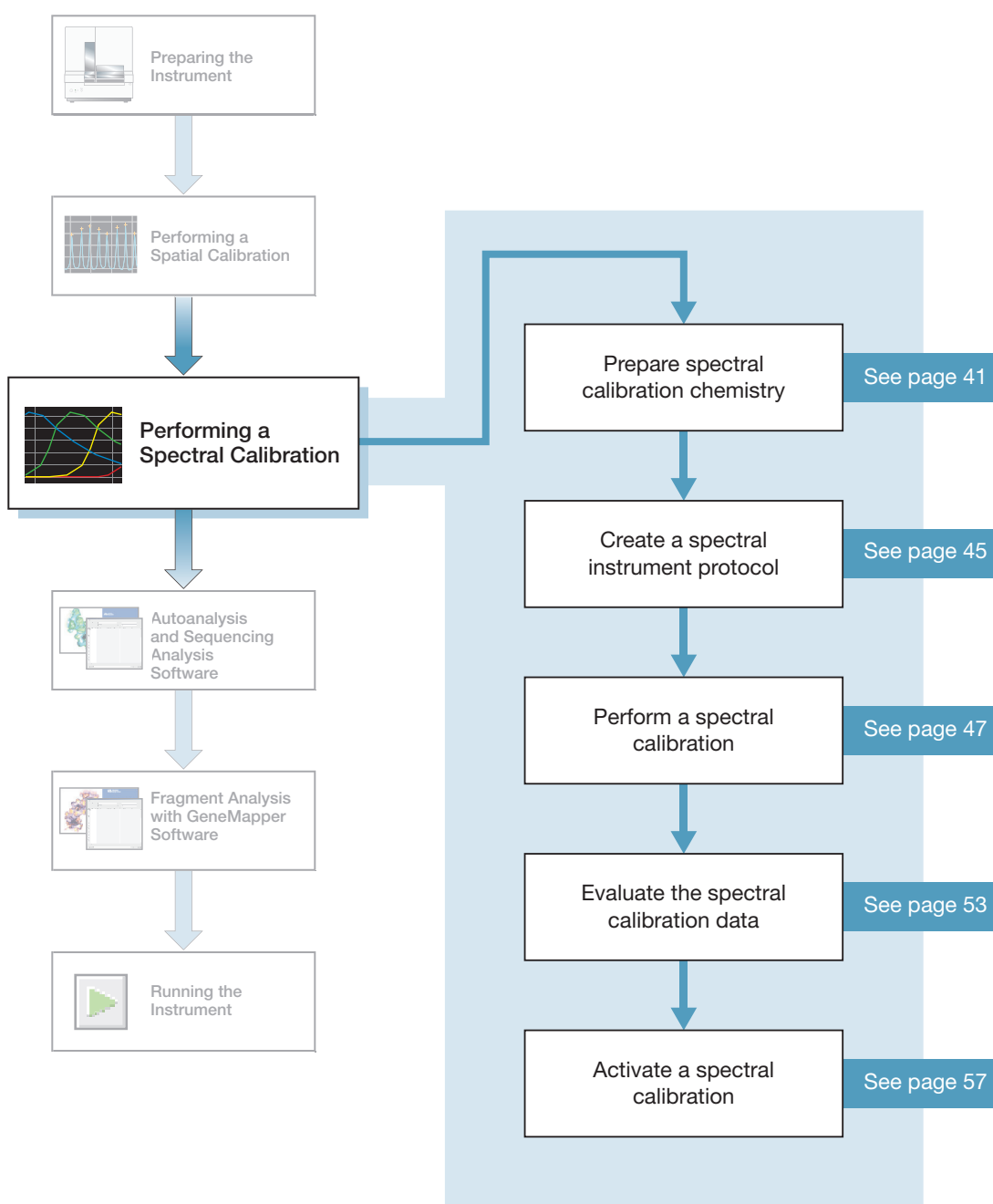

Notes

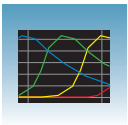

Spectral Calibration

A spectral calibration creates a matrix that is used during a run to reduce raw data from the instrument to the 4-dye or 5-dye data stored in sample files. Performing a spectral calibration is similar to performing a sample run except that calibration standards are run in place of samples and a spectral calibration module is used in place of a run module.

When to Perform the Calibration

Perform a spectral calibration:

- When you use a new dye set on the instrument
- When you change capillary array length or polymer type
- After the laser or CCD camera has been realigned/replaced by a service engineer
- If you begin to see a decrease in spectral separation (pull-up and/or pull-down peaks) in the raw or analyzed data
- Every time you install a new bottle of CAP polymer on the instrument.

IMPORTANT! CAP polymer is not compatible with any other POP polymer. Even trace amounts of CAP polymer with other polymers will irreparably damage the array and pump and void any service contract or warranty for the instrument. It is important to dedicate a capillary array, polymer block, and syringe for CAP polymer use exclusively. Also, buffer and water reservoirs should be cleaned every time a different polymer is used.

Note: We recommend that you run a spectral calibration each time that a new capillary array is installed. In 3130/3130x1 Data Collection software, if you install an array that is the same length as the previously installed array, the active spectral calibration still persists. For optimal data quality, perform a new spectral calibration before you perform regular runs.

What Happens?

Run the spectral standards in all 16 or 4 capillaries. The Data Collection software then:

- Collects the data and stores it in 16 or 4 separate temporary files
- Analyzes the data and generates a matrix for each capillary
- Stores the spectral calibration data for the dye set run

Changing Capillary Array Lengths and Polymer Type

For each dye set, a unique spectral calibration is used for each different capillary array length.

- For every sequencing dye set, you must create a separate spectral calibration for each capillary array length you use.
- For every fragment analysis dye set, you must create a separate spectral calibration for each capillary array length and polymer type combination you use.

See [“Activating a Spectral Calibration” on page 57](#), on how to switch calibrations once calibrations are performed for each dye set on each capillary length.

Notes _____

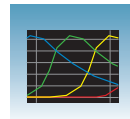

Types of Calibration Standards

There are two types of spectral calibration standards:

- **Matrix standards for fragment analysis or sequencing** – A tube that contains four or five fragments each labeled with a different single dye.
- **BigDye® v3.1 or BigDye® v1.1 Terminator Sequencing Standard** – A tube of a standard chemistry reaction that contains multiple labeled fragments in each of the four dyes

Dye Set Tables

Determine the correct dye set and matrix standard set for the application you are using by using the tables below.

Sequencing Chemistry Dye Sets, Calibration Standards, and Chemistry File

Sequencing Chemistry	Dye Set	Spectral Calibration Standard	Chemistry File
<ul style="list-style-type: none"> • BigDye® Terminator v3.1 Cycle Sequencing Kit • BigDye® Direct Cycle Sequencing Kit • dGTP BigDye® Terminator v3.0 Cycle Sequencing Ready Reaction Kit^a 	Z_BigDyeV3	BigDye® v3.1 Matrix Standards	Matrix Standard
		BigDye® v3.1 Terminator Sequencing Standard	Sequence Standard
<ul style="list-style-type: none"> • BigDye® Terminator v1.1 Cycle Sequencing Kit • BigDye® Primer Cycle Sequencing Kits • dGTP BigDye® Terminator v1.0 Cycle Sequencing Ready Reaction Kit^a 	E_BigDyeV1	DS-01 Matrix Standards	Matrix Standard
		BigDye® v1.1 Terminator Sequencing Standard	Sequence Standard
<ul style="list-style-type: none"> • dRhodamine Dye Terminator Cycle Sequencing Kit 		dRhodamine Matrix Standards Kit	Matrix Standard

^a dGTP kits are not supported on capillary electrophoresis instruments due to compressions on certain sequence context regions; you can run the kits if compression is not an issue.

Notes _____

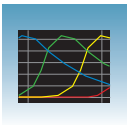

Fragment Analysis Dye Sets, Calibration Standards, and Chemistry File

Fragment Analysis Chemistry	Dye Set	Spectral Calibration Standard	Chemistry File
<ul style="list-style-type: none"> • Custom oligos 	D	DS-30 Matrix Standards	Matrix Standard
<ul style="list-style-type: none"> • Custom oligos 	D	DS-31 Matrix Standards	
<ul style="list-style-type: none"> • AFLP® Kits • Stockmarks® Kits 4-dye (bovine and canine) • AmpFℓSTR® COfiler® Kit • AmpFℓSTR® Profiler® Kit • AmpFℓSTR® Profiler Plus® Kit • AmpFℓSTR® Profiler Plus® ID Kit • AmpFℓSTR® SGM Plus® Kit • Other 4-Dye AmpFℓSTR® Kits 	F	DS-32 Matrix Standards	
<ul style="list-style-type: none"> • SNaPshot® Multiplex System 	E5	DS-02 Matrix Standards	
<ul style="list-style-type: none"> • Stockmarks® Kit 5-dye (equine) • Custom oligos • AmpFℓSTR® SEfiler™ Kit • AmpFℓSTR® Yfiler® Kit • AmpFℓSTR® Identifiler Direct® Kit • AmpFℓSTR® Identifiler Plus® Kit • AmpFℓSTR® MiniFiler Kit • AmpFℓSTR® NGM Kit • AmpFℓSTR® NGM Select® Kit • Other 5-Dye AmpFℓSTR Kits 	G5	DS-33 Matrix Standards	

Notes _____

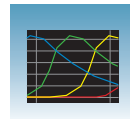

Preparing the Spectral Calibration Chemistry

Preparing the Calibration Standard

1. Prepare one of the following:



WARNING **CHEMICAL HAZARD.**

Formamide causes eye, skin, and respiratory tract irritation. It is a possible reproductive and birth defect hazard. Read the SDS, and follow the handling instructions. Wear appropriate protective eyewear, clothing, and gloves.

- BigDye™ Terminator v1.1 or v3.1 Sequencing Standard:
 - Remove a tube of the Sequencing Standard from the freezer.
 - Add 170 µL of Hi-Di™ formamide to resuspend the BigDye™ Terminator v1.1 or v3.1 Sequencing Standard.
- Sequencing or fragment analysis matrix standards:
 - Remove a tube of the matrix standard from the refrigerator.
 - Mix thoroughly, then spin briefly in a microcentrifuge.
 - Follow the matrix standard insert for matrix standard and Hi-Di™ formamide ratios.

2. Vortex thoroughly.
Briefly centrifuge the mixture.
3. Heat the standard tube at 95°C for 5 minutes to denature the DNA.
4. Cool the tubes on ice for 2 minutes.

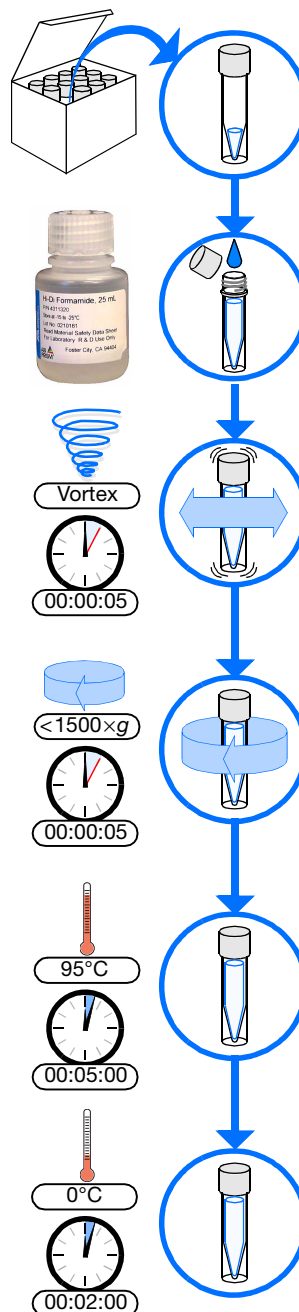

Notes _____

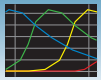

Loading Samples

WARNING CHEMICAL HAZARD. All chemicals on the instrument, including liquid in the lines, are potentially hazardous. Please read the SDS, and follow the handling instructions. Wear appropriate eyewear, protective clothing, and gloves when working on the instrument.

WARNING Do not use warped or damaged plates. 

Note: The efficient way to lay out samples in a plate is illustrated here. See [Appendix A, “Plate Mapping,”](#) for the relationship between sample position and priority in scheduled injections.

To load samples:

- Add the denatured samples to the wells of a 96- or 384-well reaction plate:
 - If using a 3130*x*L genetic analyzer:
 - 96-well plate** – Add 10 μ L of denatured standard to wells A1 through H2.
 - 384-well plate** – Add 5 μ L of denatured standard into alternating wells of the plate:
Row 1: A1, C1, E1, ...K1, M1, O1
Row 2: Empty
Row 3: A3, C3, E3, ...K3, M3, O3
 - If using 3130 genetic analyzer:
 - 96-well plate** – Add 10 μ L of denatured standard to wells A1, B1, C1 and D1.
 - 384-well plate** – Add 5 μ L of denatured standard into alternating wells of the plate:
Row 1: A1, C1, E1 and G1

Prepared standard
(from [step 4](#) on [page 41](#))

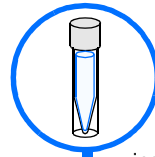

96-Well Plate
3130*x*L
instrument layout

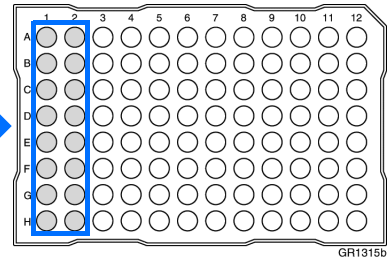

3130
instrument layout

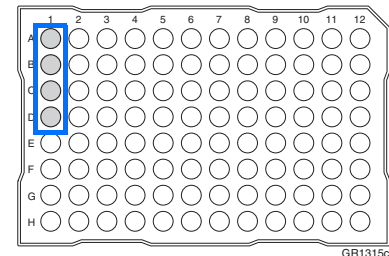

Add 10 μ L prepared standard

384-Well Plate
3130*x*L
instrument layout

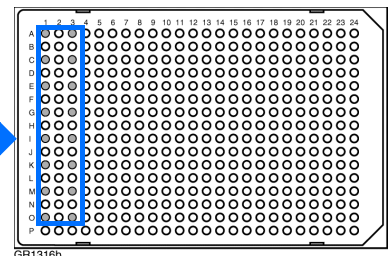

3130
instrument layout

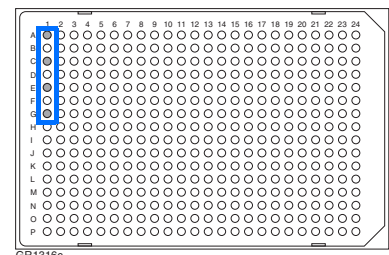

Add 5 μ L prepared standard
into alternating wells

Notes

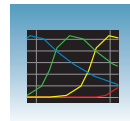

2. Seal the plate:
 - a. Place the plate on a clean, level surface.
 - b. Lay the septa flat on the plate.
 - c. Align the holes in the septa strip with the wells of the plate, then firmly press downward onto the plate.

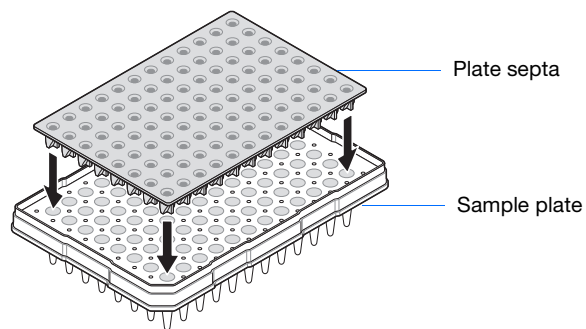

IMPORTANT! Do not heat plates that are sealed with septa.

3. To prevent damage to the capillary array, inspect the plate and septa to verify the septa fits snugly and flush on the plate.

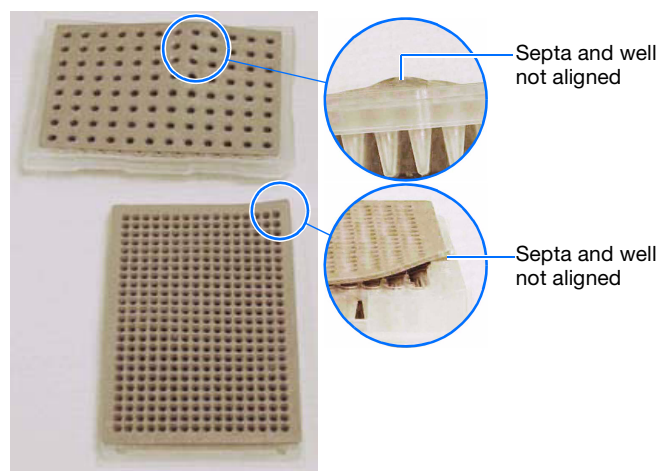

4. Briefly centrifuge the plate.

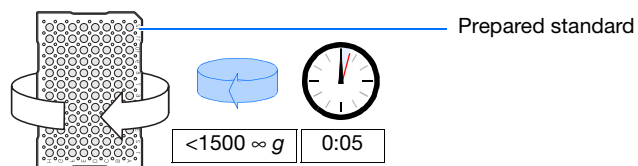

5. Remove the plate from the centrifuge and verify that each sample is positioned correctly in the bottom of its well.

If the reagents of any well contain bubbles or are not located at the bottom of the well, repeat [steps 4 and 5](#).

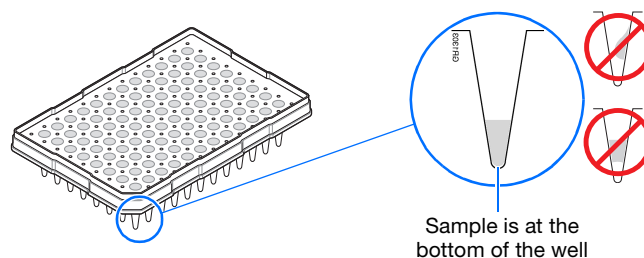

6. Leave the plate on ice until you are ready to prepare the plate assembly and place the assembly on the autosampler.

Notes _____

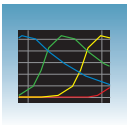

7. Assemble the plate assembly:

- a. Place the sample plate into the plate base.
- b. Snap the plate retainer onto the plate and plate base.

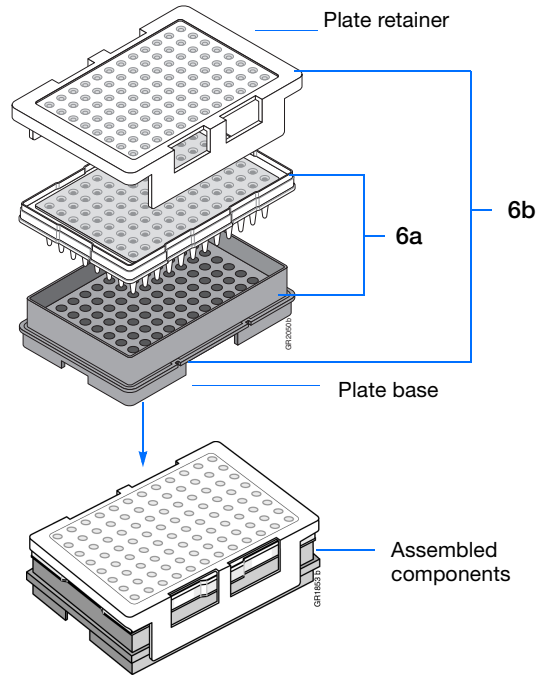

8. Verify that the holes of the plate retainer and the septa strip are aligned. If not, re-assemble the plate assembly (see [step 7](#)).

IMPORTANT! Damage to the array tips will occur if the plate retainer and septa strip holes do not align correctly.

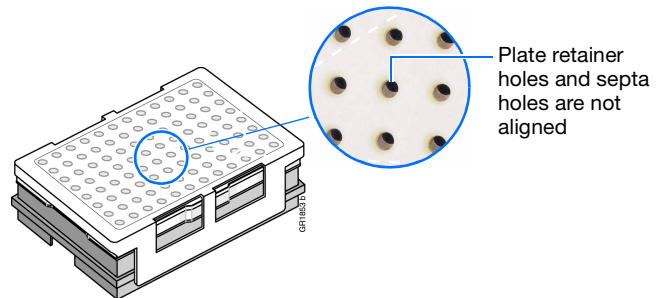

Notes _____

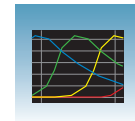

Creating a Spectral Instrument Protocol

1. In the tree pane of the Data Collection software, click **GA Instruments** > **ga3130xl** or **ga3130** > **Protocol Manager** to open the Protocol Manager window.

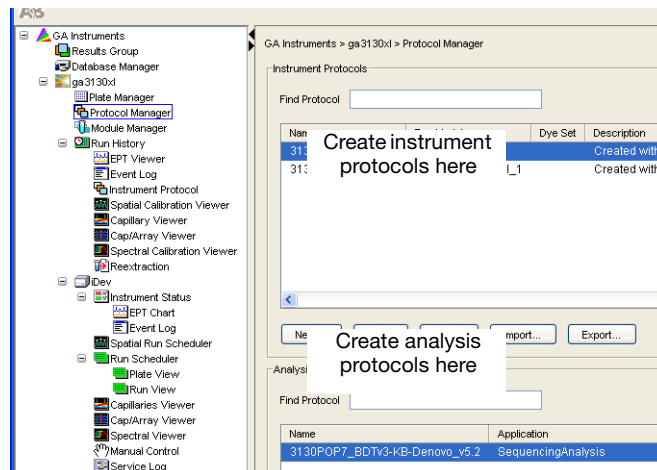

2. In the Instrument Protocols pane, click **New...**. The Protocol Editor dialog box opens.

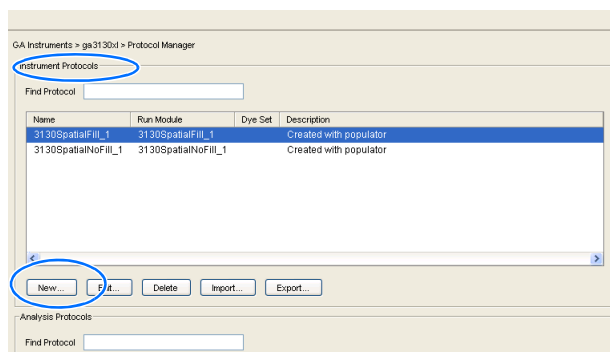

3. Complete the Protocol Editor dialog box.
 - a. Type a name for the protocol.
 - b. Type a description for the protocol (optional).
 - c. Select **Spectral** in the Type drop-down list.
 - d. Select the correct dye set for your run. See “Dye Set Tables” on page 39.

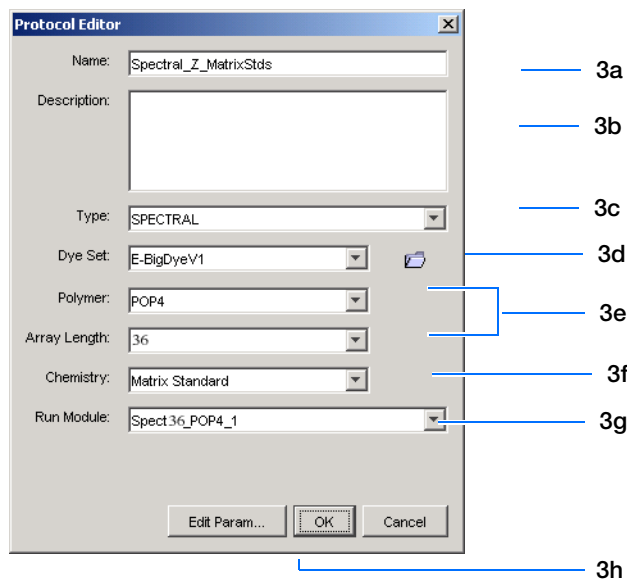

Notes

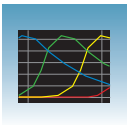

- e. Select the Polymer and Array Length from the appropriate drop-down list. See table, “Polymer, Array Length and Spectral Run Modules.”
- f. Select your chemistry file in the Chemistry drop-down list. Failure to select the correct chemistry file for your spectral calibration samples results in a failing spectral run. See “Dye Set Tables” on page 39 for matching chemistry files.

Note: The chemistry file for fragment analysis dye sets defaults to the Matrix Standard.

- g. In the Run Module drop-down list, select the run module. See the table “Polymer, Array Length and Spectral Run Modules.”

Note: The modules list is filtered based on the polymer type, then the array length you selected in [step e](#). You may have only one run module option available.

- h. Click .

Polymer, Array Length and Spectral Run Modules

Polymer Type	Array Length (cm)	Run Module
POP-4	22	Spect22_POP4
	36	Spect36_POP4
		SpectSQ36_POP4
	50	Spect50_POP4
80	Spect80_POP4	
POP-6	36	Spect36_POP6
	50	Spect50_POP6
POP-7	36	Spect36_POP7
	50	Spect50_POP7
	80	Spect80_POP7
CAP	36	Spect36_CAP

Notes _____

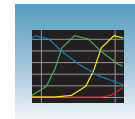

Performing a Spectral Calibration

Creating the Plate Record

1. In the tree pane of the Data Collection software, click **GA Instruments** > **ga3130x/** or **3130** > *instrument name* > **Plate Manager**.

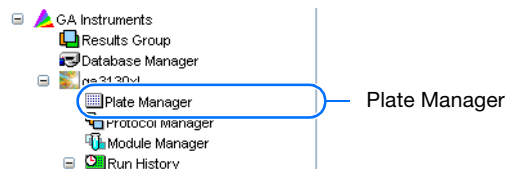

2. Click **New...** to open the New Plate dialog box.

3. Complete the New Plate dialog box:

- Enter a name for the plate.
- Optional: Enter a description for the plate record.
- In the Application drop-down list, select **Spectral Calibration**.
- In the Plate Type drop-down list, select **96-Well** or **384-Well**
- Enter a name for the owner.
- Enter a name for the operator.
- Click **OK**.

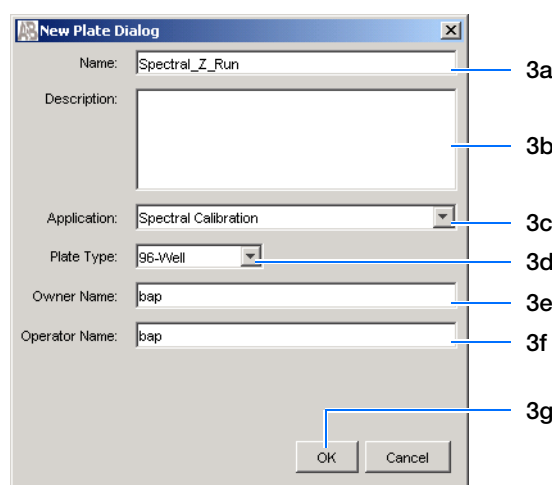

4. In the Spectral Calibration Plate Editor dialog box:

- In the Sample Name column, enter a sample name, then click the next cell. The value 100 automatically displays in the Priority column.
- Optional: In the Comments column, enter any additional comments or notations for the sample at the corresponding position of the plate.
- In the **Instrument Protocol 1** column, select a protocol from the list or create a new protocol (see [step 2 on page 45](#))

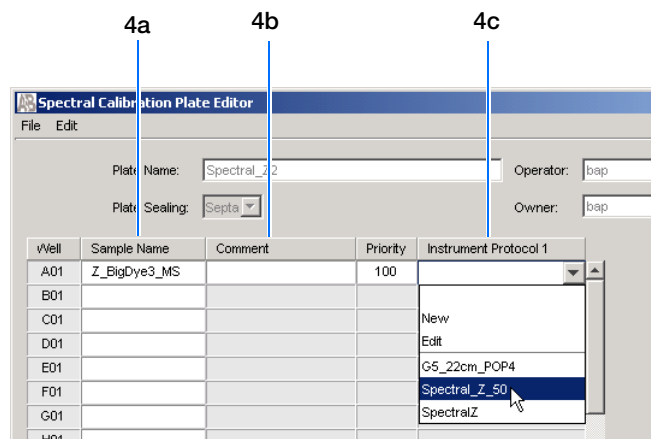

5. Highlight the entire row.

Notes

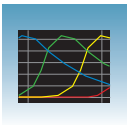

6. Select Edit > Fill Down Special.

Based on your plate type (96- or 384-well) and capillary array (16 or 4 capillaries), the software automatically fills in the appropriate well numbers for a single run.

7. Click .

You have successfully created the plate record for the spectral calibration plate.

Note: If multiple cells are selected for copying, select the same number of corresponding target cells before you execute the Paste command.

Note: The Plate Editor Copy and Paste functionality is supported only within one plate editor. To copy and paste the contents of one plate to another plate, use the Duplicate ... button on the Plate Manager dialog box.

Note: All plate information must be valid to use the duplicate plate function. If information is not valid, an empty plate will result.

Note: Ensure that processed run information is valid before adding another sample run to the plate. A new sample run cannot be created if data is not validated.

Edit	
Fill Down	Ctrl+D
Copy	Ctrl+C
Paste	Ctrl+V
Clear row(s)	Shift+Delete
Fill Down Special	Alt+D
Add Sample Run	Alt+A

Notes _____

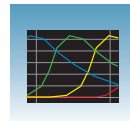

Placing the Plate Assembly into the Instrument

1. Verify the oven and front doors are closed.
2. Press the Tray button and wait for the autosampler to stop at the forward position.
3. Open the front doors.
4. Place the plate assembly on the autosampler in position A or B for the 3130*x*/ genetic analyzer and position B for the 3130 genetic analyzer.

Note: There is only one orientation for the plate, with the notched end of the plate base away from you.

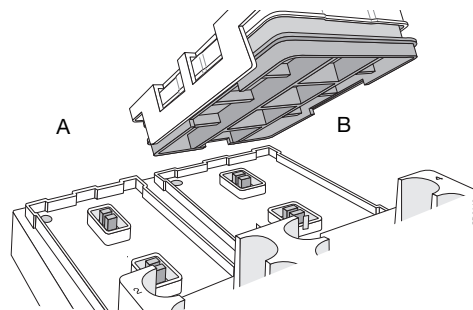

3130*x*/ genetic analyzer

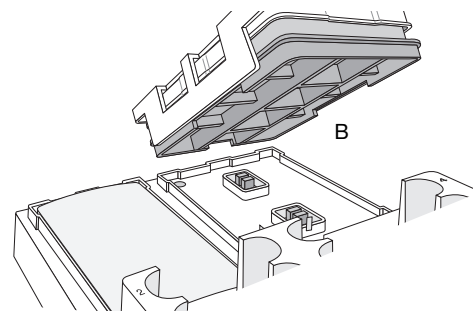

3130 genetic analyzer

5. Ensure the plate assembly fits flat in the autosampler. Failure to do so may allow the capillary tips to lift the plate assembly off of the autosampler.
6. Close the instrument doors.

Note: Closing the doors returns the autosampler to the home position, placing the tips of the capillaries in buffer.

Notes

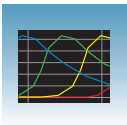

Running the Spectral Calibration Plate

1. In the tree pane of the Data Collection software, click **GA Instruments** > **ga3130xl** or **3130** > *instrument name* > **Run Scheduler** > **Plate View**.

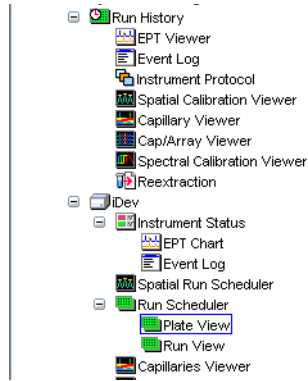

2. Search for your plate record. There are two options:

- Select **Barcode** in the Type of Search drop-down list.
 - In the **Scan or Type Plate ID** text box, type in the plate name and click **Search** to find the plate.
 - Or if you have a limited number of plates in the database, click **Find All**.

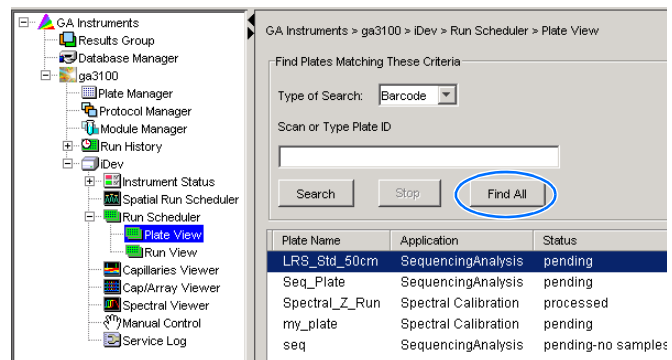

All plates in the database display in plate record section.

- Perform an advanced search by selecting **Advanced** in the Type of Search drop-down list.
 - Use the drop-down list to define search conditions for a category or multiple categories (Run Name, Results Group Name, Plate ID, Plate Name, Type, Size, etc.)

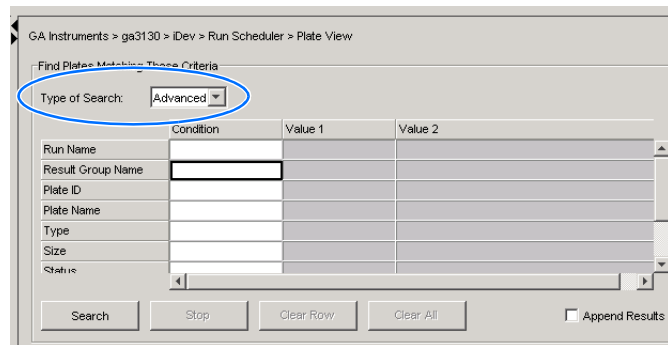

Note: Your entry for Plate Name will also be set as the Plate ID.

- For each category with a condition selected, type a value (primary search string) in the Value 1 column.
- Click **Search**. All plates in the database that match the search criteria display in the plate record section.

Notes

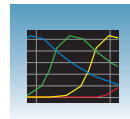



3. Link the plate.

- a. Select the plate record you want to run.
- b. Click the plate position indicator that matches the plate you want linked.

The plate map color will change from yellow to green when it is successfully linked.

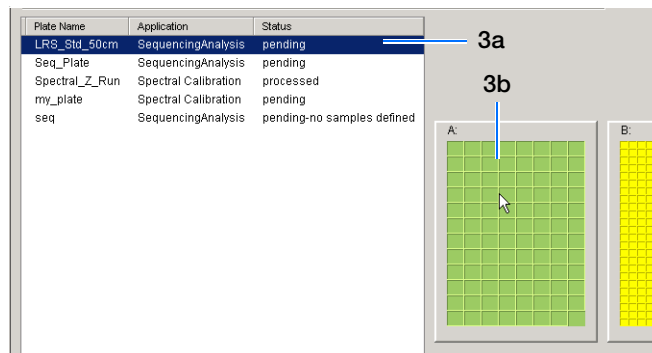
Note: The 3130 genetic analyzer has only one plate position (Bay B) to link a plate record.



4. In the toolbar of the Data Collection software window, click  to begin the run.

5. The Processing Plates dialog box opens. Click .

Note: The instrument may pause before running the plate to raise the oven temperature.

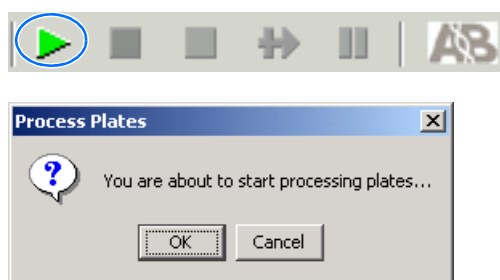

Spectral Calibration Approximate Run Times

Capillary Length (cm)	Run Type	Ramp Time (min)	Approximate Total Run Time (min)
22	Spect22_POP4	3	21
36	Spect36_POP4	10	35
	SpectSQ36_POP4	10	48
	Spect36_POP6	10	54
	Spect36_POP7	5	30
	Spect36_CAP	a	a
50	Spect50_POP4	7.5	110
	Spect50_POP6	10	95
	Spect50_POP7	7.5	52
80	Spect80_POP4	10	140
	Spect80_POP7	10	120

a Time is dependent on customized polymer formulation.

Notes

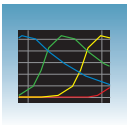

Viewing the Pass/Fail Status After the Run

After the spectral calibration run, the pass or fail status of each capillary is recorded in the Event Log section of the Instrument Status window.

1. In the tree pane of the Data Collection software, click **GA Instruments > ga3130xl or ga3130 > instrument name > Instrument Status > Event Log.**
2. In the Event Messages section of the window, view the status of each capillary.

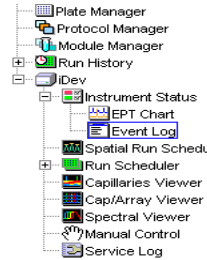

Note: The window below shows the dye set G5 status results.

Event Messages					Cap #	Pass/fail status	Q-value	Condition Number
Type	Date	Time	Publisher	Description				
Info	07/07/03	15:41:31	iDev	Instrument Saving spectral calibration data				
Info	07/07/03	15:41:30	iDev	Saving spectral calibration data				
Info	07/07/03	15:41:30	iDev	Capillary 16 successfully calibrated : q=0.988 c=9.12				
Info	07/07/03	15:41:30	iDev	Capillary 15 successfully calibrated : q=0.986 c=9.15				
Info	07/07/03	15:41:30	iDev	Run completed				
Info	07/07/03	15:41:30	iDev	Capillary 14 successfully calibrated : q=0.986 c=9.01				
Info	07/07/03	15:41:30	iDev	Capillary 13 successfully calibrated : q=0.988 c=8.99				
Info	07/07/03	15:41:29	iDev	Capillary 12 successfully calibrated : q=0.989 c=8.87				

Each capillary should have a Q-value above 0.95 and a Condition number range shown in the table.

Note: If the entire spectral calibration failed, see the *Applied Biosystems 3130/3130xl Genetic Analyzers Maintenance, Troubleshooting and Reference Guide* (Part no. 4477854) for troubleshooting information.

Dye Set	Acceptable Condition Number Range	Q-Value
Sequencing Analysis		0.95
Z_BigDyeV3	3 to 5	
E_BigDyeV1		
Fragment Analysis		
D	4 to 8.5	
F	6 to 12	
E5	2.5 to 4	
G5	8.5 to 14.5	
Any 4- or 5-Dye set	1 to 20	0.80

Notes

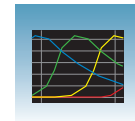

Evaluating the Spectral Calibration Data

IMPORTANT! Evaluate the spectral calibration profile for each capillary, even if the Spectral Calibration Results box indicates that they passed.

Note: Pages 59 to 60 for examples of passing sequencing spectral calibration profiles. See pages 61 to 62 for examples of passing fragment analysis spectral calibration profiles.

Evaluating the Spectral Profile and Raw Data

1. In the tree pane of the Data Collection software, click **GA Instruments** > **ga3130xl** or **ga3130** > **instrument name** > **Spectral Viewer**.

Plate diagram
Click each cell to verify the spectral profile and raw data

Spectral profile

Raw data (matrix standards)

View, rename, or set the active spectral calibration for the selected dye set

Notes

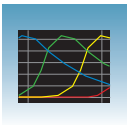

- In the Dye Set drop-down list, select the dye set you just created.

Note: If the spectral calibration failed (no spectral profiles are created), see the *Applied Biosystems 3130/3130xl Genetic Analyzers Maintenance, Troubleshooting and Reference Guide* (Part no. 4477854) for more information.

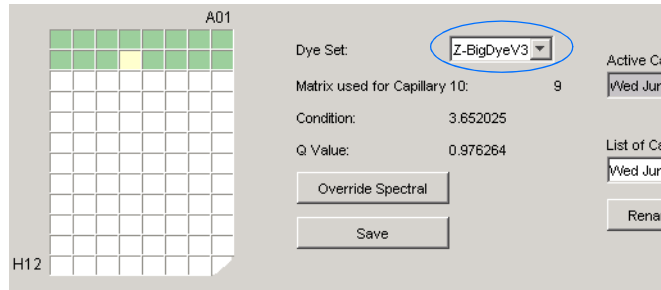

- In the plate diagram, select a well on the plate diagram to view the capillary spectral results.

Note: A failing capillary is automatically assigned the spectral profile of its nearest passing capillary.

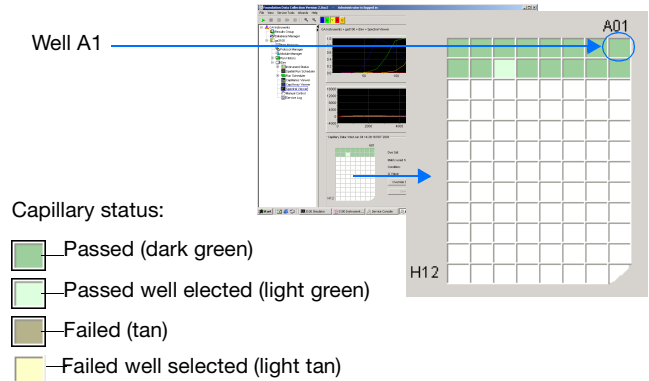

- Evaluate the spectral profile and raw data for the selected capillary:

- Verify that the order of the peaks in the spectral profile from left to right are:
 - 4-dye: blue-green-yellow-red
 - 5-dye: blue-green-yellow-red-orange

Do the peaks in the profile appear in the correct order?	Then
Yes	Go to step b.
No	The calibration run has failed. See the <i>Applied Biosystems 3130/3130xl Genetic Analyzers Maintenance, Troubleshooting, and Reference Guide</i> (Part no. 4477854).

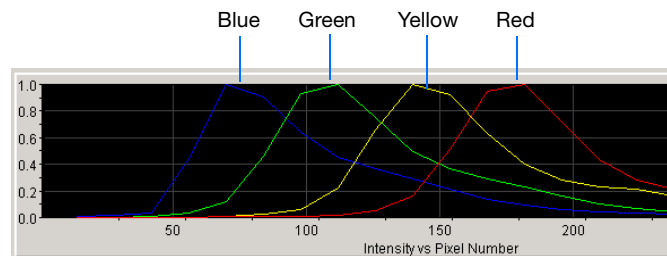

Example of a 4-dye spectral profile

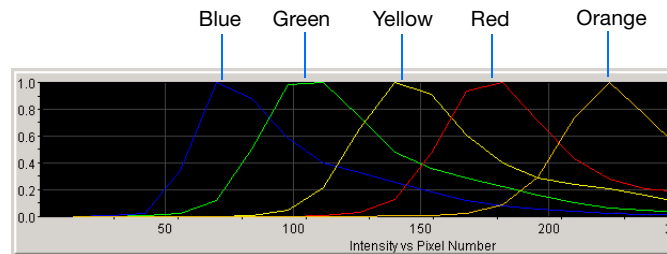

Example of a 5-dye spectral calibration profile

Notes _____

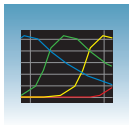

- b. Verify that the order of the peaks in the raw data profile from left to right are:

Sequencing

- 4-dye: red-yellow-blue-green

Fragment Analysis

- 4-dye: red-yellow-green-blue
- 5-dye: orange-red-yellow-green-blue

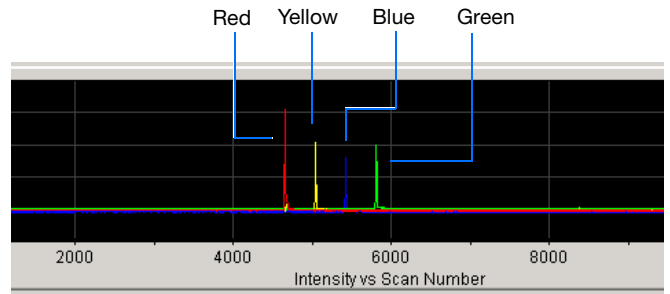

Example of a 4-dye sequencing raw data profile

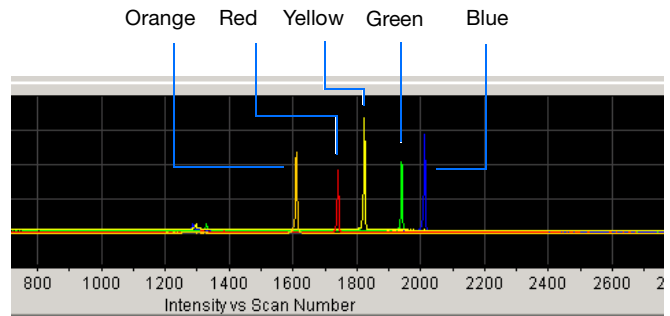

Example of a 5-dye fragment analysis raw data profile

Are peaks in the wrong order or extraneous peaks adversely affecting the spectral profile?	Then
Yes	The calibration run has failed. See the <i>Applied Biosystems 3130/3130xl Genetic Analyzers Maintenance, Troubleshooting, and Reference Guide</i> .
No	Go to step c .

- c. Verify that the peaks in the spectral profile do not contain gross overlaps, dips, or other irregularities (see “Magnifying the Spectral Profile or Raw Data” on page 56).

Are the peaks separate and distinct?	Then
Yes	The capillary has passed. Go to step 5 .
No	The calibration run has failed. See the <i>Applied Biosystems 3130/3130xl Genetic Analyzers Maintenance, Troubleshooting, and Reference Guide</i> .

Peaks are distinct, regular and in the proper order – pass

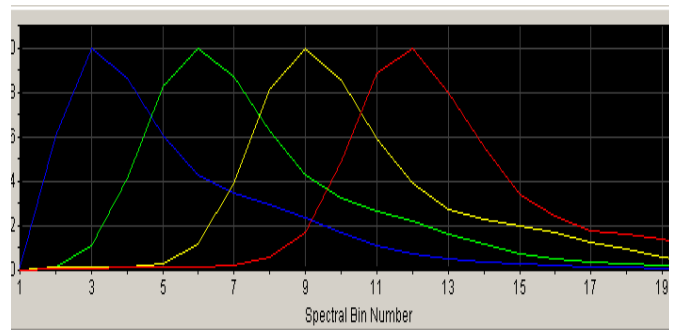

Red peak is not distinct, regular or in the proper order – fail

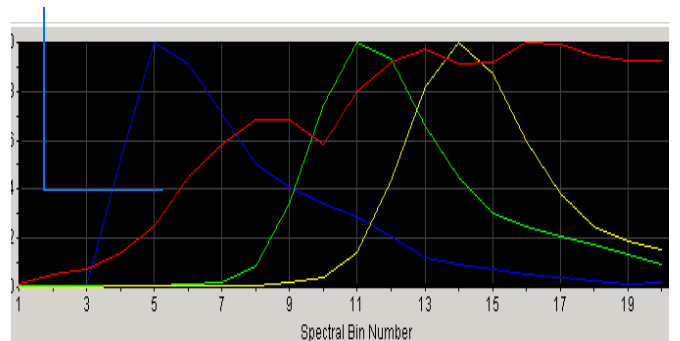

Notes

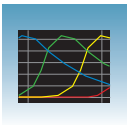

5. Repeat steps 3 and 4 for each capillary in the array.
6. Optional: Rename the spectral run. The spectral file default name is the day, date, and time of the run.

a. Click **Rename**.

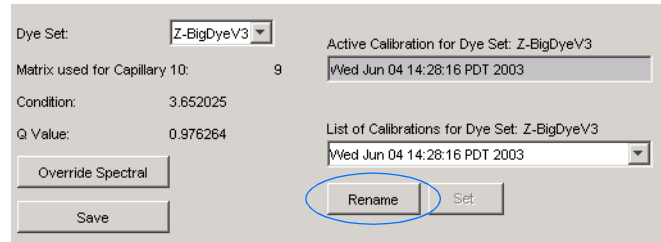

b. In the Rename Calibration dialog box, enter a descriptive name for the spectral calibration including the dye set, array length and polymer type (optional).

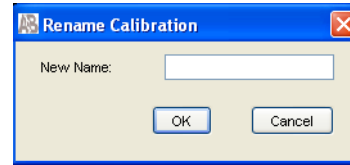

c. Click **OK**.

Magnifying the Spectral Profile or Raw Data

1. In the tree pane of the Data Collection software, click **GA Instruments > ga3130xl** or **ga3130 > instrument name > Spectral Viewer**.
2. In the spectral profile or raw data display, click-drag the cursor to create a box around the area of interest.
3. Release the mouse button.
The Data Collection software displays the selected region.
4. Press **r** to reset the view.

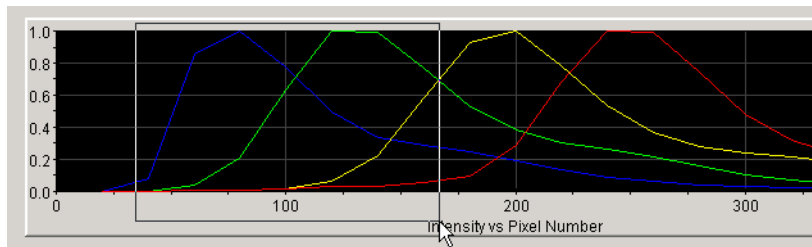

Selecting an area to magnify in a spectral profile

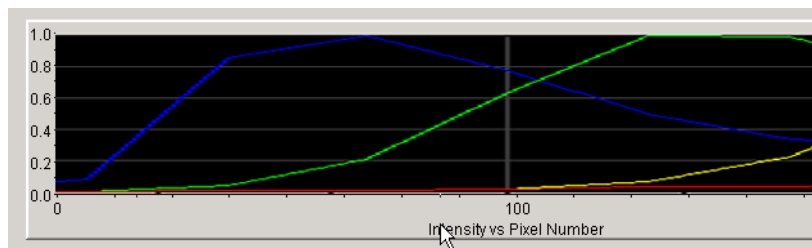

Magnified area of that spectral profile

Notes

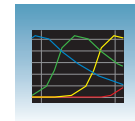

Activating a Spectral Calibration

IMPORTANT! A run cannot start unless a calibration file that matches the dye set and capillary array length combination to be used for the run, is active.

IMPORTANT! While the software does not force you to recalibrate spectrally after changing polymer types, it is strongly recommended that you perform a spectral calibration after a polymer type change.

IMPORTANT! Whenever you install or replace an array or switch dye sets, you must either set the active spectral calibration for that dye set and array length combination or perform a new spectral calibration and then activate it.

When you install an array that is a different length or type from what you were using previously, all spectral calibrations are voided. If a previous spectral calibration for the new array/new condition does not exist, you must run a new spectral calibration. If a previous calibration exists, go to the Spectral Viewer and choose a past calibration to set as an active spectral calibration before you proceed with regular runs, even though spectral profiles are displayed.

You cannot link or run a plate unless the dye set used in the plate has been set in the Spectral Viewer. Furthermore, when a plate is running, the Set Active Spectral Calibration function is inactive. Spectral Calibrations can be set only during the idle or ready mode.

IMPORTANT! Every new spectral calibration is automatically the active one for that dye set.

You may activate a previously created spectral calibration for a run as long as the calibration matches the dye set and array length combination (and, for fragment analysis, the polymer type) that you wish to use. Use an active spectral calibration for:

- Sequencing analysis applications that require a separate spectral calibration (for the same dye set) for different capillary array lengths and polymer type
- Fragment analysis applications that require a separate spectral calibration (for the same dye set) for different capillary array lengths and polymer type
- Repeat spectral calibrations where the original calibration is better than the second one

Notes _____

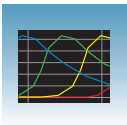

Setting an Active Spectral Calibration

1. In the tree pane of the Data Collection software, click
 GA Instruments > **ga3130xl** or **ga3130** >
 instrument name > **Spectral Viewer**.

IMPORTANT! If the Spectral Viewer window is blank and deactivated, then either:

– The spectral calibration for that dye set is not in the database

or,

– You changed the array length and you do not have a spectral calibration file activated for that dye set and array length combination.

2. In the Dye Set drop-down list, select a dye set.

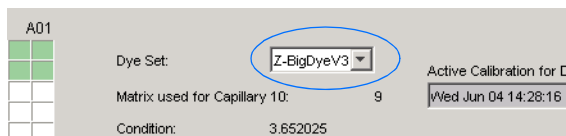

3. In the List of Calibrations for Dye Set drop-down list, select the spectral calibration you want to use. The spectral profile and raw data is displayed.

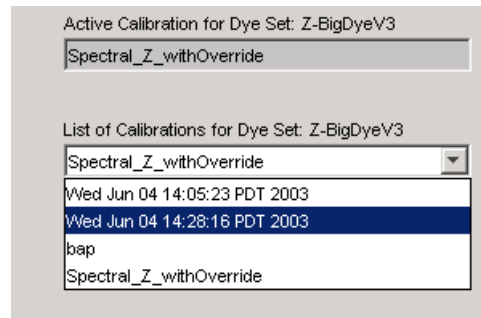

4. If the spectral calibration is acceptable, then click . Otherwise, run a new spectral calibration.

Notes _____

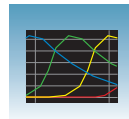

Examples of Passing Sequencing Spectral Calibrations

Dye Set Z Created
from Matrix
Standard

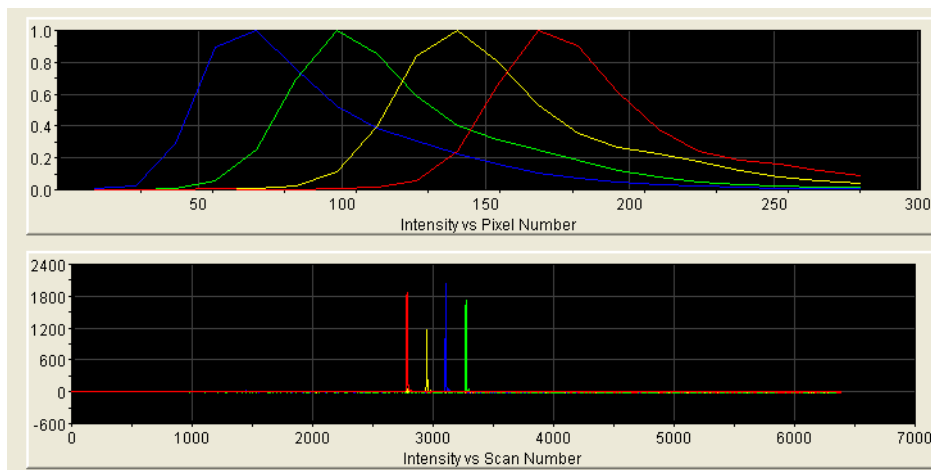

Dye Set Z Created
from a
Sequencing
Standard

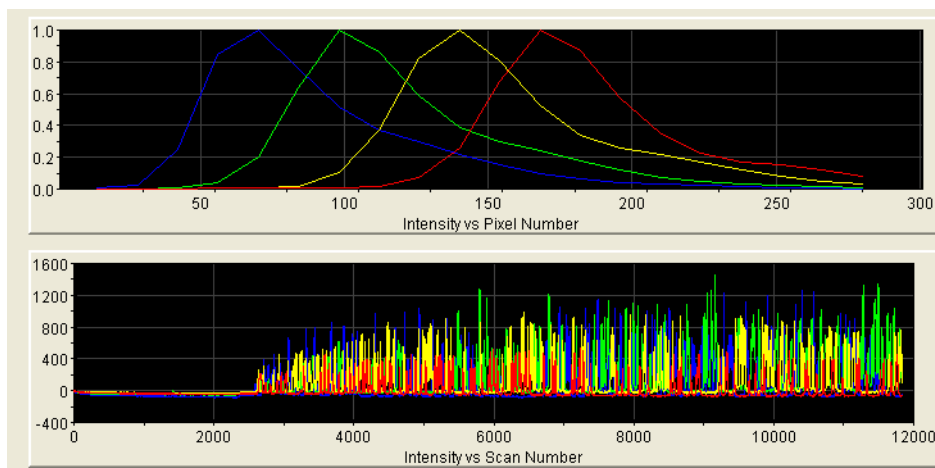

Notes _____

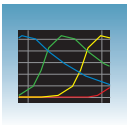

**Dye Set E Created
from Matrix
Standard Set
DS-01**

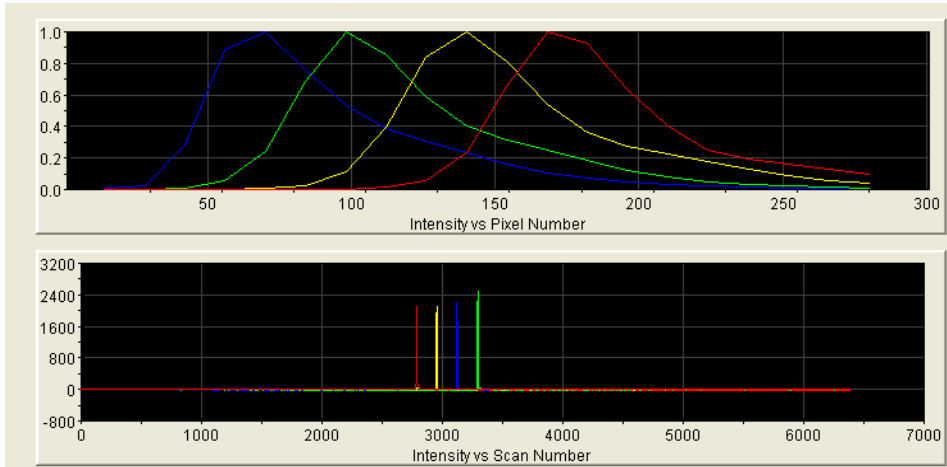

**Dye Set E Created
from a
Sequencing
Standard**

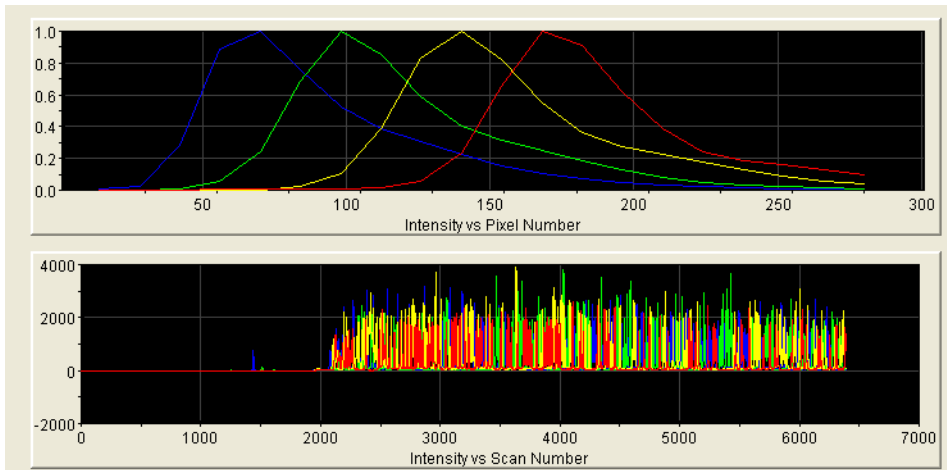

Notes _____

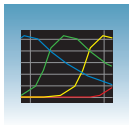

Examples of Passing Fragment Analysis Spectral Calibrations

**Dye Set G5
Created from
Matrix Standard
Set DS-33**

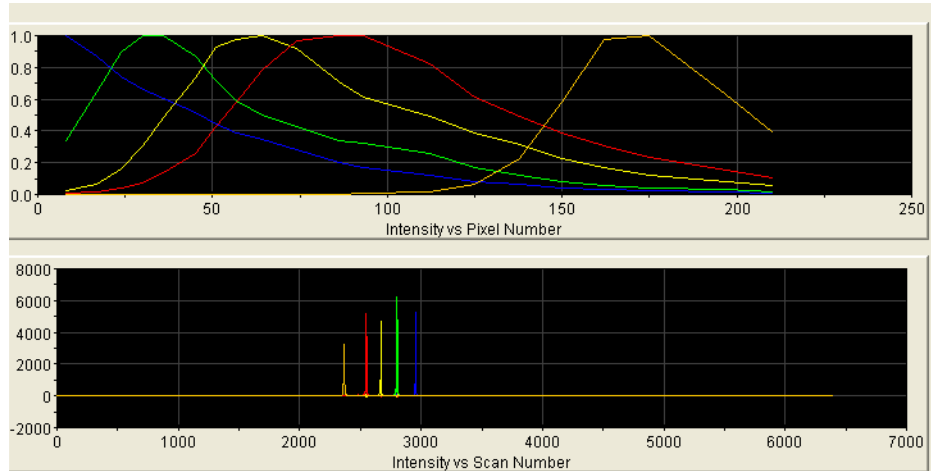

**Dye Set F Created
from Matrix
Standard Set
DS-32**

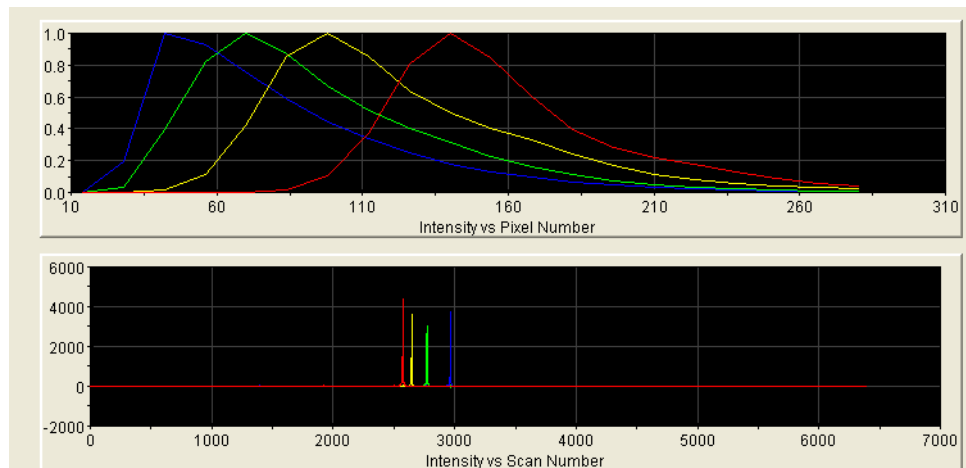

Notes _____

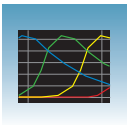

Dye Set D
Created from
Matrix Standard
Set DS-30

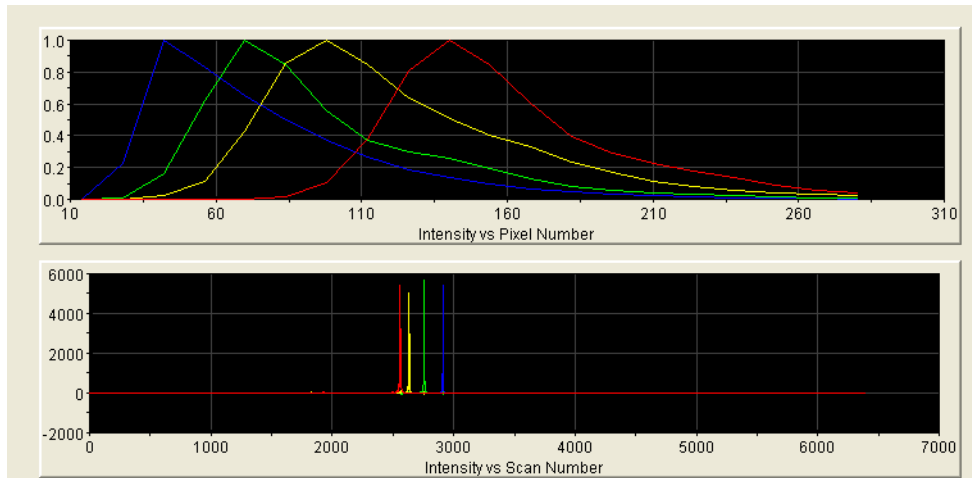

Dye Set E5
Created from
Matrix Standard
Set DS-02

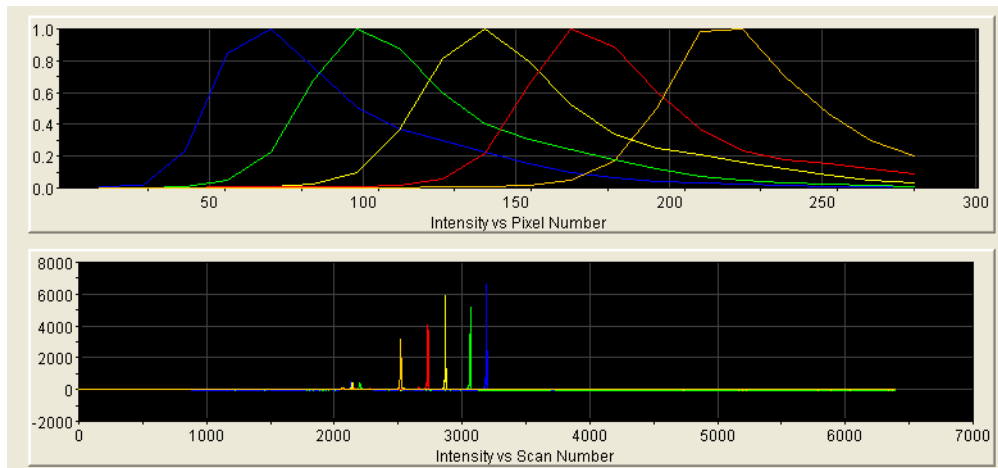

Notes _____

Autoanalysis and Sequencing Analysis Software

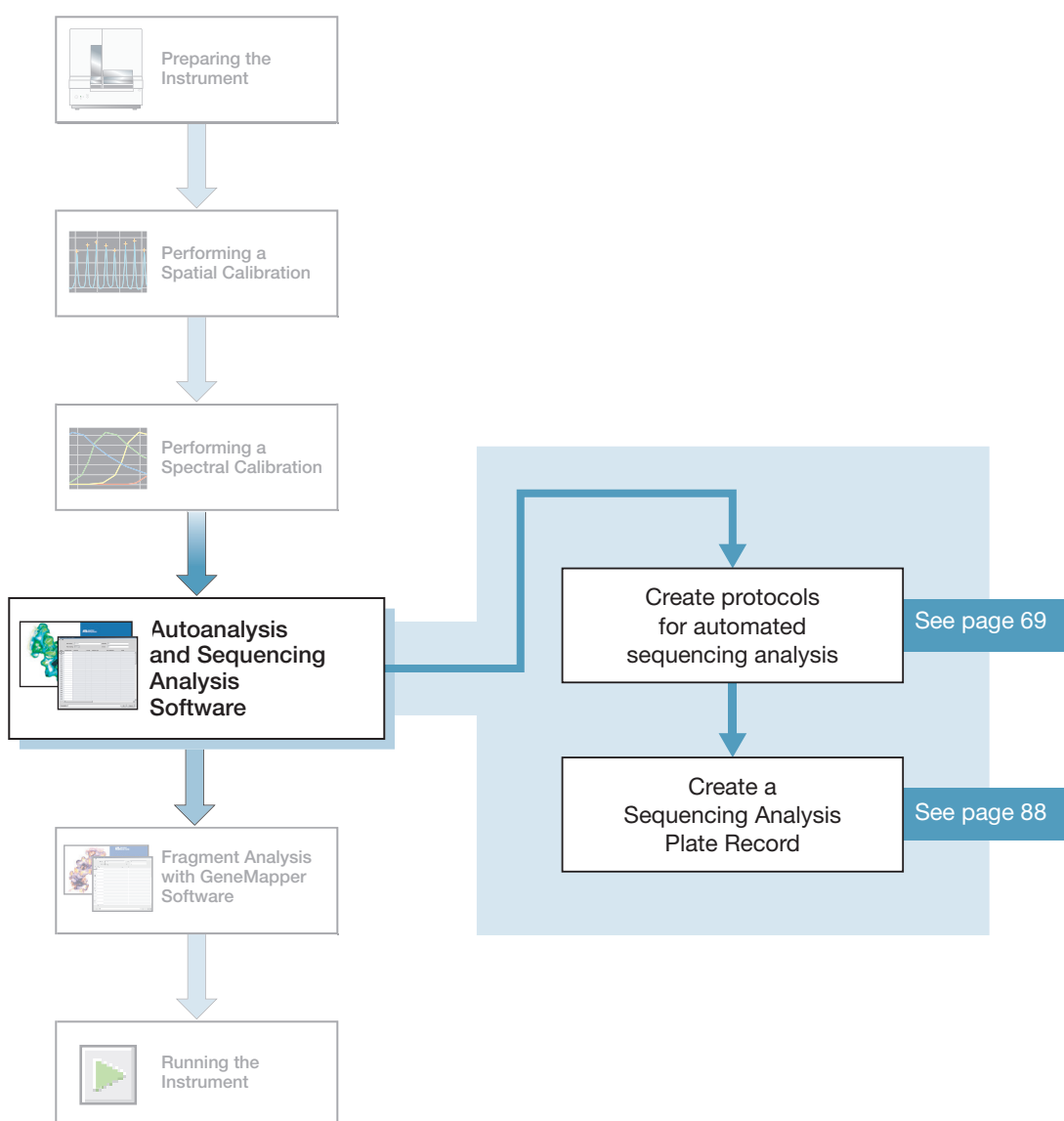

Notes _____

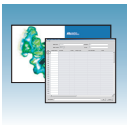

Sequencing Analysis Software

See the *Applied Biosystems DNA Sequencing Analysis Software 6 User Guide* (Part no. 4474239) for details on sequencing analysis.

Analyze your sequencing samples automatically using autoanalysis or manually.

Autoanalysis Perform autoanalysis of sequencing samples using features of the 3130 Series Data Collection Software 4 and Sequencing Analysis Software 6 or higher.

The Sequencing Analysis software must be installed and registered with the 3130 Series Data Collection Software 4 before you can create files required for autoanalysis.

Autoanalysis can only be performed on the computer that collected the sample files. If you want to edit/review results on another computer, transfer the analysis protocol to the Sequencing Analysis Software database. To analyze samples on another computer, transfer the sample files to that location.

Manual Analysis If the run is not set up for autoanalysis, data can be analyzed after the run with Sequencing Analysis Software 6 on the instrument computer or alternate computer. Limited support is offered for older instruments of Sequencing Analysis Software.

File-Naming Convention Some alphanumeric characters are not valid for user names or file names. Do not use the characters below:

spaces
\\ : * ? " < > |

IMPORTANT! An error message is displayed if you use any of these characters. You must remove the invalid character to continue.

Notes _____

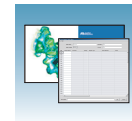

About Plate Records and Sequencing Analysis

Overview Plate records are data tables in the instrument database that contain the following information:

- Plate name, type, and owner
- Position of the sample on the plate (well number)
- Sample Name
- Mobility file (in Analysis Protocol)
- Comments about the plate and about individual samples
- Name of the run module and Dye set information (run modules specify the conditions to run the samples)
- Name of the Analysis Protocol

Note: A plate record is similar to a sample sheet or an injection list that you may have used with other Applied Biosystems Genetic Analyzer instruments.

When to Create a Plate Record

Create a plate record for each plate of samples for the following types of runs:

- Spectral calibrations
- Sequencing Analysis Software
- SeqScape Software analysis
- GeneMapper® software
- Mixed (sequencing and fragment analysis samples – see the *Applied Biosystems 3130/3130xl Genetic Analyzers Maintenance, Troubleshooting, and Reference Guide* for creating a mixed plate record)

Autoanalysis with Sequencing Analysis Software 6 is supported, whereas autoanalysis with GeneMapper and SeqScape Software is no longer supported.

Note: For runs to begin, you must create a plate record for and link it to a plate loaded on the instrument. However, you can create plate records for new plates while a run is in progress.

About a Sequencing Analysis Plate Record

The Plate Editor displays an empty plate record for the application selected in the New Plate dialog box. The data fields within a given plate record vary depending on the selected application. This section describes the sequencing analysis plate record's data fields.

Notes _____

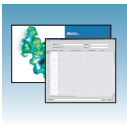

The table below describes required plate editor fields:

Parameters	Description	See Page
Instrument Protocol	Contains the run module and dye set needed to run the instrument.	69
Analysis Protocol	Contains everything needed to analyze sequencing data.	72
Results Group	Defines the file type, the file name, file save locations, analysis software and autoanalysis.	81

Elements of a Sequencing Analysis Plate Record

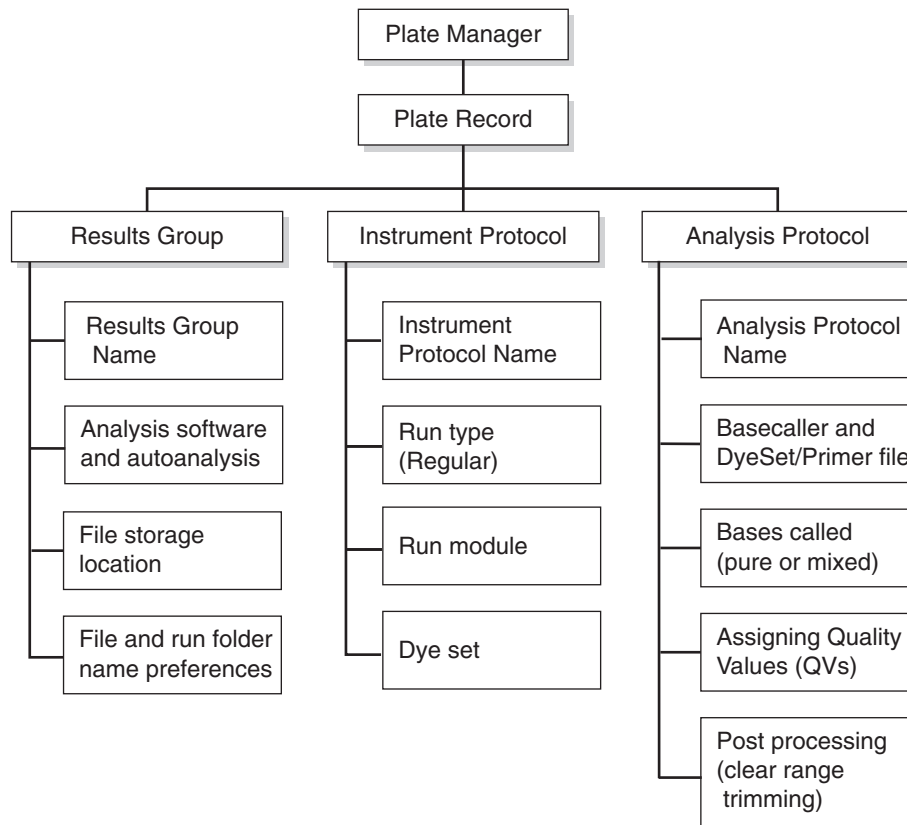

IMPORTANT! For data collection and autoanalysis to succeed, each run of samples must have an Instrument Protocol, an Analysis Protocol, and a Results Group assigned within a plate record.

Notes _____

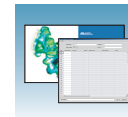

A Blank Sequencing Analysis Plate Record

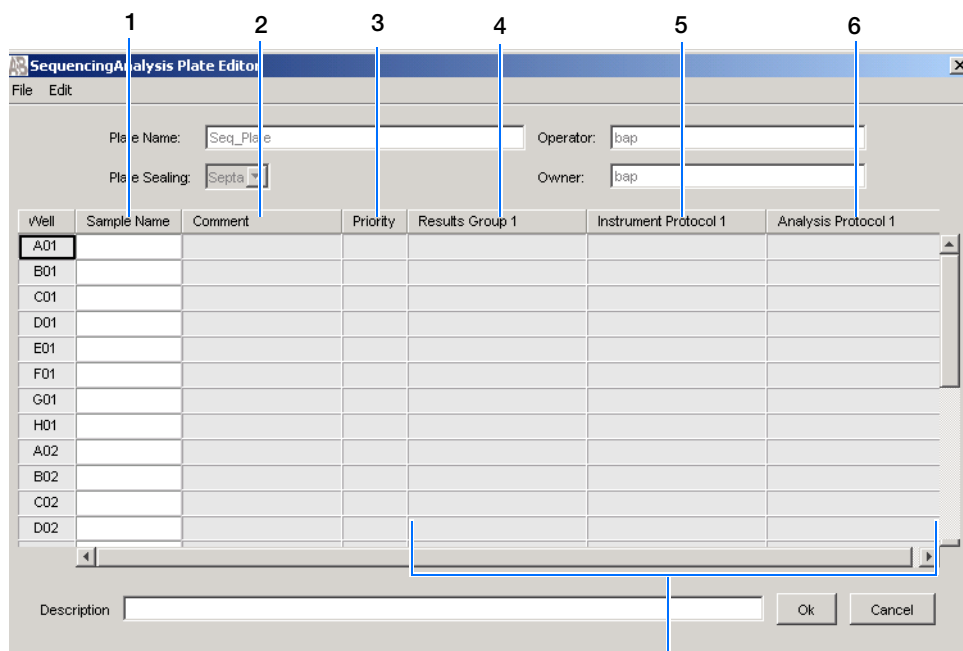

Default is one sample run, to add additional runs see [page 90](#)

Columns inserted in a plate record for a sequencing analysis run.

Number and Column	Description
1. Sample Name	Name of the sample
2. Comment	Comments about the sample (optional)
3. Priority	A default value of 100 to each sample. Changing the value to a smaller number increases the priority of that set of 16 or 4 samples to run before the others in the injection list.
4. Results Group	<p>Some options:</p> <ul style="list-style-type: none"> • New: Opens the Results Group Editor dialog box. • Edit: Opens the Results Group Editor dialog box for the Results Group listed in the cell. • None: Sets the cell to have no selected Results Group. • Select one of the available Results groups from the list. <p>Note: You must have a Results Group selected for each sample entered in the Sample Name column.</p> <p>See “Results Group for Sequencing Analysis” on page 81.</p>

Notes _____

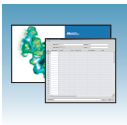

Chapter 4 Autoanalysis and Sequencing Analysis Software

About Plate Records and Sequencing Analysis

Number and Column	Description
5. Instrument Protocol	<ul style="list-style-type: none">• New: Opens the Protocol Editor dialog box.• Edit: Opens the Protocol Editor dialog box for the Instrument Protocol listed in the cell.• None: Sets the cell to have no selected protocol.• List of Instrument Protocols: In alpha-numeric order. <p>Note: You must have an Instrument Protocol selected for each sample entered in the Sample Name column.</p> <p>See “Instrument Protocol for Sequencing Analysis” on page 69.</p>
6. Analysis Protocol	<ul style="list-style-type: none">• New: Opens the Analysis Protocol Editor dialog box.• Edit: Opens the Analysis Protocol Editor dialog box for the Instrument Protocol listed in the cell.• None: Sets the cell to have no selected protocol.• List of Analysis Protocols: In alpha-numeric order. <p>Note: You must have an Analysis Protocol selected for each sample entered in the Sample Name column.</p> <p>See “Analysis Protocol for Sequencing Analysis” on page 72.</p>

Notes _____

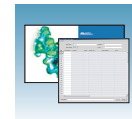

Creating Protocols for Automated Sequencing Analysis

If the appropriate instrument protocol, analysis protocol, and results group have been created, proceed to “Filling Out a Sequencing Analysis Plate Record” on page 88.

Instrument Protocol for Sequencing Analysis

An instrument protocol contains all the settings necessary to run the instrument: the protocol name, type of run, run module, and dye set.

WARNING Do not edit the instrument protocol currently being used, while the instrument is running.

Creating an Instrument Protocol

1. In the tree pane of the Data Collection software, click **GA Instruments** > **ga3130xl** or **ga3130** > **Protocol Manager**.

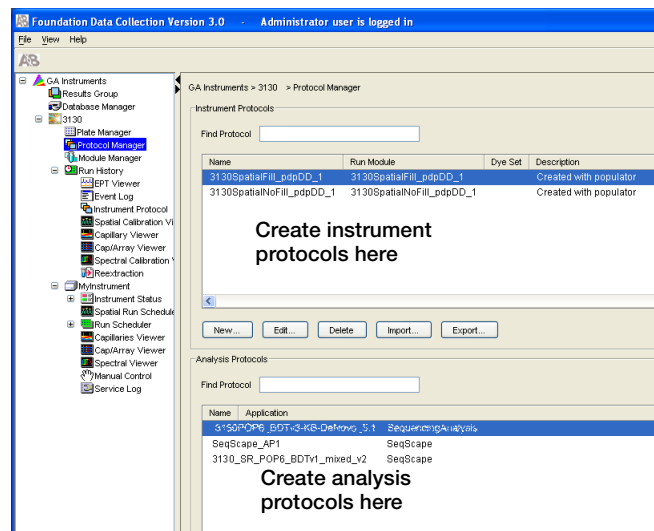

Notes

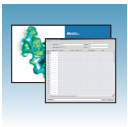

- In the Instrument Protocol section, click

New...

The Protocol Editor opens.

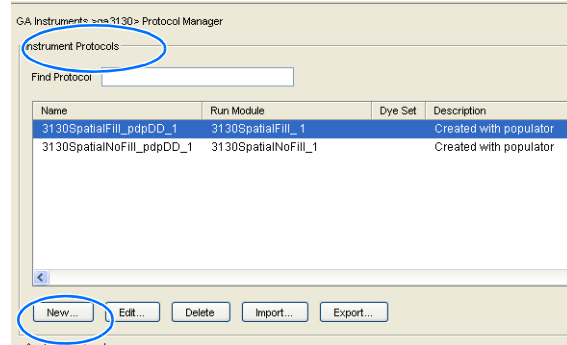

- Complete the Protocol Editor:

- Type a name for the protocol.
- Type a description for the protocol (optional).
- Select **Regular** in the Type drop-down list.

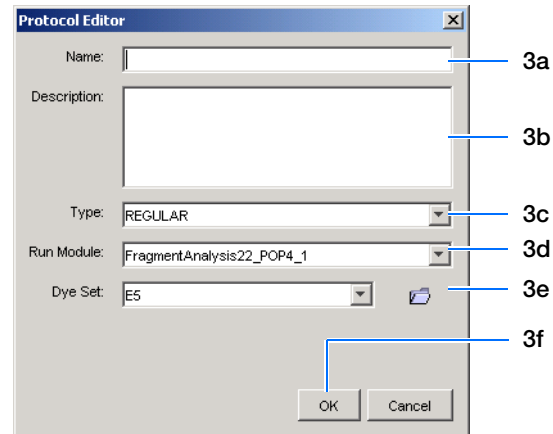

- Select the correct run module for your run. See [“Sequencing Resolution Performance and Specifications”](#) on page 11.

Note: To customize a run module, see the *Applied Biosystems 3130/3130xl Genetic Analyzers Maintenance, Troubleshooting, and Reference Guide* (Part no. 4477854).

Notes _____

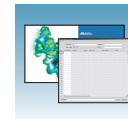

- e. Select the correct Dye Set for your run by using the table below.

Chemistry	Dye Set	POP-4 Polymer			POP-6 Polymer		POP-7 Polymer				
		UltraSeq36	StdSeq50	LongSeq80	RapidSeq36	StdSeq50	UltraSeq36	RapidSeq36	FastSeq50	StdSeq50	LongSeq80
BigDye® Terminator v3.1 Cycle Sequencing Kit	Z_BigDye V3	✓	✓	✓	✓	✓	✓	✓	✓	✓	✓
BigDye® Direct Cycle Sequencing Kit		–	–	–	–	–	✓	✓	✓	✓	–
dGTP BigDye® Terminator v3.0 Cycle Sequencing Ready Reaction Kit		–	–	–	–	–	–	–	–	–	–
BigDye® Terminator v1.1 Cycle Sequencing Kit	E_BigDye V1	✓	✓	✓	✓	✓	✓	✓	✓	✓	✓
dGTP BigDye® Terminator v1.0 Cycle Sequencing Ready Reaction Kit*		–	–	–	–	–	–	–	–	–	–
dRhodamine Dye Terminator Cycle Sequencing Kit		✓	✓	✓	✓	✓	–	–	–	–	–
BigDye® Primer Cycle Sequencing Kits		–	–	–	✓	✓	–	–	–	–	–

*dGTP kits are not supported on capillary electrophoresis instruments due to compressions on certain sequence context regions; you can run the kits if you are not concerned about compression issues. The dGTP BigDye Terminator Cycle Sequencing Kits replace dITP with dGTP to sequence GT- and G-rich templates.

- f. Click **OK**.

Importing an Instrument Protocol

1. Click **Import** in the Instrument Protocols pane of the Protocol Editor window to display the standard File Import dialog box.
2. Navigate to the location of the .xml file you want to import.
3. Select the .xml file and click **Open**.

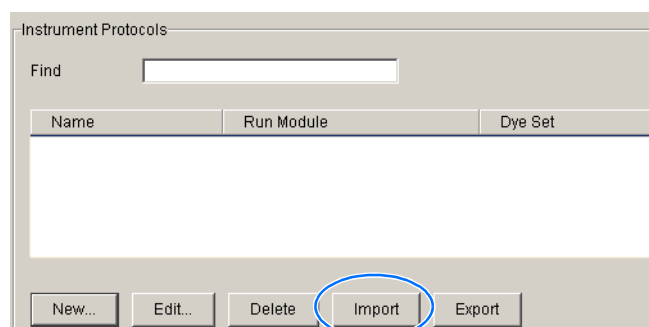

Exporting an Instrument Protocol

1. In the Instrument Protocols pane, highlight the protocol you want to export.
2. Click **Export** to display the standard File Export dialog box.
3. Browse to the desired folder location.

Notes

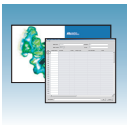

4. Click  .

Analysis Protocol for Sequencing Analysis

An analysis protocol contains all the settings necessary for analysis and post processing:

- **Protocol name** – The name, description of the analysis protocol, and the sequence file formats to be used.
- **Basecalling settings** – The basecaller, DyeSet/Primer file, and analysis stop point to be used.
- **Mixed Bases (Optional)** – When two bases are found at the same position. Define the percent value of the second highest to the highest peak.
- **Clear Range** – The high quality sequence remaining after trimming low quality sequences typically found at the beginning and ends of the sequence. The clear range can be based on base positions, sample quality values, and/or number of ambiguities (Ns) present.

Note: If you created an appropriate analysis protocol in the Sequencing Analysis software, you can use it in Data Collection software.

IMPORTANT! Do not delete an analysis protocol during a run while it is being used for that run. Autoanalysis will not be performed if you do so.

Notes _____

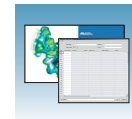

Creating an Analysis Protocol

See the *Applied Biosystems DNA Sequencing Analysis Software 6 User Guide* (Part no. 4474239) for more information on analysis protocols.

1. In the Analysis Protocol section of the Protocol Manager, click **New...**.

If more than one analysis application is installed on the data collection computer, the Analysis Applications dialog box opens.

Note: When you name your analysis protocol, assign a version name to help you distinguish your analysis protocols.

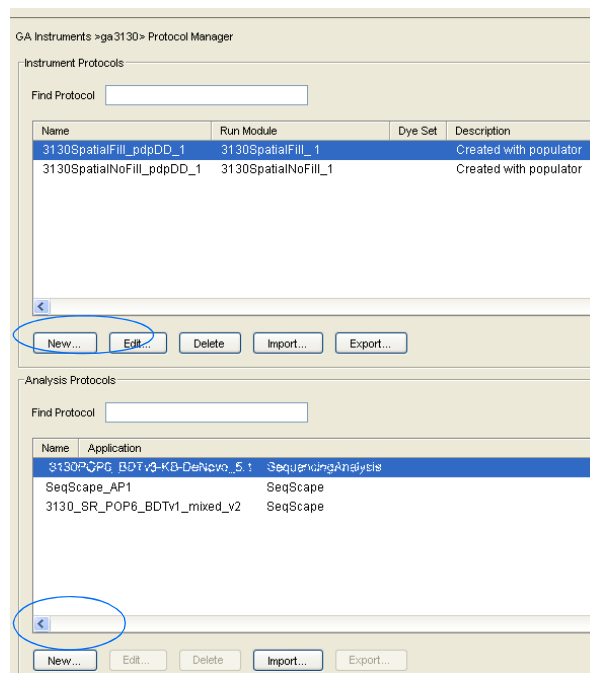

2. Select **Sequencing Analysis**, then click **OK** to open the Analysis Protocol Editor dialog box.

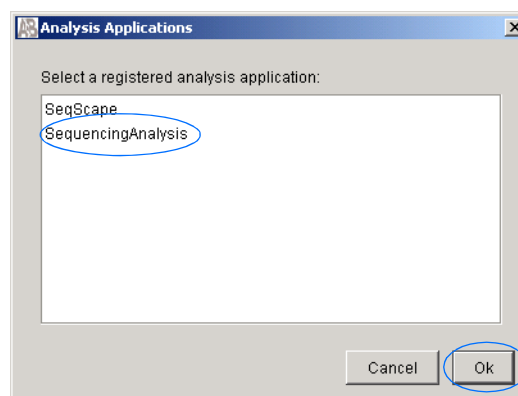

Notes _____

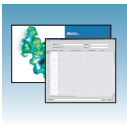

3. In the **General** tab:

- a. Enter a unique name and description for the new protocol.
- b. Select the appropriate Sequence File formats settings.

Option	Creates...
Write .Seq File check box	A .seq file for printing the sequence as text file or for use in other software. <ul style="list-style-type: none"> • Use ABI format with Applied Biosystems software. • Use FASTA format with other software.
Write Standard Chromatogram Format file (.scf)	A .scf file to use with other software. When created, the .scf extension is not appended to the file name.
Write Phred (.phd.1) File	A .phd.1 file to use with other software if you used the KB™ Basecaller.

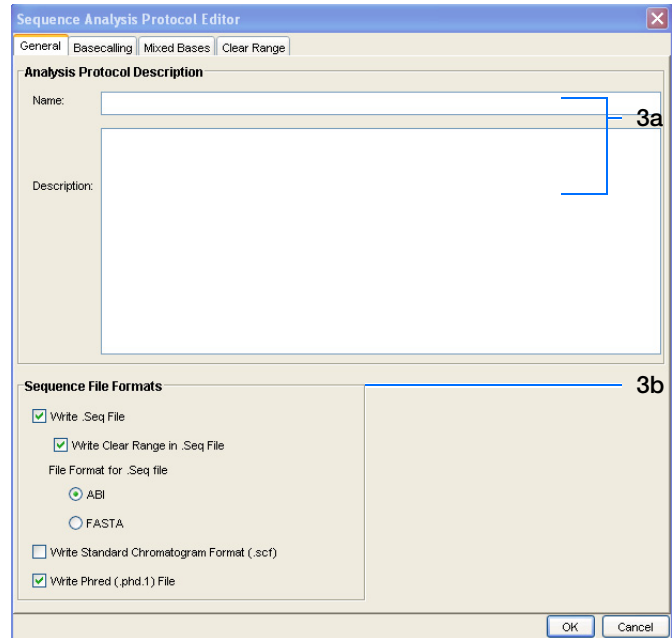

4. Select the **Basecalling** tab.

- a. See “3130/3130xl Genetic Analyzer Basecaller and DyeSet/Primer Files” on page 77 to select your basecaller and DyeSet primer file.

Note: Sequencing Analysis Software and 3130 Series Data Collection Software 4 filter .mob file choices to match the chosen .bcp file.

See Appendix B, “KB™ Basecaller Software v1.4.1,” for a comparison of Basecaller options. KB Basecaller can call 2-base mixed base positions (K, M, S, R, Y, and W) and assign per-base quality values, whereas the older ABI Basecaller cannot.

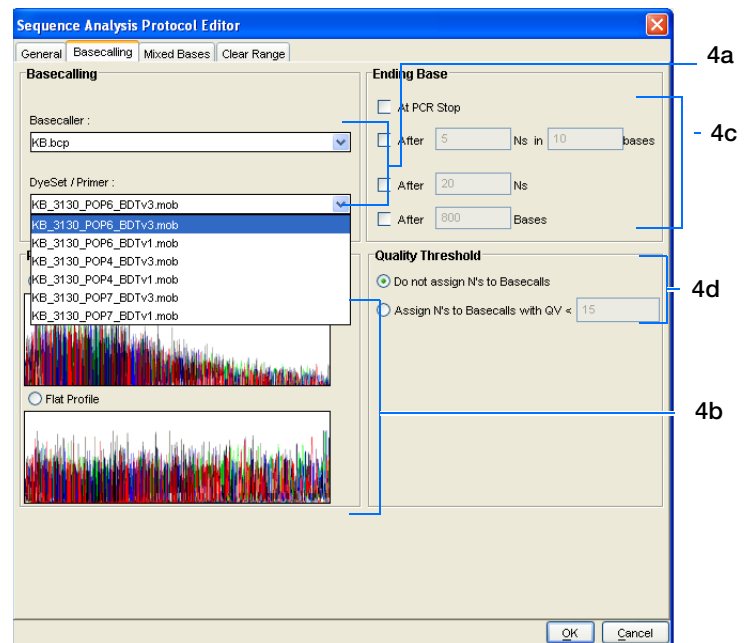

Notes _____



- b. In the Processed data pane, select True or Flat Profile.

Option	Used to display data as processed traces scaled...
<input checked="" type="radio"/> True Profile	Uniformly - the average height of peaks in the region of strongest signal is about equal to a fixed value. The profile of the processed traces will be very similar to that of the raw traces.
<input checked="" type="radio"/> Flat Profile	Semi-locally - the average height of peaks in any region is about equal to a fixed value. The profile of the processed traces will be flat on an intermediate scale (> about 40 bases). Note: This option is applied to data that is analyzed with the KB™ basecaller only. If you use the ABI basecaller, the profile option reverts to True Profile.

- c. If desired, select one or more stop points for data analysis.
- d. Select your Threshold Quality option. If data is expected to contain a PCR stop point within the electropherogram, check “At PCR Stop.”

Option	Function
<input checked="" type="radio"/> Call all bases and assign QV	With the KB™ Basecaller, use this setting to assign a base to every position, as well as the QV.
<input checked="" type="radio"/> Assign 'N' for bases with QV < <input type="text" value="15"/>	With the KB Basecaller, use this setting to assign Ns to base with QVs less than the set point. The QV is still displayed.

5. Select the **Mixed Bases** tab.

Note: This function is active with the KB Basecaller only.

Notes _____

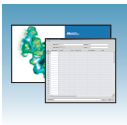

- a. For data containing any mixed bases, select **Use Mixed Base Identification**.
- b. The user can set the secondary peak threshold, as a percentage of the primary peak, for consideration as a mixed base by the basecalling algorithm.

Reaching this threshold is a necessary, but insufficient, condition for arriving at a mixed base determination. Set the percentage by entering a value into the “__%” field or by dragging the horizontal line above or below the 25% default setting (see figure at right).

Note: Do not use less than 15% as your detection limit.

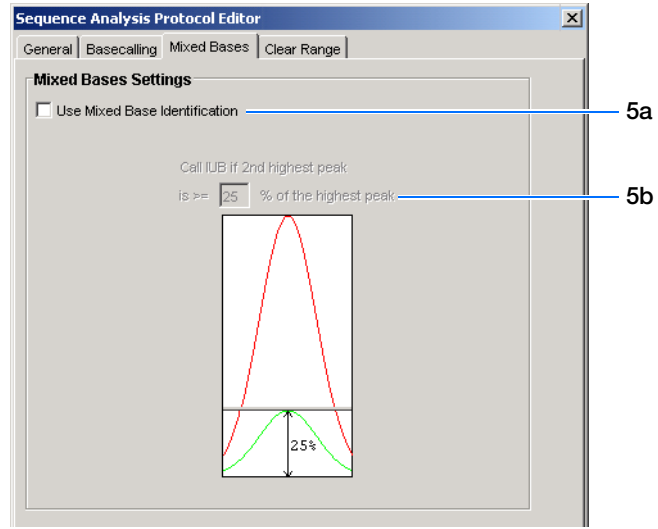

6. Select the Clear Range tab.

Note: The clear range is the region of sequence that remains after excluding the low-quality or error prone sequence at both the 5' and 3' ends.

Select one or more Clear Range methods. If you apply multiple methods, the smallest clear range results.

- 7. Click **OK** to save the protocol and close the Sequence Analysis Protocol Editor dialog box.

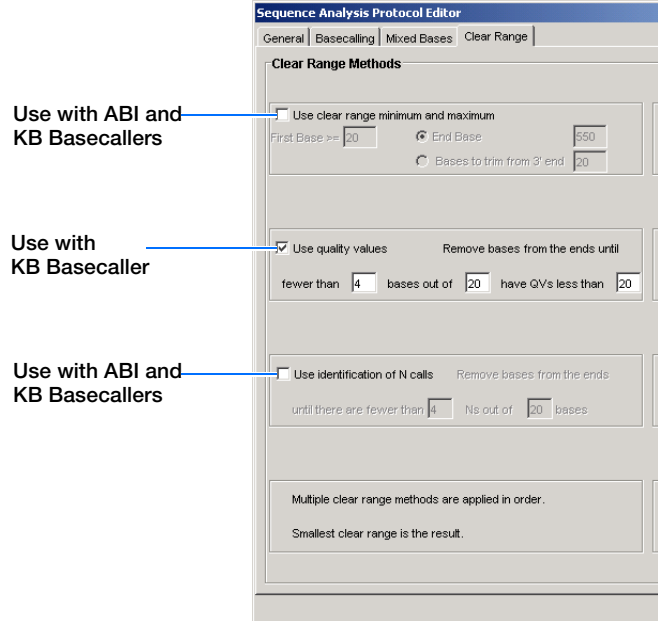

Notes _____

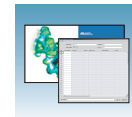

3130/3130xl Genetic Analyzer Basecaller and DyeSet/Primer Files

Basecaller and DyeSet/Primer Files Used with BigDye® Terminator Chemistry and KB Basecalling

DNA Sequencing Chemistry	Polymer	KB Basecalling Run Module	DyeSet/Primer	Basecaller	
BigDye® Terminator v1.1 Cycle Sequencing Kit	POP-4®	UltraSeq36_POP4	KB_3130_POP4_BDTv1.mob	KB.bcp	
		StdSeq50_POP4			
		LongSeq80_POP4			
	POP-6™	RapidSeq36_POP6	KB_3130_POP6_BDTv1.mob		
		StdSeq50_POP6			
	POP-7™	UltraSeq36_POP7	KB_3130_POP7_BDTv1.mob		
		RapidSeq36_POP7			
		FastSeq50_POP7			
		StdSeq50_POP7			
		LongSeq80_POP7			
	BigDye® Terminator v3.1 Cycle Sequencing Kit	POP-4®	UltraSeq36_POP4		KB_3130_POP4_BDTv3_.mob
			StdSeq50_POP4		
LongSeq80_POP4					
POP-6™		RapidSeq36_POP6	KB_3130_POP6_BDTv3.mob		
		StdSeq50_POP6			
POP-7™		UltraSeq36_POP7	KB_3130_POP7_BDTv3.mob		
		RapidSeq36_POP7			
		FastSeq50_POP7			
		StdSeq50_POP7			
		LongSeq80_POP7			
BigDye® Direct Cycle Sequencing Kit		POP-7™	UltraSeq36_POP7	KB_3130_POP7_BDTv3direct.mob	
			RapidSeq36_POP7		
	FastSeq50_POP7				
	StdSeq50_POP7				

4

Notes _____

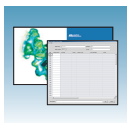

Basecaller and DyeSet/Primer Files Used with BigDye® Terminator Chemistry and ABI Basecalling

DNA Sequencing Chemistry	Polymer	ABI Basecalling Run Module	Basecaller	DyeSet/Primer
BigDye® Terminator v1.1 Kit	POP-4®	UltraSeq36_POP4	Basecaller-3130POP4UR.bcp	DT3130POP4LR{BD}v1.mob
		LongSeq80_POP4	Basecaller-3130POP4_80cmv3.bcp	
	POP-6™	RapidSeq36_POP6	Basecaller-3130POP6RRv2.bcp	DT3130POP6{BD}v2.mob
		StdSeq50_POP6	Basecaller-3130POP6SR.bcp	
BigDye Terminator v3.1 Cycle Sequencing Kit	POP-4®	UltraSeq36_POP4	Basecaller-3130POP4UR.bcp	DT3130POP4{BDv3}v1.mob
		LongSeq80_POP4	Basecaller-3130POP4_80cmv3.bcp	
	POP-6™	RapidSeq36_POP6	Basecaller-3130POP6RRv2.bcp	DT3130POP6{BDv3}v1.mob
		StdSeq50_POP6	Basecaller-3130POP6SRv2.bcp	
dRhodamine Dye Terminator Cycle Sequencing Kit	POP-4®	UltraSeq36_POP4	Basecaller-3130APOP4UR.bcp	DT3130POP4{dRhod}v2.mob
		LongSeq80_POP4	Basecaller-3130POP4_80cmv3.bcp	
	POP-6™	RapidSeq36_POP6	Basecaller-3130POP6RRv2.bcp	DT3130POP6{dRhod}v2.mob
		StdSeq50_POP6	Basecaller-3130POP6SR.bcp	

Dye Primer Chemistry

Basecaller and DyeSet/Primer Files Used for Dye Primer Chemistry

DNA Sequencing Chemistry	Polymer	ABI Basecalling Run Module	Basecaller	DyeSet/Primer
BigDye® Primer Cycle Sequencing Kit	POP-6™	RapidSeq36_POP6	Basecaller-3130POP6RRv2.bcp	DP3130POP6{BD-21M13}v1.mob
		StdSeq50_POP6	Basecaller-3130POP6SR.bcp	DP3130POP6{BD-21M13Rev}v1.mob

Notes _____

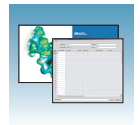

Editing and Deleting Analysis Protocols

Editing an Analysis Protocol

1. In the Analysis Protocols pane in the Analysis Protocol Manager, highlight the protocol you want to edit.
2. Click **Edit...**.
3. Make changes in the General, Basecalling, Mixed Bases and Clear Range tabs, if appropriate.
4. Click **OK** to save the protocol and close the Analysis Protocol Editor dialog box.

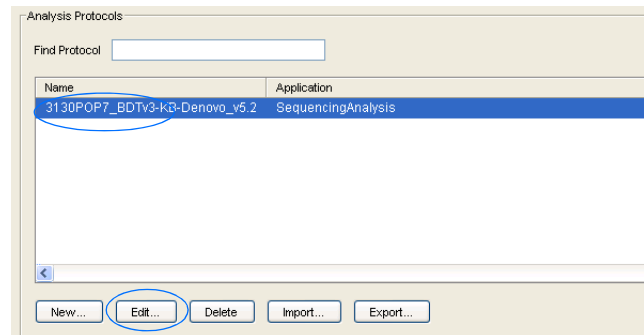

Deleting an Analysis Protocol

IMPORTANT! Do not delete an analysis protocol during a run while it is being used for that run. Autoanalysis will not be performed if you do so. You must first delete any plate records using the analysis protocol before you can delete or modify the analysis protocol for these plate records.

1. In the Analysis Protocols pane in the Analysis Protocol Manager, highlight the protocol you want to delete.
2. Click **Delete** to display the Deletion Confirmation dialog box.
3. Click **Yes**.

Note: To reuse a plate after deleting the associated analysis protocol, recreate the analysis protocol with the same name or assign the plate a unique name.

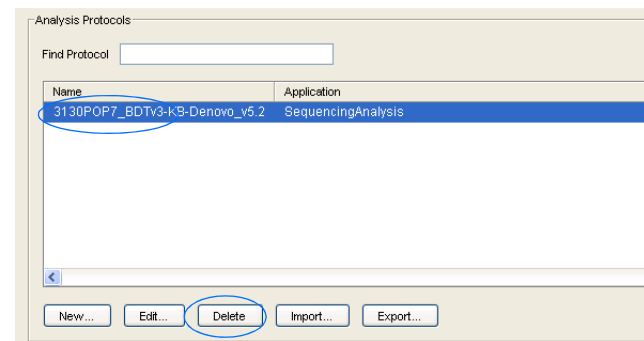

Notes

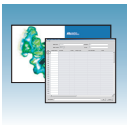

Exporting an Analysis Protocol

1. In the Analysis Protocols pane in the Analysis Protocol Manager, highlight the protocol you want to export.
2. Click **Export** to display the standard File Export dialog box.
3. Browse to the desired folder location.
4. Click **Save**.

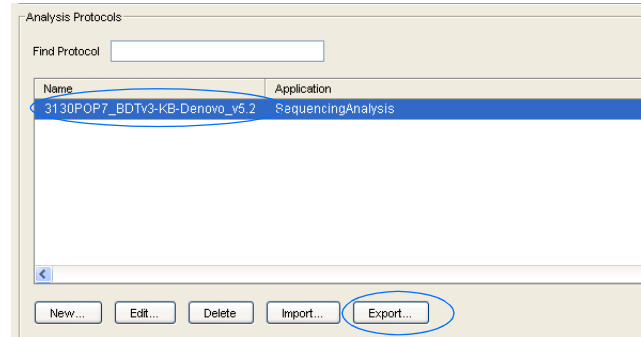

Importing an Analysis Protocol

1. Click **Import** to display the standard File Import dialog box.
2. Browse for the .xml file to import and click **Open**.

Note: For multiple applications, select the appropriate application to associate with the analysis protocol.

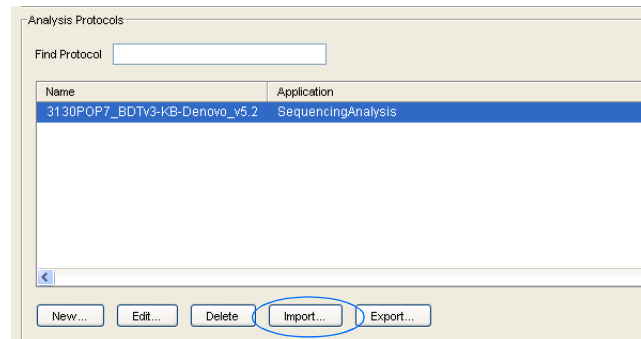

Notes _____



Results Group for Sequencing Analysis

A Results Group is a component within Data Collection that organizes samples and certain user settings under a single name. It is called a Results Group because it is used to name, sort, and deliver samples that result from a run.

Creating a Results Group

1. In the tree pane of the Data Collection software, click **GA Instruments** > **Results Group**.
2. Click **New...** to display the Results Group Editor window.

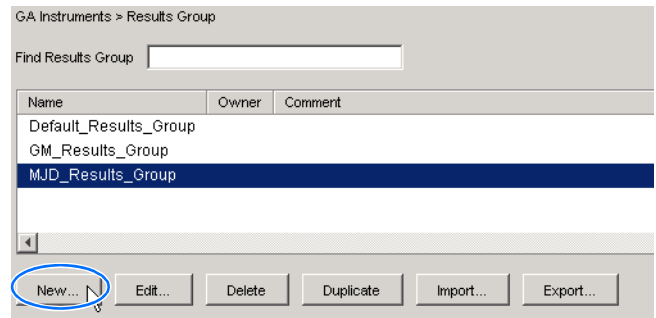

3. Complete the General tab:
 - a. Type a unique Results Group Name. The name can be used in grouping sample files.
 - b. Type a Results Group Owner (optional). The owner name can be used in naming and sorting sample files.
 - c. Type a Results Group Comment (optional).

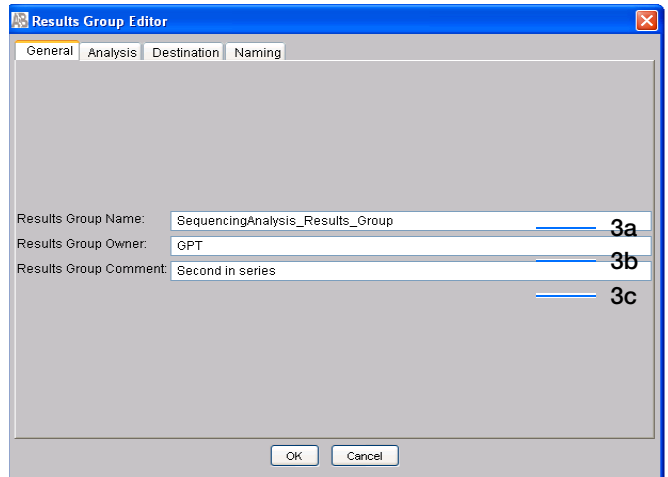

Notes _____

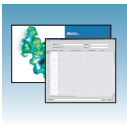

4. Select the Analysis tab, then:

- a. Select **Sequencing Analysis** from the Analysis Type drop-down list.
- b. In the Analysis Actions section, select **Do Autoanalysis**, if you want your data automatically analyzed after a run.

Note: Login ID and password are not required for Sequencing Analysis software.

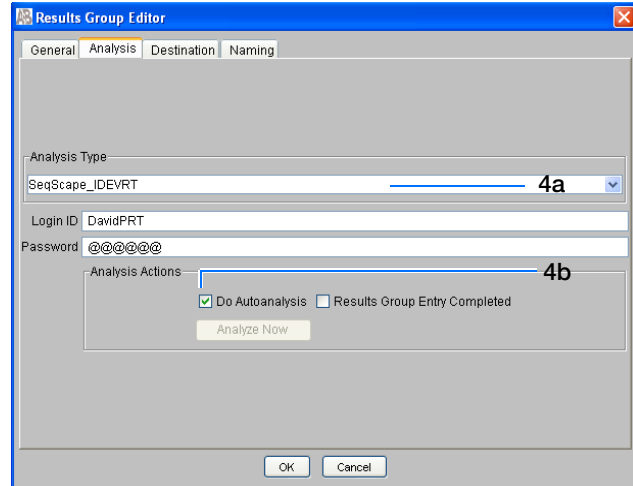

5. Select the Destination tab, then use the default destination or define a new location for data storage.

To use ...	Then ...
default location; see next page for information on *Sample File Destinations	skip to step 6.
custom location	complete steps a-b.

Note: The Results Group Destination tab, and Data Collection software in general, does not recognize remote storage locations unless they have been mapped to a local drive letter using the Map Network Drive feature of the operating system. Specify the mapped drive letter location in the Results Group Destination tab.

- a. Click **Use Custom Location**, then click **Browse...** to navigate to a different save location.
- b. Click **Test** to test the Location path name connection:

If it...	Then a message box displays ...
Passes	Test succeeded: <"path">.

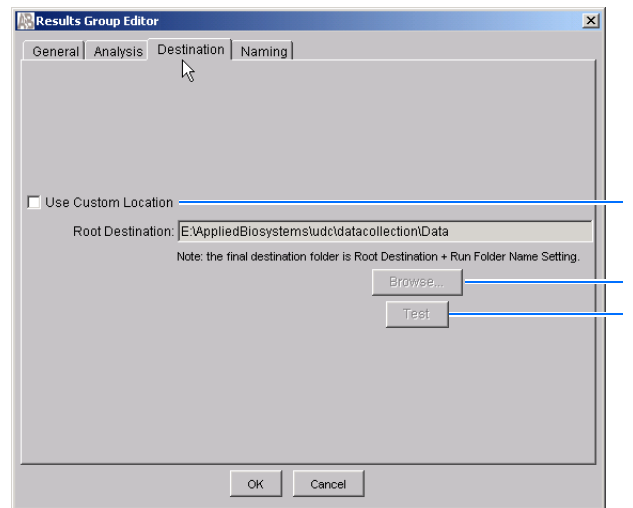

Notes



If it...	Then a message box displays ...
Fails	Test failed:<"path">.

***Sample File Destinations**

Locations where sample files are placed during extraction:

- Default Destination, default folder naming: E:\AppliedBiosystemsUDC\DataCollection\data\<instrument type>\<instrument name>\run folder
- Default Destination, custom folder naming: E:\AppliedBiosystemsUDC\DataCollection\data\top custom folder\subfolders, etc.
- Custom Destination, default folder naming: Destination\<instrument type>\<instrument name>\run folder
- Custom Destination, custom folder naming: Destination\top customer folder\subfolders, etc.

6. Select the Naming tab.

Use the Naming tab to customize sample file and run folder names. You have two options:

- Use the default names for the folder and sample file.
- Use custom names for the folder and sample file. See [“Optional: Completing Sample File Name Format Pane”](#) on page 84 for elements of the Naming tab.

Note: Sample name, run folder name, and path name, *combined*, can total no more than 250 characters.

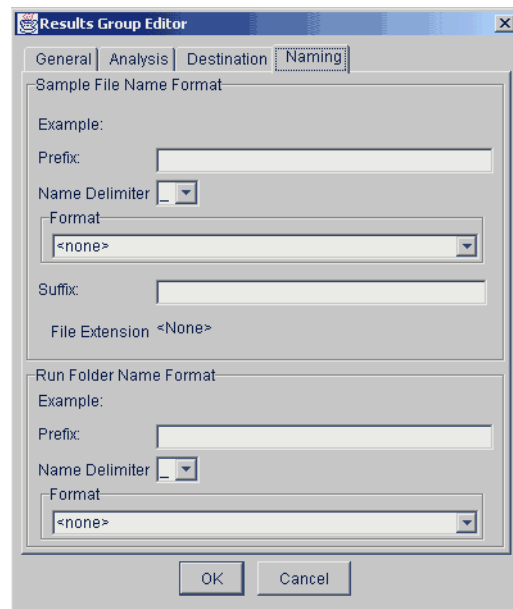

Sample File Name Format pane

Run Folder Name Format pane

Notes

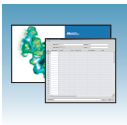

Optional: Completing Sample File Name Format Pane

Note: The default sample file naming for sequencing analysis is:

seq_<capillary number>_<wellposition>.ab1

1. Select the **Naming** tab.

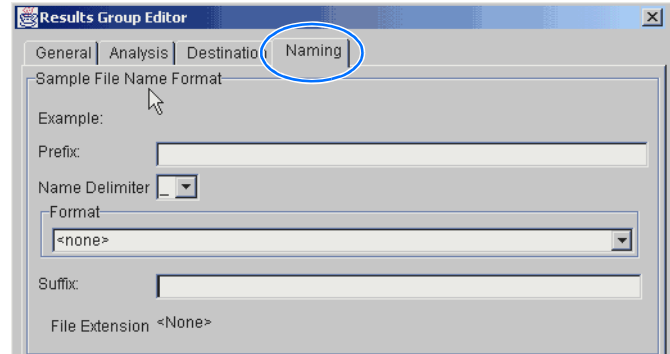

2. Type a prefix for the file name in the Prefix box. Your entry is shown in the Example line.

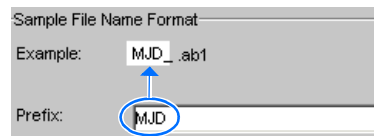

3. Select the symbol that separates the Format elements in the file name from the **Name Delimiter** drop-down list. Only one delimiter symbol may be chosen.

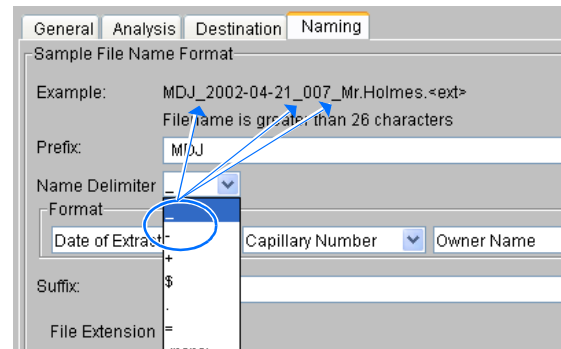

4. Click the Format list and then select the components that you want in the sample name.

Note: All the samples from a single run can be placed in the same run or results folder, so the name of every sample from a single run should be different. Most of the Format options are not different between samples, so select at least one of the options that make the sample names unique within a run.

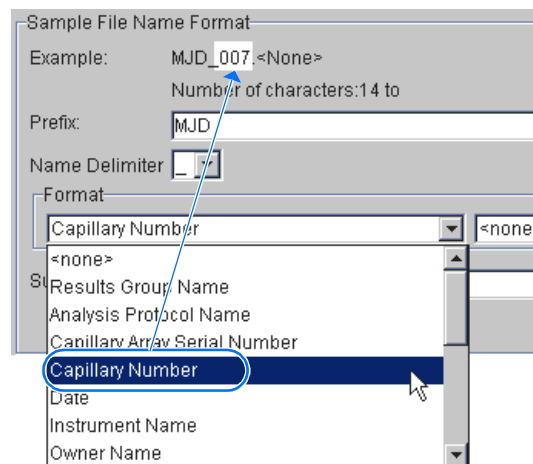

Notes

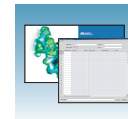

If a unique identifier is not included in the name, a warning message displays. Select from the elements to make a unique sample file name.

Examples are:

- Well position
- Capillary number
- Run sequence number
- Plate Quadrant

Note: some identifiers, such as well position, capillary number and plate quadrant are not unique in multiple sample instances. Plate Quadrant is not a unique identifier for a 96-well plate.

As you select the elements for the file name, they are placed in the Example line. An additional element drop-down menu displays allowing you the option of selecting an additional element.

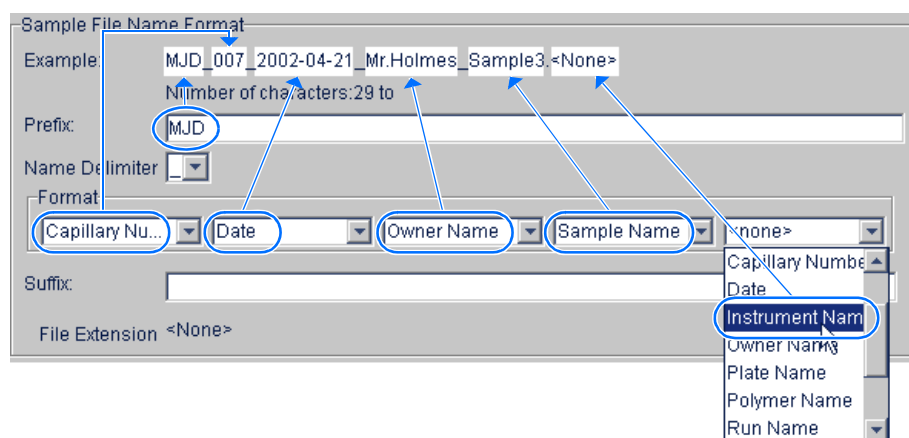
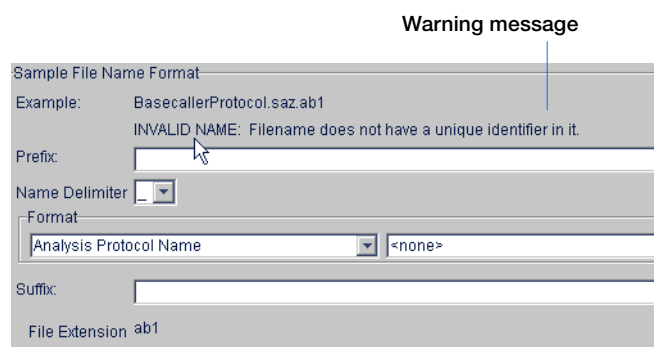

The names of the Format elements eventually truncate, but the Example field remains visible (up to 72 characters).

Note: Resize the Results Group window horizontally to view the element options.

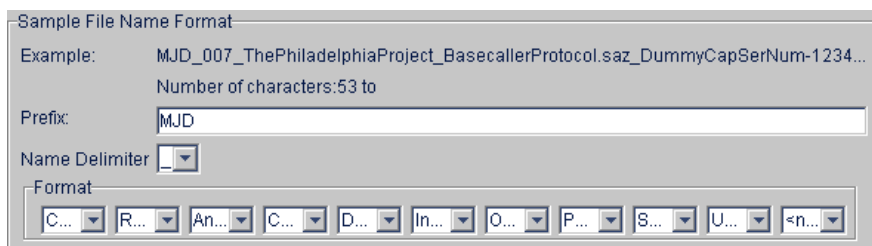

Notes

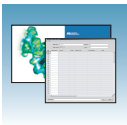

5. Type the suffix for the file name in the Suffix box.

Note: The File Extension field displays the file extension generated from the Analysis Type specified on the Analysis tab (see [page 82](#)). For example, Sequencing Analysis produces sample files with a .ab1 extension.

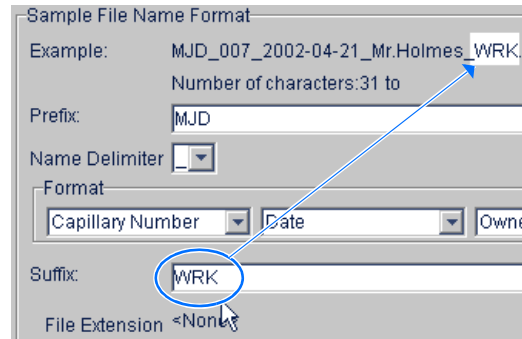

Optional: Run Folder/Sub-Folder Name Format Pane

Note: The default run folder naming for sequencing analysis is Run_<Instrumentname>_<Dateand TimeofRun>_<RunSeq#>.

Follow the same steps described for the Sample File Name Format pane (see [page 84](#)) to change the sub-folder name within the run folder. Make the sub-folder name unique, such as using the Run Folder name.

Saving a Results Group

Click **OK** from any tab once all the elements within the Results Group have been chosen.

Note: Even if you create a custom run folder location, the system generates a separate default run folder that contains the log file.

Importing and Exporting a Results Group

Results Groups can be imported from, or exported to, XML files allowing sharing of identical Results Groups between instruments.

Importing a Results Group

1. In the tree pane of the Data Collection software, click **GA Instruments > Results Group**.
2. Click **Import** to display the standard File Import dialog box.

Notes

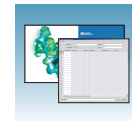

3. Navigate to the file you want to import.

Note: Import file type is .xml (XML file).

4. Click **Open** .

Exporting a Results Group

1. In the tree pane of the Data Collection software, click **GA Instruments > Results Group**.

2. Click the Results Group name to select it.

3. Click **Export** .

A standard file export dialog box displays with the chosen Results Group name.

4. Navigate to the location where you want to save the exported file.

5. Click **Save** .

Note: If there is a name conflict with a Results Group that already exists at the save location, then duplicate the Results group. Duplication copies the settings into a similar Results Group without the risk of user error when copying it manually (see procedure below).

Duplicating a Results Group

1. Click the Results Group name.

2. Click **Duplicate** .

Note: When you duplicate a Results Group, you are asked to type a name for the new Results Group and for the analysis application type.

Notes _____

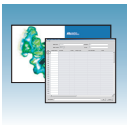

Filling Out a Sequencing Analysis Plate Record

Creating a Sequencing Analysis Plate Record

1. In the tree pane of the Data Collection software, click **GA Instruments** > **ga3130xl** or **ga3130** > **Plate Manager**.
2. Click **New...** to display the New Plate Dialog dialog box.
3. Complete the information in the New Plate Dialog:
 - a. Type a name for the plate.
 - b. Type a description for the plate (optional).
 - c. Select your sequencing application in the Application drop-down list.
 - d. Select **96-well** or **384-well** in the Plate Type drop-down list.
 - e. Type a name for the owner and operator.
- f. Click **OK** to open the Sequencing Analysis Plate Editor.

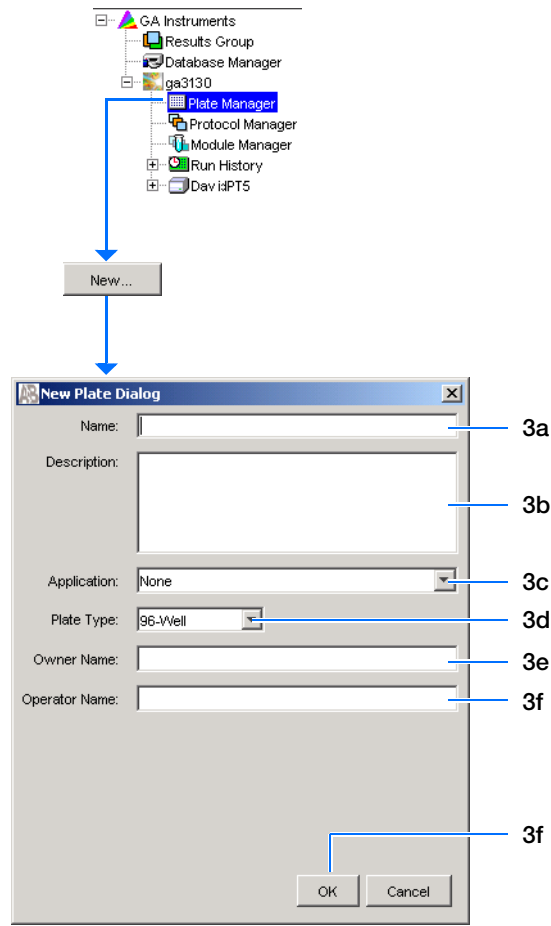

Notes _____



Completing a Sequencing Analysis Plate Record

1. In the **Sample Name** column of a row, enter a sample name, then click the next cell. The value 100 automatically displays in the Priority column.
2. In the **Comments** column, enter any comments or notations for the sample.
3. In the **Priority** column, you can change the priority value. A lower number for each 4 or 16 set, receives a higher run priority.
4. In the **Results Group 1** column, select a group from the drop-down list (see [page 81](#)) or create a new Results Group.
5. In the **Instrument Protocol 1** column, select a protocol from the drop-down list (see [page 69](#)) or create a new instrument protocol.
6. In the **Analysis Protocol 1** column, select a protocol from the drop-down list (see [page 73](#)) or create a new analysis protocol.
7. Complete the plate record based on the samples loaded in your plate:
 - For the single runs that use the same samples and protocols – Highlight the entire row, then select **Edit > Fill Down Special**. Based on your plate type (96- or 384-well) and capillary array (16 or 4 capillaries), the software automatically fills in the appropriate well numbers for a single run or
 - For entire plates that use the same samples and protocols – Highlight the entire row, then select **Edit > Fill Down** to fill down the entire plate editor.
 - For plates with different samples and protocols – complete the entries manually.

Well	Sample Name	Comment	Priority	Results Group 1
A01				
B01				
C01				
D01				
E01				
F01				

Instrument Protocol 1	Analysis Protocol 1

Edit	
Fill Down	Ctrl+D
Copy	Ctrl+C
Paste	Ctrl+V
Clear row(s)	Shift+Delete
Fill Down Special	Alt+D
Add Sample Run	Alt+A

Notes

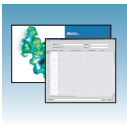

- To do more than one injection of the same sample, select **Edit > Add Sample Run**.

Results Group, Instrument Protocol and Analysis Protocol columns are added to the right end of the plate record.

- Complete the columns for the additional runs.

- Click .

Note: After clicking OK in the Plate Editor, the completed plate record is stored in the Plate Manager database. The plate record can be searched for, edited, duplicated, exported, or deleted in the Plate Manager.

Note: If multiple cells are selected for copying, select the same number of corresponding target cells before you execute the Paste command.

Note: The Plate Editor Copy and Paste functionality is supported only within one plate editor. To copy and paste the contents of one plate to another plate, use the Duplicate ... button on the Plate Manager dialog box.

Note: All plate information must be valid to use the duplicate plate function. If information is not valid, an empty plate will result.

Note: When you add another sample run to a processed plate, confirm that all the information in the processed runs is valid. Otherwise, that data will not be validated, and a new sample run cannot be created.

Edit	
Fill Down	Ctrl+D
Copy	Ctrl+C
Paste	Ctrl+V
Clear row(s)	Shift+Delete
Fill Down Special	Alt+D
Add Sample Run	Alt+A

Notes _____

Fragment Analysis with GeneMapper® Software

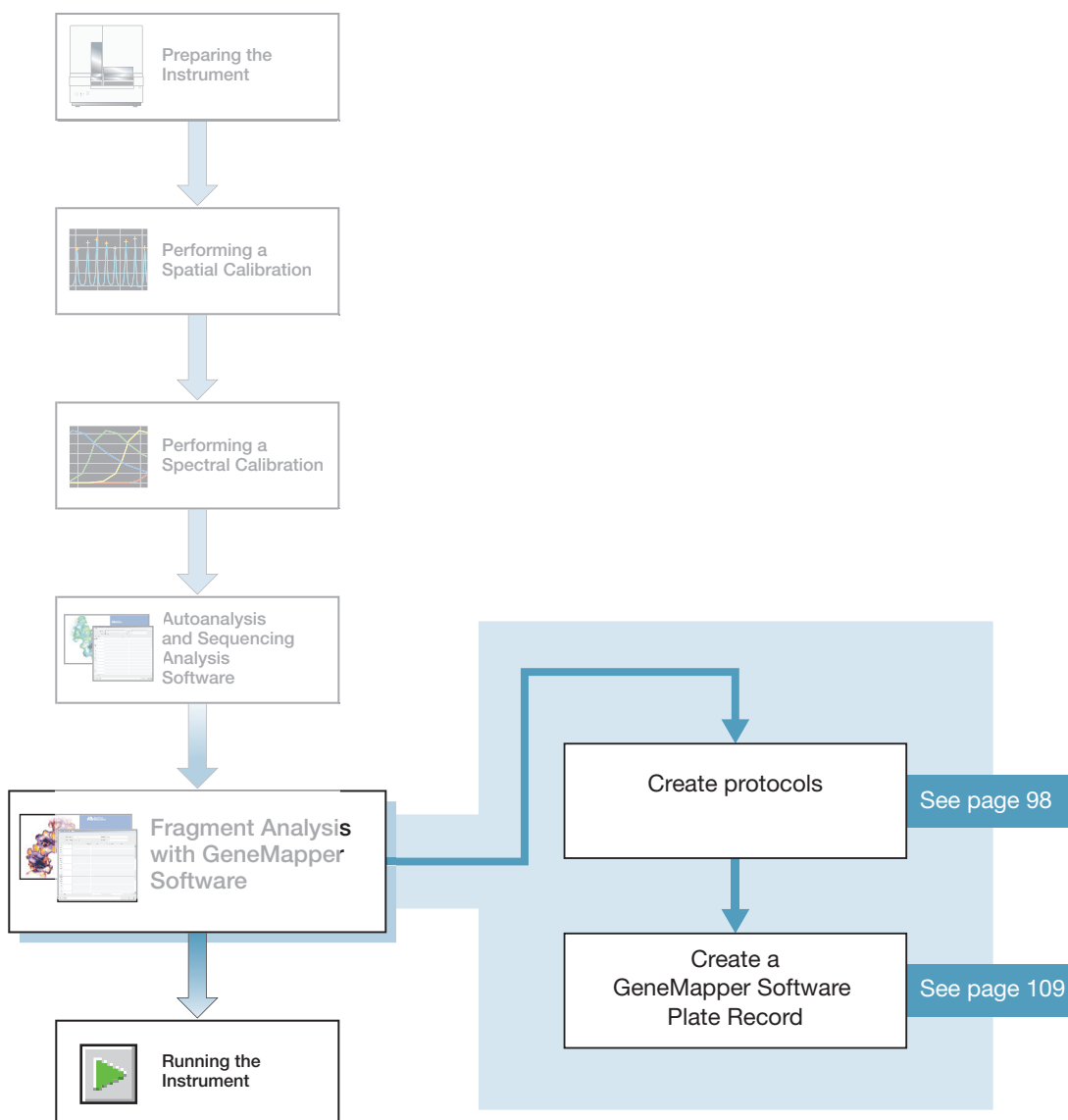
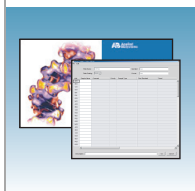

Notes



GeneMapper® Software

Analyze your fragment analysis samples using GeneMapper® Software 5. There is limited support for analysis with older versions of GeneMapper Software. Autoanalysis with GeneMapper Software is no longer supported.

Note: This chapter is written for both GeneMapper® Software 5 or higher and GeneMapper® *ID-X* Software v1.3. Graphic examples are from GeneMapper Software v3.7.

GeneMapper® Software 5 and GeneMapper *ID-X* Software v1.3

Perform analysis of fragment analysis samples with features of the 3130 Series Data Collection Software 4 and GeneMapper software using the same instrument computer that collected the sample files or on a remote computer.

- Autoanalysis is no longer supported.
- If you want to edit/review analysis results on another computer, transfer the GeneMapper software project, analysis methods, size standards, panel, and bin set information to the other GeneMapper software database. All components need to be exported and imported individually.
- When completing the plate record, fill in the instrument protocol and other information for Data Collection software to complete the run.
- Limited support for older versions of GeneMapper and GeneMapper *ID-X* software

File-Naming Convention

Some alphanumeric characters are not valid for user names or file names. Do not use the invalid characters below:

spaces

\ / : * ? " < > |

IMPORTANT! An error message is displayed if you use any of these characters. You must remove the invalid character to continue.

Manual Analysis

For information on manual analysis, see the *GeneMapper Software 5 User Guide* or *GeneMapper ID-X Software v1.3 User Guide*.

Notes _____

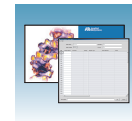

About Fragment Analysis and Data Collection

When GeneMapper software is installed on a computer that has 3130 Series Data Collection Software 4, two applications are available through the Results Group Editor (see [page 102](#)):

- GeneMapper-Generic
- GeneMapper-<Computer Name>

GeneMapper-Generic

Use GeneMapper-Generic to generate .fsa files. When completing the Sample Sheet, fill in basic information for the Data Collection software to complete the run; all other GeneMapper software related fields are text entries. Text entries are useful if you are using other software analysis applications or choose to analyze your samples in GeneMapper software on another computer, but do not have the same entries in the GeneMapper software database stored on the Data Collection computer. For example, if you have a customized size standard definition on another GeneMapper software computer, you can type in that size standard name in the size standard text field and it will populate that column in your GeneMapper software project.

GeneMapper-<Computer Name>

GeneMapper-<Computer Name> permits the Size Standard, Analysis Method, and Panel columns in the Sample Sheet window to be read directly from the GeneMapper software database. Create these components in GeneMapper software prior to setting up the plate record for a run. New entries cannot be created for these columns once you are in the plate editor dialog box. If you create a new GeneMapper software component while the plate record dialog box is open, the columns will not update. The plate record must be closed and reopened to update the GeneMapper software components. For more information see, “[Creating Protocols for Fragment Analysis](#)” on [page 98](#).

Notes _____



About GeneMapper Software Plate Records

A plate record is similar to a sample sheet or an injection list that you may have used with other Applied Biosystems instruments.

Plate records are data tables in the instrument database that store information about the plates and the samples such as:

- Plate name, type, and owner
- Position of the sample on the plate (well number)
- Comments about the plate and about individual samples
- Dye set information (in Instrument protocol)
- Name of the run module where run modules specify information about how samples are run (in Instrument protocol)

When to Create a Plate Record

Create a plate record for each plate of samples for the following types of runs:

- Spectral calibrations
- Sequencing Analysis Software
- GeneMapper® Software
- Mixed (sequencing and fragment analysis samples – see the *Applied Biosystems 3130/3130xl Genetic Analyzers Maintenance, Troubleshooting, and Reference Guide*, Part no. 4477854, for creating a mixed plate record)

To begin a run, you must create a plate record and link it to a plate loaded on the instrument. However, you can create plate records for new plates while a run is in progress.

Files needed to create a GeneMapper software plate record:

Parameters	Description	See Page
Instrument Protocol	Contains everything needed to run the instrument.	98
Results Group	Defines the file type, the file name, autoanalysis, and file save locations that are linked to sample injections.	102

IMPORTANT! For successful data collection and analysis, each sample run must have an Instrument Protocol, a Results Group, and files created in GeneMapper software assigned within a plate record.

Note: Autoanalysis with GeneMapper Software is no longer supported.

Notes _____



Elements of a GeneMapper software plate record

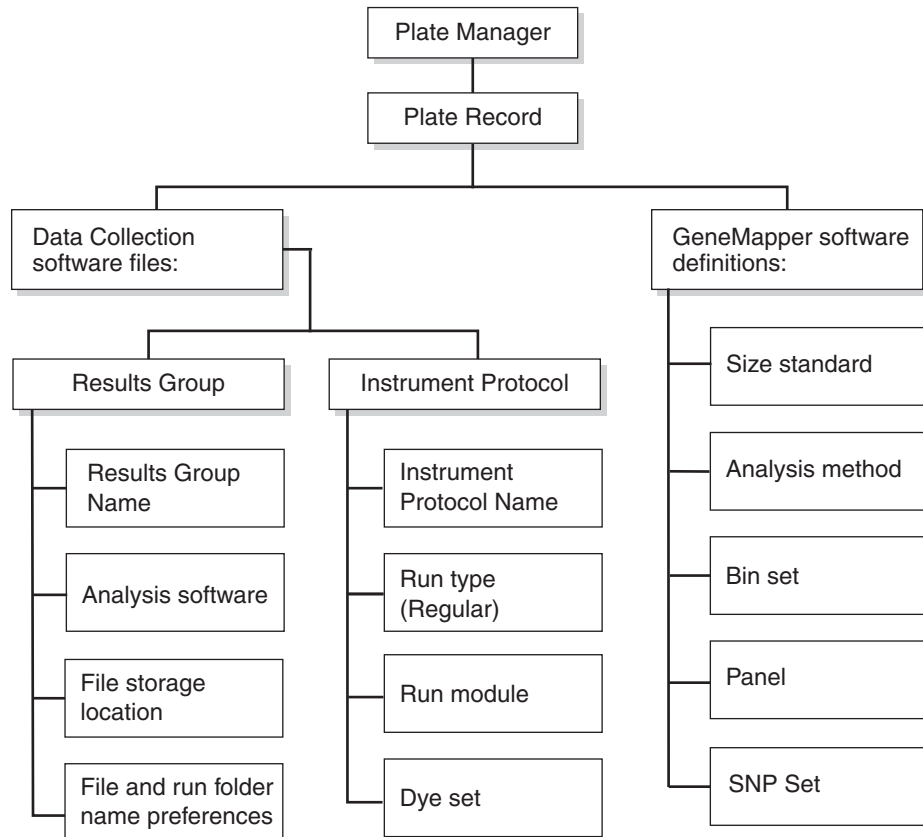

Notes _____



Chapter 5 Fragment Analysis with GeneMapper® Software

About GeneMapper Software Plate Records

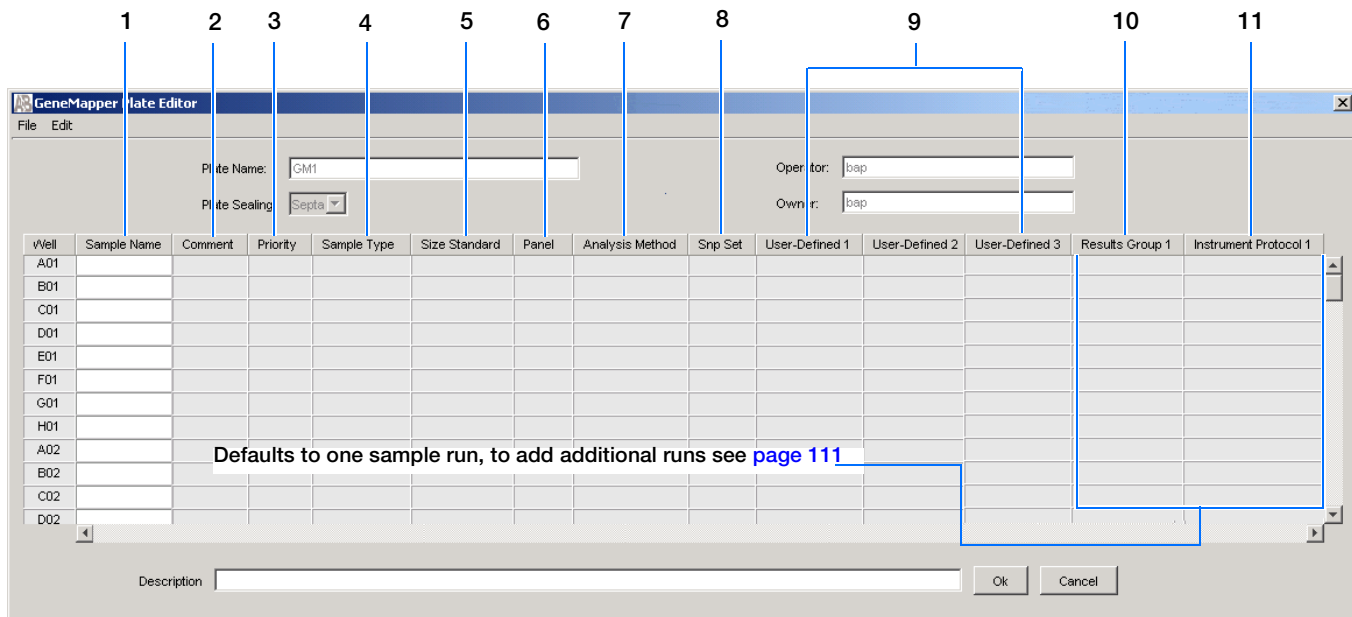

Blank GeneMapper software plate record

Columns inserted in a plate record for a fragment analysis run

Number and Column	Description
1. Sample Name	Name of the sample
2. Comment	Comments about the sample (optional)
3. Priority	A default value of 100 to each sample. Changing the value to a smaller number causes that set of 16 or 4 samples to run before the others in the injection list.
4. Sample Type	Use to identify the sample as Sample, Positive Control, Allelic Ladder or Negative Control.
5. Size Standard IMPORTANT! For GeneMapper-<Computer Name> ONLY: Create the Size Standard, Panel, and Analysis Method in GeneMapper software before creating a new plate to make them available in Data Collection software.	<ul style="list-style-type: none"> GeneMapper-Generic (optional): Manually enter size standards in the text field GeneMapper-<Computer Name>: Select a saved size standard from the drop-down list
6. Panel IMPORTANT! For GeneMapper-<Computer Name> ONLY: Create the Size Standard, Panel, and Analysis Method in GeneMapper software before creating a new plate.	<ul style="list-style-type: none"> GeneMapper-Generic (optional): Manually enter panels in the text field GeneMapper-<Computer Name>: Select a saved panel from the drop-down list

Notes



Number and Column	Description
7. Analysis Method IMPORTANT! For GeneMapper <Computer Name> ONLY: Create the Size Standard, Panel, and Analysis Method in GeneMapper software before creating a new plate.	<ul style="list-style-type: none"> GeneMapper-Generic (optional): Manually enter analysis methods in the text field. GeneMapper-<Computer Name>: Select a saved analysis method from the drop-down list.
8. SNP Set	Optional
9. Three User-defined columns	Optional text entries
10. Results Group	Options: <ul style="list-style-type: none"> New: Opens the Results Group Editor dialog box. Edit: Opens the Results Group Editor dialog box for the Results Group listed in the cell. None: Sets the cell to have no selected Results Group. Select one of the available Results groups from the list. <p>Note: You must select a Results Group for each sample entered in the Sample Name column. See “Results Group for Fragment Analysis” on page 101.</p>
11. Instrument Protocol	Options: <ul style="list-style-type: none"> New: Opens the Protocol Editor dialog box. Edit: Opens the Protocol Editor dialog box for the Instrument Protocol listed in the cell. None: Sets the cell to have no selected protocol. List of Instrument Protocols: In alpha-numeric order. <p>Note: You must select an Instrument Protocol for each sample entered in the Sample Name column. See “Results Group for Fragment Analysis” on page 101.</p>

Notes _____



Creating Protocols for Fragment Analysis

If the appropriate fragment analysis protocols and results group have been created, proceed to “Creating a GeneMapper® Software Plate Record” on page 109.

Instrument Protocol for Fragment Analysis

An instrument protocol contains all the settings necessary to run the instrument:

- Protocol name
- Type of run
- Run module
- Dye set

Creating an Instrument Protocol

1. In the tree pane of the Data Collection software, click **GA Instruments > ga3130x/ or ga3130 > Protocol Manager**.

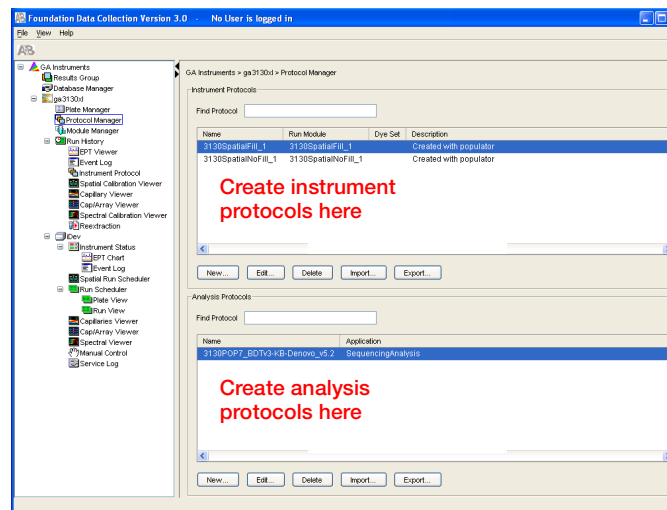

2. In the Instrument Protocols section, click **New...** to open the Protocol Editor.

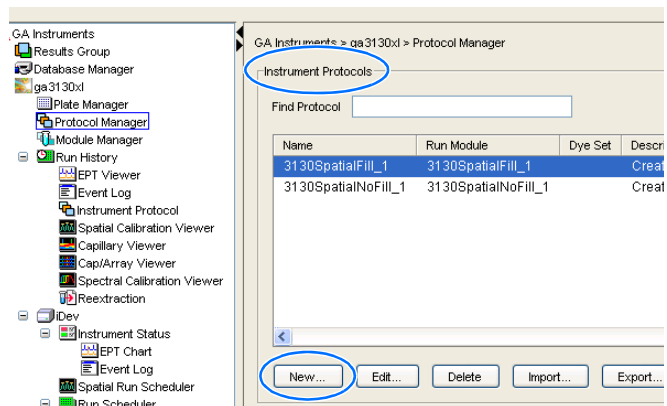

Notes _____

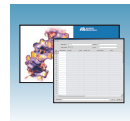

3. Complete the Protocol Editor:

- a. Type a name for the protocol.
- b. Type a description for the protocol (optional).
- c. Select **Regular** in the Type drop-down list.

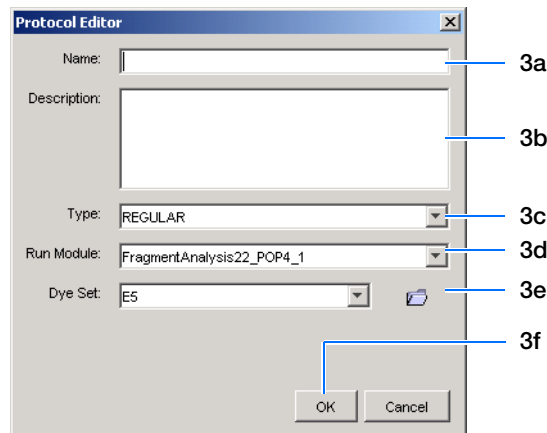

- d. Using the table below, select the run module for your run. To customize a run module, see the *Applied Biosystems 3130/3130xl Genetic Analyzers Maintenance, Troubleshooting, and Reference Guide* on modifying a module.

Application or Kit	Capillary Array Length (cm)	Run Module
<ul style="list-style-type: none"> • SNaPshot® Multiplex System 	22	SNP22_POP4_1
	36	SNP36_POP4_1
<ul style="list-style-type: none"> • Custom oligos • Stockmarks • AFLP® 	22	FragmentAnalysis22_POP4_1
	36	FragmentAnalysis36_POP4_1
		FragmentAnalysis36_POP7_1
	50	FragmentAnalysis50_POP4_1
		FragmentAnalysis50_POP6_1
FragmentAnalysis50_POP7_1		
<ul style="list-style-type: none"> • AmpFλSTR® COfiler® Kit • AmpFλSTR® Profiler Plus® Kit • AmpFλSTR® SGM Plus® Kit • AmpFλSTR® Profiler Plus <i>ID</i> Kit • AmpFλSTR® SEfiler™ Kit • AmpFλSTR® Yfiler® Kit • Other 4-Dye AmpFλSTR® Kits • AmpFλSTR® Identifiler Kit • AmpFλSTR® Identifiler Plus Kit • Other 5-Dye AmpFλSTR® Kits 	36	HIDFragmentAnalysis36_POP4_1

Notes



Application or Kit	Capillary Array Length (cm)	Run Module
<ul style="list-style-type: none"> • Single Strand Conformation Polymorphism (SSCP) Analysis using non-denaturing Conformational Analysis Polymer (CAP) 	36	ConformationAnalysis36_CAP

e. Using the table below, select the correct Dye Set for your run.

Application or Kit	Dye Set	Matrix Standard Set
<ul style="list-style-type: none"> • Custom oligos 	D	DS-30
<ul style="list-style-type: none"> • Custom oligos 	D	DS-31
<ul style="list-style-type: none"> • AmpFℓSTR® COfiler® Kit • AmpFℓSTR® Profiler Kit • AmpFℓSTR® Profiler Plus Kit • AmpFℓSTR® SGM® Plus Kit • AmpFℓSTR® Profiler Plus® ID Kit • Other 4-Dye AmpFℓSTR® Kits • AFLP® Kits • Stockmarks -Canine and Bovine 	F	DS-32
<ul style="list-style-type: none"> • SNaPshot® Multiplex System 	E5	DS-02
<ul style="list-style-type: none"> • Custom oligos • AmpFℓSTR® Identifiler® Kit • AmpFℓSTR® SEfiler™ Kit • AmpFℓSTR® Yfiler® Kit • Other 5-Dye AmpFℓSTR® Kits • AmpFℓSTR® Identifiler Plus Kit • AmpFℓSTR® Identifiler Direct Kit • AmpFℓSTR® Sinofiler Kit • AmpFℓSTR® MiniFiler Kit • AmpFℓSTR® NGM Kit • AmpFℓSTR® NGM Select Kit • Stockmarks-Equine 	G5	DS-33

f. Click .

Notes _____

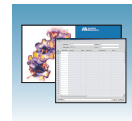

Importing an Instrument Protocol

1. Click **Import** in the Instrument Protocols pane of the Protocol Editor window to display the standard File Import dialog box.

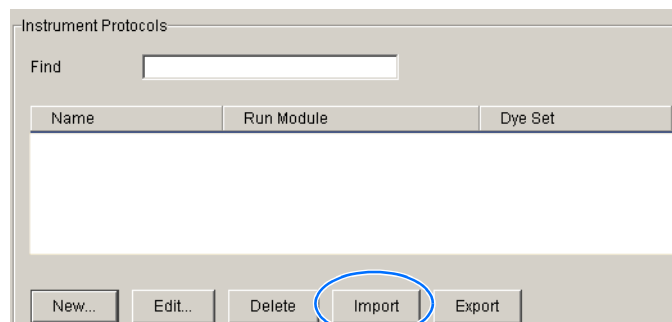

2. Navigate to the location of the .xml file you want to import.
3. Select the .xml file and click **Open**.

Exporting an Instrument Protocol

1. In the Instrument Protocols pane, highlight the protocol you want to export.
2. Click **Export** to display the standard File Export dialog box.
3. Browse to the desired folder location.
4. Click **Save**.

Results Group for Fragment Analysis

A Results Group is a component within Data Collection that organizes samples and certain user settings under a single name. It is called a Results Group because it is used to name, sort, and deliver samples that result from a run.

Notes _____



Creating a Results Group

1. In the tree pane of the Data Collection software, click **GA Instruments > Results Group**.
2. Click **New...** to open the Results Group Editor window.

Skip the Analysis and Automated Processing tabs, because Autoanalysis by GeneMapper is no longer supported. Click through the other tabs to complete them, as described below.

3. Complete the General tab:
 - a. Enter a unique Results Group Name to be used in naming and sorting sample files.
 - b. Optional: Enter a Results Group Owner to be used in naming and sorting sample files.
 - c. Optional: Enter a Results Group Comment.

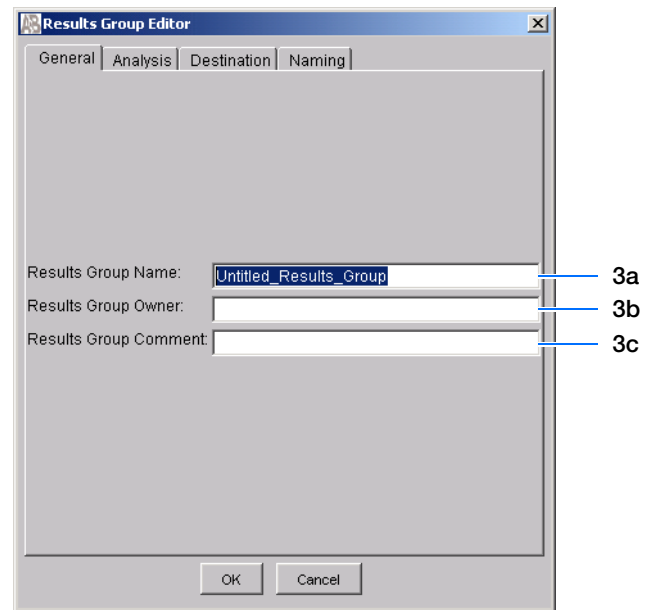
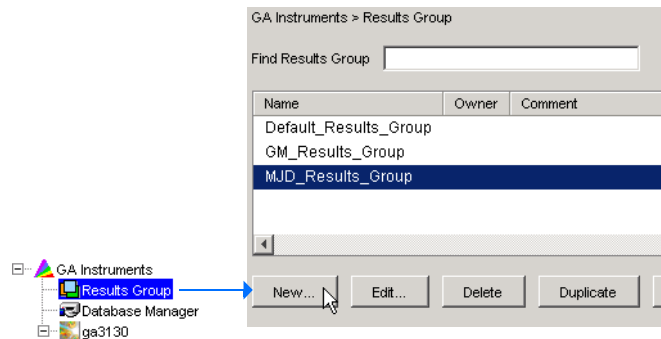

Notes _____

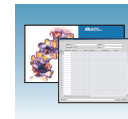

- Skip the Analysis tab, because autoanalysis by GeneMapper is no longer supported.

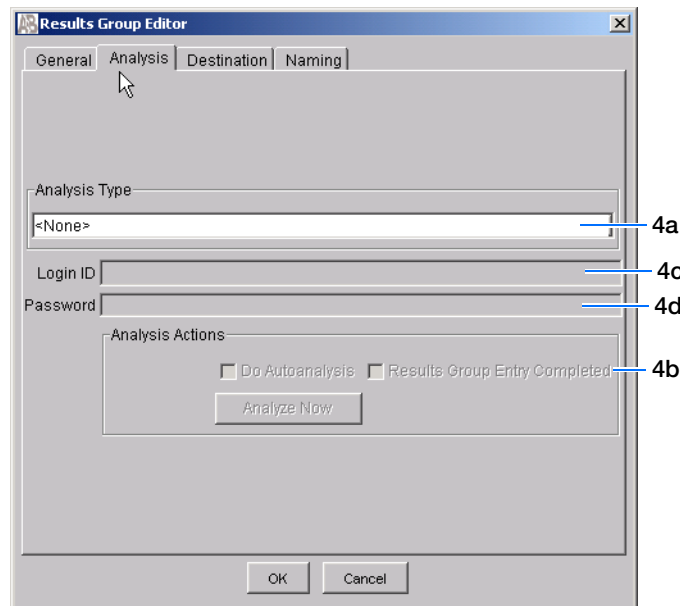

- Select the **Destination** tab, then use the default destination or define a new location for data storage.

To use a ...	Then ...
default location*	skip to step 6.
custom location	complete steps a–b.
<i>Use for remote analysis using GeneMapper v3.7</i>	

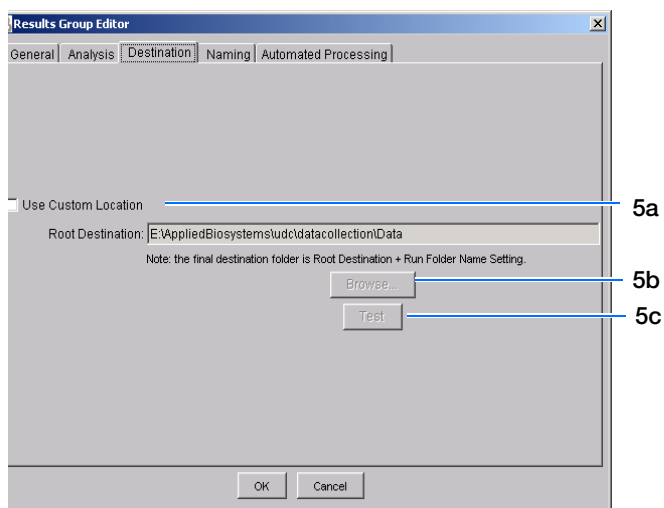

Note: The Results Group Editor Destination tab and Data Collection software will recognize remote storage locations if they have been mapped using the Map Network Drive. Specify the mapped drive path in the Root Destination field.

*Sample File Destinations

Locations where sample files are placed during extraction:

- Default Destination, default folder naming: E:\AppliedBiosystemsUDC\DataCollection\data<instrument type>\<instrument name>\run folder
- Default Destination, custom folder naming: E:\AppliedBiosystemsUDC\DataCollection\data\top custom folder\subfolders, etc.
- Custom Destination, default folder naming: Destination\<instrument type>\<instrument name>\run folder
- Custom Destination, custom folder naming: Destination\top customer folder\subfolders, etc.

Notes

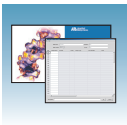

- a. Click **Use Custom Location**, then click **Browse...** to navigate to a different save location.
- b. Click **Test** to test the Location path name connection:

If it...	Then a message box displays ...
Passes	Test succeeded: <"path">.
Fails	Test failed:<"path">.

6. Select the **Naming** tab to customize sample file and run folder names.

Note: The default sample file naming for fragment analysis is:
 frag_<capillary number>_<wellposition>.fsa

Note: Sample name, run folder name, and path name, *combined*, can total no more than 250 characters.

For defining the elements of the Naming tab, see [page 104](#).

7. Skip the Automated Processing tab, because Autoanalysis by GeneMapper is no longer supported.
8. Click **OK** to save the Results Group.

Completing the Sample File Name Format Pane

1. Type a prefix for the file name in the **Prefix** box. Anything that you type here is shown in the Example line.

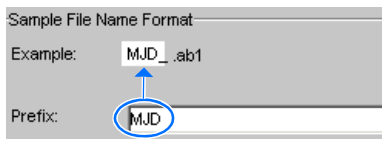
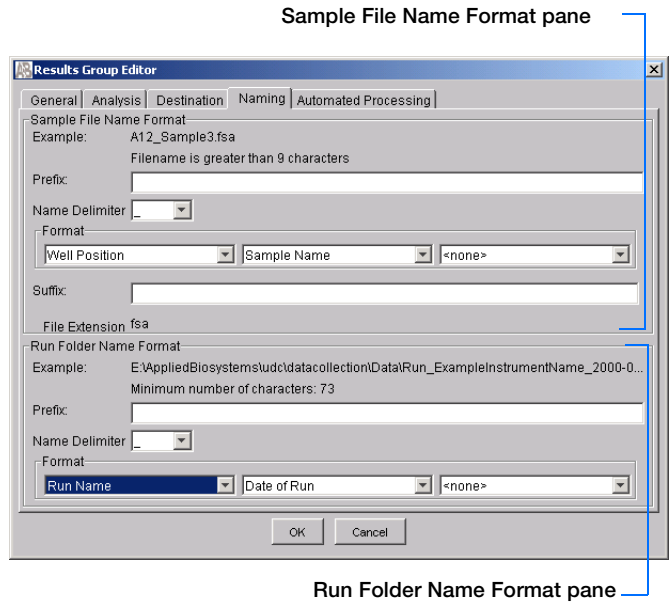

Notes _____

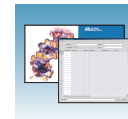

2. Click the **Name Delimiter** list choose the symbol that will separate the Format elements in the file name (see step 3 below). Only one delimiter symbol may be chosen.

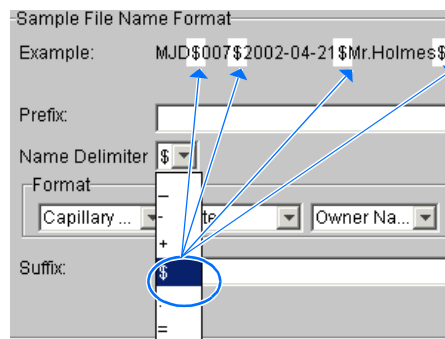

3. Click the Format list and then select the components that you want in the sample name.

Note: All the samples from a single run can be placed in the same run or results folder; the name of every sample from a single run should be different. Most of the Format options will not be different between samples; select at least one of the options to make the sample names unique within a run.

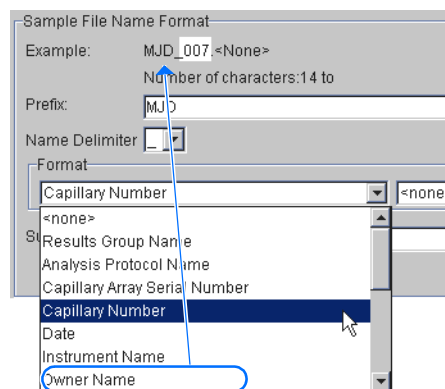

If a unique identifier is not included in the name, a warning message displays. Select from the elements to make a unique sample file name.

Examples are:

- Well position
- Capillary number
- Run sequence number
- Plate Quadrant

Note: Some identifiers, such as well position, capillary number and plate quadrant are not unique in multiple sample instances. Plate Quadrant is not a unique identifier for a 96-well plate.

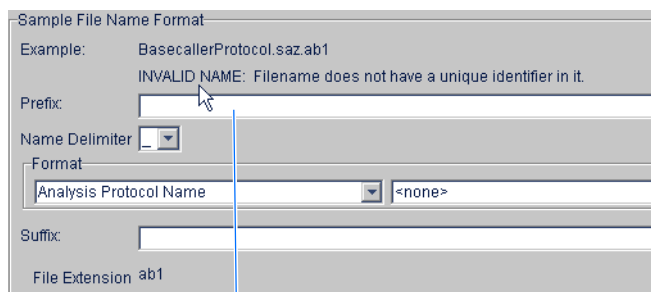

Warning message

Notes



As you select the elements for the file name, they are placed in the Example line. An additional element drop-down menu displays allowing you the option of selecting an additional element.

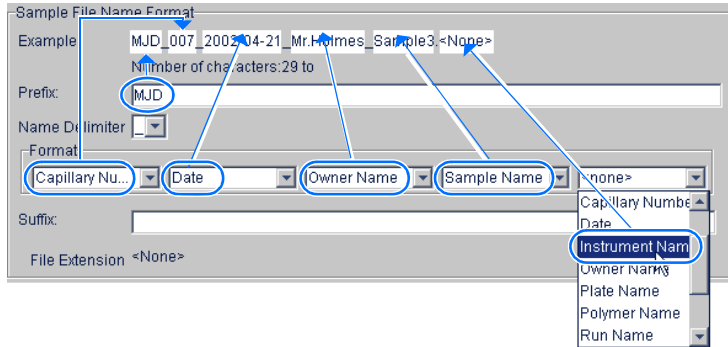

The names of the Format elements eventually truncate, but the Example field remains visible (up to 72 characters).

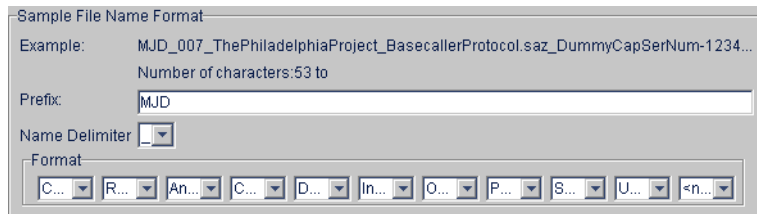

4. Click the Suffix box (optional) and type the suffix for the file name.

The File Extension field displays the file extension generated from the Analysis Type specified on the Analysis tab (see [page 103](#)). For example, Sequencing Analysis produces sample files with a .ab1 extension.

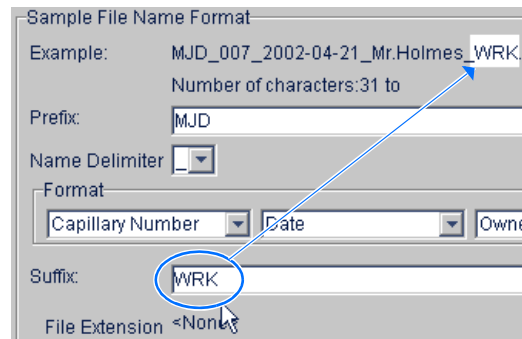

Run Folder/Sub-Folder Name Format Pane

Follow the same steps described above for the Sample File Name Format pane (see [page 104](#)) to change the sub-folder name within the run folder.

Notes

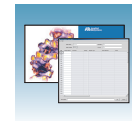

Importing and Exporting a Results Group

Importing or exporting of GeneMapper software Results Groups are not supported for transfer between separate computers.

Importing a Results Group

1. In the tree pane of the Data Collection software, click  **GA Instruments** >  **Results Group**.

2. Click  .

A standard File Import dialog box displays.

3. Navigate to the file you want to import.

Note: Import file type is .xml (XML file).

4. Click  .

Note: When you import or duplicate a Results Group, you are asked to type a name for the new Results Group and for the analysis application type.

Exporting a Results Group

1. In the tree pane of the Data Collection software, click  **GA Instruments** >  **Results Group**.

2. Click the Results Group name to select it.

3. Click  .

A standard file export dialog box displays with the chosen Results Group name.

4. Navigate to the location where you want to save the exported file.

5. Click  .

Note: If there is a name conflict with a Results Group that already exists at the save location, the Results groups can be duplicated in order to copy settings into a similar Results Group without the risk of user error when copying it manually (see [“Duplicating a Results Group” on page 108](#)).

Notes _____



Duplicating a Results Group

1. Click the Results Group.
2. Click **Duplicate** .

Note: When you import or duplicate a Results Group, you are asked to type a name for the new Results Group and for the analysis application type.

Notes _____



Creating a GeneMapper® Software Plate Record

Creating the Plate Record

1. In the tree pane of the Data Collection software, click **GA Instruments** > **ga3130x/** or **ga3130** > **Plate Manager**.
2. Click **New...** to open New Plate Dialog.
3. Complete the information in the New Plate Dialog:
 - a. Type a name for the plate.
 - b. Type a description for the plate (optional).
 - c. Select your GeneMapper application in the Application drop-down list.
 - d. Select **96-well** or **384-well** in the Plate Type drop-down list.
 - e. Type a name for the owner.
 - f. Type a name for the operator.
 - g. Click **OK**.
The GeneMapper software Plate Editor opens.

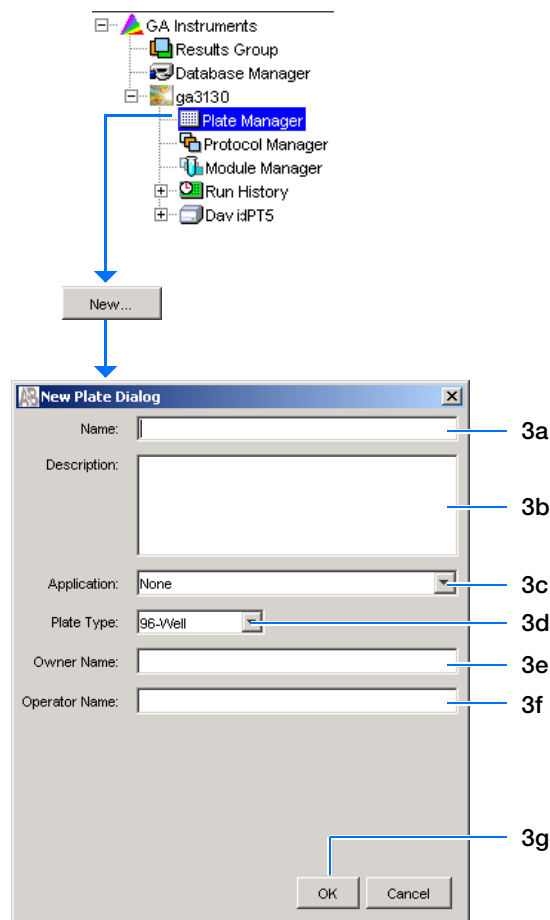

Notes



Completing a GeneMapper Software Plate Record

1. In the Sample Name column of a row, enter a sample name, then click the next cell. The value 100 automatically display in the Priority column.
2. In the Comment column, enter any additional comments or notations for the sample.
3. In the Priority column, you can change the priority value.
4. In the Sample Type column, select a sample type from the drop-down list.
5. In the Size Standard column, select a size standard from the drop-down list.

	1	2	3	4	5
Well	Sample Name	Comment	Priority	Sample Type	Size Standard
A01					
B01					
C01					
D01					
E01					
F01					

6. In the Panel column, select a panel from the drop-down list.
7. In the Analysis Method column, select a method from the drop-down list.
8. In the Snp Set column, select a SNP set from the drop-down list if applicable; otherwise select None.

	6	7	8	9	
Panel	Analysis Method	Snp Set	User-Defined 1	User-Defined 2	

9. Enter text for User-Defined columns 1 to 3.
10. In the Results Group 1 column, create a new Results Group or select a group from the drop-down list (see [page 102](#)).
11. In the Instrument Protocol 1 column, create a new instrument protocol or select a protocol from the drop-down list (see [page 98](#)).

	9	10	11
User-Defined 3	Results Group 1	Instrument Protocol 1	

Notes _____



12. To complete the plate record:

- For the same samples and protocols – Highlight the entire row, then select **Edit > Fill Down Special**.

Based on your plate type (96- or 384-well) and capillary array (16 or 4 capillaries), the software automatically fills in the appropriate well numbers for a single run.

- For the same samples and protocols – Highlight the entire row, then select **Edit > Fill Down**.
- For the different samples and protocols – Complete the entries manually.

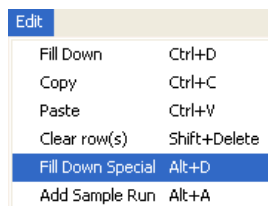

13. To do more than one run, select **Edit > Add Sample Run**.

Additional Results Group, Instrument Protocol and Analysis Protocol columns are added to the right end of the plate record.

Add additional runs by selecting **Edit > Add Sample Run** again.

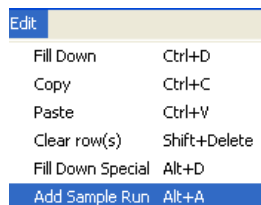

14. Complete the columns for the additional runs.

Notes _____

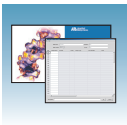

15. Click to save, then close the plate record.

IMPORTANT! After clicking OK in the Plate Editor, the plate record is stored in the Plate Manager database and can now be located, edited, exported, or deleted.

Note: If multiple cells are selected for copying, select the same number of corresponding target cells before you execute the Paste command.

Note: The Plate Editor Copy and Paste functionality is supported only within one plate editor. To copy and paste the contents of one plate to another plate, use the Duplicate ... button on the Plate Manager dialog box.

Note: If you use the duplicate plate function, all the information in the plate to be duplicated must be valid. Otherwise, an empty plate is created.

Notes _____



Running the Instrument

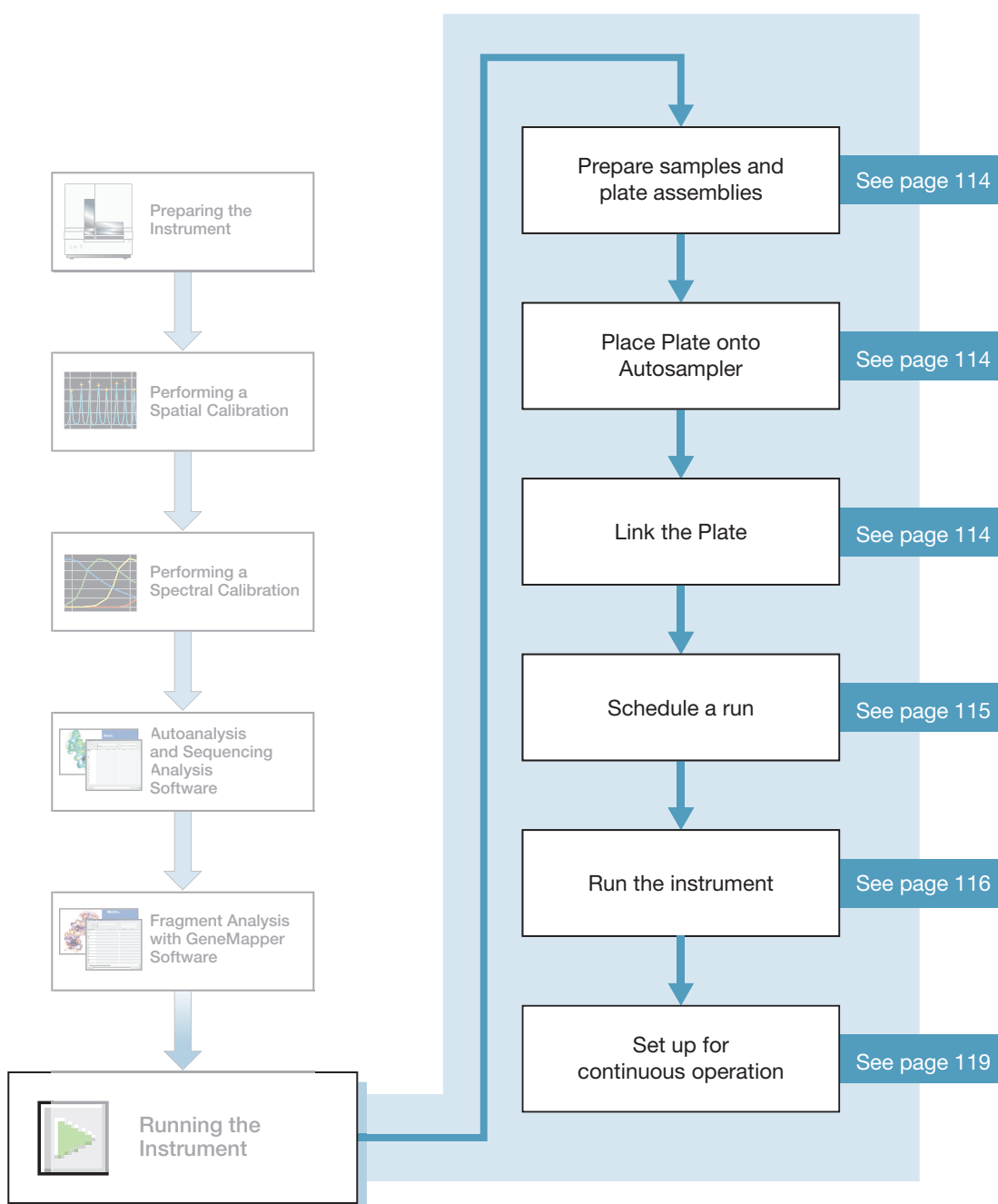

Notes _____



Preparing Samples and Plate Assemblies

Review Table

Generalized sample preparation and plate assembly procedures are discussed in [Chapter 3, “Performing a Spectral Calibration,”](#) on page 37.

Topic...	See
Sample Preparation	“Preparing the Calibration Standard” on page 41 and “Loading Samples” on page 42 to review handling samples. Follow your individual kit protocol to prepare sample load volume: 10 to 30 µL for a 96-well plate 5 to 15 µL for a 384-well plate
Sealing plates and plate assembly	“Seal the plate:” on page 43.
Placing plate assemblies in the instrument	“Placing the Plate Assembly into the Instrument” on page 49.
Searching for plate records to link to a plate	“Running the Spectral Calibration Plate” on page 50.

Linking and Unlinking a Plate

Link a plate on the autosampler to your newly created plate record before running the plate.

Select the desired plate record, then click the plate position indicator corresponding to the plate position in the instrument. The plate position (A or B) displays in the link column.

Note: The 3130 genetic analyzer has only one plate position (B) to link a plate record.

The plate position indicator changes from yellow to green when linked and the green run button  becomes active.

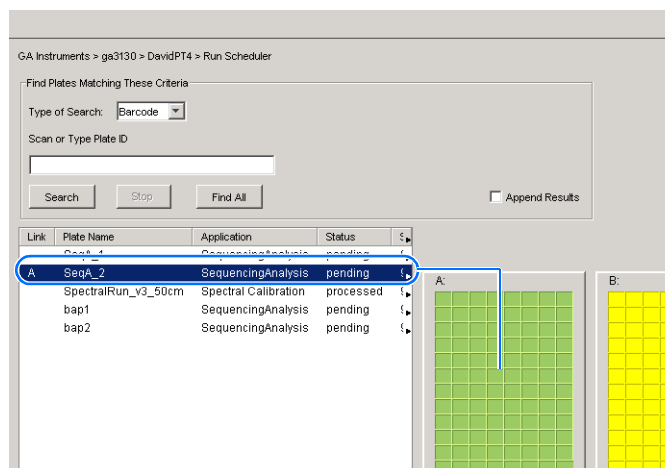

Notes



Unlinking a Plate Record

1. Click the plate record that you want to unlink.
2. Click **Unlink**.

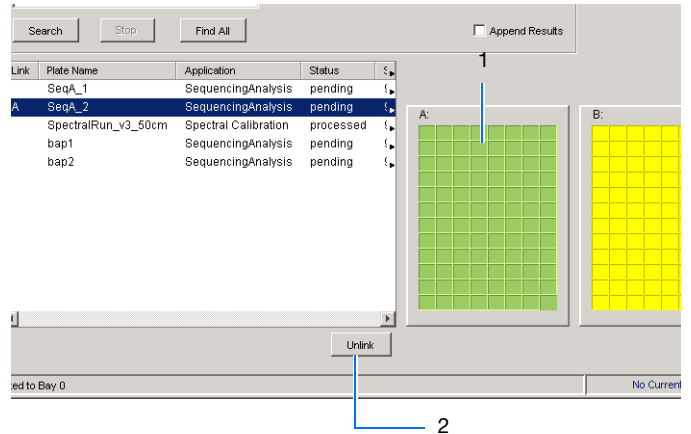

Viewing the Run Schedule

For more information on run scheduling and sample injection order, see “Plate Mapping” on page 141.

To verify that runs are scheduled correctly:

1. In the tree pane of the Data Collection software, click **GA Instruments** > **ga3130xl** or **ga3130** > **instrument name** > **Run Scheduler** > **Run View**.
2. Select a row for any run. The corresponding wells to be injected for that run are highlighted in the plate diagram.

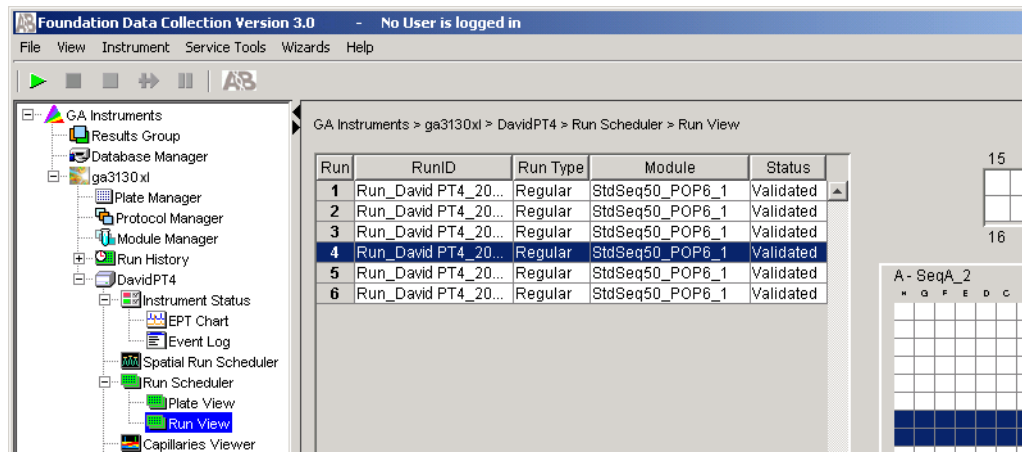

Notes _____



Running the Instrument

Starting the Run

1. Verify that the active spectral calibration matches your dye set and capillary array length for all scheduled runs.

To change the active spectral calibration, see [“Activating a Spectral Calibration” on page 57](#).

To create a new spectral calibration, see [“Creating a Spectral Instrument Protocol” on page 45](#).

2. Click the green button in the toolbar.
3. The Processing Plates dialog box opens, then click .

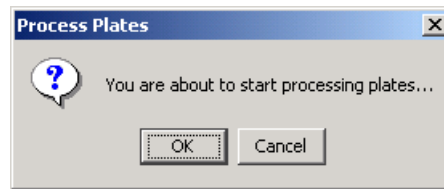

The software automatically performs a run validation:

- If the validation passes, the run starts
- If any of the validation test fails, the run does not start. Check the event log for information.

Notes _____



Basic Run Module Steps

Automated module steps when the run starts

Module Steps	Approximate Time
Turn Oven On	N/A
Wait for oven to equilibrate Initialize autosampler	1 min 40 sec
Fill Array	3-4 min
PreRun	3 min
Inject samples	10 to 30 sec
Start separation Ramp voltage	10 min
Collect Data	Variable
Run ends: Leave oven on Laser to idle	Until next run starts
Total time prior to separation:	
<ul style="list-style-type: none"> • Oven unheated: ~25 min • Oven at set temperature: ~6.5 min 	

To customize a run module, see the *Applied Biosystems 3130/3130xl Genetic Analyzers Maintenance, Troubleshooting, and Reference Guide*. (Part no. 4477854).

Note: The PostBatch Utility, which runs automatically, turns off both the oven and the laser at end of a batch of runs.

DNA Sequencing Run Times

Approximate run times of common DNA sequencing analysis runs

Type of Run	Run Module	Run Time (min)
Ultra rapid	UltraSeq36_POP4	40
	UltraSeq36_POP7	35
Rapid	RapidSeq36_POP6	60
	RapidSeq36_POP7	
Fast	FastSeq50_POP7	60
Standard	StdSeq50_POP4	100
	StdSeq50_POP6	150
	StdSeq50_POP7	120
Long read	LongSeq80_POP4	210
	LongSeq80_POP7	170

Notes _____



Fragment Analysis Run Times





Approximate run times of common fragment analysis runs

Type of Run	Run Modules	Run Time (min)
High Throughput, Small Size Fragment Analysis	FragmentAnalysis22_POP4	20
	SNP22_POP4	20
Standard Fragment Analysis	FragmentAnalysis36_POP4	45
	HIDFragmentAnalysis36_POP4	45
	SNP36_POP4	30
	FragmentAnalysis36_POP7	35
	FragmentAnalysis50_POP4	65
	FragmentAnalysis50_POP6	90
	FragmentAnalysis50_POP7	50
Large Size Fragment Analysis Run Modules	GS1200LIZ_36_POP7	125
	GS1200LIZ_50_POP7	135

Controlling the Run

Using the Toolbar Use the toolbar at the top of the data collection software window to control the run.



Click ...	Description
 Start Run	Starts the run
 Stop	Stops the current run, and all other scheduled runs
 Stop After Current Run	Completes the current run, then stops all other scheduled runs
 Skip to Next Run	Stops the current run, then starts the other scheduled runs

Notes _____



Click ...	Description
 Pause Run	Pauses the current run ^a

^a Pausing the instrument for too long, especially after sample injection, will adversely affect data quality.

Set Up for Continuous Operation

Overview Use the continuous run feature to create and link a plate during a run. You can:

- Run one or more plates
- Remove the plate(s) once samples have run
- Link and run additional plates

When using the continuous run feature:

- Only mount or unmount plates when the instrument is paused.
- Create the plate record before pausing the instrument to make linking more efficient, reducing long pauses.
- Link new plates after a run has resumed.

Adding or Replacing a Plate During a Run

During a run, you can mount and unmount plates while the instrument is paused. The plate record can be created, then linked after the run has been resumed.

If the plate is in use, see [“Adding, Replacing, or Removing a Plate During a Run” on page 120](#).

IMPORTANT! Pausing the instrument for too long, especially after sample injection, will affect data quality.

Notes _____



Adding, Replacing, or Removing a Plate During a Run

Replace a completed plate or add a new plate to an unused plate bay (3130xl genetic analyzer only).

1. Prepare your plate and create the plate record.
2. Click  (Pause).

In the Pause dialog box, read the pause warning, then click to pause the run.

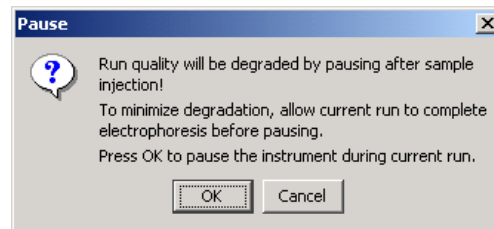

The Resume run dialog box opens when the run is paused.

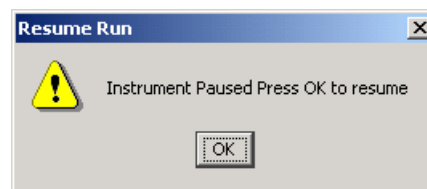

IMPORTANT! Do not click OK to resume the run. Temporarily ignore the dialog box.

3. Remove the old plate, if applicable.
 - a. Press the Tray button to bring the autosampler forward.
 - b. Open the instrument door.
 - c. Remove the old plate.
4. Mount the new plate.
5. Close the door.
6. Click **OK** in the Resume Run dialog box.
7. In the Completed Run dialog box, click to continue if the samples have been injected, or click to abort the run and return the instrument to an idle state.

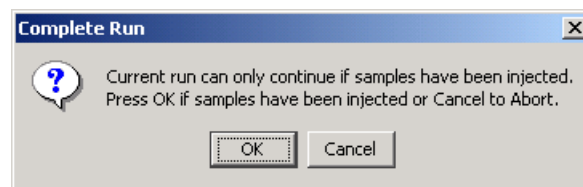

IMPORTANT! If you click OK, the instrument will continue running the current run regardless of whether the samples have actually been injected or not. If the samples have not been injected, the samples will be injected from the new plate.

Notes _____



8. Search for the plate record, then link the new plate.

The new plate runs after the current plate completes all scheduled injections.

Note: If you unmount the currently running plate prior to the first frame of data being collected but after sample injection (clicked OK to continue), the plate status changes to processed even though the run is actually continuing.

Notes _____



Viewing Data During a Run

Run Scheduler >
Plate View

In the tree pane of the Data Collection software, click
GA Instruments > ga3130xl or ga3130 > instrument name > Run Scheduler > Plate View.

Note: The Run Scheduler and Plate View windows display the same information.

Foundation Data Collection Version 3.0 - No User is logged in

GA Instruments > ga 3130xl > iDev > Run Scheduler > Plate View

Find Plates Matching These Criteria

Type of Search: Barcode

Scan or Type Plate ID

Search Find All Append Results

Link	Plate Name	Application	Status
	SEQsite29	SequencingAnalysis	pending-no samples defir
	SpectralZ_run3	Spectral Calibration	pending-no samples defir
	SpectralZrun2	Spectral Calibration	pending-no samples defir
	Spectral_Z_Run	Spectral Calibration	pending-no samples defir
	gpt-6	SeqScope	pending-no samples defir
	robin	GeneMapper	pending-no samples defir
	seqA	SequencingAnalysis	pending
	site23	SeqScope	pending-no samples defir
	testrun20	SeqScope	pending-no samples defir

A:

B:

System Status Plate A, 96 well mounted No Current Run

Notes _____



**Run Scheduler >
Run View**

In the tree pane of the Data Collection software, click **GA Instruments > ga3130xl** or **ga3130 > instrument name > Run Scheduler > Run View** to monitor the status of the scheduled runs.

The screenshot shows the 'Run Scheduler > Run View' window in the Foundation Data Collection software. The window title is 'GA Instruments > ga3130xl > DavidPT4 > Run Scheduler > Run View'. The interface includes a tree pane on the left, a central table of runs, a plate layout grid on the right, and buttons for selecting sites.

Run	RunID	Run Type	Module	Status
1	Run_David PT4_20...	Regular	StdSeq50_POP6_1	Validated
2	Run_David PT4_20...	Regular	StdSeq50_POP6_1	Validated
3	Run_David PT4_20...	Regular	StdSeq50_POP6_1	Validated
4	Run_David PT4_20...	Regular	StdSeq50_POP6_1	Validated
5	Run_David PT4_20...	Regular	StdSeq50_POP6_1	Validated
6	Run_David PT4_20...	Regular	StdSeq50_POP6_1	Validated

The plate layout grid shows a 12x16 grid with columns labeled H, G, F, E, D, C, B, A and rows labeled 1 through 12. A blue shaded area is visible in the grid, indicating the current run's position. Below the grid are buttons for 'Site 2', 'Site 4', 'Site 1', and 'Site 3'. The status bar at the bottom indicates 'Plate SeqA_2 has been linked to Bay 0' and 'No Current Run'.

Note: For default load maps, see [Appendix A, “Plate Mapping.”](#)

Notes



Instrument Status

In the tree pane of the Data Collection software, click

GA Instruments > **ga3130xl** or **ga3130** > **instrument name** > **Instrument Status** to monitor the status of the instrument or the current run.

Open the Event Log to monitor system messages

System Status must be 'Ready' before a run starts

Array and polymer information

The screenshot shows the 'Instrument Status' window for instrument '3130-019'. The 'Status Overview' section shows: Instrument ID: 3130-019, Run ID: Run_3130-019_2003-09-05_17-46_0122, Plate Name: seq_1_2, and System Status: Processing. The 'Sensor States' section shows: Laser: On, EP: On, Oven: On, Front Doors: Closed, Oven Door: Closed, and Autosampler: Return. The 'Sensor Values' section shows: EP Voltage (12.2 kV), EP Current (68.0 µA), Laser Power (15.0 mW), Laser Current (5.5 A), and Oven Temp (50.0 °C). The 'Events' section shows a list of status changes for various runs. The 'Array and polymer information' section shows: Array Serial Number: cap50, Array Length: 50 cm, Array Usage: 122, and Polymer Type: POP6. The 'System Status' at the bottom left is shown as a green arrow pointing right, with a tooltip that says 'Plate seq_1_3 has been linked to Bay 1'. The 'Est. 80%, 0:26:01 remaining.' is shown at the bottom right.

System Status changes from green to flashing red when errors occur, see Event Log.

Notes



Instrument Condition Sensor States Pane

The color of the indicator provides a quick way to check the status of the item to the left. See the table below for a definition of each color.

For...	A green box indicates...	A red box indicates...	A yellow box indicates...
Laser	Laser is off	Laser is on	Laser is idle
EP	Electrophoresis is off	Electrophoresis is on	—
Oven	Oven is off	Oven is on	—
Front Doors	Doors are closed	Doors are open	—
Oven Door	Door is closed	Door is open	—
Autosampler	Autosampler is homed	Autosampler is forward	—

Events Box

The Events box lists the:

- Instrument’s recent actions
- Status of each capillary as passed or failed at the end of a spectral calibration
- Calibration data at the end of a spatial calibration

Some of the events listed in the Events box provide information for service engineers.

Errors Box

The Errors box lists errors that have occurred during the current run.

Some of the error messages provide information for service engineers. A “fatal” error usually requires that you restart the data collection software.

Notes _____



Chapter 6 Running the Instrument

Set Up for Continuous Operation

Instrument Status > EPT Chart

In the tree pane of the Data Collection software, click **GA Instruments** > **ga3130xl** or **ga3130** > **instrument name** > **Instrument Status** > **EPT Chart**. The EPT chart displays real-time electrophoresis (EP) data during a run.

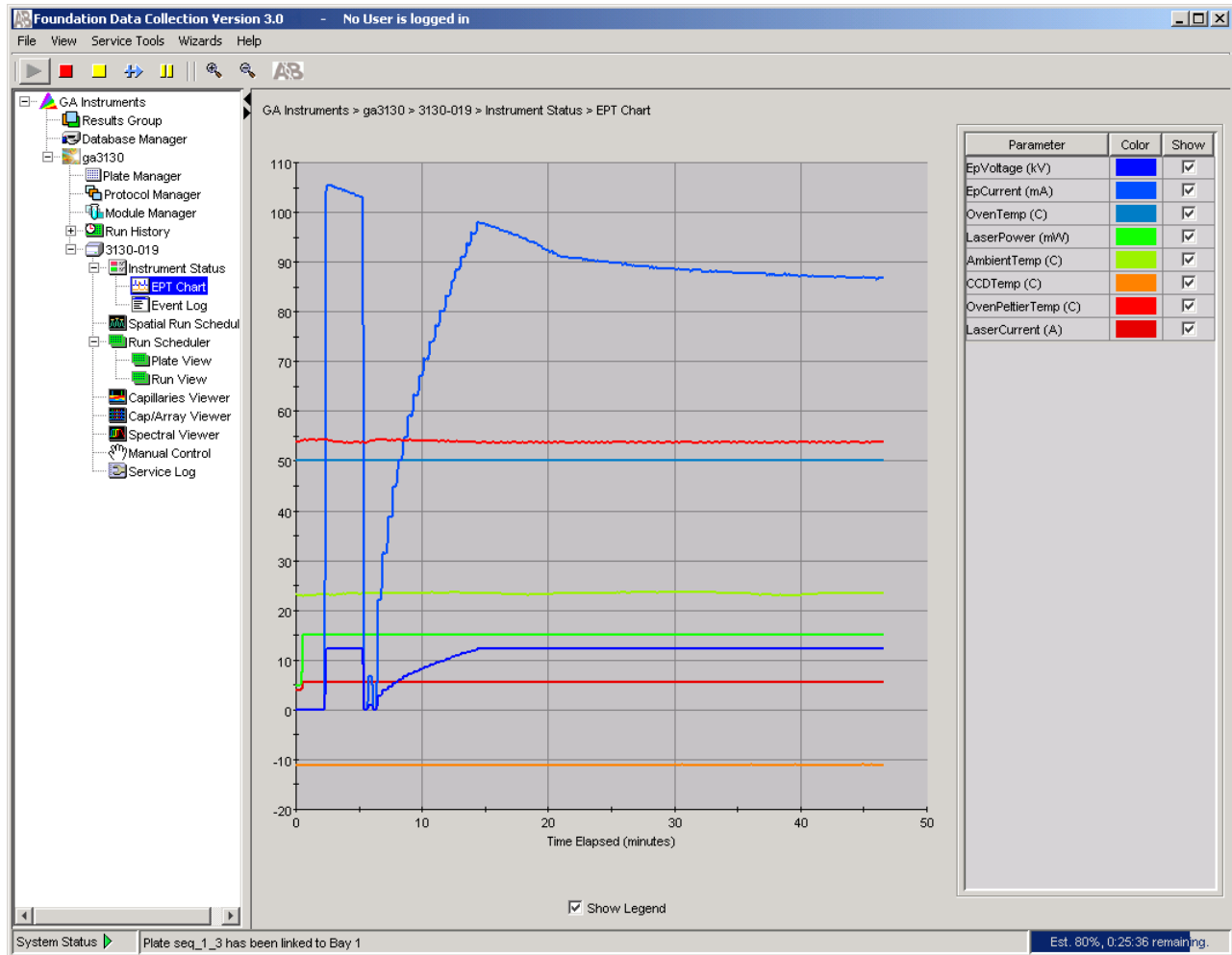

Notes



Instrument Status > Event Log

In the tree pane of the Data Collection software, click **GA Instruments > ga3130xl or ga3130 > instrument name > Instrument Status > Event Log**. The Event log itemizes events such as errors and general information for all data collection steps.

Clear error messages by clicking **Clear Errors**. The System Status light flashes red until all errors are cleared. Take corrective action based on error message.

Note: This view can also be used to monitor spectral calibration results in real time to verify the capillary-by-capillary processing status.

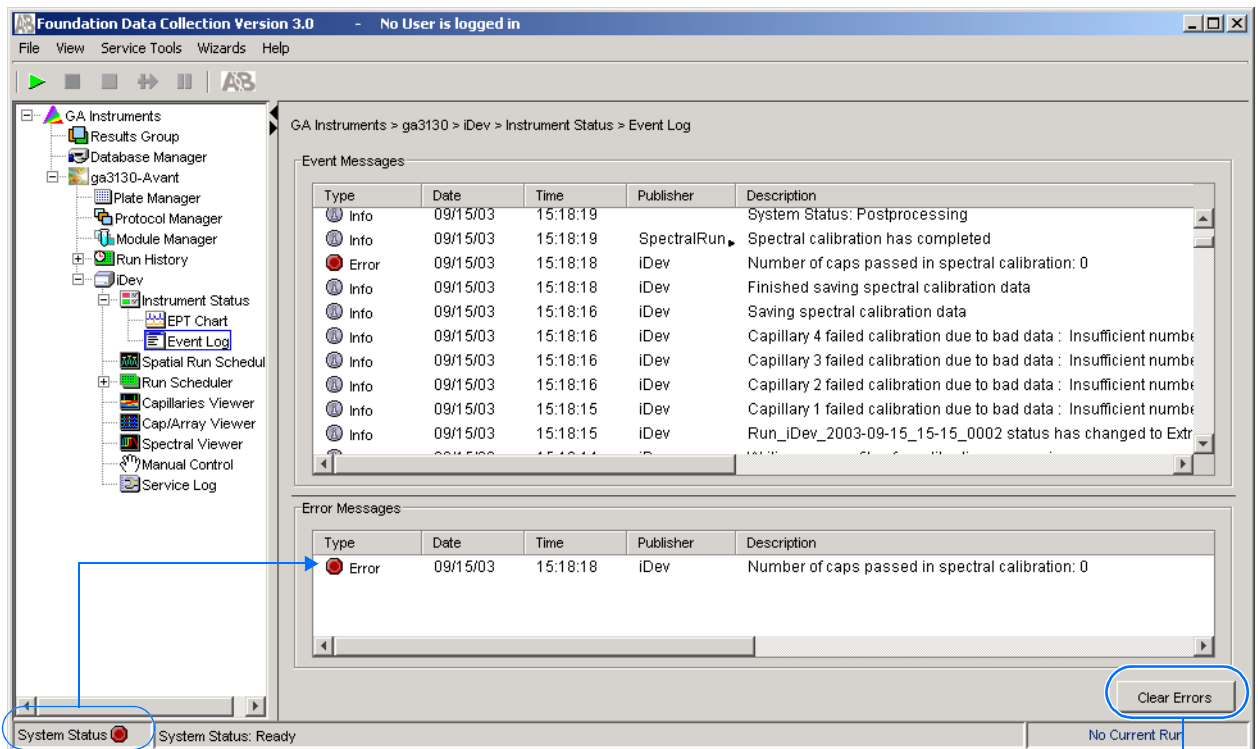

Clear Errors changes the System status from red to green (ready state).

Notes



Capillaries Viewer

In the tree pane of the Data Collection software, click **GA Instruments** > **ga3130** or **ga3130xl** > **instrument name** > **Capillaries Viewer**. Use the Capillary Viewer to examine the quality of the raw data during a run for several capillaries at once.

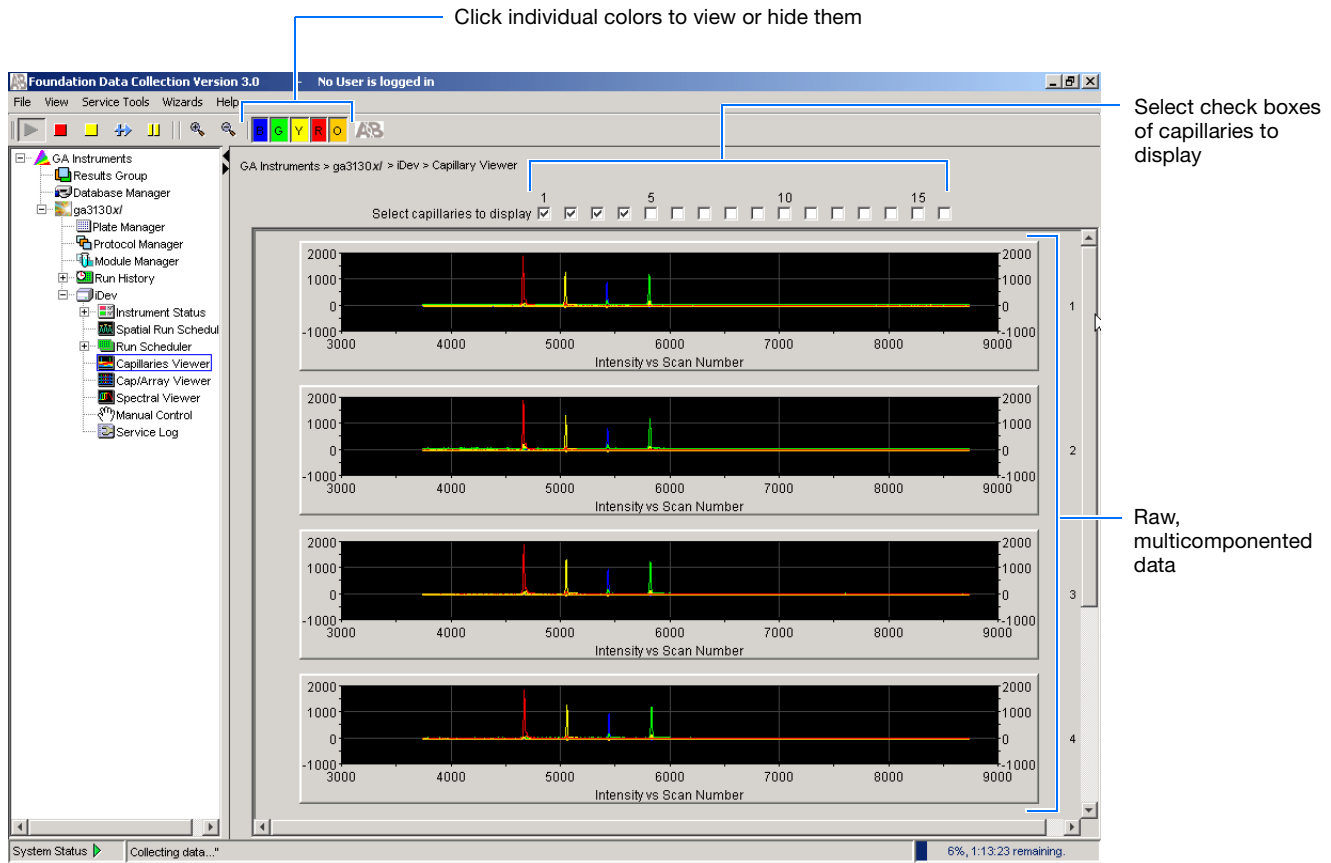

Check Boxes

Select the check boxes of the capillaries to view their electropherograms. The capillaries are displayed in the order in which the boxes are checked. The more boxes that are selected, the slower the refresh window rate.

Raw Data

An electropherogram is a graph of relative dye concentration against time, plotted for each dye. The displayed raw data has been corrected for spectral overlap (multicomponented).

How to Zoom

To zoom in and out:

1. Select a rectangular area over the area of interest by holding down the mouse button. Release the mouse button to zoom in.
2. Click  to return to full view.

Notes



Cap/Array Viewer

In the tree pane of the Data Collection software, click **GA Instruments > ga3130** or **ga3130xl > instrument name > Cap/Array Viewer**. Use the window during a run to examine the quality of your data, which is displayed as color data for the entire capillary array. You can view all the capillaries (vertical axis) as a function of time/scan numbers (horizontal axis).

Click individual colors to view or hide them

Raw data display for selected capillary (4)

Electropherogram displays

Capillary order

0 ————— End

How to Zoom

To zoom in and out:

1. Select a rectangular area over the area of interest by holding down the mouse button. Release the mouse button to zoom in.
2. Click  to return to full view.

Notes



Working with Data in The Run History View









Run History Components

Elements of the Run History Utility

Use the Run History utility only with completed runs stored in the local 3130/3130x/ genetic analyzer Data Collection database. It does not provide real-time viewing of collecting runs.

In the left tree pane, click the icon next to the function to launch it.

Elements Within the Run History Utility

Icon	Element	Displays the...
	EPT Viewer	Electrophoresis data of the run, such as voltage, current, and oven temperature profiles.
	Event Log	Event messages associated with the run.
	Instrument Protocol	Instrument protocol and run module settings used for the run.
	Spatial Calibration Viewer	Spatial calibration associated with the run.
	Capillaries Viewer	Individual electropherogram for each sample in the run.
	Cap/Array Viewer	Array view of the run.
	Spectral Viewer	Spectral calibration used for the run.
	Reextraction	Extraction and analysis status for all samples in the run. See “Viewing Autoextraction Results” on page 132 for more details.

Note: If Cleanup Database has been used, you cannot view processed data in Run History.

Notes _____



Viewing Data from a Completed Run in the Data Collection Software

View data using two formats within the 3130 Series Data Collection Software 4, under the Run History icon:

- In the Cap/Array Viewer window (in much the same way that you might view the gel file output from an ABI PRISM® slab gel instrument).
- In the Capillary Viewer window, capillary-by-capillary.

Viewing Data from a Completed Run

1. In the tree pane of the Data Collection software, click **GA Instruments** > **ga3130xl** or **ga3130** > **Run History** to select the run you want to view.
2. Search for your run by either Barcode or Advanced search.
3. After choosing the run, click the run history elements, such as Cap/Array Viewer or the Capillary Viewer from the left tree pane to look at the run data.

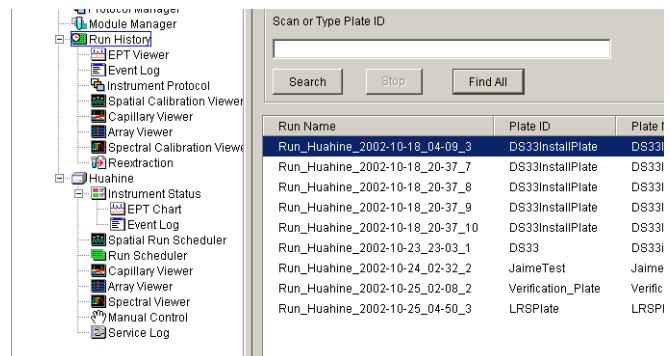

Notes



Viewing Autoextraction Results

Overview After a run is completed, extraction and analysis is performed automatically, using the settings in the Plate Editor and the Results Group. View the results of extraction and analysis in the Reextraction Panel. Reextract samples with the same settings, or with different Analysis Protocols or Results Groups. This process can be useful for many reasons:

- The destination location may not have been available during extraction.
- Some samples may have failed analysis and a different Analysis Protocol might be more successful.
- Samples might be saved in different locations, or with no analysis at all to save space.
- Sample names may need to be edited.

Sample File Destinations Locate the Results Group's Naming Tab and check the Destination Tab and Run Folder Name Format to find the sample file destination.

Effects of Changes Made in the Reextraction Panel Changes made in the Reextraction Panel to a Results Group, Analysis protocol, sample names, or Comments, also change in the original plate record. The original plate information is overwritten.

Notes _____



Selecting and Queuing Samples for Extraction

Queue individual samples for reextraction to experiment with different Analysis Protocols for samples that have failed initial extraction.

1. Click  (Run History).
2. Enter the plate name for a plate that has been completed, or click **Search**. Plates that have runs still pending cannot be reextracted. All the runs from that plate appear in the window.
3. Select a run from the list.

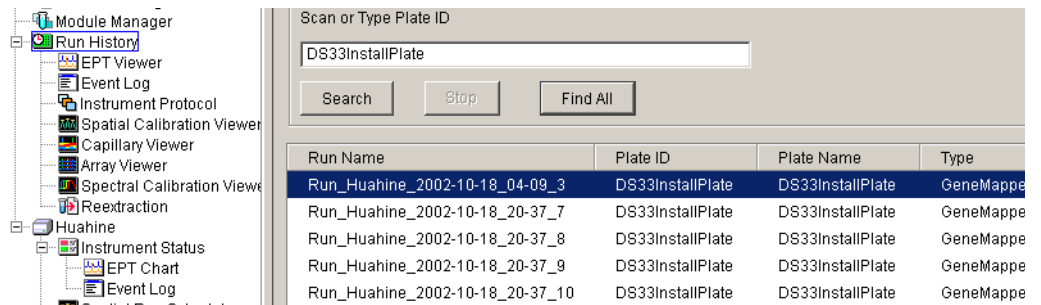

Run Name	Plate ID	Plate Name	Type
Run_Huahine_2002-10-18_04-09_3	DS33InstallPlate	DS33InstallPlate	GeneMappe
Run_Huahine_2002-10-18_20-37_7	DS33InstallPlate	DS33InstallPlate	GeneMappe
Run_Huahine_2002-10-18_20-37_8	DS33InstallPlate	DS33InstallPlate	GeneMappe
Run_Huahine_2002-10-18_20-37_9	DS33InstallPlate	DS33InstallPlate	GeneMappe
Run_Huahine_2002-10-18_20-37_10	DS33InstallPlate	DS33InstallPlate	GeneMappe

4. Click  (Reextraction) in the left tree pane to display the Reextraction window.
5. Click the check boxes in the Extract column to select the samples to be reextracted.
6. Click **Extract** to start the reextraction.

Note: Reextracted sample files are saved in the original folder that data was extracted to unless this destination was changed through the Results Group.

Notes _____



Elements of the Reextraction Window

All the samples are displayed with the results of extraction and analysis.

Note: Sort the columns of the re-extraction panel by holding the shift key and then clicking on a column header.

Reextraction Window for Sequencing Analysis

Use check boxes to select samples to be reextracted

Select a run

Results of extraction and analysis

GA Instruments > ga3130x1 > Run History > Reextraction

Select a run to view: Run_DavidPT5_2003-07-08_14-16_0004

Extract	Cap	Well	Extraction Res	Results Group	Analysis Protocol	Analysis Result	Score	Sample Name	C
<input checked="" type="checkbox"/>	1	A01	SUCCESS: Extr	seqa	3130POP6_BDTv3-KB-De	SUCCESS: Analysis Succ	31.048977	s	
<input checked="" type="checkbox"/>	3	B01	SUCCESS: Extr	seqa	3130POP6_BDTv3-KB-De	SUCCESS: Analysis Succ	30.7	s	
<input checked="" type="checkbox"/>	5	C01	SUCCESS: Extr	seqa	3130POP6_BDTv3-KB-De	SUCCESS: Analysis Succ	30.370401	s	
<input checked="" type="checkbox"/>	7	D01	SUCCESS: Extr	seqa	3130POP6_BDTv3-KB-De	SUCCESS: Analysis Succ	31.201584	s	
<input checked="" type="checkbox"/>	9	E01	SUCCESS: Extr	seqa	3130POP6_BDTv3-KB-De	SUCCESS: Analysis Succ	30.77367	s	
<input checked="" type="checkbox"/>	11	F01	SUCCESS: Extr	seqa	3130POP6_BDTv3-KB-De	SUCCESS: Analysis Succ	30.596704	s	
<input checked="" type="checkbox"/>	13	G01	SUCCESS: Extr	seqa	3130POP6_BDTv3-KB-De	SUCCESS: Analysis Succ	30.43482	s	
<input checked="" type="checkbox"/>	15	H01	SUCCESS: Extr	seqa	3130POP6_BDTv3-KB-De	SUCCESS: Analysis Succ	30.161997	s	
<input checked="" type="checkbox"/>	2	A02	SUCCESS: Extr	seqa	3130POP6_BDTv3-KB-De	SUCCESS: Analysis Succ	30.684116	s	
<input checked="" type="checkbox"/>	4	B02	SUCCESS: Extr	seqa	3130POP6_BDTv3-KB-De	SUCCESS: Analysis Succ	30.889853	s	
<input checked="" type="checkbox"/>	6	C02	SUCCESS: Extr	seqa	3130POP6_BDTv3-KB-De	SUCCESS: Analysis Succ	31.220848	s	
<input checked="" type="checkbox"/>	8	D02	SUCCESS: Extr	seqa	3130POP6_BDTv3-KB-De	SUCCESS: Analysis Succ	30.625536	s	
<input checked="" type="checkbox"/>	10	E02	SUCCESS: Extr	seqa	3130POP6_BDTv3-KB-De	SUCCESS: Analysis Succ	30.507118	s	
<input checked="" type="checkbox"/>	12	F02	SUCCESS: Extr	seqa	3130POP6_BDTv3-KB-De	SUCCESS: Analysis Succ	30.35501	s	
<input checked="" type="checkbox"/>	14	G02	SUCCESS: Extr	seqa	3130POP6_BDTv3-KB-De	SUCCESS: Analysis Succ	31.815218	s	
<input checked="" type="checkbox"/>	16	H02	SUCCESS: Extr	seqa	3130POP6_BDTv3-KB-De	SUCCESS: Analysis Succ	31.374426	s	

Extract... Click here to start extraction

Check Uncheck

Use these buttons if several samples are highlighted

Notes



Reextraction Window for Fragment Analysis

Use check boxes to select samples to be reextracted

Select a run

Results of extraction

Extract	Cap	Well	Extraction Result	Results Group	Sample Name	Comment	Sample Type	Size Standard	Pt
<input checked="" type="checkbox"/>	1	A01	SUCCESS: Extr.	gm_runbyrun	s		Sample	GS500LIZ	D:
<input checked="" type="checkbox"/>	3	B01	SUCCESS: Extr.	gm_runbyrun	s		Sample	GS500LIZ	D:
<input checked="" type="checkbox"/>	5	C01	SUCCESS: Extr.	gm_runbyrun	s		Sample	GS500LIZ	D:
<input checked="" type="checkbox"/>	7	D01	SUCCESS: Extr.	gm_runbyrun	s		Sample	GS500LIZ	D:
<input checked="" type="checkbox"/>	9	E01	SUCCESS: Extr.	gm_runbyrun	s		Sample	GS500LIZ	D:
<input checked="" type="checkbox"/>	11	F01	SUCCESS: Extr.	gm_runbyrun	s		Sample	GS500LIZ	D:
<input checked="" type="checkbox"/>	13	G01	SUCCESS: Extr.	gm_runbyrun	s		Sample	GS500LIZ	D:
<input checked="" type="checkbox"/>	15	H01	SUCCESS: Extr.	gm_runbyrun	s		Sample	GS500LIZ	D:
<input checked="" type="checkbox"/>	2	A02	SUCCESS: Extr.	gm_runbyrun	s		Sample	GS500LIZ	D:
<input checked="" type="checkbox"/>	4	B02	SUCCESS: Extr.	gm_runbyrun	s		Sample	GS500LIZ	D:
<input checked="" type="checkbox"/>	6	C02	SUCCESS: Extr.	gm_runbyrun	s		Sample	GS500LIZ	D:
<input checked="" type="checkbox"/>	8	D02	SUCCESS: Extr.	gm_runbyrun	s		Sample	GS500LIZ	D:
<input checked="" type="checkbox"/>	10	E02	SUCCESS: Extr.	gm_runbyrun	s		Sample	GS500LIZ	D:
<input checked="" type="checkbox"/>	12	F02	SUCCESS: Extr.	gm_runbyrun	s		Sample	GS500LIZ	D:
<input checked="" type="checkbox"/>	14	G02	SUCCESS: Extr.	gm_runbyrun	s		Sample	GS500LIZ	D:
<input checked="" type="checkbox"/>	16	H02	SUCCESS: Extr.	gm_runbyrun	s		Sample	GS500LIZ	D:

Use these buttons if several samples are highlighted

Notes



Results Column The results of extraction and analysis are color coded in the Results column. The following table lists the colors and their values for Sequencing Analysis.

Color	Value
Red	Extraction or analysis failed Note: Descriptive messages can be viewed by resizing the Results column to view all text.
Yellow	Warnings for extraction or analysis Note: Descriptive messages can be viewed by resizing the Results column to view all text.
Green	Successful extraction (with no analysis intended), or successful extraction and analysis.

The Results column, by default, shows only the beginning of any processing message. The entire message and the sample file location can be viewed by expanding the cell. There is a tooltip view for each sample results message.

Tooltip view. Access by placing the cursor over the sample of interest

Foundation Data Collection Version 3.0 - No User is logged in

GA Instruments > ga3130xl > Run History > Reextraction

Select a run to view: Run_DavidPT2_2004-10-29_19-19_0005

Extract	Cap	vWell	Extraction Result	Results Group	Analysis Protocol	Analysis Result	Score
<input checked="" type="checkbox"/>	1	A01	SUCCESS: Extr	SeqA-auto	3130POP7_BDTv3-KB-De	SUCCESS: Analysis Succ	29.672728
<input checked="" type="checkbox"/>	3	B01	SUCCESS: Extr	SeqA-auto	3130POP7_BDTv3-KB-De	SUCCESS: Analysis Succ	52.34312
<input checked="" type="checkbox"/>	5	C01	SUCCESS: Extr	SeqA-auto	3130POP7_BDTv3-KB-De	SUCCESS: Analysis Succ	52.317997
<input checked="" type="checkbox"/>	7	D01	SUCCESS: Extr	SeqA-auto	3130POP7_BDTv3-KB-De	SUCCESS: Analysis Succ	3.0
<input checked="" type="checkbox"/>	9	E01	SUCCESS: Extr	SeqA-auto	3130POP7_BDTv3-KB-De	SUCCESS: Analysis Succ	53.78796
<input checked="" type="checkbox"/>	11	F01	SUCCESS: Extr	SeqA-auto	3130POP7_BDTv3-KB-De	ERROR: Analysis Failed	<NA>
<input checked="" type="checkbox"/>	13	G01	SUCCESS: Extr	SeqA-auto	3130POP7_BDTv3-KB-De	SUCCESS: Analysis Succ	36.262295
<input checked="" type="checkbox"/>	15	H01	SUCCESS: Extr	SeqA-auto	3130POP7_BDTv3-KB-De	SUCCESS: Analysis Succ	54.028168
<input checked="" type="checkbox"/>	2	A02	SUCCESS: Extr	SeqA-auto	3130POP7_BDTv3-KB-De	SUCCESS: Analysis Succ	5.0

File: (E:\AppliedBiosystems\udc\datacollection\data\ga3130xl\DavidPT2\Run_DavidPT2_2004-10-29_19-19_0005\seq_005_C01.ab1)

Drag the cell's edge to expand the column

Notes

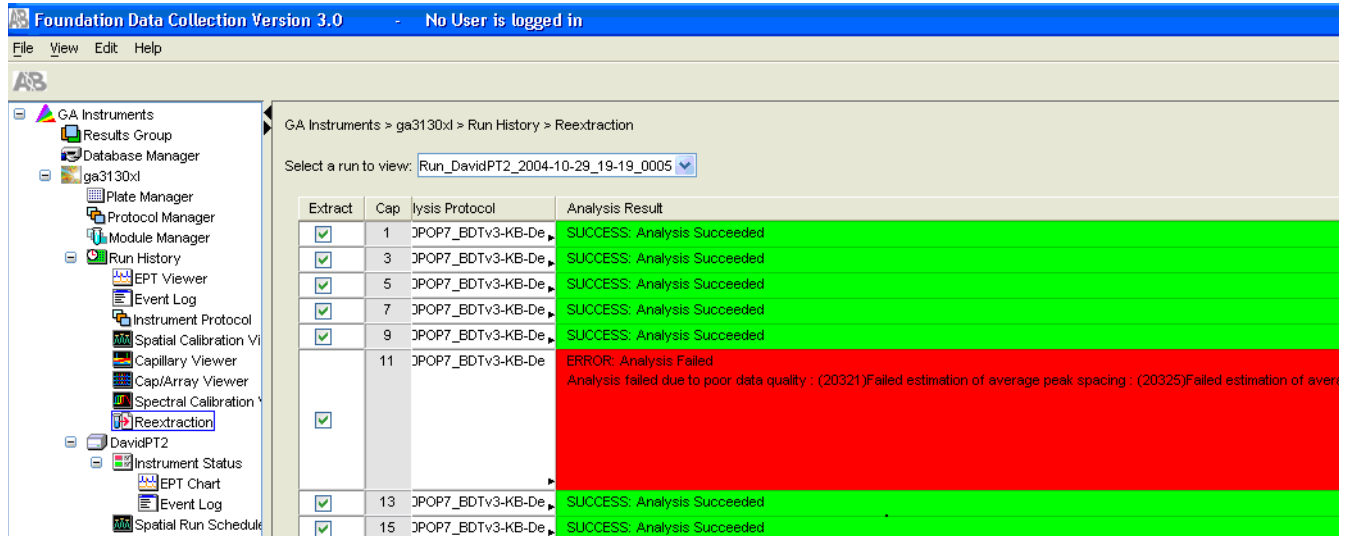

Expanded column

Quality Column

The Quality column represents the quality values for an entire sequence. Quality Values are only assigned to analyzed samples when using the KB™ Basecaller.

Colors displayed and their associated value range

Color	Quality Value Range
Red	< 15
Orange	≥ 15 and < 20
Yellow	≥ 20 and < 30
Green	> 30

Note: For more information on KB Basecaller and Quality Values, see the *Applied Biosystems DNA Sequencing Analysis Software v5.1 User Guide*, PN 4346366.

The column is empty (white) if:

- Analysis was not performed
- Analysis failed
- ABI Basecaller was used for analysis. This basecaller does not assign Quality Values.

Notes



Results Group and Analysis Protocol Columns

You can edit and make changes for reextraction to the Results Group and the Analysis Protocol (Analysis Method in the GeneMapper® software).

Note: Select an entire column in the Reextraction window by clicking on the column header. For example, clicking on the Extract column header selects all samples. Clicking the Uncheck or Check buttons at the bottom of the window, enables or disables the check boxes for each sample. The fill-down command (**Ctrl+D**) works the same here as in the Plate Editor for easier information input.

Sorting the Samples

1. Hold down the shift key while clicking on the column header to sort samples according to the column properties.
2. Shift-click again to sort them in reverse order.
Sort by:
 - Capillary number
 - Well position
 - Results
 - Quality
 - Extract column

Note: For example, bring all of the failed analysis or extraction samples to the top of the column. Now they can be viewed without having to scroll down to each sample individually.

Notes _____



Reextracting Selected Samples

1. Expand the Results column cells for any yellow or red results to see a description of the warning or failure.
2. You can select a new Results Group, or edit the current one. Selecting a new Results Group allows you to turn off autoanalysis, change the samples and folder naming options, the location where they are placed, and the owner of the Results Group.
3. You can change the Analysis Protocol to experiment with different ways of analyzing the sample, using a different basecaller for example.
4. Check the check box in the Extract column for the samples you wish to extract again.
5. Click **Extract**.

Note: Reextraction creates an entirely new sample file and does not replace the previously saved sample file. The presence of a previous sample file has no effect on the creation of a new sample file. If the same naming options that are used for reextraction are identical to those used previously, a number is appended to the filename. For example, if the first sample is, “sample 01.ab1” then the second sample would be, “sample 01 (1).ab1.”

Notes _____



Viewing Analyzed Data

Locating Sample Files

Analyzed sample files are extracted into a run folder defined in the Naming tab of your Results Group, and placed in a location defined in the Destination tab.

The default location is:

E:\AppliedBiosystems\UDC\DataCollection\Data\ <instrument type>\<instrument name>\<Run Name>

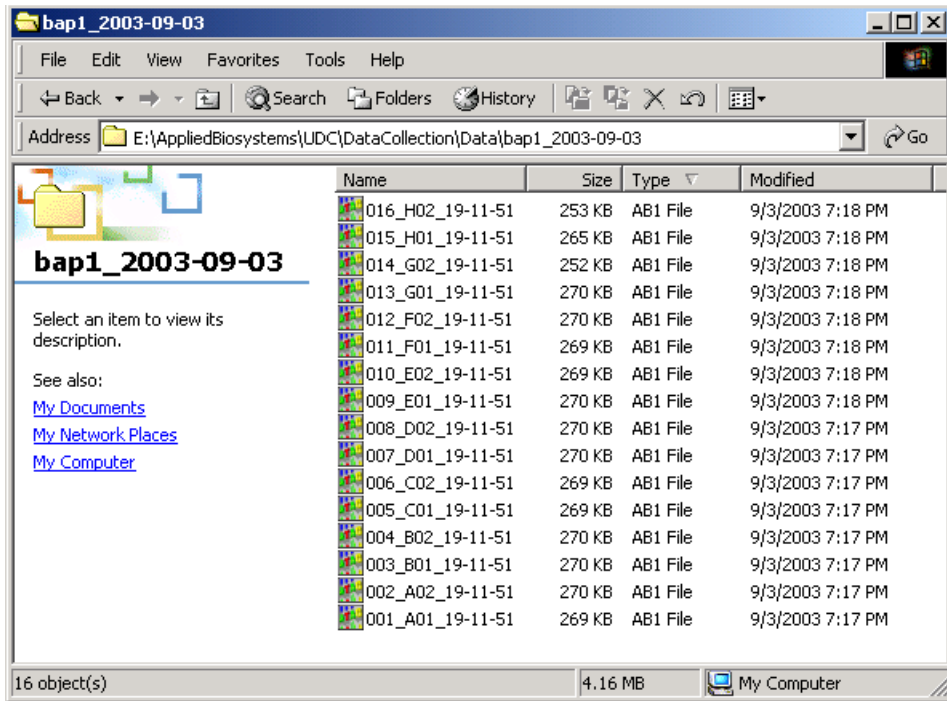

Locating Sample Files

Locate the reextracted data in the location defined by the Results Group or the default destination location.

Viewing Sample Files

Use the Sequencing Analysis, SeqScope, or the GeneMapper Software to view re-extracted sample electropherogram data, both raw, and analyzed.

Sample file type	File extension
Sequencing, SeqScope	.ab1
Fragment analysis	.fsa

Notes _____

Plate Mapping

Injection Scheduling

Samples are scheduled for injection based on their position in a 96- or 384-well plate and the capillary number. Study the appropriate plate mapping patterns described in “[96-Well Plate Mapping](#)” or “[384-Well Plate Mapping](#)” to arrange your samples according to your preferred injection priority.

The injection schedule system is based on the:

- Order of the linked plates (3130*xl* instrument only). See [page 114](#) for linking plate information.
- Sample priority value in the plate record.

If all priorities are set to 100 (default), then runs are scheduled as outlined below. See the *Applied Biosystems 3130/3130*xl* Genetic Analyzers Maintenance, Troubleshooting, and Reference Guide* (Part no. 4477854) on “Run Priority Scheduling”.

Capillary Array Map

The capillary numbers in the capillary array are shown in the layout below. The capillary array layout is the same for both 96- and 384-well plates.

Capillary Number Layout

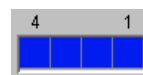
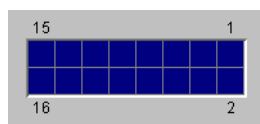

Notes _____

96-Well Plate Mapping

3130x/ Genetic Analyzer

For a 96-well plate, injections are made from every well in two consecutive rows, starting with an odd row. A full 96-well plate requires six runs to inject all samples. See the examples below where samples (grey) and capillary number (number) positions can affect your number of runs.

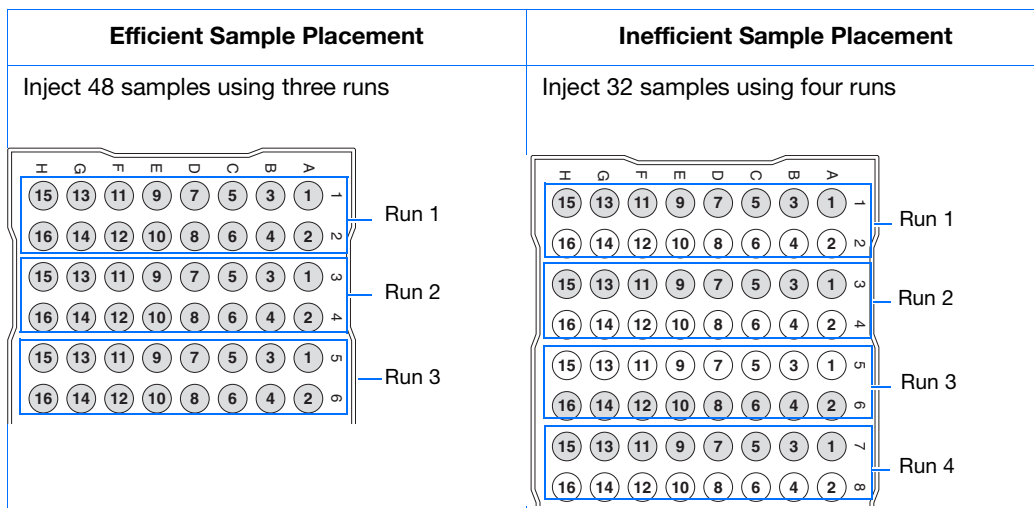

3130 Genetic Analyzer

For a 96-well plate, injections are made from four consecutive wells in a row. A full plate of 96 sample requires 24 runs to inject all samples once.

In the following example of a 96-well plate, the gray circles represent samples and the number in the well indicates capillary number. It takes four runs to inject 16 samples.

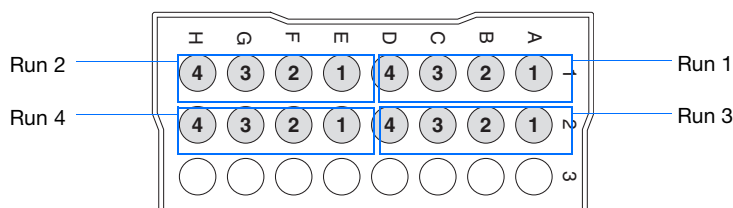

Notes _____

384-Well Plate Mapping

3130x/ Genetic Analyzer

For a 384-well plate, injections are made from every other well and every other row. A full plate of 384 samples requires 24 runs to inject all samples once.

The example below is the injection pattern for the first four injections, starting with well A01. The light gray circles represent samples and the dark gray circles indicate the injection pattern.

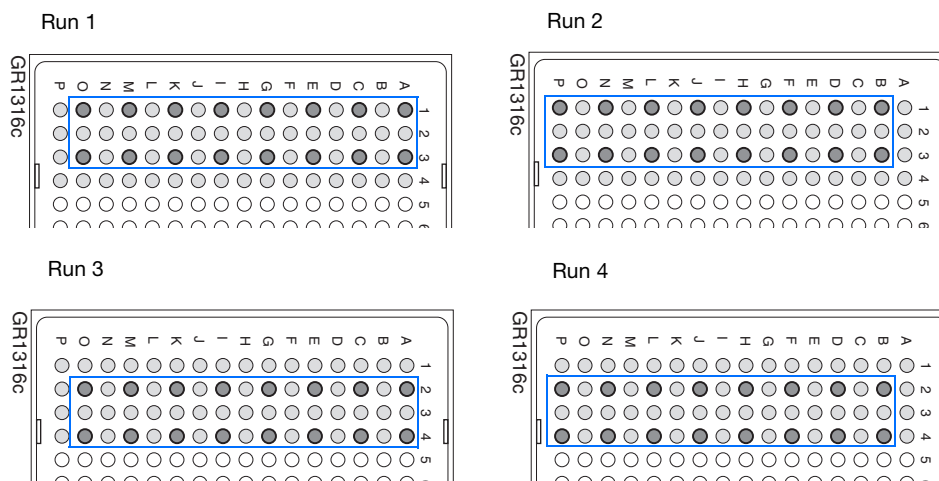

3130 Genetic Analyzer

For a 384-well plate, injections are made from every other well. A full plate of 384 sample requires 96 runs to inject all samples once.

The example below is the injection pattern for the first six injections, starting with well A01. The light gray circles represent samples and the dark gray circles indicate the injection pattern.

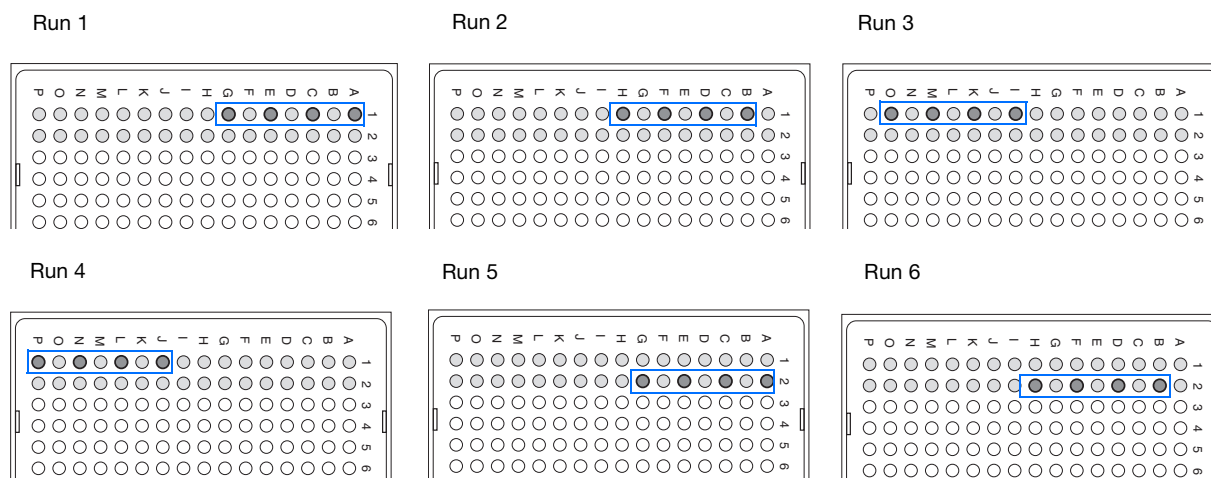

Notes _____

Notes _____

KB™ Basecaller Software v1.4.1

Executive Summary	145
Benefits of using the KB™ Basecaller	146
Future support of ABI and KB™ Basecallers	149
Features in KB™ Basecaller Software v1.4.1	149
Differences between the ABI and KB™ Basecallers.....	151
Differences between the ABI and KB™ Basecallers.....	151
FAQs: Processing data with Phred software and .phd.1 Files	154
FAQs: Quality values.....	155
Miscellaneous FAQs	157
Conference posters and reference	158

Executive Summary

Applied Biosystems® KB™ Basecaller Software v1.4.1 reduces manual data review time and increases the read length of high-quality bases in sequences. This algorithm accurately extracts more bases out of the sequencing data generated on Applied Biosystems® DNA Analyzers and Genetic Analyzer Instrument and chemistry platforms. KB™ Basecaller Software v1.4.1 supports all BigDye® Terminator v3.1 and v1.1 and BigDye® Direct chemistries and run modules available on Applied Biosystems® instruments.

- 310 Genetic Analyzer
- 3100/3100-*Avant* Genetic Analyzers
- 3130/3130*xl* Genetic Analyzers
- 3730/3730*xl* DNA Analyzers
- 3500 Dx and 3500 Dx/3500xL Dx Genetic Analyzers
- 3500 and 3500/3500xL Genetic Analyzers.

Software integration

KB™ Basecaller Software v1.4.1 is integrated with:

- Sequencing Analysis Software 6 and v5.4
- SeqScape® Software 3 and v2.7
- Variant Reporter® Software 2 and v1.1

Notes

- 3130 Series and 3730 Series Data Collection Software 4
- 3500 Series Data Collection Software
- MicroSEQ® ID Analysis Software v2.2

KB™ Basecaller Software v1.4.1 is *not* integrated with:

- MicroSeq® ID software versions 2.1 and older
- Any versions of Data Collection Software for the 310 and 3100/3100-*Avant*
- 3130/3130*xl* and 3730/3730*xl* Data Collection Software versions before v3.1
- Sequencing Analysis Software before v5.4
- SeqScape® Software versions before v2.7
- Variant Reporter® Software versions before v1.1.

During the co-installation of Sequencing Analysis Software 6 and SeqScape® Software 3 with Data Collection Software 4, KB™ Basecaller Software v1.4.1 is installed into your Data Collection Software 4 on the same computer.

Testing on more than 50,000 sequencing samples shows that version 1.4.1 of the algorithm offers many advantages, including longer, accurate read lengths.

Details of the test and validation process are in the poster *Longer Reads and More Robust Assemblies with the KB™ Basecaller*.

IMPORTANT! Applied Biosystems strongly recommends using the KB™ Basecaller.

Benefits of using the KB™ Basecaller

Some benefits of using the KB™ Basecaller include:

- Increased length of read
- Per-base quality value predictions using an equation that is standardized by Phred software
- Optional detection of mixed-base with quality values
- Analysis of short PCR products
- Accurate start point detection
- Increased accuracy in regions of low signal-to-noise or anomalous signal artifacts
- Detection of failed samples
- Trimming of data using per-base quality value
- Per-sample quality value that helps to determine the quality of each read
- Optional detection of PCR stop
- Optional assignment of Ns
- Optional generation of .phd.1 files

Notes _____

Increased length of read	KB™ Basecaller accurately extracts more bases than ABI Basecaller from the 3' and 5' ends of a sequence. Tests on genomic BAC samples, performed on data generated using 3730/3730xl instruments, indicate an improvement of approximately 100 bases in length-of-read as compared to the same data analyzed by the ABI Basecaller and Phred software (v0.020425.c). The gain in read length varies depending on the run module used to collect the data. The accuracy of start point estimation and the first 50 bases of called sequence is substantially increased. Typically, ~10 more correct calls on average are identified at the 5' end as compared to the ABI Basecaller.
Per-base quality value predictions	<p>The KB™ Basecaller assigns quality values to every basecall. The quality prediction algorithm is calibrated to return Q values that conform to the industry-standard relation established by the Phred software. The KB™ Basecaller and its output are, therefore, interchangeable in processes requiring Phred software for output.</p> <p>Quality value calibration was performed using a set of correct-sequence annotated sample files, representative of production sequencing data generated on capillary electrophoresis platforms. Over 52.1 million basecalls were used to calibrate KB™ Basecaller Quality Values and over 32.9 million distinct basecalls were used to test the calibration.</p>
Accuracy in start point detection	Improved start point detection contributes to better mobility shift corrections and greater basecalling accuracy in the first 50 bases. Because the KB™ Basecaller detects the start point accurately, you do not need to manually set start points for each sample.
Optional detection of mixed-base with quality values	<p>The KB™ Basecaller can detect mixed base positions, and assign two-base (R, Y, K, M, S, W) IUB codes and quality values to those positions. Quality values are assigned to mixed basecalls using an algorithm similar to that for pure bases.</p> <p>The definition conforms to the Phred relation. Quality values for mixed bases are inherently lower than those of pure bases due to the higher error risk of interpreting more complex signals. Note that when using the ABI Basecaller or ABI Basecaller and Phred software, a separate analysis stage is required to determine mixed bases.</p>
Increased accuracy in regions of low signal-to-noise or anomalous signal artifacts	<p>The KB™ Basecaller increases the accuracy of sequence reads from low-signal regions or from data that are partially contaminated by a secondary sequence or by other sources of “chemistry noise”.</p> <p>Basecalling errors caused by anomalous chemistry and/or instrument signals such as dye blobs and fluorescent spikes are substantially reduced. These artifacts often occur in otherwise high-quality “clear-range” data. They result in the loss of high-quality bases that are downstream from the noise region. Tests indicate that KB™ Basecaller distinguishes between target DNA peaks and the most common artifacts better than ABI Basecaller.</p>
Analysis of short PCR products	The KB™ Basecaller has been tested for accuracy in basecalling and quality value estimates on PCR products as short as 100 bases. Although KB™ Basecaller may be able to basecall products with less than 100 bases, these types of sample files were not tested.

Notes

Detection of failed samples

The KB™ Basecaller indicates the gross sample quality of each analysis as “Success without warnings,” “Success with warnings,” or “Failure due to poor data quality”. A common failure mode is no signal—insufficient detection of DNA peaks. For failed samples, the KB™ Basecaller uses “NNNNN” as the sequence, indicating that the sample quality is very low and may need to be omitted from further analysis. Failed samples are flagged in reports in the analysis software. Note that this behavior is different from the ABI Basecaller, which *always* tries to call bases, resulting in sequences of many Ns.

Option to trim data using per-base quality value

You can use software with KB™ Basecaller to automatically determine the clear range region by trimming the ends using the per-base quality values. The parameters used for trimming are similar to those in other tools used by the genome community.

Per-sample quality value (QV) evaluates quality of reads

Software with the KB™ Basecaller uses the QV from the KB™ Basecaller to trim and determine a sample score. The sample score is the average QV in the clear range, or, if no clear range is determined, in the entire read. This single number value is a measure of the quality of the data. The sample score appears in reports generated by Sequencing Analysis Software, SeqScape® Software, Sequence Scanner Software, Variant Reporter® Software, and/or MicroSeq® ID Software.

Optional detection of PCR stop

You can set the KB™ Basecaller to end basecalling at a PCR stop. Note that samples with enzymatic failure may have signal properties similar to those in PCR stop conditions. The KB Basecaller may not be able to distinguish between these two conditions.

Optional assignment of Ns

By default, the KB™ Basecaller does not generate Ns. However, you may choose to reassign Ns to bases with QVs below a user-specified threshold for both pure and mixed base positions.

Optional generation of .phd.1 files

.phd.1 files can be generated by autoanalysis or in analysis software. You can use the .phd.1 files for further analysis by downstream software such as Phred software.

Notes _____

Future support of ABI and KB™ Basecallers

Applied Biosystems will continue to provide technical support for the ABI Basecaller. However, further development and defect fixes will occur only on the KB™ Basecaller. If you encounter a defect in the ABI Basecaller, please use the KB™ Basecaller instead. In future releases, ABI Basecaller support files are removed from the software wherever they duplicate support in the KB™ Basecaller.

Features in KB™ Basecaller Software v1.4.1

- A basecalling algorithm that supports Applied Biosystems® 310, 3100/3100-*Avant*, 3130/3130*xl*, 3730/3730*xl*, 3500/3500xL, and 3500 Dx/3500xL Dx Genetic Analyzers
- Improvements over all earlier versions of KB™ Basecaller (v1.0, v1.1, v1.1.1, v1.1.2, v1.2, v1.3, and v1.4)

Note: Basecalling results with KB™ Basecaller Software v1.4.1 may differ slightly from results obtained with previous versions of KB™ Basecaller.

Notes _____

Comparison of the ABI and KB™ Basecallers

Question	ABI Basecaller	KB™ Basecaller
What does the software do?	<ul style="list-style-type: none"> Processes raw traces Provides processed traces Provides AGCTN calls 	<ul style="list-style-type: none"> Processes raw traces Provides processed traces Provides pure bases only <i>or</i> Provides pure and mixed calls Provides quality values Generates .phd.1 and .scf files Provides a sample score
What are the resulting basecalls?	<p>One option available: Only mixed bases are assigned as Ns. Further processing (either manual or using additional software) is required to assign IUB codes to the Ns or pure bases.</p>	<p>Four options are available. The software can assign an:</p> <ul style="list-style-type: none"> ACGT and Q value to each peak. ACGT and Q value to each peak. Any peak with a Q value below a defined threshold is reassigned an N. ACGT or a mixed base and a Q value to each peak. ACGT or a mixed base and a Q value to each peak. Any peak with a Q value below a defined threshold is reassigned an N.
How are failed samples handled (for example, no signals, chemistry failure)?	Attempts to call all bases so a sample results with many Ns.	Assigns five Ns to the entire sample to indicate that the sample failed analysis. The analysis report flags these files.
Baseline in processed data	Appears smoother than in KB™ Basecaller.	Appears less smooth than in ABI KB™ Basecaller.
What are the steps to process data?	Calls bases on Windows OS.	Calls bases and estimates QVs on Windows OS.
Data and future support	<p>Supports the 310, 3100, 3100-<i>Avant</i>, Applied Biosystems® 3130/3130<i>xl</i> and 3730/3730<i>xl</i> instruments.</p> <p>Further development has stopped.</p>	<p>Applied Biosystems® 310, 3100/3100-<i>Avant</i>, 3130/3130<i>xl</i>, 3730/3730<i>xl</i>, 3500/3500<i>xL</i>, and 3500 Dx/3500<i>xL</i> Dx Genetic Analyzers.</p> <p>Development is ongoing.</p>

Notes _____

Differences between the ABI and KB™ Basecallers

Question	Answer	
	ABI Basecaller	KB™ Basecaller
Can the KB™ Basecaller basecall short PCR products?		The KB™ Basecaller has been tested for accuracy in basecalling and quality value estimation on PCR products as short as 100 bases. Although it may be possible to basecall products with less than 100 bases, such sample files have not been tested. Samples shorter than 100 bases may not contain enough signal information to basecall the sample file.
Why is the baseline less smooth when the data are analyzed with the KB™ Basecaller?	<p>Processed signals or traces from the ABI Basecaller appear smoother than those from the KB™ Basecaller because each software application uses an algorithm that processes the signals differently.</p> <p>The ABI Basecaller assigns only AGCT and Ns to each peak. Therefore, you must manually search for mixed bases or use a secondary software to complete the task. To facilitate this secondary process, the ABI Basecaller subtracts an aggressive baseline estimate to show a cleaner baseline in the processed signals.</p>	The KB™ Basecaller can determine pure and mixed bases. Therefore, second-stage processing, which allows less aggressive baseline subtraction, is not needed. The processed traces have a higher baseline. If you have mixed bases, turn on the mixed-base detection option and allow KB™ Basecaller to call mixed bases. Use the mixed base calls and the associated QVs to review mixed bases – do not look only at the baseline.
What is the signal to noise value found with data analyzed with the KB™ Basecaller?	<p>The signal-to-noise value is the average of the signal intensity of the A, C, G, or T base divided by the average of the noise for that base.</p> <p>The ABI Basecaller calculates only the signal intensity. The signal-to-noise value is more indicative of data quality than the signal intensity value alone. Both properties are important in determining quality.</p>	KB™ Basecaller calculates the information and presents the data in the Annotation view and analysis report.

Notes _____

Appendix B

Differences between the ABI and KB™ Basecallers

Question	Answer	
	ABI Basecaller	KB™ Basecaller
What scaling options are available with the KB™ Basecaller?	The ABI Basecaller uses a scaling method closer to the “True profile” option than the “Flat profile” option.	<p>The KB™ Basecaller can display scaled data in two ways:</p> <ul style="list-style-type: none"> • True profile scaling With this method, the processed traces are scaled uniformly so that the average height of peaks in the region of strongest signal is about equal to a fixed value (for example, 1000). The profile of the processed traces is very similar to that of the raw traces. • Flat profile scaling The processed traces are scaled semi-locally so that the average height of peaks in any region is about equal to a fixed value (for example, 1000). The profile of the processed traces is flat on an intermediate scale (> about 40 bases). <p>You must decide which option is better suited to your circumstances. The sequence and QVs called by the KB™ Basecaller are independent of the selected scaling option.</p>
Does the KB™ Basecaller produce more usable sample files than the ABI Basecaller?		<p>Tests show that medium- and high-quality data result in more usable bases (longer read length) when analyzed by the KB™ Basecaller than by the ABI Basecaller.</p> <p>For very poor-quality data (samples with no, low, or noisy signal), the KB™ Basecaller does not provide more bases but instead fails the samples. By calling a string of “NNNNN” for the failed samples (instead of a sequence containing low QVs), the KB™ Basecaller indicates that the sample is unusable.</p>
Can the KB™ Basecaller analyze data generated on the ABI PRISM® 373, 377, or 3700 instruments?		<p>No, the KB™ Basecaller is calibrated to basecall and estimate the basecall quality for BigDye® Terminator chemistries on 310, 3100, 3100-Avant, and 3130/3130xI Genetic Analyzers, 3730/3730xI DNA Analyzers, and 3500/3500xL and 3500/3500 Dx/3500xL Dx Genetic Analyzers. Applied Biosystems has stopped support for the 373, 377, and 3700 instruments and data analysis.</p>

Notes _____

Question	Answer	
	ABI Basecaller	KB™ Basecaller
How can I determine which basecaller was used to analyze each sample file?		The Annotation view for each sample file and for the print header displays the basecaller name and version number. When displaying samples files, files analyzed by the KB™ Basecaller have QV value bars displayed above the electropherogram.
Are there any known incompatibilities when a sample file is analyzed with the KB™ Basecaller?		Applied Biosystems does not know of any incompatibility issues when a sample file (.ab1) is analyzed with the KB™ Basecaller and used in third-party software.

Notes _____

FAQs: Processing data with Phred software and .phd.1 Files

Question	Answer
<p>Can I analyze sample files with the KB™ Basecaller and then reprocess them with Phred software?</p>	<p>In principle, yes, but this is not recommended. The resulting quality values from Phred software are not calibrated—i.e., it is possible that Phred will over or under-predict quality in certain circumstances because it has not been trained on the type of processed electropherogram produced by the KB™ Basecaller. (Phred has been trained using the ABI Basecaller to produce the processed traces.)</p> <p>In addition, Phred replaces (and ignores) the initial called sequence. Reprocessing KB-analyzed samples with Phred, on average, degrades the accuracy of the analysis in terms of actual sequence error. Analysis improvements in KB™ Basecaller outlined above are lost.</p> <p>Studies by Applied Biosystems indicate that running Phred software on sample files processed by the KB™ Basecaller degrades the quality of the results.</p> <p>Analysis with KB™ Basecaller can generate .phd.1 files, which are interchangeable with any processes that currently depend on Phred.</p>
<p>Which Applied Biosystems® software generates .phd.1 files?</p>	<p>The following software products have KB™ Basecaller (version varies for each software) integrated and can generate .phd.1 files:</p> <ul style="list-style-type: none"> • ABI PRISM® 3100-<i>Avant</i> Data Collection Software v2.0 • ABI PRISM® 3100 Data Collection Software v2.0 • Applied Biosystems® 3130/x/ and 3730/x/ Data Collection Software v3.0 and later • Sequencing Analysis Software v5.2 and later • SeqScape® Software v2.5 and later • MicroSeq® ID Software v1.0 and later • Variant Reporter® Software v1.0 and later

Notes _____

FAQs: Quality values

Question	Answer
How do I use quality values to review data?	<p>When analyzing data with pure bases, Applied Biosystems Corporation recommends that you use the following settings:</p> <p>Pure bases – Low QV = <15, Medium QV= 15–19, High QV= 20+ (default)</p> <p>When reviewing data with pure bases, use the QVs to briefly review bases with high QV(>20). Pay close attention to bases with medium QVs because you may need to make edits. Quickly review low-QV bases, although you will likely discard these bases from further analysis.</p> <p>Mixed base quality values will be lower than pure bases. For mixed bases, review all mixed basecalls. You may want to accept basecalls with quality values as low as 1.</p> <p>Mixed bases – Low QV = <5, Medium QV = 5–10 (investigate to determine the best range for your application)</p> <p>In all cases, keep in mind that, by definition, the predicted probability of error for a particular basecall is $10^{-q/10}$.</p>
What are the differences between quality values of mixed bases and pure bases?	<p>Pure bases and mixed bases have the same probability of error for the associated basecall ($10^{-q/10}$). Note the following:</p> <ul style="list-style-type: none"> • High-quality pure bases typically have QVs of 20 or higher. • The distribution of quality values for mixed bases differs dramatically from that of pure bases. • For mixed bases, quality values greater than 20 are rare. • Accurate mixed basecalls may be assigned quality values as low as 1, because the probability of error with mixed bases is higher. Review all mixed basecalls.
Can I trim my data using quality values?	<p>Yes. When using Data Collection, you can set trimming using QVs in the analysis protocols.</p> <p>When using Sequencing Analysis Software, SeqScape® Software, MicroSeq® ID Software or Variant Reporter® Software, you can set trimming using QVs in the Analysis settings.</p>

Notes _____

Question	Answer																																				
<p>Is there a table that shows each quality value and its corresponding probability of error?</p>	<p>The following table shows each quality value and its corresponding probability of error. For a more extensive table, look in the Help menu or the Sequencing Analysis Software or the SeqScape® Software user guides.</p> <table border="1" data-bbox="654 422 1393 814"> <thead> <tr> <th>QV</th> <th>Pe</th> <th>QV</th> <th>Pe</th> </tr> </thead> <tbody> <tr> <td>1</td> <td>79.0%</td> <td>35</td> <td>0.032%</td> </tr> <tr> <td>5</td> <td>32/0%</td> <td>40</td> <td>0.010%</td> </tr> <tr> <td>10</td> <td>10.0%</td> <td>41</td> <td>0.0079%</td> </tr> <tr> <td>15</td> <td>3.2%</td> <td>45</td> <td>0.0032%</td> </tr> <tr> <td>20</td> <td>1.0%</td> <td>50</td> <td>0.0010%</td> </tr> <tr> <td>21</td> <td>0.79%</td> <td>60</td> <td>0.00010%</td> </tr> <tr> <td>25</td> <td>0.32%</td> <td>99</td> <td>0.00000000013%</td> </tr> <tr> <td>30</td> <td>0.10%</td> <td></td> <td>-</td> </tr> </tbody> </table>	QV	Pe	QV	Pe	1	79.0%	35	0.032%	5	32/0%	40	0.010%	10	10.0%	41	0.0079%	15	3.2%	45	0.0032%	20	1.0%	50	0.0010%	21	0.79%	60	0.00010%	25	0.32%	99	0.00000000013%	30	0.10%		-
QV	Pe	QV	Pe																																		
1	79.0%	35	0.032%																																		
5	32/0%	40	0.010%																																		
10	10.0%	41	0.0079%																																		
15	3.2%	45	0.0032%																																		
20	1.0%	50	0.0010%																																		
21	0.79%	60	0.00010%																																		
25	0.32%	99	0.00000000013%																																		
30	0.10%		-																																		
<p>Where can I see quality value bars and numbers?</p>	<p>Sequencing Analysis Software, SeqScape® Software, MicroSeq® ID Software, and Variant Reporter® Software allow you to display or hide quality value (QV) bars in displays and printouts. You can customize the color and range for low, medium, and high quality values. For QVs ≤ 50, the length of a bar is proportional to the corresponding quality value. Quality values above 50 will have the same color and QV bar length as those defined for a QV of 50. To see the quality value for a particular base, place the computer mouse over the QV bar.</p> <p>In SeqScape® Software, MicroSeq® ID Software, and Variant Reporter® Software, the per-base quality values also appear in the reports corresponding to bases identified as mutations.</p>																																				
<p>Why are the quality value bars displayed in gray?</p>	<p>A quality value is assigned to a specific basecall. When you change a basecall, the quality value does not apply to the new base, and therefore, it is displayed as a gray bar.</p> <p>Also when you reassign Ns to bases below a certain QV, the QV bar does not apply to the N basecall, and therefore it is displayed as a gray bar.</p>																																				
<p>Are quality value bars printed for the Electropherogram or Sequence views?</p>	<p>You can show or hide the QV bars when printing the Electropherogram and Sequence views of the sample file. QV bars are not printed if you print more than seven panels per page (due to space limitations). The quality value numbers cannot be printed.</p>																																				
<p>Which Applied Biosystems software can display the quality values?</p>	<p>Sequencing Analysis Software v5.X, Sequencing Analysis Software 6, SeqScape® Software v2.X, SeqScape® Software 3, MicroSeq® ID Software v1.X, v2.X, Variant Reporter® Software v1.X, and Variant Reporter® 2 can display quality values.</p>																																				
<p>Can I view quality values from KB™ Basecaller with other software?</p>	<p>Quality value graphics from KB™ Basecaller are customized for processing by other Applied Biosystems software. The KB™ Basecaller allows other Applied Biosystems software to perform additional functions, such as clear range trimming and more streamlined editing.</p>																																				

Notes

Miscellaneous FAQs

Some frequently asked questions regarding Ns, spacing values, and providing feedback are shown below.

Question	Answer
When do Ns appear in samples analyzed by the KB™ Basecaller Software?	<p>When using the KB™ Basecaller, the sequence “NNNNN” appears in the sample file when the sample fails analysis. Omit this file from further analysis. The Analysis Report in Sequencing Analysis Software will also flag these files.</p> <p>In addition to pure and mixed bases shown with QV bars, N's and gray QV bars are also shown when you reassign Ns to all bases before the user-specified QV threshold. This allows you to view the longer read length and more accurate basecalling of KB™ Basecaller while still viewing data with software that does not display QVs.</p>
Why does the spacing value sometimes appear in red?	When the ABI Basecaller fails to determine a spacing value for a sample file, it uses a default value of 12.00 for all run conditions. This number appears as in red in the Sample Manager, and the Annotation view displays “-12.00”.
Why does the spacing value sometimes have a negative value?	When the KB™ Basecaller fails to determine a spacing value for a sample file, it uses a default value specific to the instrument/polymer/chemistry/run condition used to generate the sample file. This value appears in red in the Sample Manager. The Annotation view displays -1 times this value.
How can I provide feedback to the KB™ Basecaller product team?	Email information to your local Life Technologies applications support representative at www.lifetechnologies.com/support . If applicable, please include sample files and details (including analysis settings) on how to reproduce your observation.

Notes _____

Conference posters and reference

- Posters**
- ABRF 2007 – *Improved Accuracy for Mutation and SNP Detection: Variant Reporter[®] Software*, Ming Li, *et al.*
 - ESHG 2007 – Direct Sequencing Quality Control
 - AGBT 2004 – Longer Reads with the KB[™] Basecaller
 - ABRF 2004 – Integrated Sequencing Analysis Solutions using the KB[™] Basecaller from Applied Biosystems
 - ESHG 2009 Performance of the KB[™] Basecaller for a New Sequencing System

These posters and other literature can be found at:

www.lifetechnologies.com

Click **Support**, then **Products and Technical Literature**. Search with the keyword *KB*.

- Reference** B. Ewing and P. Green, *Genome Research*, 8:186–194, 199.

Notes _____

Managing Software License for 3130 Series Data Collection Software 4

Manage software licenses

The 3130 Series Data Collection Software 4 requires a license to run.

IMPORTANT! If you replace or add a network card in the computer running the software, or relocate the software to a new computer, contact Life Technologies to update your license for the new network card or computer.

Obtain and activate a software license

The 3130 Series Data Collection Software 4 Software Activation dialog box is displayed when you start the software if no license is installed and activated on your computer.

This task is typically performed by the Life Technologies service representative during installation of the instrument.

1. Ensure that all network cards in the computer are enabled.

IMPORTANT! You can run the 3130 Series Data Collection Software 4 using only the network cards enabled when you activate the software license. For example, if you activate the software when your wireless network card is disabled, you will not be able to run the software when the wireless network card is enabled.

Notes _____

Appendix C

Obtain and activate a software license

2. Display the Software Activation dialog box by starting the 3130 Series Data Collection Software 4.

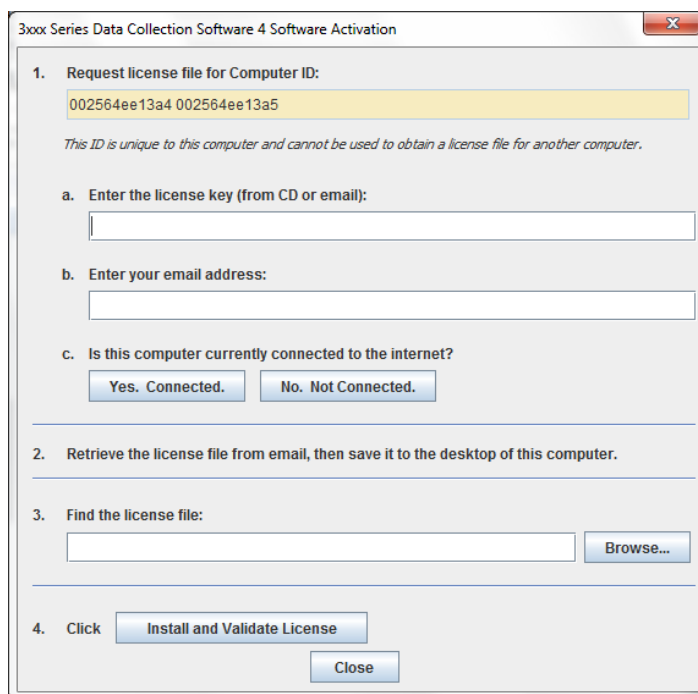

3. Obtain the license key. The license key is provided on the 3130 Series Data Collection Software 4 CD case, or in an email from Life Technologies.
4. Request the software license file by performing steps **1a**, **1b**, and **1c** as listed on the activation screen.

IMPORTANT! Keep a record of the email address used to activate the software license. You must use the same email address to renew the software license when it expires.

5. Obtain the software license file from your email.
6. Make a copy of the software license file and keep in a safe location.
7. Copy the software license file to the desktop of the 3130 Series Data Collection Software 4 computer.

Notes _____

8. If the Software Activation dialog box has closed, start the 3130 Series Data Collection Software 4 to open it.
9. Click **Browse**, then navigate to the software license file saved on your computer.
10. Click **Install and Validate License**. A message is displayed when the license is installed and validated.
11. Click **Close**.

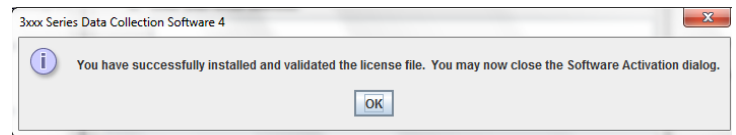

Renew a software license

1. Ensure that all network cards in the computer are enabled.
2. Display the Software License Renewal dialog box by doing either of the following:
 - Select **Activate License Now** in the Warning: License Will Expire Soon dialog box that is displayed 8–30 days prior to expiration.

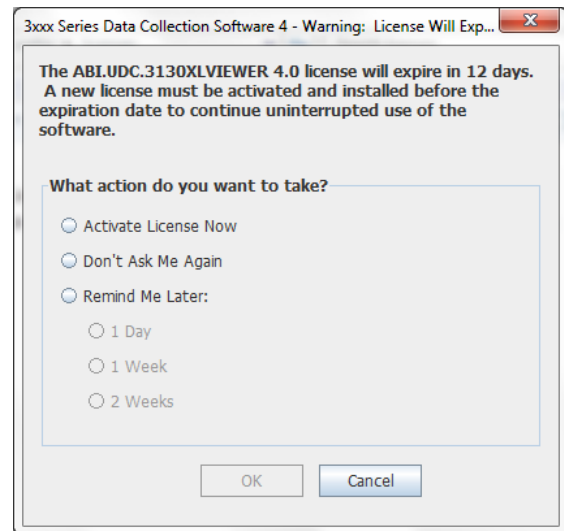

- Click **Yes** in the Critical Warning: License Will Expire Soon dialog box that is displayed within 7 days of expiration.

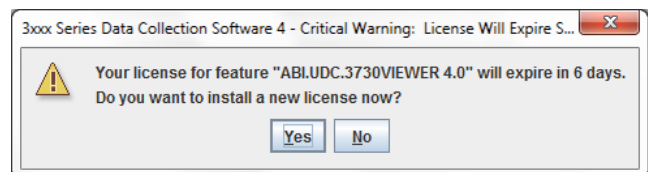

Notes _____

Appendix C

Renew a software license

3. Choose **Activate/Install License Now** to display page shown at right. Click **Reinstall License** in the lower-left corner.

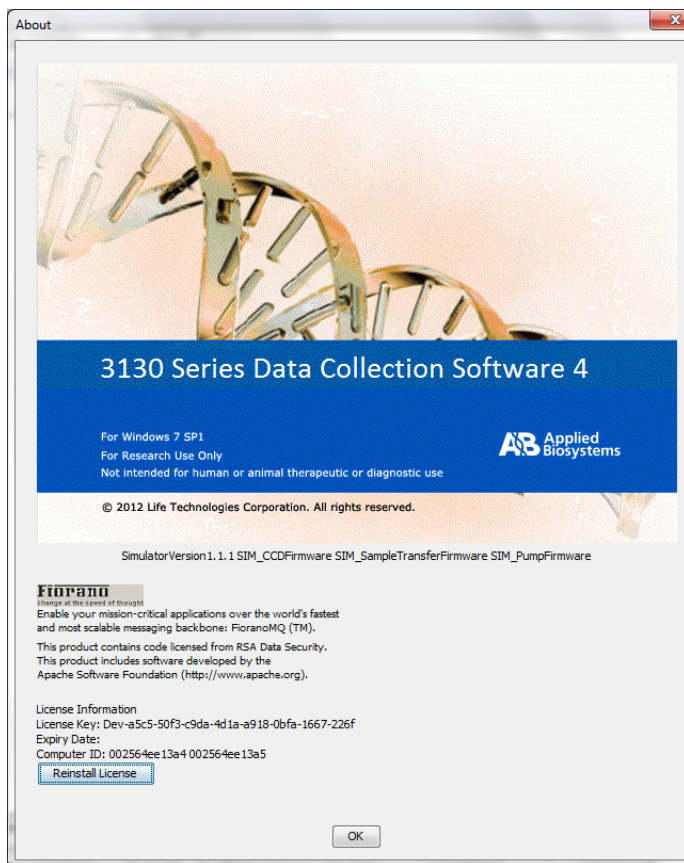

Notes _____

4. Complete the License Renewal dialog box as described below:

5. Enter the email address used to activate the software license.

IMPORTANT! You must use the same email address to activate and renew the software license. If you do not have the activation email address available, enter any email address, click the licensing link in the Software Renewal dialog box, then click **Contact Support** in the License Renewal web page displayed.

6. Request the renewed software license file by performing step **1c** as listed on the renewal screen.

7. Obtain the renewed software license file from your email.

8. Copy the renewed software license file to the desktop of this computer.

9. Click **Browse**, then navigate to the renewed software license file saved on your computer.

10. Click **Install and Validate License**. A message is displayed when the license is installed and validated.

11. Click **Close**.

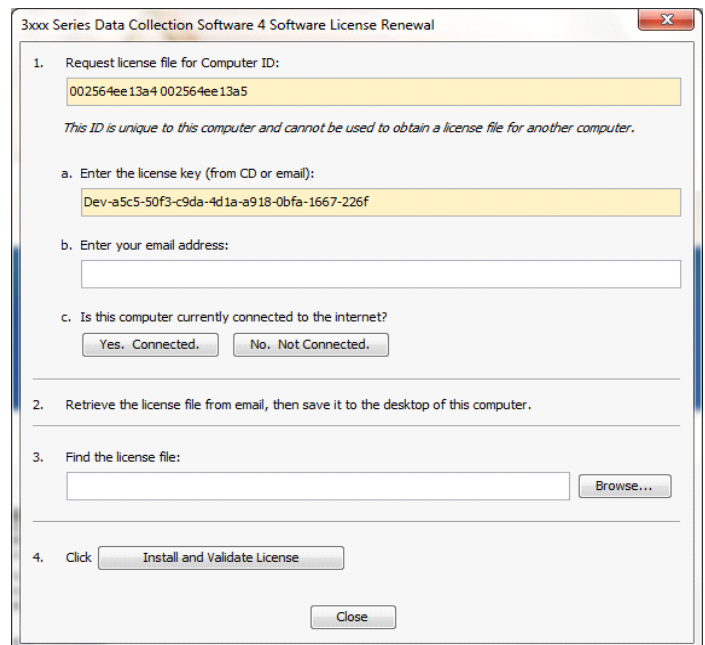

Notes _____

Notes _____



WARNING

GENERAL SAFETY. Using this product in a manner not specified in the user documentation may result in personal injury or damage to the instrument or device. Ensure that anyone using this product has received instructions in general safety practices for laboratories and the safety information provided in this document.











- Before using an instrument or device, read and understand the safety information provided in the user documentation provided by the manufacturer of the instrument or device.
- Before handling chemicals, read and understand all applicable Safety Data Sheets (SDSs) and use appropriate personal protective equipment (gloves, gowns, eye protection, etc). To obtain SDSs, see [“Obtaining Support” on page 177](#)”.
- All testing should be performed in accordance with local, regional and national acceptable laboratory accreditation standards and/or regulations.

Symbols on instruments

Symbols may be found on the instrument to warn against potential hazards or convey important safety information. In this document, the hazard symbol is used along with one of the following user attention words described:

- **CAUTION!** – Indicates a potentially hazardous situation that, if not avoided, may result in minor or moderate injury. It may also be used to alert against unsafe practices.
- **WARNING!** – Indicates a potentially hazardous situation that, if not avoided, could result in death or serious injury.
- **DANGER!** – Indicates an imminently hazardous situation that, if not avoided, will result in death or serious injury.

Symbol	English	Français
	Caution, risk of danger Consult the manual for further safety information.	Attention, risque de danger Consulter le manuel pour d'autres renseignements de sécurité.
	Caution, hot surface	Attention, surface chaude
	Caution, risk of electrical shock	Attention, risque de choc électrique
	Laser radiation	Rayonnement laser
	Caution, piercing hazard	Attention, danger de perforation

Symbol	English	Français
	Potential biohazard	Danger biologique potentiel
	Ultraviolet light	Rayonnement ultraviolet
	On	On (marche)
	Off	Off (arrêt)
	On/Off	On/Off (marche/arrêt)
	Protective conductor terminal (main ground)	Borne de conducteur de protection (mise à la terre principale)
	Terminal that can receive or supply alternating current or voltage	Borne pouvant recevoir ou envoyer une tension ou un courant de type alternatif
	Terminal that can receive or supply alternating or direct current or voltage	Borne pouvant recevoir ou envoyer une tension ou un courant continu ou alternatif
	<p>Do not dispose of this product in unsorted municipal waste. Follow local municipal waste ordinances for proper disposal provisions to reduce the environmental impact of waste electrical and electronic equipment</p> <p> CAUTION To minimize negative environmental impact from disposal of electronic waste, do not dispose of electronic waste in unsorted municipal waste. Follow local municipal waste ordinances for proper disposal provision and contact customer service for information about responsible disposal options.</p>	<p>Ne pas éliminer ce produit avec les déchets usuels non soumis au tri</p> <p> CAUTION Pour minimiser les conséquences négatives sur l'environnement à la suite de l'élimination de déchets électroniques, ne pas éliminer ce déchet électronique avec les déchets usuels non soumis au tri sélectif. Se conformer aux ordonnances locales sur les déchets municipaux pour les dispositions d'élimination et communiquer avec le service à la clientèle pour des renseignements sur les options d'élimination responsable.</p>

Conformity mark	Description
	Indicates conformity with safety requirements for Canada and U.S.A.

Safety alerts on this instrument

The following table shows the location of safety alerts found on the instrument. See [“Symbols on instruments” on page 165](#) for more information.

English	French translation	Location on Instrument
 <p>Class 3B (III) visible and/or invisible laser radiation present when open and interlocks defeated. Avoid exposure to beam.</p>	<p>DANGER! Rayonnement laser visible ou invisible de classe 3B (III) présent en position ouverte et avec les dispositifs de sécurité non enclenchés. Éviter toute exposition au faisceau.</p>	<p>Detection cell cover</p> 

Instrument safety

General

 **CAUTION** **Do not remove instrument protective covers.** If you remove the protective instrument panels or disable interlock devices, you may be exposed to serious hazards including, but not limited to, severe electrical shock, laser exposure, crushing, or chemical exposure.

Physical injury

 **CAUTION** **Moving and Lifting Injury.** The instrument is to be moved and positioned only by the personnel or vendor specified in the applicable site preparation guide.

Improper lifting can cause painful and permanent back injury.

Things to consider before lifting or moving the instrument or accessories:

- Depending on the weight, moving or lifting may require two or more persons.
- If you decide to lift or move the instrument after it has been installed, do not attempt to do so without the assistance of others, the use of appropriate moving equipment, and proper lifting techniques.
- Ensure you have a secure, comfortable grip on the instrument or accessory.
- Make sure that the path from where the object is to where it is being moved is clear of obstructions.
- Do not lift an object and twist your torso at the same time. Keep your spine in a good neutral position while lifting with your legs.
- Participants should coordinate lift and move intentions with each other before lifting and carrying.
- For smaller packages, rather than lifting the object from the packing box, carefully tilt the box on its side and hold it stationary while someone else slides the contents out of

the box.

 **CAUTION** **Moving Parts.** Moving parts can crush, pinch and cut. Keep hands clear of moving parts while operating the instrument. Disconnect power before servicing.

Electrical

 **WARNING** **Fuse Installation.** Before installing the instrument, verify that the fuses are properly installed and the fuse voltage matches the supply voltage. Replace fuses only with the type and rating specified for the unit. Improper fuses can damage the instrument wiring system and cause a fire.

 **DANGER** **ELECTRICAL SHOCK HAZARD.** Severe electrical shock can result from operating the Applied Biosystems 3130/3130x/ Genetic Analyzers without its instrument panels in place. Do not remove instrument panels. High-voltage contacts are exposed when instrument panels are removed from the instrument.

 **WARNING** **Voltage Selector Switch.** Before installing the instrument, verify that the voltage selector switch is set for the supply voltage. This will prevent damage to the instrument, reduce risk of fire, and enable proper operation.

 **WARNING** **Ensure appropriate electrical supply.** For safe operation of the instrument:

- Plug the system into a properly grounded receptacle with adequate current capacity.
- Ensure the electrical supply is of suitable voltage.
- Never operate the instrument with the ground disconnected. Grounding continuity is required for safe operation of the instrument.

 **WARNING** **Power Supply Line Cords.** Use properly configured and approved line cords for the power supply in your facility.

 **WARNING** **Disconnecting Power.** To fully disconnect power either detach or unplug the power cord, positioning the instrument such that the power cord is accessible.

Overvoltage Rating

The Applied Biosystems 3130/3130x/ Genetic Analyzers have an installation (overvoltage) category of II, and is classified as portable equipment.

Laser

 **WARNING LASER HAZARD.** Under normal operating conditions, the Applied Biosystems 3130/3130x/ Genetic Analyzers are categorized as a Class I laser product. However, removing the protective covers and (when applicable) defeating the interlock(s) may result in exposure to the internal Class 3B laser. Lasers can burn the retina, causing permanent blind spots. Use of controls or adjustments or performance of procedures other than those specified herein may result in hazardous radiation exposure. To ensure safe laser operation:

- Never look directly into the laser beam.
- Do not remove safety labels, instrument protective panels, or defeat safety interlocks.
- The system must be installed and maintained by an Applied Biosystems Technical Representative.

Applied Biosystems Technical Representatives are instructed to:

- Remove jewelry and other items that can reflect a laser beam into your eyes or those of others
- Wear proper eye protection and post a laser warning sign at the entrance to the laboratory if the laser protection is defeated for servicing.

DO NOT operate the laser when it cannot be cooled by its cooling fan; an overheated laser can cause severe burns on contact.

Note the laser warnings provided in [“Safety alerts on this instrument” on page 166.](#)

 **CAUTION LASER HAZARD, Bar Code Scanner.** The bar code scanner included with the instrument system is a Class 2 laser. To avoid damage to eyes, do not stare directly into the beam or point into another person's eyes.

Laser Classification

The Applied Biosystems 3130/3130x/ Genetic Analyzers use an Argon laser. Under normal operating conditions, the instrument laser is categorized as a Class I laser. When safety interlocks are disabled during certain servicing procedures, the laser can cause permanent eye damage, and, therefore, is classified under those conditions as a Class 3B laser.

The Applied Biosystems 3130/3130x/ Genetic Analyzers have been tested to and comply with 21 CFR, 1040.10 and 1040.11, as applicable.

The Applied Biosystems 3130/3130x/ Genetic Analyzers have been tested to and comply with standard EN60825-1, “Radiation Safety of Laser Products, Equipment Classification, Requirements, and User’s Guide.”

Safety and electromagnetic compatibility (EMC) standards

This section provides information on:

- [U.S. and Canadian Safety Standards](#)
- [Canadian EMC Standard](#)
- [European Safety and EMC Standards](#)

- [Australian EMC Standards](#)

The instrument design and manufacture complies with the standards and requirements for safety and electromagnetic compatibility as noted in the following table:

Safety

Reference	Description
21 CFR 1040.10 and 1040.11 except for deviations pursuant to Laser Notice No.50, dated June 24, 2007, as applicable	U.S. FDA Health and Human Services (HHS) “Radiological health performance standards for laser products” and “Radiological health performance standards for specific purpose laser products”

EMC

Reference	Description
FCC Part 18 (47 CFR)	U.S. Standard “Industrial, Scientific, and Medical Equipment”

U.S. and Canadian Safety Standards



This instrument has been tested to and complies with standard UL 61010-2:2001, “Safety Requirements for Electrical Equipment for Laboratory Use, Part 1: General Requirements.”

This instrument has been tested to and complies with standard CSA C22.2 No. 61010-1, “Safety Requirements for Electrical Equipment for Measurement, Control, and Laboratory Use, Part 1: General Requirements.”

This instrument has been tested to and complies with standard UL 61010-2-010, “Particular requirements for Laboratory Equipment for the Heating of Materials”.

This instrument has been tested to and complies with standard UL 61010-2-081, “Particular requirements for Automatic and Semi0-Automatic Laboratory Equipment for analysis and other purposes”.

Canadian EMC Standard

This instrument has been tested to and complies with ICES-001, Issue 3: Industrial, Scientific, and Medical Radio Frequency Generators.

European Safety and EMC Standards

Safety



This instrument meets European requirements for safety (Low Voltage Directive 2006/95/EC). This instrument has been tested to and complies with standards EN 61010-1:2001, “Safety Requirements for Electrical Equipment for Measurement, Control and Laboratory Use, Part 1: General Requirements”, EN 61010-2-010, “Particular Requirements for Laboratory Equipment for the Heating of Materials”, EN 61010-2-081:2003, “Particular requirements for Automatic and Semi-Automatic Laboratory Equipment for analysis and other purposes”, and EN 60825:2002, “Radiation safety of laser products, equipment classification, requirements and user’s guide.”

EMC

This instrument meets European requirements for emission and immunity (EMC Directive 89/336/EEC). This instrument has been tested to and complies with standard EN 61326 (Class B), “Electrical Equipment for Measurement, Control and Laboratory Use – EMC Requirements.”

Australian EMC Standards



This instrument has been tested to and complies with standard AS/NZS 2064, “Limits and Methods Measurement of Electromagnetic Disturbance Characteristics of Industrial, Scientific, and Medical (ISM) Radio-frequency Equipment.”

Chemical safety



WARNING GENERAL CHEMICAL HANDLING. To minimize hazards, ensure laboratory personnel read and practice the general safety guidelines for chemical usage, storage, and waste provided below, and consult the relevant SDS for specific precautions and instructions:

- Read and understand the Safety Data Sheets (SDSs) provided by the chemical manufacturer before you store, handle, or work with any chemicals or hazardous materials. To obtain SDSs, see the “Documentation and Support” section in this document.
- Minimize contact with chemicals. Wear appropriate personal protective equipment when handling chemicals (for example, safety glasses, gloves, or protective clothing).
- Minimize the inhalation of chemicals. Do not leave chemical containers open. Use only with adequate ventilation (for example, fume hood).
- Check regularly for chemical leaks or spills. If a leak or spill occurs, follow the manufacturer’s cleanup procedures as recommended in the SDS.
- Handle chemical wastes in a fume hood.
- Ensure use of primary and secondary waste containers. (A primary waste container holds the immediate waste. A secondary container contains spills or leaks from the primary container. Both containers must be compatible with the waste material and meet federal, state, and local requirements for container storage.)
- After emptying a waste container, seal it with the cap provided.
- Characterize (by analysis if necessary) the waste generated by the particular

- applications, reagents, and substrates used in your laboratory.
- Ensure that the waste is stored, transferred, transported, and disposed of according to all local, state/provincial, and/or national regulations.
 - **IMPORTANT!** Radioactive or biohazardous materials may require special handling, and disposal limitations may apply.
-

 **WARNING HAZARDOUS WASTE (from instruments).** Waste produced by the instrument is potentially hazardous. Follow the guidelines noted in the preceding General Chemical Handling warning.

 **WARNING 4L Reagent and Waste Bottle Safety.** Four-liter reagent and waste bottles can crack and leak. Each 4-liter bottle should be secured in a low-density polyethylene safety container with the cover fastened and the handles locked in the upright position.

Cleaning and decontamination

 **CAUTION Cleaning and Decontamination.** Using a cleaning or decontamination method not specified by the manufacturer may result in damage to the equipment. For the protection of others, ensure the instrument is properly decontaminated prior to having the instrument serviced at your facility or before sending the instrument for repair, maintenance, trade-in, disposal, or termination of a loan. Decontamination forms may be requested from customer service.

Biological hazard safety



WARNING BIOHAZARD. Biological samples such as tissues, body fluids, infectious agents, and blood of humans and other animals have the potential to transmit infectious diseases. Follow all applicable local, state/provincial, and/or national regulations. Wear appropriate protective equipment, which includes but is not limited to: protective eyewear, face shield, clothing/lab coat, and gloves. All work should be conducted in properly equipped facilities using the appropriate safety equipment (for example, physical containment devices). Individuals should be trained according to applicable regulatory and company/institution requirements before working with potentially infectious materials. Read and follow the applicable guidelines and/or regulatory requirements in the following:

In the U.S.:

- U.S. Department of Health and Human Services guidelines published in Biosafety in Microbiological and Biomedical Laboratories found at: www.cdc.gov/biosafety
- Occupational Safety and Health Standards, Bloodborne Pathogens (29 CFR§1910.1030), found at: www.access.gpo.gov/nara/cfr/waisidx_01/29cfr1910a_01.html
- Your company's/institution's Biosafety Program protocols for working with/handling potentially infectious materials.
- Additional information about biohazard guidelines is available at: www.cdc.gov

In the EU:

- Check local guidelines and legislation on biohazard and biosafety precaution and refer to the best practices published in the World Health Organization (WHO) Laboratory Biosafety Manual, third edition, found at: www.who.int/csr/resources/publications/biosafety/WHO_CDS_CSR_LYO_2004_11/en/

Safety Labels on Instruments

The following CAUTION, WARNING, and DANGER statements may be displayed on Applied Biosystems instruments in combination with the safety symbols described in the preceding section.

English	Francais
CAUTION Hazardous chemicals. Read the Safety Data Sheets (SDSs) before handling.	ATTENTION Produits chimiques dangereux. Lire les fiches techniques de sûreté de matériels avant la manipulation des produits.
CAUTION Hazardous waste. Read the waste profile (if any) in the site preparation guide for this instrument before handling or disposal.	ATTENTION Déchets dangereux. Lire les renseignements sur les déchets avant de les manipuler ou de les éliminer.
CAUTION Hazardous waste. Refer to SDS(s) and local regulations for handling and disposal.	ATTENTION Déchets dangereux. Lire les fiches techniques de sûreté de matériels et la régulation locale associées à la manipulation et l'élimination des déchets.
WARNING Hot lamp.	AVERTISSEMENT Lampe brûlante.
WARNING Hot. Replace lamp with an Applied Biosystems lamp.	AVERTISSEMENT Composants brûlants. Remplacer la lampe par une lampe Applied Biosystems.
CAUTION Hot surface.	ATTENTION Surface brûlante.

English	Francais
DANGER High voltage.	DANGER Haute tension.
WARNING To reduce the chance of electrical shock, do not remove covers that require tool access. No user-serviceable parts are inside. Refer servicing to Applied Biosystems qualified service personnel.	AVERTISSEMENT Pour éviter les risques d'électrocution, ne pas retirer les capots dont l'ouverture nécessite l'utilisation d'outils. L'instrument ne contient aucune pièce réparable par l'utilisateur. Toute intervention doit être effectuée par le personnel de service qualifié de Applied Biosystems.
DANGER Class 3B laser radiation present when open and interlock defeated. Avoid direct exposure to laser beam.	DANGER Class 3B rayonnement laser en cas d'ouverture et d'une neutralisation des dispositifs de sécurité. Eviter toute exposition directe avec le faisceau.
DANGER Class 3B laser radiation when open. Avoid direct exposure to laser beam.	DANGER Class 3B rayonnement laser en cas d'ouverture. Eviter toute exposition directe avec le faisceau.
DANGER Class 2(II) laser radiation present when open and interlock defeated. Do not stare directly into the beam	DANGER de Class 2(II) rayonnement laser en cas d'ouverture et d'une neutralisation des dispositifs de securite. Eviter toute exposition directe avec le faisceau.
DANGER Class 2(II) laser radiation present when open. Do not stare directly into the beam.	DANGER de Class 2(II) rayonnement laser en cas d'ouverture. Eviter toute exposition directe avec le faisceau.
DANGER Class 2(II) LED when open and interlock defeated. Do not stare directly into the beam.	DANGER de Class 2(II) LED en cas d'ouverture et d'une neutralisation des dispositifs de securite. Eviter toute exposition directe avec le faisceau.
DANGER Class 2(II) LED when open. Do not stare directly into the beam.	DANGER de Class 2(II) LED en cas d'ouverture. Eviter toute exposition directe avec le faisceau.
CAUTION Moving parts.	ATTENTION Parties mobiles.

Workstation Safety

Correct ergonomic configuration of your workstation can reduce or prevent effects such as fatigue, pain, and strain. Minimize or eliminate these effects by configuring your workstation to promote neutral or relaxed working positions.

 **CAUTION** **MUSCULOSKELETAL AND REPETITIVE MOTION HAZARD.** These hazards are caused by potential risk factors that include but are not limited to repetitive motion, awkward posture, forceful exertion, holding static unhealthy positions, contact pressure, and other workstation environmental factors.

To minimize musculoskeletal and repetitive motion risks:

- Use equipment that comfortably supports you in neutral working positions and allows adequate accessibility to the keyboard, monitor, and mouse.
- Position the keyboard, mouse, and monitor to promote relaxed body and head postures.

Documentation and Support

Related documentation

The following related documents are shipped with the system:

Document title	Pub. Part no.
<i>Applied Biosystems® 3130/3130xl Genetic Analyzers Maintenance, Troubleshooting, and Reference Guide</i>	4477854
<i>Applied Biosystems® 3130/3130xl Genetic Analyzers Quick Reference Card</i>	4477795
<i>Applied Biosystems® 3730/3730xl DNA Analyzers and 3130/3130xl Genetic Analyzers AB Navigator Software Administrator Guide</i>	4477853

Portable document format (PDF) versions of this guide and the documents listed above are also available on the Applied Biosystems 3130 Series Data Collection Software 4 CD.

Note: To open the user documentation included on the Applied Biosystems 3130 Series Data Collection Software 4 CD, use the Adobe® Reader® software available from www.adobe.com.

Note: For additional documentation, see “Obtaining Support” on page 177.

Obtaining SDSs

Safety Data Sheets (SDSs) are available from www.lifetechnologies.com/support.

Note: For the SDSs of chemicals not distributed by Applied Biosystems, contact the chemical manufacturer.

Obtaining Support

For the latest services and support information for all locations, go to:

www.lifetechnologies.com/support

At the website, you can:

- Access worldwide telephone and fax numbers to contact Technical Support and Sales facilities
- Search through frequently asked questions (FAQs)

- Submit a question directly to Technical Support
- Search for user documents, SDSs, vector maps and sequences, application notes, formulations, handbooks, certificates of analysis, citations, and other product support documents
- Obtain information about customer training
- Download software updates and patches

Computer Configuration

Life Technologies Corporation supplies or recommends certain configurations of computer hardware, software, and peripherals for use with its instrumentation. Life Technologies Corporation reserves the right to decline support for or impose extra charges for supporting nonstandard computer configurations or components that have not been supplied or recommended by Life Technologies Corporation. Life Technologies Corporation also reserves the right to require that computer hardware and software be restored to the standard configuration prior to providing service or technical support. For systems that have built-in computers or processing units, installing unauthorized hardware or software may void the Warranty or Service Plan.

Limited Product Warranty

Life Technologies and/or its affiliate(s) warrant their products as set forth in the Life Technologies' General Terms and Conditions of Sale found on Applied Biosystems' website at www.lifetechnologies.com/termsandconditions. If you have any questions, please contact Life Technologies at www.lifetechnologies.com/support.

If for any reason it becomes necessary to return material to Life Technologies, contact Life Technologies Technical Support or your nearest Life Technologies subsidiary or distributor for a return authorization (RA) number and forwarding address. Place the RA number in a prominent location on the outside of the shipping container, and return the material to the address designated by the Life Technologies representative.

Numerics

- 3130 basecaller and DyeSet/Primer files 78
- 3130 series software license 159

A

- Activating spectral calibration 57
- AmpFISTR kits
 - matrix standard 40
 - table of dye sets, filter, modules 13
- analysis protocol
 - deleting 79
 - editing 79
 - export 80
 - general description 66
 - import 80
 - options 68
- analysis, manual 64, 92
- analyzing GeneMapper Software data 140
- anode buffer reservoir
 - filling 29
 - function 20
- Applied Biosystems
 - contacting 177
 - Technical Support 177
- array length, polymer type, table 46
- array port, illustration of 21
- assembling the plate 44
- Australian EMC standards 171
- autoanalysis
 - manually, fragment analysis documentation 92
 - manually, sequencing documentation 64
 - sequencing 64
- autoextraction
 - overview 132
- autosampler 28
 - function 20

B

- barcode reader 15
- barcode, type of search 50
- basecaller and DyeSet/Primer files 77
- basecaller files 77, 78
- BigDye® Direct Cycle Sequencing Kit

- table of information 39
- BigDye® Primer Cycle Sequencing Kits
 - table of information 39
- BigDye® Terminator chemistry, information tables 77
- BigDye® Terminator v1.1 Cycle Sequencing Kit
 - table of information 39
- BigDye® Terminator v3.1 Cycle Sequencing Kit
 - table of information 39
- biohazard safety 173
- buffer
 - hazards 42
 - making 26
- buffer fill-line 21
- buffer reservoir, anode, illustration of 21
- buffer valve pin, illustration of 21

C

- calibration standards
 - types, fragment analysis 40
 - types, sequencing 39
- Canadian safety standards 170
- CAP polymer
 - fragment analysis application/kit and run modules, SSCP 13
 - fragment analysis run module specifications 12
 - general use guidelines 22
 - run modules 46
- cap/array viewer 129
- capillaries viewer 128
- capillary array
 - function 20
 - illustration of 21
 - installing or replacing 22
- capillary array knob and tip, illustration of 21
- capillary array length
 - polymer type, table 46
- cathode buffer reservoir, filling 27
- Change Polymer Type Wizard, using 25
- characters
 - acceptable 64, 92
- check valve
 - diagram of 21
- chemical safety 171

cleaning safety 172

computer

- assigning a unique name 18
- starting 16

condition number, spectral calibration 52

creating

- analysis protocol for autoanalysis 72
- GeneMapper Software plate record 109
- Sequencing Analysis plate record for autoanalysis 88

D

data

- how to zoom 128
- viewing 122
- viewing analyzed sequencing data 140
- viewing complete run 131

Data Collection software

- starting 18

data collection software, starting 18

decontamination safety 172

destinations 132

detection cell block and heater

- function 20

dGTP BigDye® Terminator v1.0 Cycle Sequencing Ready Reaction Kit

- table of information 39

dGTP BigDye® Terminator v3.0 Cycle Sequencing Ready Reaction Kit

- table of information 39

documentation

- GeneMapper Software User Guide (PN) 92

documentation, related 177

double-tapered ferrule, illustration of 21

dRhodamine Terminator Cycle Sequencing Kit

- table of information 39

dye primer chemistry, information table 78

dye set

- fragment analysis 40, 100
- table, sequencing 39

dye set G5-RCT

- recommendations for use 145, 159

Dye Terminator chemistry, files 77, 78

DyeSet/Primer files 77, 78

- list of 74

E

E dye set, sequencing kit table 71

electrical safety 168

electrical shock hazards 168

electrode, illustration of 21

electromagnetic compatibility standards. *See* EMC standards

electropherogram, definition 128

EMC standards 169

- Australian 171
- Canadian 170
- European 171

EPT chart 126

ergonomic safety 174

errors box 125

European EMC standards 171

European safety standards 171

event log 127

- icon, displays 130

events, box 125

F

file extension 140

file naming, invalid characters 64

fill down special, function 48

fill line, anode buffer reservoir 29

filter set

- fragment analysis 13

find all plate search 50

fragment analysis

- data analysis 140
- filter set 13
- kit types 13
- passing profiles, spectral calibration 61
- run modules 99
- run, average time 118

function 20

G

GeneMapper Software

- computer name 93
- elements 95
- generic 93
- instrument protocol 94
- plate records 94
- results group 94

GeneMapper™ Software and GeneMapper™ ID Software 92

H

hard drive space, automatic checking 117

hazards

- electrical shock 168
- repetitive motion 174

I

- illustration of 21
- Install Array Wizard
 - using 23
- installation category 168
- instrument
 - condition, status 125
 - diagram of interior 20
 - EPT status 126
 - layout 10
 - operation 116
 - setup 21
 - starting the system 17
- instrument protocol
 - creating 45
 - creating, for fragment analysis 95, 98
 - general description 65
 - icon, displays 130
 - options, sequencing 68
- instrument safety 167
- instrument status 124
- interconnect tube 21
- invalid characters in names 64, 92

K

- KB Basecaller
 - creating an analysis protocol 74 to 76
 - table of information 11
- KB basecalling run modules 77

L

- labels, instrument safety 173
- laser safety 169
 - laser classification 169, 174
- Launching Data Collection software 18
- layout, instrument 10
- length of read, definition 11
- linking a plate 114
- LOR definition 11
- lower polymer block 20
- lower polymer block, illustration of 21
- Luer fitting, illustration of 21

M

- Managing Software License for 3130 Series Data Collection Software 4 159
- manual analysis, fragment analysis documentation 92
- manual analysis, sequencing documentation 64
- matrix standard
 - fragment analysis 40

- matrix standards
 - fragment analysis 100
 - preparing for sequencing 41
 - sequencing 39
- mixed plate record 65
- modules
 - fragment analysis 12, 13
 - KB basecalling 77
 - sequencing 11
 - spectral 46
- mounting pin, illustration of 21

N

- Naming
 - tab, fragment analysis 104

O

- O-ring, illustration of 21
- oven
 - function 20
- overflow hole, illustration of 21
- overvoltage category (rating) 168
- overvoltage rating 168, 169, 174

P

- pausing a run 118
- PDP motor cover, illustration of 21
- physical injury safety 167
- piston, illustration of 21
- plate assembly
 - diagram 44
 - placing in instrument 49
- plate editor, filling in 47
- plate manager, access 47
- plate record
 - creating 47
 - creating for GeneMapper Software autoanalysis 109
 - creating for Sequencing Analysis autoanalysis 88
 - discussed 65, 94
 - elements, sequencing analysis 66
 - linking and unlinking 114
 - mixed 65
 - search 50
- plate view 122
- plates
 - linking and unlinking from plate records 114
 - sealing 43
- polymer
 - array length, table 46
 - changing to new type 24
 - replenishing or changing 23

- when to add or change 23
- polymer delivery pump
 - diagram 21
- polymer supply bottle cap with hole, illustration of 21
- polymer supply bottle, illustration of 21
- polymer supply tube illustration of 21
- protocol manager, access 45
- pump block 21
 - function 20
- pump chamber, illustration of 21

Q

- quality column 137
- quality value range 137
- Q-value, spectral calibration 52

R

- RA number. *See* return authorization number
- reader, barcode 15
- reextraction
 - editing Results Group, Analysis Protocol, Analysis Method 138
 - results column 136
 - selected samples 139
 - selecting 133
 - window elements 134
- reextraction panel
 - effects of changes made in 132
- repetitive motion hazard 174
- Replenish Polymer Wizard
 - using 24
- reservoirs
 - filling 27
 - positions on the autosampler 28
- resolution
 - fragment analysis 12
- results column, reextraction 136
- Results Group
 - creating for sequencing analysis 81
 - editor, GeneMapper 93
 - general description 66
 - options 67
 - options, SeqScape software 179
- return authorization (RA) number 178
- run
 - fragment analysis 118
 - requires plate record 65, 94
 - sensor states 125
 - sequencing, average time 117
 - starting 116
 - starting, stopping, skipping, pausing 118
 - viewing data 122

- run history utility 130
- run modules
 - automated steps, description 117
 - selecting for fragment analysis 99
 - selecting spectral 46
- run schedule, viewing 115
- run scheduler
 - spatial 32
 - verifying schedule 115
- run time
 - fragment analysis 12
 - spectral calibration 51
- running buffer, making and storing 26

S

- safety
 - alerts on instrument 166
 - biohazard 173
 - chemical 171
 - cleaning and decontamination 172
 - electrical 168
 - ergonomic 174
 - instrument 167
 - laser 169
 - physical injury 167
 - standards 169
 - symbols on instrument 165
 - workstation 174
- safety labels, on instruments 173
- safety standards
 - Canadian 170
 - European 171
 - U.S. 170
- sample file 132
 - default location 140
 - type 140
- samples
 - loading 42
- sensor states 125
- SeqScape Software analysis 65
- sequencing
 - automated, creating protocols 69
 - automation, required files 65
 - matrix standards 41
 - passing profiles, spectral calibration 59
 - plate editor 65
 - run time 117
 - specifications 11
 - spectral run modules 46
 - viewing analyzed data 140
- service console, using 18
- set (activate) spectral calibration 57
- software license
 - manage 159

- obtain and activate 159
- renew 161
- software, starting 18
- spatial calibration
 - accepting or rejecting 35
 - creating 32
 - evaluating profiles 34
 - examples of profiles 36
 - viewer 130
 - when required 32
- specifications
 - fragment analysis 12
 - sequencing 11
- spectral calibration
 - creating plate record 47
 - evaluating results 53
 - pass/fail status 52
 - passing profiles, fragment analysis 61
 - passing profiles, sequencing 59
 - performing a 47
 - preparing standards for 41
 - run times 51
 - set spectral calibration 57
 - when to perform 38
- spectral calibration standard, types 39
- spectral viewer 130
- spectral viewer, blank or deactivated 58
- standards
 - EMC 169
 - safety 169
- starting
 - run 118
 - spectral calibration run 50
- status
 - instrument 124
 - service console 18
- status lights
 - on instrument startup 17
- stopping a run 118
- symbols, on instrument 165

T

- tables
 - summary 11
- Technical Support, contacting 177
- toolbar 118
- training, information on 178

U

- unlinking a plate 115
- Update Cap Array Info
 - using 23
- US safety standards 170

- utility, run history 130

V

- viewer
 - cap/array 129
 - capillaries 128
 - icons and display information 130
 - spectral 130

W

- water seal, illustration of 21
- water trap
 - illustration of 21
- wizard
 - Replenish Polymer Wizard, using 24
 - Update Cap Array Info, using 23
- workstation safety 174

Z

- Z dye set, sequencing kit table 71



44777963A

Headquarters

5791 Van Allen Way | Carlsbad, CA 92008 USA | Phone +1 760 603 7200 | Toll Free in USA 800 955 6288

For support visit www.lifetechnologies.com/support or email techsupport@lifetech.com

www.lifetechnologies.com

May 2012

