BRAVO

AUTOCLAVES

- Operator's Manual



Bravo Operator's Manual SD-306-4-EN, Copyright 2010 SciCan Ltd. All rights reserved.

TABLE OF CONTENTS

1. INTRODUCTION	1
SYMBOLS USED IN THE MANUAL	1
DISCLAIMERS	1
GENERAL WARNINGS	2
2. RECEIVING YOUR BRAVO	3
SHIPPING WEIGHT	3
DESCRIPTION OF PACKAGE CONTENTS	3
HANDLING THE UNIT	4
3. PRODUCT OVERVIEW	5
GENERAL CHARACTERISTICS	5
FRONT	6
REAR	7
CONTROL PANEL	8
COMMAND KEYS	8
LCD DISPLAY	8
SAMPLE OPERATING CYCLE	9
4. INSTALLATION	10
DIMENSIONS AND WEIGHT	10
COMPARTMENT DIMENSIONS FOR BUILT-IN INSTALLATIONS	10
GENERAL INSTALLATION PRECAUTIONS	11
ELECTRICAL CONNECTIONS	11
CONNECTING THE DATA RECORDER	11
CONNECTING AN EXTERNAL WATER TANK	12
DIRECT CONNECTION TO A CENTRALIZED DRAINING POINT	13
5. INSTRUCTIONS FOR USE	14
TURNING ON THE UNIT	14
INITIAL AUTOMATIC TEST	14
AMBIENT PRESSURE VALUES	14
STAND-BY MODE	15
FILLING DISTILLED WATER	16
Manual filling	16
Automatic filling	16
MAX LEVEL IN THE INTERNAL DRAIN TANK	17
6. CONFIGURATION	18
STARTING AND ENTERING THE SETUP MODE	18
HOW THE KEYS FUNCTION IN SETUP MODE	18
DESCRIPTION OF THE MENU ITEMS	20
DEFAULTS SETTINGS	22
CONFIGURATION OPTIONS	22
Setting the language	22
Setting the date	22
Setting the time	23
Setting the password	23
Setting the sterilization programs	24
Setting the STAND-BY mode	28
Setting the printing mode	29
Setting the tank filling mode	31
Setting the water draining mode	31
Acquisition of the ambient pressure	32
Adjusting the contrast of the liquid crystal display	33
EXIT THE CONFIGURATION MODE	33

TABLE OF CONTENTS

7. PREPARING MATERIAL FOR STERILIZATION	34
TREATING TEXTILE MATERIAL BEFORE STERILIZATION	34
ARRANGING THE LOAD.....	34
8. PROGRAM SELECTION	36
INTRODUCTION.....	36
PROCEDURE	36
9. RUNNING THE CYCLE	38
STARTING THE CYCLE	38
PROGRAM EXECUTION.....	39
RESULT OF THE CYCLE	43
CHECKING THE CYCLE DATA REPORT (FOR UNITS WITH PRINTERS)	44
MANUAL CYCLE INTERRUPTION.....	44
RESETTING THE SYSTEM.....	45
10. STORING STERILIZED MATERIALS	46
INTRODUCTION.....	46
HANDLING.....	46
STORAGE.....	46
11. TEST PROGRAMS	47
INTRODUCTION.....	47
BOWIE & DICK TEST	47
VACUUM TEST.....	48
APPENDIX A – TECHNICAL CHARACTERISTICS	50
SUMMARY TABLE.....	50
SAFETY DEVICES.....	51
WATER SUPPLY CHARACTERISTICS	52
APPENDIX B – PROGRAMS	53
INTRODUCTION.....	53
PROGRAM SUMMARY TABLE	54
STERILIZATION PROGRAM DIAGRAM	56
DIAGRAMS OF THE TEST CYCLES.....	61
EXAMPLES OF PRINTED REPORTS	62
APPENDIX C - MAINTENANCE	64
ROUTINE MAINTENANCE	64
MAINTENANCE DESCRIPTION.....	65
Clean door gasket and porthole (door plate).....	65
Clean external surfaces	65
Clean sterilization chamber and accessories.....	65
Disinfect external surfaces.....	65
Clean internal distilled water tank	66
Clean external distilled water tank	66
Safety valve maintenance.....	66
Clean/replace the drain filter	66
Replace bacteriological filter	67
Replace the door gasket.....	67
Replacing the printer paper on units equipped with internal printers	68
Periodic sterilizer calibration and 3000 cycle maintenance.....	68

APPENDIX D – TROUBLESHOOTING69

APPENDIX E – ALARMS72

ALARMS72

ALARM INTERVENTION.....72

 Alarm during a cycle.....72

 Alarm outside the cycle73

RESETTING THE SYSTEM74

ALARM CODES.....75

ANALYSIS AND RESOLUTION OF PROBLEMS.....77

APPENDIX F – DIAGRAMS83

ELECTRICAL DIAGRAM83

PLUMBING DIAGRAM84

PLUMBING DIAGRAM84

APPENDIX G - NOTES85

APPENDIX H – SPARE PARTS & ACCESSORIES.....86

APPENDIX I – TECHNICAL SUPPORT87

APPENDIX J – LIMITED WARRANTY88

BRAVO and Your Infection Control Specialist are trademarks of SciCan Ltd.
All other trademarks referred to in this manual are the property of their respective owners.

For all service and repair inquiries:

Canada 1-800-870-7777
 United States: 1-800-572-1211
 EU: +49 (0) 7561 98343-0
 International: +1 (416) 446-4500
 Email: techservice.ca@scican.com (Canada)
 techservice.us@scican.com (USA)
 techservice.int@scican.com (International)

Manufactured by:
SciCan Ltd.
 1440 Don Mills Road
 Toronto ON M3B 3P9
 Canada
 Phone: (416) 445-1600
 Fax: (416) 445-2727
 Toll Free: 1-800-667-7733



SciCan, Inc.

701 Technology Drive
 Canonsburg, PA 15317
 USA
 Phone: (724) 820-1600
 Fax: (724) 820-1479
 Toll Free: 572-1211

EU REPRESENTATIVE:

SciCan GmbH
 Wangener Strasse 78
 88299 Leutkirch
 GERMANY
 Phone: +49 (0)7561 98343 - 0
 Fax: +49 (0)7561 98343 - 699

SciCan Medtech AG

Alpenstrasse 16
 6300 Zug Switzerland
 Phone: +41 (0) 41 727 7027
 Fax: +41 (0) 41 727 7029

1. INTRODUCTION

Congratulations on your selection of the Bravo™ Autoclave. We are confident that you have purchased the finest equipment of its type. The Bravo is a counter-top unit that features a number of sterilizing cycles designed to meet your needs and suitability for steam sterilization.

The details of installing, operating and maintaining your Bravo are all contained within this operator's manual. To ensure years of safe, trouble-free service please read these instructions before operating this unit and keep them for future reference. Operational, maintenance and replacement instructions should be followed for the product to perform as designed. Contents of this manual are subject to change without notice to reflect changes and improvements to the Bravo product.

SYMBOLS USED IN THE MANUAL

NOTE



THIS SYMBOL INDICATES IMPORTANT INFORMATION.

WARNING



THIS SYMBOL INDICATES A POTENTIAL DANGER OF INJURY. FOLLOW THE PROCEDURES DESCRIBED IN THE MANUAL TO AVOID INJURING THE USER AND/OR OTHERS.

DANGER



THIS SYMBOL INDICATES A POTENTIAL DANGER OF PROPERTY DAMAGE. FOLLOWS THE INSTRUCTIONS IN THE MANUAL TO PREVENT POTENTIAL DAMAGE TO MATERIALS, EQUIPMENT OR OTHER PROPERTY.

DANGER



THIS SYMBOL INDICATES A POTENTIAL DANGER DUE TO HIGH TEMPERATURE.

DISCLAIMERS

The Bravo units described in this manual are to be used exclusively for the sterilization of solid and hollow re-usable instruments and porous materials (e.g., textiles).

WARNING



THE DEVICE MUST ONLY BE USED BY QUALIFIED PERSONNEL. IT MAY NOT BE USED OR HANDLED BY INEXPERIENCED AND/OR UNAUTHORIZED PERSONNEL FOR ANY REASON. THIS DEVICE MUST NOT BE USED FOR THE STERILIZATION OF FLUIDS, LIQUIDS OR PHARMACEUTICAL PRODUCTS.

Do not permit any person other than certified personnel to supply parts for, service or maintain your Bravo. SciCan shall not be liable for incidental, special or consequential damages caused by any maintenance or services performed on the Bravo by a third party, or for the use of equipment or parts manufactured by a third party, including lost profits, any commercial loss, economic loss, or loss arising from personal injury.

Never remove the cover of the unit and never insert objects through holes or openings in the cabinetry. Doing so may damage the unit and / or pose a hazard to the operator.

All elements of this book are common to Bravo¹⁷, Bravo^{17V} and Bravo^{21V}, except where noted.

GENERAL WARNINGS

Please observe the following precautions in order to avoid injury or property damage:

- Use **ONLY** high quality **distilled water**.



WARNING

THE USE OF WATER OF INADEQUATE QUALITY CAN SEVERELY DAMAGE THE UNIT. FOR MORE INFORMATION, SEE APPENDIX A, TECHNICAL CHARACTERISTICS.

- **Do not** pour water or other liquids on the device;
- **Do not** pour flammable substances on the device;
- **Do not** use the device in the presence of gas or explosive or flammable vapors;
- Before performing any maintenance or cleaning, **ALWAYS DISCONNECT** the power supply.



WARNING

WHEN IT IS NOT POSSIBLE TO DISCONNECT THE UNIT'S POWER SUPPLY, WHEN THE EXTERNAL POWER GRID SWITCH (MAIN BREAKER) IS FAR AWAY OR, WHEN IT IS NOT VISIBLE FROM THE UNIT, PLACE A WORK IN PROGRESS SIGN ON THE EXTERNAL POWER GRID SWITCH (MAIN BREAKER) AFTER TURNING IT OFF.

- Make sure the electrical system is **grounded** conforming to current laws and/or standards;
- **Do not** remove any label or nameplate from the device; request new ones, if necessary.
- Use **only original replacement parts**.



WARNING

FAILURE TO OBSERVE THE WARNINGS LISTED ABOVE RELEASES THE MANUFACTURER FROM ALL LIABILITY.

2. RECEIVING YOUR BRAVO

SHIPPING WEIGHT

Total shipping weights :

- Bravo¹⁷: approximately 126 lbs / 57 kg
- Bravo^{17V}: approximately 136 lbs / 62 kg
- Bravo^{21V}: approximately 150 lbs / 68 kg

NOTE



CHECK THE INTEGRITY OF THE PACKAGE UPON RECEIPT.

Confirm that:

- the contents match the specifications of the order (see the accompanying document);
- there is no obvious damage to the contents.

NOTE



IF YOU HAVE RECEIVED THE WRONG PRODUCT, ARE MISSING PARTS, OR IF YOUR UNIT HAS ANY TYPE OF DAMAGE, IMMEDIATELY PROVIDE A DETAILED DESCRIPTION TO THE SELLER AND SHIPPER.

DESCRIPTION OF PACKAGE CONTENTS

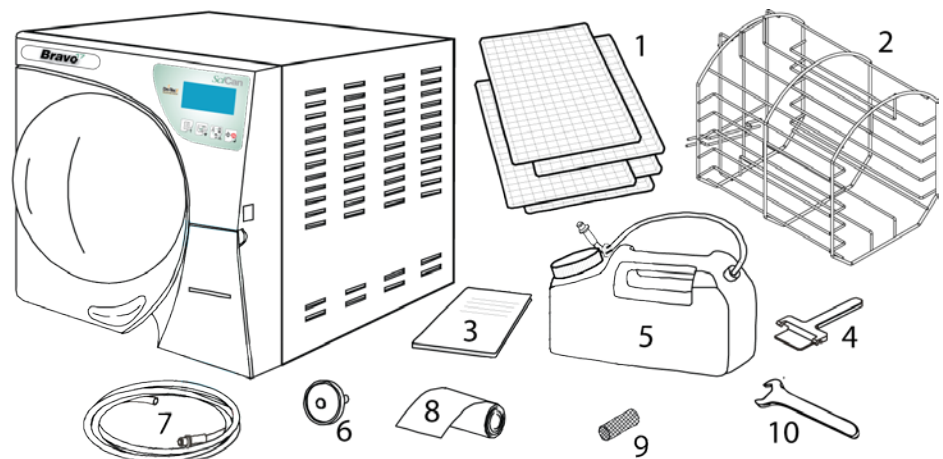

The package contains:

- **Bravo Steam sterilizer**
 1. Stainless steel wire instrument tray (3 pc with Bravo¹⁷, 5pc with Bravo^{17V}, Bravo^{21V});
 2. Stainless steel rack;
 3. Instruction/Operators manual and other documents;
 4. Tray extractor;
 5. Container with quick connect for adding distilled water (about 0.5 US gal / 2 L);
 6. Extra bacteriological filter;
 7. Silicone tube (6.5 ft / 2 m) for draining water, with quick connector;
 8. Bravo^{17V} and Bravo^{21V} models include spare roll of printer paper;
 9. Chamber drain filter
 10. Chamber drain filter wrench

NOTE



THE CUSTOMER MUST KEEP THE PURCHASE RECEIPT FOR ANY WARRANTY SERVICE.

2. RECEIVING YOUR BRAVO

HANDLING THE UNIT

Where possible, the packaged product must be handled using suitable mechanical means and following the instructions shown on the package.
In the case of manual handling, the product must be lifted by two people using the handles cut in the side of the box.

Once removed from the box, the unit must be lifted by two people and transported on a cart or other similar device.

WARNING



WE RECOMMEND THAT THE UNIT BE TRANSPORTED AND STORED AT A TEMPERATURE NO LOWER THAN 5 °C. PROLONGED EXPOSURE TO LOW TEMPERATURES COULD DAMAGE THE PRODUCT.

NOTE



KEEP THE ORIGINAL PACKAGING AND USE IT WHEN THE DEVICE IS TRANSPORTED. USING DIFFERENT PACKAGING COULD DAMAGE THE PRODUCT DURING SHIPPING.

DANGER



BEFORE SHIPPING, DRAIN THE DISTILLED WATER AND USED WATER TANKS, AND ENSURE THE DEVICE HAS BEEN OFF FOR 30 MINUTES FOLLOWING ITS LAST CYCLE SO THAT THE ALL THE HOT INTERNAL PARTS WILL HAVE TIME TO COOL.

3. PRODUCT OVERVIEW

Bravo is SciCan's revolutionary chamber autoclave designed with safety, performance, flexibility and ease of use in mind.

It is a sophisticated yet easy-to-use sterilizer with a wide range of configuration options and patented operating devices designed to satisfy every need for sterilizing medical and dental tools, guaranteeing the maximum performance under all conditions.

Easy-to-use, compact and aesthetically pleasing, Bravo is the ideal partner for professionals seeking maximum sterilization safety

GENERAL CHARACTERISTICS

Bravo is a microprocessor-controlled steam sterilizer with a large sterilization chamber made of stamped stainless steel.

It is characterized by an advanced fractionated vacuum system for the complete removal of air from hollow and porous materials, and an effective final vacuum drying phase capable of effective drying of these loads.

Its exclusive steam generation system, effective plumbing circuit and electronic management (supplemented by high-precision sensors) guarantees high process execution speeds and excellent thermodynamic parameter stability. Moreover, its Process Evaluation System constantly monitors all the machine's vital parameters in real-time, guaranteeing absolute safety and perfect results.

It offers users 10 sterilization programs (one customizable), each equipped with optimized drying for the fast, effective sterilization of the various types of loads (instruments and materials) used in a medical or dental environment. The custom programs have not been validated and have not been cleared in the U.S. by FDA for healthcare use.

Bravo units also offer a number of interesting options for configuring the preheating mode (based on the sterilizer's frequency of use) and printing the cycle report (printer optional on Bravo17).

Bravo sterilizers also have one of the most complete, sophisticated and advanced safety systems available today to protect users in the case of electrical, mechanical, or thermal operating anomaly.

NOTE



PLEASE REFER TO APPENDIX A (TECHNICAL CHARACTERISTICS) FOR A DESCRIPTION OF BRAVO'S INTEGRATED SAFETY DEVICES.

3. PRODUCT OVERVIEW

FRONT

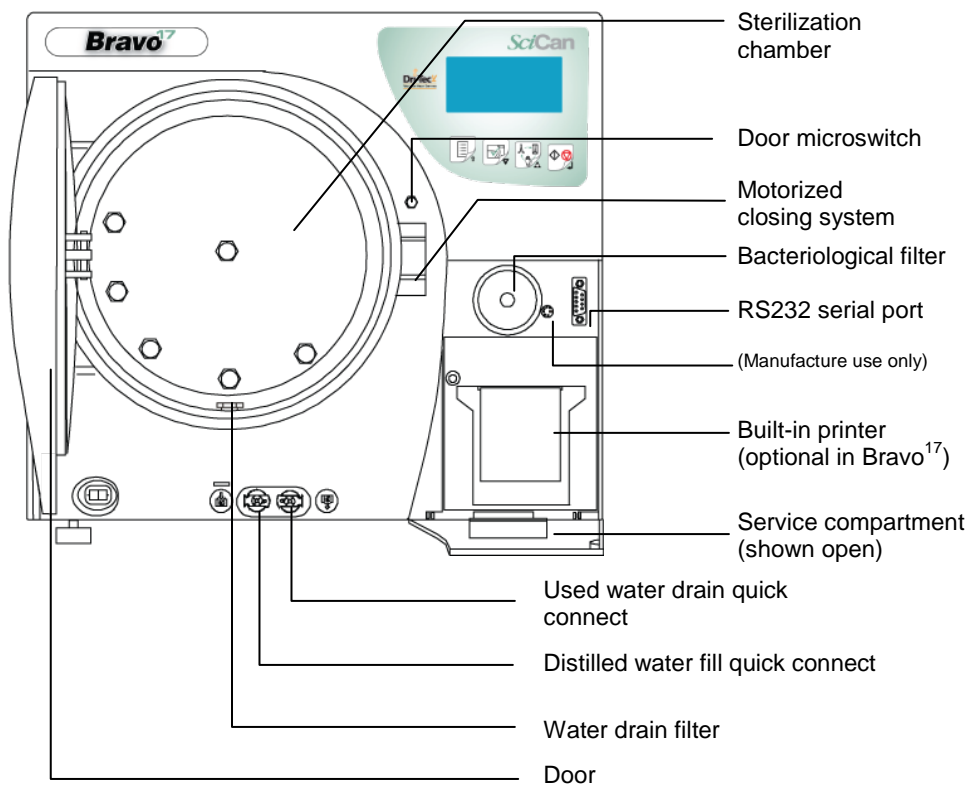
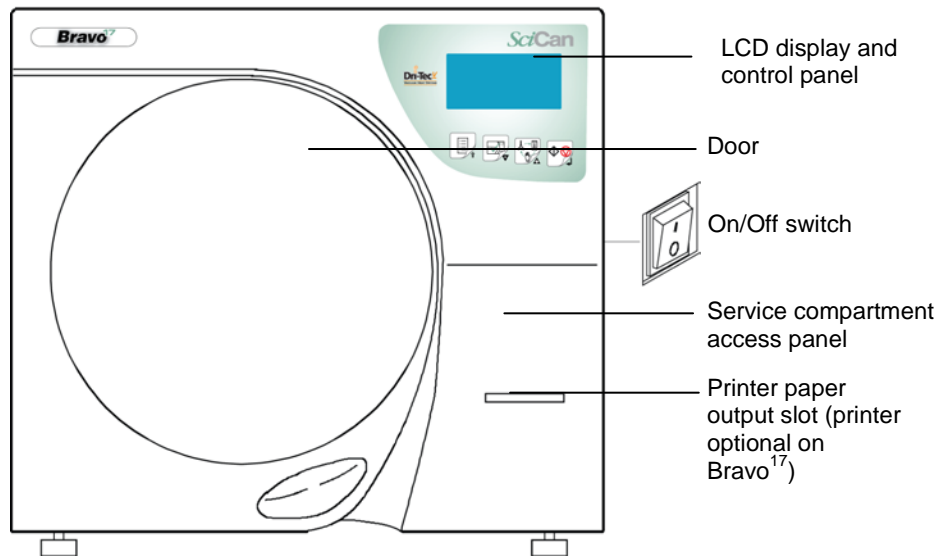

REAR

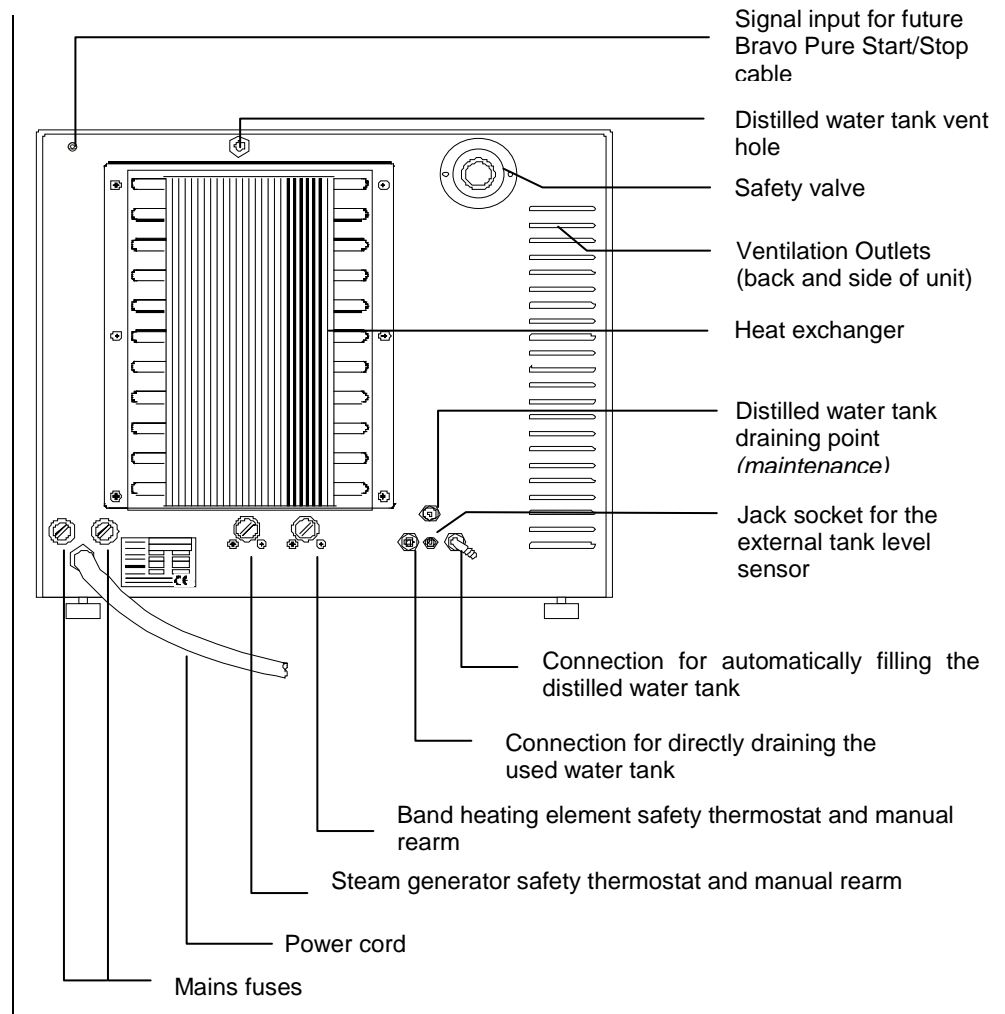

CONTROL PANEL

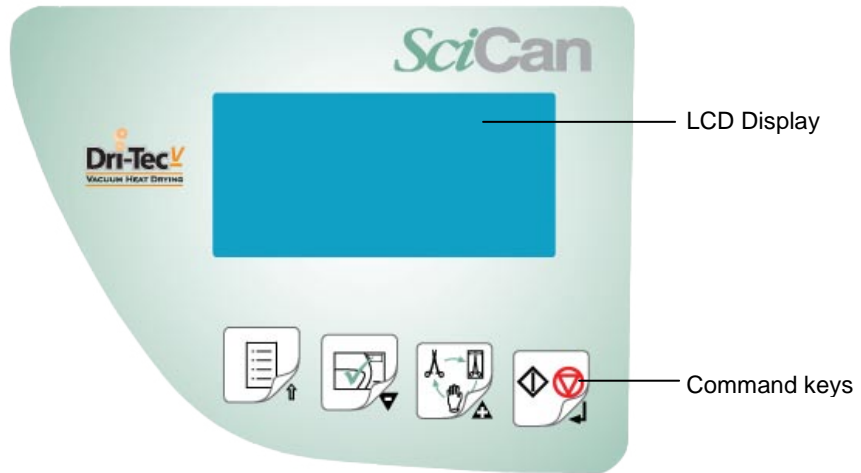

Command keys will perform different functions depending on the mode:

COMMAND KEYS

Key	NORMAL mode	SETUP mode
	Cycle Start/Stop	Enter , confirmation of the value/option selected
	Sterilization cycle selection	Value increment / Forward scroll of the menu options
	Test cycle selection	Value decrement / Backward scroll of the menu options
	Enter Setup mode	ESC , quit the current menu

LCD DISPLAY

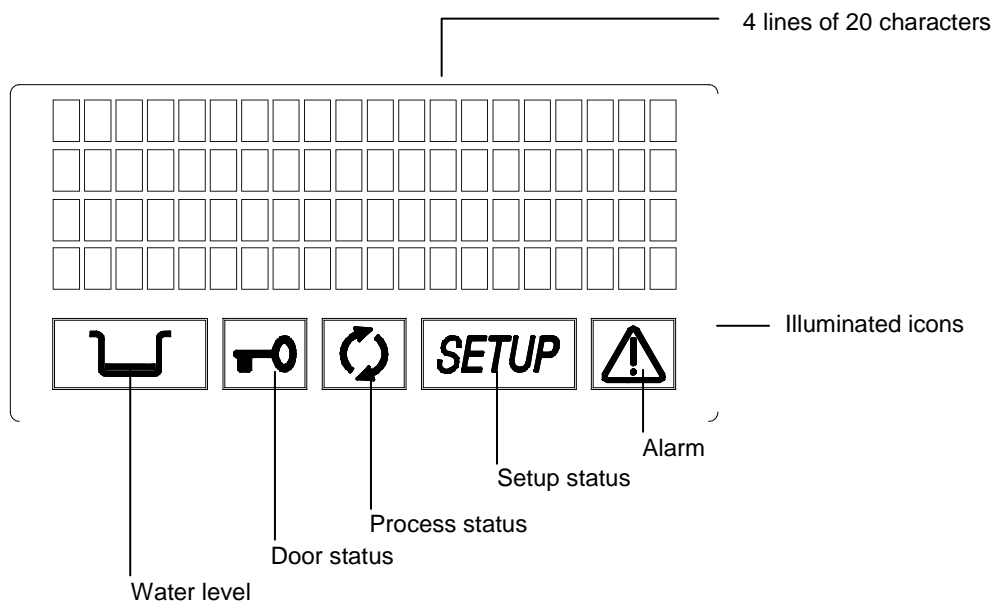

**SAMPLE
OPERATING
CYCLE**

The Bravo's sterilization program is a succession of phases, each with a specific purpose.

After loading the material in the chamber, closing the door, selecting the program and starting the cycle (the door opening mechanism locks automatically), the standard program (for porous materials, 134 °C at 4 minutes, for example) uses the following sequence:

1. Preheats the generator and sterilization chamber;
2. Removes the air and penetrates the material by steam through a series of vacuum (extracting fluid from the sterilization chamber) and pressure (injecting steam into the chamber) phases;
3. Raises the pressure, with the consequent increase in the temperature of the steam, until reaching the conditions required for sterilization (for example, 134 °C);
4. Stabilizes the pressure and temperature;
5. Sterilizes for the required time (for example, 4 minutes);
6. Depressurizes the sterilization chamber;
7. Begins vacuum-drying phase;
8. Ventilates the load with sterile air;
9. Brings the pressure of the sterilization chamber back to the atmospheric level.

After reaching atmospheric pressure, the door is automatically unlocked and can be opened to remove the load from the sterilization chamber.

Phases 1, 3, 4, 6 and 9 are identical in all cycles, with slight variations of duration that are solely dependent on the quantity and consistency of the load and the heating conditions of the sterilizer. Phases 2, 5, 7 and 8, however, vary their configuration and/or duration on the basis of the cycle selected (and, consequently, the type of load) and the choices made by the user.

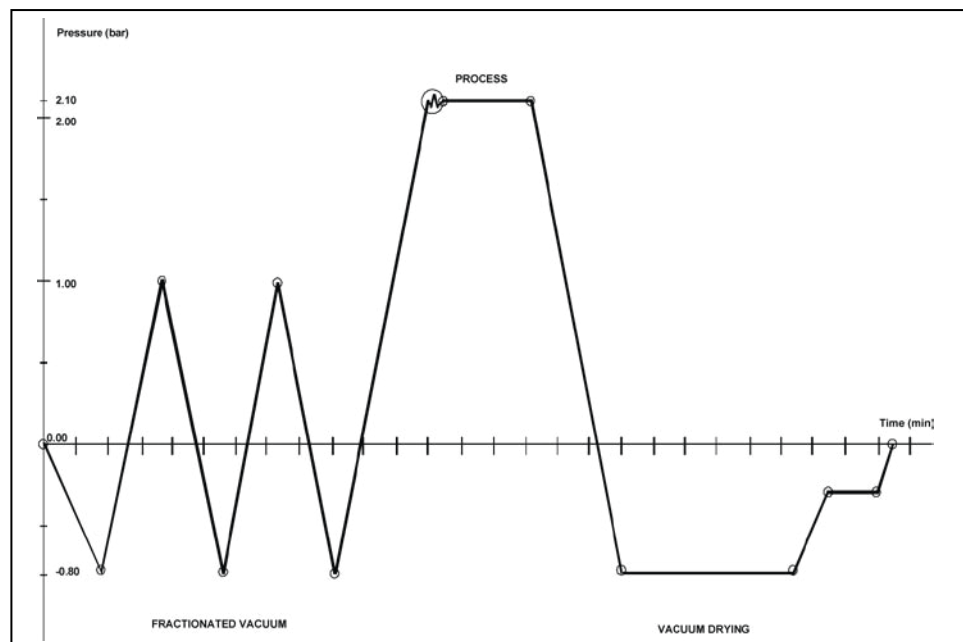
**NOTE**

PLEASE REFER TO APPENDIX B (PROGRAMS) FOR MORE DETAIL.

4. INSTALLATION

4. INSTALLATION

Correct and careful installation will ensure your Bravo functions properly, protects operators from physical injury and protects property from damage.

DIMENSIONS AND WEIGHT

- Height (all models) 16.5" / 420 mm
- Width (all models) 19" / 480 mm
- Depths (excluding rear connections)
 - Bravo¹⁷, Bravo^{17V} 22.0" / 560 mm
 - Bravo^{21V} 25.0" / 635 mm
- Total weights (with rack and trays)
 - Bravo¹⁷: 121 lbs / 55 kg
 - Bravo^{17V}: 128 lbs / 58 kg
 - Bravo^{21V}: 139 lbs / 63 kg

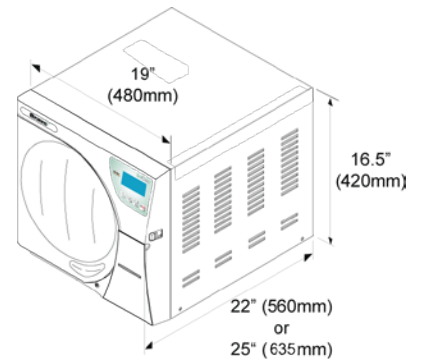

Electricity

The electrical system to which the sterilizer will be connected must accommodate the electrical characteristics of this device. This information is shown on the back of the machine.

COMPARTMENT DIMENSIONS FOR BUILT-IN INSTALLATIONS

When installing the sterilizer inside a cabinet, you must provide adequate space all around the device to provide effective ventilation. There should also be an opening in the back large enough to provide adequate air flow. This will allow optimum cooling of the heat exchanger.

A built-in compartment **MUST** have the minimum dimensions shown in the figure at right.

- Height (all models) 18.5" / 490 mm
- Width (all models) 23" / 580 mm
- Depths
 - Bravo¹⁷, Bravo^{17V} 26" / 660 mm
 - Bravo^{21V} 29" / 735 mm

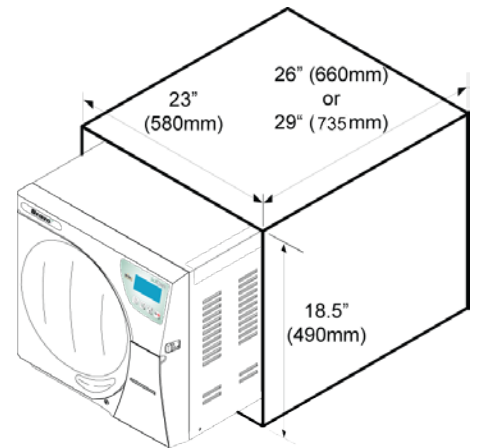

WARNING



COMPARTMENT DIMENSIONS LESS THAN THOSE SHOWN MAY COMPROMISE THE CORRECT CIRCULATION OF AIR AROUND THE DEVICE AND MAY NOT PROVIDE ADEQUATE COOLING. THIS CAN RESULT IN THE DETERIORATION OF PERFORMANCE AND/OR POSSIBLE DAMAGE.

NOTE



DO NOT REMOVE THE UPPER COVER OR ANY OTHER EXTERNAL PART. WHEN INSTALLED IN THE COMPARTMENT, THE DEVICE MUST BE COMPLETE WITH ALL ITS PARTS. PLEASE REFER TO APPENDIX A (TECHNICAL CHARACTERISTICS) FOR COMPLETE TECHNICAL DATA.

GENERAL INSTALLATION PRECAUTIONS

To ensure operator safety and the correct performance of the device:

- Install the sterilizer on a flat level surface strong enough to support the device's weight, and use the leveling feet to compensate for an irregular surface.
- Leave adequate space for ventilation, at least 2" (50 mm) on both side and top and 4" (100mm) at the back. If the device is installed in a cabinet, be sure to respect the warnings in the preceding paragraph, avoiding any obstructions to the air intake.
- Avoid contact with water or liquids. Do not install the sterilizer near tubs, sinks or similar places, as this could cause short circuits and/or potentially dangerous situations for the operator.
- Do not install the sterilizer in a place that is excessively humid or poorly ventilated;
- Do not install the machine where there is gas or flammable and/or explosive vapors;
- Install the device so that the power cord is not sharply bent or kinked. It must run freely to the electrical connection socket.
- Install the device so that any external fill/drain tubing(s) is/are not sharply bent or kinked. These must run freely to the drain tank.

ELECTRICAL CONNECTIONS

The Bravo must be connected to an outlet that provides adequate capacity for the device's absorption and ground, and which conforms with current laws and/or standards. The outlet must also be protected by suitable breaker.

WARNING



THE MANUFACTURER WILL NOT BE LIABLE FOR DAMAGES CAUSED BY INSTALLING THE STERILIZER ON AN INADEQUATE ELECTRICAL SYSTEM OR ONE NOT EQUIPPED WITH A GROUND.

If it is necessary to replace the plug on the power cord, use one with equal characteristics or, at any rate, adequate to the device's electrical characteristics. The user is entirely responsible for the selection and replacement of the plug. This replacement should only be performed by a trained service professional.

NOTE



ALWAYS CONNECT THE POWER CORD DIRECTLY TO THE SOCKET. DO NOT USE EXTENSION CORDS, ADAPTERS OR OTHER ACCESSORIES.

CONNECTING THE DATA RECORDER

The sterilizer can be connected to external data recorder to allow the recording of the cycle data on to a USB memory stick which can then be downloaded to a PC for archiving and management.

The connectors in the service compartment are used for interfacing.

Installation

1. Switch off the sterilizer and open the service compartment door;
2. Insert both ends of the 9-pin connector into the serial ports of the data recorder and the Bravo unit and secure them with the screws.
The serial port of the autoclave can be found next to the biological filter;
3. Insert the power connector pin in to the data recorder and then plug in the power supply;
4. Fully insert the USB stick in to data recorder.
5. Switch on the sterilizer.

4. INSTALLATION

CONNECTING AN EXTERNAL WATER TANK

To avoid having to regularly fill the internal water tank (see Chapter 5 - Instructions for Use), it is possible to connect the sterilizer to an optional external tank that the user will less frequently fill, or to a commercially-available, water purification system with accumulation tank.

With this option, the autoclave automatically activates a pump that fills the internal tank when it reaches the MIN level. Be sure to monitor the external tank as the Bravo unit can not monitor the water level in the external tank.

To connect the external tank, follow the instructions below:

- Install the tap provided on the tank; use Teflon tape or connector sealant for a perfect seal.

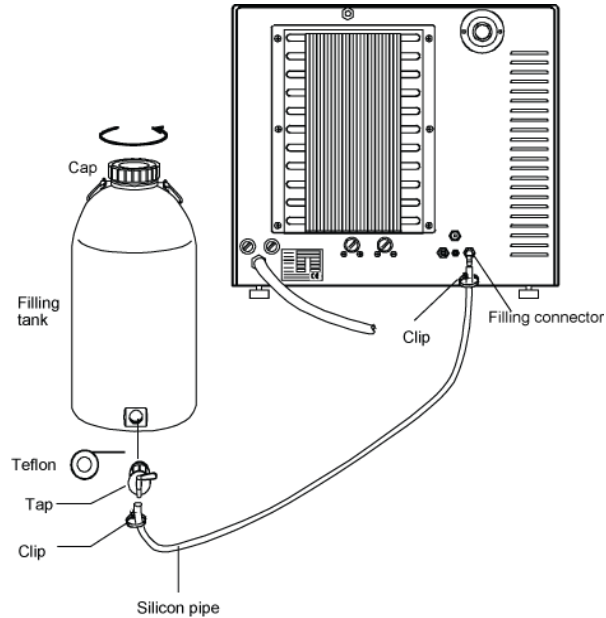

- Use the tank's silicone tube (or other suitable tube) and insert it on the filling connector taking care to push it completely on.
- Lock the tube to connector with the plastic tie provided.
- Insert the other end of the tube on the tap of the tank.
- Make sure that the tube runs freely from the device to the tank, without being bent, crushed or obstructed in any way.
- Loosen the cap to facilitate the flow of water.
- Open the tap on the filling tank.

NOTE



REFER TO CHAPTER 6 - CONFIGURATION – SETTING THE TANK FILLING MODE.

DIRECT CONNECTION TO A CENTRALIZED DRAINING POINT

Follow the instructions shown below for a **correct direct connection** to a centralized draining point:

- Insert the silicone tube (provided) or other suitable plastic tube onto hose connection A; push the tube all the way on and lock with the plastic tie or other means;
- Cut the tube to measure, push the free end on the connection provided on the centralized draining point and lock with the plastic tie or other means;

NOTE

 **MAKE SURE THE TUBE IS NOT BENT, KINKED OR OBSTRUCTED IN ANY WAY.**

The following diagram depicts the ideal arrangement of components:

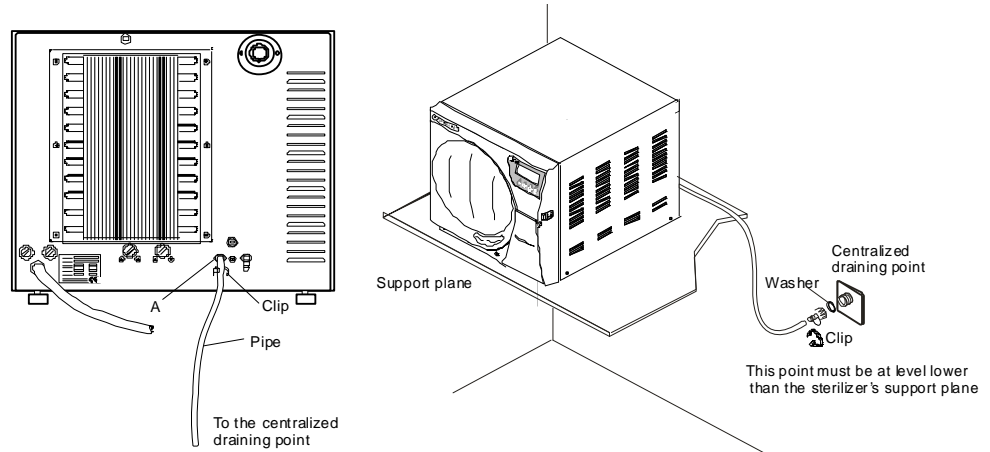

NOTE

 **THE CONNECTION POINT TO THE CENTRAL DRAIN MUST BE LOWER THAN THE STERILIZER'S SUPPORT SURFACE, OTHERWISE THE TANK MAY NOT EMPTY CORRECTLY.**

5. INSTRUCTIONS FOR USE

5. INSTRUCTIONS FOR USE

Once the sterilizer has been correctly installed, it may be turned on and prepared for use.

Turn on the Bravo using the main (luminous) switch located on the right side of the unit.

TURNING ON THE UNIT





NOTE

 DO THIS WITH THE STERILIZER'S DOOR OPEN.

INITIAL AUTOMATIC TEST

When turned on, the control panel lights up and beeps so you can visually check its correct operation. The panel then displays the message:





BRAVO 17
R . E x x x x / B M y y y y y
D E V I C E C H E C K - U P

NOTE





 IF THE DOOR IS CLOSED, THE TEST IS INTERRUPTED. THE PANEL WILL BEEP AND DISPLAY THE FOLLOWING MESSAGE.

O P E N D O O R
T O C O N T I N U E

Open the door to allow the test to continue. At the end of the test you will see:

BRAVO 17
R . E x x x x / B M y y y y y
C H E C K - U P C O M P L E T E











AMBIENT PRESSURE VALUES

The sterilizer measures the ambient pressure for the correct operation of several auxiliary devices. Whenever the difference between the value read and that previously stored is higher than a set value, the system automatically updates the stored value after a brief delay. Otherwise, the data remains unchanged without updating. (see Chapter 6 – Configuration - Acquisition of the ambient pressure)

After updating, the device performs the initial automatic test procedure (see above). At the end, the display shows the following message (accompanied by a beep):

A M B I E N T P R E S S U R E
V A L U E U P D A T E D
- 0 . 0 1 b a r
↵ t o c o n t i n u e

When ↵ is pressed, the device goes to STAND-BY mode (see below).

NOTE

 FOR MORE INFORMATION, SEE CHAPTER 6 – CONFIGURATION - ACQUISITION OF THE AMBIENT PRESSURE.

STAND-BY MODE

After the initial test, the sterilizer goes into **STAND-BY** mode and the display shows:

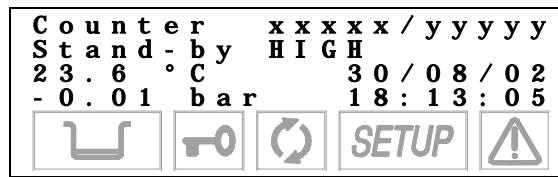

The upper line is the **cycle counter**. It shows the number of sterilizations performed, with the correctly completed cycles on the left and the total number started on the right. The line below shows the Stand-by status and the preheating mode (High-Low-Off). The two lower lines show the temperature and pressure of the sterilization chamber on the left and current **date** and **time** on the right.

NOTE

A CYCLE BEGINS WITH THE START OF THE STERILIZATION CYCLE (FIRST VACUUM PHASE), EXCLUDING THE PREHEATING PHASE. A CYCLE ENDS AT THE END OF THE PROGRAM (SEE THE CHAPTER 9 - RUNNING THE CYCLE - PROGRAM EXECUTION).

TO SET THE DATE AND TIME AS WELL AS SELECT THE PREHEATING MODE, PRINT THE DATA AND FILL THE TANK, PLEASE REFER TO THE CHAPTER 6.

At regular intervals, the first two lines on the display alternate with the modes set for printing (OFF/ON) and filling (Manual/Automatic):

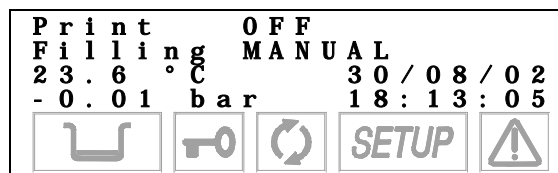

The icons in the lower part of the LCD screen remain off with the exception of the door status and/or water level indicators, which light-up if the door is closed and/or the level in the filling tank reaches its MIN or MAX values (or the MAX value in the drain tank).

During the first start-up, the MIN water level icon in the filling tank is normally on.

The device waits for the selection of the desired sterilization program (see Chapter 8 - **Program Selection**).

DANGER

WHEN THE DOOR IS OPEN IN STAND-BY MODE, A BEEP INDICATES THAT THE SURFACES INSIDE THE DEVICE ARE HOT. TO AVOID BURNS, TAKE CARE NOT TO TOUCH THE STERILIZATION CHAMBER, THE SUPPORTS PROVIDED OR THE INSIDE OF THE DOOR WITH YOUR BARE HANDS.

5. INSTRUCTIONS FOR USE

FILLING DISTILLED WATER

Manual filling

The first time the sterilizer is used or when the MIN water level indicator comes on, you will have to fill, or top-off, the internal distilled water tank.

With reference to the figure (and with the door open), follow these steps:

1. Fill the manual container (2 litres/ 0.52 US gal) with distilled water, keeping it horizontal.
2. Connect the tube's quick connector to the corresponding female connector under the chamber entrance (marked , pushing until you hear a click.
3. Place the container in a vertical position and loosen the cap and taking care not to spill water on the machine.
4. The water will begin to flow into the tank.
5. Continue filling until the MIN level indicator turns off or the MAX level indicator turns on.
6. At this point, lower the bottle below the connection point on the unit, keeping it horizontal.
7. While pinching the tube with your fingers press the metal lever on the side of the connector and detach the quick connector.
8. Refill the container (2 litres/ 0.52 US gal) and repeat steps 2, 3 and 4 a second time until the MAX level icon appears on the display.
9. When the MAX level icon comes on (accompanied by a beep), stop filling and detach the quick connector as described in steps 6 and 7.

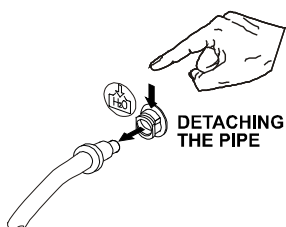
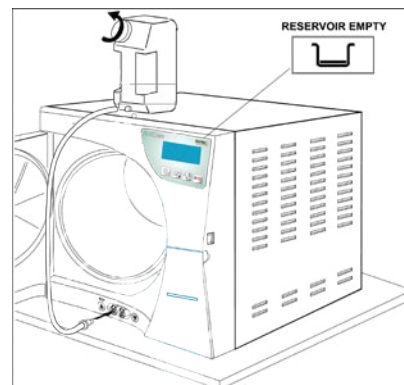

NOTE



THE **MAX** ICON DOES NOT HAVE TO BE ON TO START A STERILIZATION PROGRAM. THERE IS SUFFICIENT WATER IF THE **MIN** INDICATOR IS OFF.

DO NOT CONTINUE TO FILL ONCE **MAX** ICON APPEARS AND YOU HEAR A BEEP. DOING SO MAY CAUSE WATER TO DRAIN FROM THE UNIT'S WATER TANK DRAINING POINT AT THE BACK OF THE MACHINE.

Automatic filling

If a unit is set up for automatic filling from an external tank, the filling will occur automatically after this automatic filling option has been selected.

NOTE



USE **ONLY** HIGH QUALITY DISTILLED WATER. FOR WATER SPECIFICATIONS, SEE APPENDIX A (TECHNICAL CHARACTERISTICS).

To set the automatic filling option, please refer to the Chapter 6 - Configuration – Setting the tank filling mode.

WARNING



THE AUTOMATIC FILLING SYSTEM MUST NEVER RUN DRY. THIS WILL CAUSE PREMATURE WEAR TO THE AUXILIARY WATER-INJECTION PUMP. PERIODICALLY CHECK THE WATER LEVEL IN THE EXTERNAL TANK.

IF AUXILIARY WATER-INJECTION PUMP RUNS DRY, THIS MAY BE AN INDICATION OF AN EMPTY EXTERNAL WATER TANK, AND THE UNIT WILL DISPLAY A CYCLE FAULT A040. TURN OFF THE POWER TO THE UNIT AND FILL THE EXTERNAL BOTTLE WITH DISTILLED WATER. THEN TURN THE UNIT POWER ON.

MAX LEVEL IN THE INTERNAL DRAIN TANK

When the water level in the internal drain tank reaches the MAX level, the LCD display alternatively flashes the MAX and MIN icons.

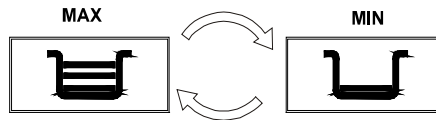

NOTE

 AT THIS STAGE, THE UNIT WILL GENERATE AN ALARM INDICATION (SEE APPENDIX E - ALARMS) SHOULD YOU ATTEMPT TO START A STERILIZATION CYCLE.

When this occurs, empty the internal and/or external draining tank.

Emptying the internal tank

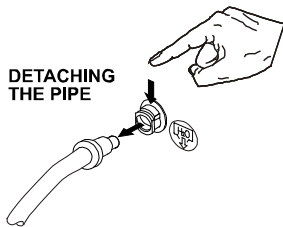

To drain the internal tank, follow these steps :

1. Arrange an empty container on the floor near the sterilizer and put the free end of the supplied tube into the container.
2. Connect the quick connector to the corresponding female connector under the chamber entrance (marked ), pushing until you hear a click.
3. Wait for the internal tank to drain completely, then while pinching the tube with your fingers, press the metal lever located on the side of the connector and detach the quick connector.

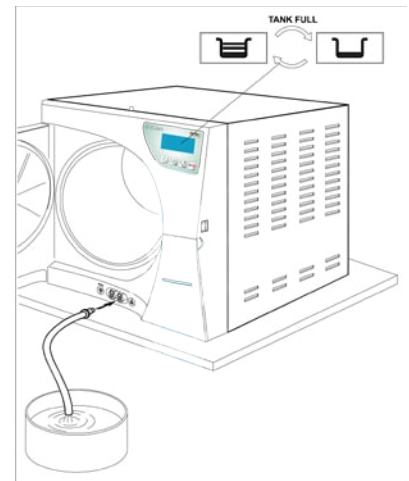

6. CONFIGURATION

Bravo users can configure the device to meet their specific needs. For example, the device's performance may be adapted on the basis of the type of activity, the type of material to be sterilized or its frequency of use.

The **SETUP** program allows selecting from several options that users can activate through an easy-to-use menu.

NOTE

 **USE THE **SETUP** PROGRAM WHEN NECESSARY. A CORRECTLY PERSONALIZED DEVICE PROVIDES THE BEST PERFORMANCE. SciCAN CUSTOMER SUPPORT (SEE APPENDIX Z) IS AVAILABLE TO HELP USERS BY PROVIDING SUGGESTIONS OR ADVICE ON THE BEST WAY TO USE THE OPTIONS IN THE **SETUP** PROGRAM.**

STARTING AND ENTERING THE SETUP MODE



To enter the **SETUP** mode, hold down the ↑ key on the control panel for several seconds, until the display reads "INSERT PASSWORD". Enter the password "- - - - -" (8 x ) then press the ↓ key to enter the **SETUP** mode

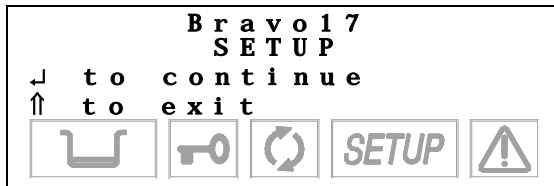
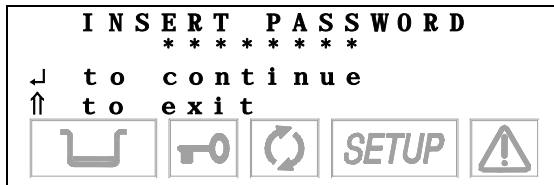

NOTE

 **THE ICON **SETUP** ON THE DISPLAY WILL LIGHT UP AND STAY ON FOR THE ENTIRE CONFIGURATION PHASE.**

Press the ↓ key to enter the **SETUP** mode. The screen shows the first-level menu items (see **SETUP flowchart** below).





Pressing the **ESC** key ↑ quits the **SETUP** program and takes you back to normal operation (stand-by mode).

NOTE

 **THE **SETUP** PROGRAM CAN ONLY BE STARTED IN **STAND-BY** MODE. IT IS NOT ACCESSIBLE DURING STERILIZATION OR TEST CYCLES.**

HOW THE KEYS FUNCTION IN SETUP MODE

In **SETUP** mode the control panel keys have different functions than in normal mode.

Key	SETUP mode
	ENTER key to confirm the selected option or value
	Increases the value /scroll down
	Decreases the value /scroll up the menu items
	ESC key to exit the selected menu option

BRAVO Menu Guide

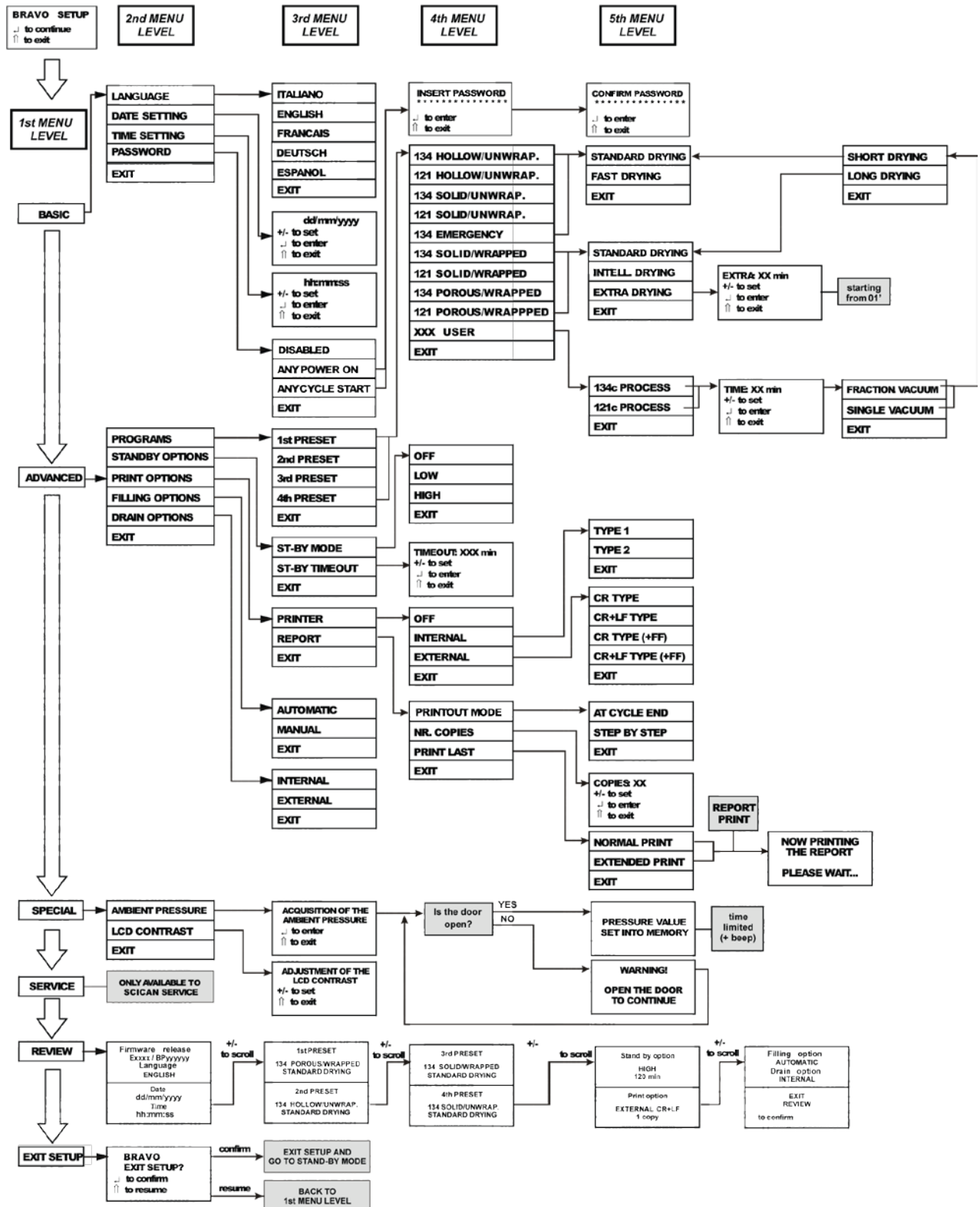

DESCRIPTION OF THE MENU ITEMS

MAIN MENU

The main menu has six entries that allow access to additional (second-level) menus:

BASIC	(basic options)
ADVANCED	(advanced options)
SPECIAL	(special options)
SERVICE	(<i>technician menu not accessible to users</i>)
DATA REVIEW	(summary of options selected)
EXIT SETUP	(exit the SETUP program and return to normal operation. For more info, see Exiting the SETUP program)

BASIC Menu

The Basic menu (basic options) consists of the following items:

LANGUAGE	(language setting)
DATE SETTING	(setting the current date)
TIME SETTING	(setting the current time)
PASSWORD	(setting the password)
EXIT	(exit the BASIC menu and return to the main menu)

ADVANCED Menu

The Advanced menu (advanced options) consists of the following items:

PROGRAMMES	(setting preselected sterilization programs , shown on the LCD display)
STAND-BY OPTIONS	(stand-by mode settings)
PRINT OPTIONS	(setting printer and printing options)
FILLING OPTIONS	(setting modes for filling the distilled water tank)
DRAIN OPTIONS	(setting the modes for emptying the used water tank)
EXIT	(exit the ADVANCED menu and return to the main menu)

SPECIAL Menu

The Special menu (special options) consists of the following items:

AMBIENT PRESSURE	(acquisition of the ambient pressure)
LCD CONTRAST	(adjusting the contrast of the Liquid Crystal Display)
EXIT	(exit the SPECIAL menu and return to the main menu)

SERVICE Menu

The Service menu can **ONLY** be accessed by a SciCan technician.

DATA REVIEW Menu

The Data Review displays a summary of the device's **current settings**, allowing users to verify their accuracy.

It has the following screens (shown by way of example):

BRAVO 17 R. Exxxx/BMyyyyyy LANGUAGE ENGLISH					DATE dd/mm/yyyy TIME hh:mm:ss				
			SETUP					SETUP	

Firmware version

Use the keys + / - to scroll through the menu.

1st PRESET				
134 POROUS / WRAPPED STANDARD DRYING				
			SETUP	

2nd PRESET				
134 HOLLOW / UNWRAP. FAST DRYING				
			SETUP	

Use the keys + / - to scroll through the menu.

3rd PRESET				
134 SOLID / WRAPPED EXTRA DRYING +05				
			SETUP	

4th PRESET				
134 EMERGENCY FAST DRYING				
			SETUP	

Use the keys + / - to scroll through the menu.

Stand-by option				
HIGH 120 min				
			SETUP	

Print option				
OFF 1 COPY(ies)				
			SETUP	

Use the keys + / - to scroll through the menu.

Filling option				
AUTOMATIC				
Drain option				
INTERNAL				
			SETUP	

Use the keys + / - to scroll through the menu.

EXIT				
DATA REVIEW				
↓ to continue				
			SETUP	

Press ↓ to confirm

NOTE	
	TO LEARN MORE ABOUT ANY OF THE TERMS ABOVE, SEE CHAPTER 6 - CONFIGURATION - CONFIGURATION OPTIONS.

6. CONFIGURATION

DEFAULTS SETTINGS

The sterilizer leaves the factory with the following settings:

PROGRAMS: Preset 1: **134 POROUS/WRAPPED**
 Preset 2: **134 HOLLOW/UNWRAP**
 Preset 3: **134 SOLID/WRAPPED**
 Preset 4: **134 SOLID/UNWRAP**

STAND-BY MODE: **HIGH** (preheating)
PRINT OPTIONS: **OFF or 1 copy**
FILLING OPTIONS: **MANUAL**
DRAIN OPTIONS: **INTERNAL**

CONFIGURATION OPTIONS

Setting the language
 (LANGUAGE on the BASIC Menu)

To configure the unit access the SETUP mode from the stand-by screen, enter the **SETUP** mode by holding down the \uparrow key on the control panel for several seconds until the SETUP screen appears (shown below).

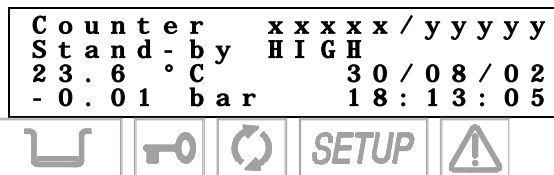

Scroll to the BASIC menu and press the \downarrow key. From here, scroll and select any of the following configuration options.

Select **LANGUAGE** using the \downarrow key. The following screen will appear:

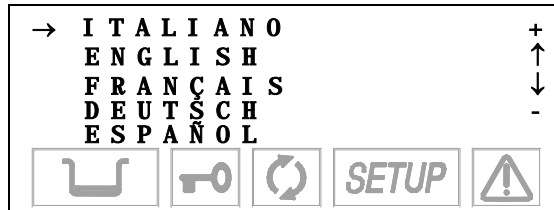

Select the desired language. Move using the + or – keys and confirm using the \downarrow key to store the selection. After the data is confirmed, return to the second-level menu.

NOTE

 **AS SOON AS THE SELECTION IS CONFIRMED, ALL THE MENUS OF THE SETUP PROGRAM WILL BE DISPLAYED IN THE LANGUAGE SET.**

Setting the date
 (DATE SETTING on the BASIC Menu)

When **DATE SETTING** is selected with the \downarrow key, you will see:

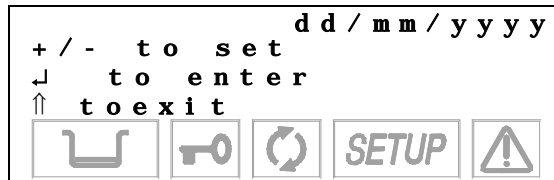

Setting the time (TIME SETTING on the BASIC menu)

To set the date, follow these steps:

- When the day flashes: set the current date with the + and - keys. Confirm with ↵.
- When the month flashes: set the current month with the + and - keys. Confirm with ↵.
- When the year flashes: set the current year with the + and - keys. Confirm with ↵.

The date is stored. Once the last confirmation is given, you return to the second-level menu.

When **TIME SETTING** is selected with the ↵ key, you will see:

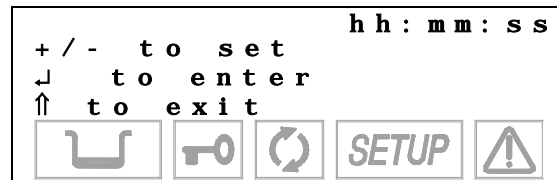

Follow these steps:

- When the hours **flash**: set the current hour with the + and - keys. Confirm with ↵.
- When the minutes **flash**: set the current value with the + and - keys. Confirm with ↵.

When the last confirmation is given, return to the second-level menu.

Setting the password (PASSWORD on the BASIC menu)

When **PASSWORD** is selected with the ↵ key, you will see this menu:

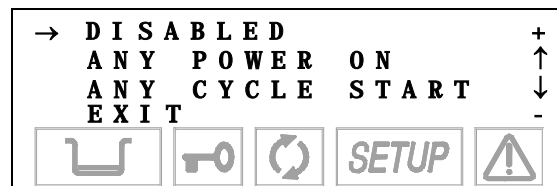

Select **DISABLED** to use the device freely, without limiting operator access.

Select **ANY POWER-ON** to password protect the main power switch. This allows only authorized personnel to turn the unit on. Once it is on, it can be used by any operator.

Select **ANY CYCLE START** to password protect the unit both at power-on and at the start of every sterilization program. In this mode, only authorized personnel will be able to use it. When the **ANY POWER-ON** or **ANY CYCLE START** options are selected, the following screen is displayed:



Enter the password with the + and – keys (fixed length, 8 characters). Confirm with the ↵ key. Then, the following message will appear:



Enter the password again using the + and – keys. Confirm with the ↵ key.

NOTE

 **TO CHANGE THE PASSWORD, FIRST SELECT THE DISABLE OPTION, WHICH CANCELS THE PREVIOUS PASSWORD, AND THEN SELECT THE ANY POWER-ON OR ANY CYCLE START OPTION, ENTERING THE NEW PASSWORD AS DESCRIBED ABOVE.**

Setting the sterilization programs
(PROGRAMS on the ADVANCED menu)





Setting and storing customized sterilization programs in the four pre-set positions can be completed by following these steps, starting in the advanced menu.
Each pre-set position can be associated to a **standard** or user configurable cycle (**CUSTOM**).

To associate a **standard program** and define several of its parameters, proceed as follows:

1. Select **PROGRAMS** using the ↵ key; the following menu appears:

```

→ 1 s t  P R E S E T      +
   2 n d  P R E S E T      ↑
   3 r d  P R E S E T      ↓
   4 t h  P R E S E T      -
   E X I T
    
```







SETUP

Define the position (1, 2, 3 or 4) to which the sterilization program will be associated using the + and - keys. Confirm with the ↵ key.

2. From here, you enter the list of available cycles:

```

→ 1 3 4  H O L L O W / U N W R A P .  +
   1 2 1  H O L L O W / U N W R A P .  ↑
   1 3 4  S O L I D / U N W R A P .    ↓
   1 2 1  S O L I D / U N W R A P .    -
   1 3 4  E M E R G E N C Y
   1 3 4  S O L I D / W R A P P E D
   1 2 1  S O L I D / W R A P P E D
   1 3 4  P O R O U S / W R A P P E D
   1 2 1  P O R O U S / W R A P P E D
   X X X  C U S T O M
   E X I T
    
```





SETUP

Using the + and - keys, scroll the list until you identify the sterilization program desired.

3. Confirm the selection with the ↵ key.

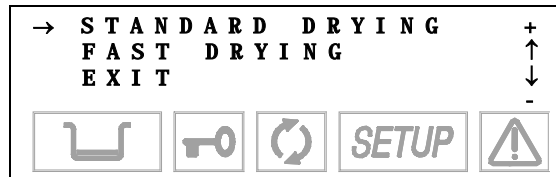
As a function of the choices made, you will go to one of two alternative menus that allow you to choose the type of drying you want associated with the selected program.

a) Programs with short drying (HOLLOW/UNWRAP., SOLID/UNWRAP., EMERGENCY):



The default setting is STANDARD mode. Move using the + and - keys and confirm with the ↵ key.

NOTE

THE EMERGENCY PROGRAM PROVIDES ONLY FAST DRYING (SUITABLE FOR A LOAD UP TO 0.5 KG/1.1 LBS).

b) Programs with long drying (POROUS/WAPPED, SOLID/WAPPED, EXTRA):



The default setting is **STANDARD**. Also available are the **INTELLIGENT** option, an automatic drying that adjusts its duration on the basis of the volume and/or quantity and type of load, and the **EXTRA** option, a selectable value extended drying recommended for critical loads. Move using the + and - keys and confirm with the ↵ key.

WARNING

THE FAST, INTELLIGENT AND EXTRA DRYING OPTIONS HAVE NOT BEEN VALIDATED AND HAVE NOT BEEN CLEARED IN THE U.S. BY FDA FOR HEALTHCARE USE.

PLEASE REFER TO THE “PROGRAM SUMMARY TABLE” AND ITS GENERAL NOTES (SEE APPENDIX B – PROGRAMS) FOR A DESCRIPTION OF THE DRYING OPTIONS AND THE MAXIMUM STERILIZABLE MASS ALLOWED IN EACH STERILIZATION PROGRAM.

When the **EXTRA** option is activated, the following screen appears:

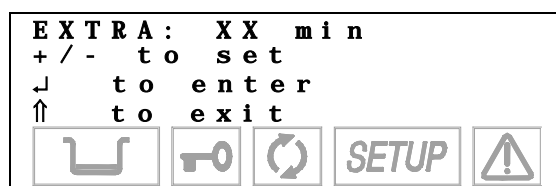

This option permits adding between **1** and **15** minutes of extra drying time to the STANDARD DRYING time). Set the value using the + and - keys and confirm the selection with the ↵ key.

NOTE

THE SELECTION CAN BE CHANGED AT ANY TIME BY FOLLOWING THE PROCEDURE DESCRIBED ABOVE.

WHEN AN IDENTICAL STERILIZATION PROGRAM IS ALREADY PRESENT IN ANOTHER POSITION, THE SELECTION IS NOT ACCEPTED. THE FOLLOWING WARNING APPEARS ON THE DISPLAY, ALONG WITH A BEEP:



6. CONFIGURATION

To define the **CUSTOM** program. follow these steps:

1. From the **PROGRAMS** menu, select the number to which the program is to be associated (see the previous description) and then select **CUSTOM** in the next screen. The following menu will appear:

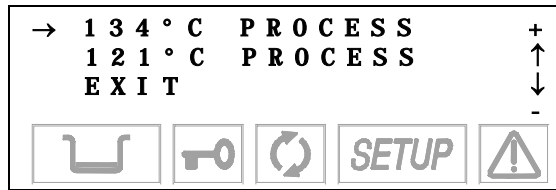

Select **121 °C** to perform a custom program with a sterilization process at **121 °C** or **134 °C** for one at **134 °C**. Move using the **+** and **-** keys and confirm with the **↵** key.

2. You will then go the screen:

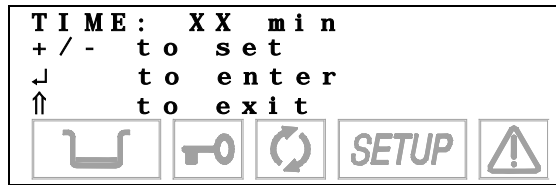

Use the **+** and **-** keys to set the duration of the sterilization process and confirm with the **↵** key.

NOTE

THE DURATION OF THE STERILIZATION PROCESS IS VARIABLE FROM 4 TO 30 MINUTES FOR THE PROGRAM AT 134 °C, AND FROM 20 TO 30 MINUTES FOR THE PROGRAM AT 121 °C.

3. After selecting the time, a new screen will ask you to specify the type of initial vacuum:

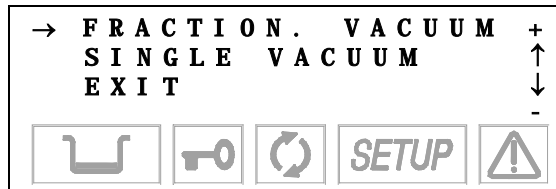

Select **FRACTION** to perform a fractionated vacuum (for hollow bodies and porous materials), or **SINGLE** for a single preliminary vacuum phase (for solid instruments). Move using the **+** and **-** keys and confirm with the **↵** key.

4. After selecting the vacuum, a new screen will ask you to set the drying mode:



Select **LONG** drying for porous and/or wrapped loads, or **SHORT** if you need to sterilize solid, loose materials (and even hollow, as long as it is not wrapped). Move with the **+** and **-**, confirm with the **↵** key.

5. Depending on the selection (**LONG** or **SHORT**) one of two different menus will open (these menus are the same for the standard cycles), i.e.:

In **SHORT** mode the following is displayed:



In **LONG** mode the following is displayed:

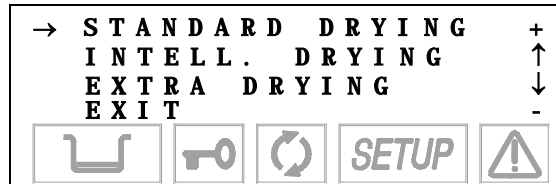

For the choice criteria, refer to instructions on page 27.

When the CUSTOM program is already present in another position, the selection is not accepted. The following warning appears on the display, along with a beep:



WARNING



CUSTOM PROGRAMS HAVE NOT BEEN VALIDATED AND HAVE NOT BEEN CLEARED IN THE U.S. BY FDA FOR HEALTHCARE USE. THEY SHOULD ONLY BE USED BY EXPERIENCED USERS.

PLEASE REFER TO THE "PROGRAM SUMMARY TABLE" AND ITS GENERAL NOTES (SEE APPENDIX B – PROGRAMS) FOR THE LIST OF AVAILABLE PROGRAMS, THEIR SCREENS AND THE CHARACTERISTICS OF STERILIZABLE MATERIALS (IN RELATION TO THE PROGRAMS).

NOTE



THE SELECTION CAN BE CHANGED AT ANY TIME BY FOLLOWING THE PROCEDURE DESCRIBED ABOVE.

ACCESS TO A CUSTOM CYCLE DOES NOT REQUIRE A PASSWORD.

NONE OF THE COMBINATIONS AVAILABLE IN THE CUSTOMIZATION PHASE CREATE ANY RISKS OR DANGERS OF INJURY TO THE OPERATOR OR DAMAGE TO THE DEVICE.

6. CONFIGURATION

Setting the STAND-BY mode

(STAND-BY OPTIONS on the ADVANCED menu)

Based on the equipment's frequency of use, or other considerations, users may want to select a high or low heating level during the STAND-BY (preheating) phase. They may also want to select a STAND-BY time-out mode that determines when the STAND-BY is deactivated. When you select **STAND-BY OPTIONS** with the ↵ key, you access the following menu:

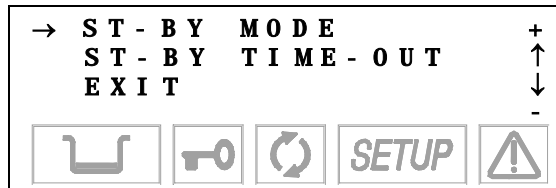

When you select **STAND-BY MODE**, an additional menu appears where you can set the heating level:



Select **HIGH** (high preheating level) to reduce the wait time between one cycle and the next.

Select **LOW** (low preheating) for normal use, since the wait time will be relatively shorter, in any case.

Select **OFF** (deactivate preheating) for occasional use. In this case, the wait time will be longer (up to about 10-12 minutes for a "cold start").

Move using the + and – keys, and confirm with the ↵ key.

On the other hand, when the **STAND-BY TIME-OUT** option is selected, it is possible to set the time for deactivating STAND-BY, i.e., how many minutes after the last cycle the heating elements are turned off.

The following screen appears:

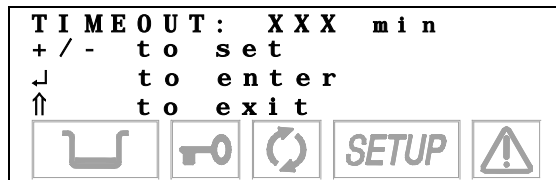

It is possible to set a value of between **0** and **300** minutes (in 30-minute increments), after which the heating elements are turned off (a condition similar to STAND-BY OFF), avoiding the useless consumption of electricity.

Set using the + and – key, and confirm with the ↵ key.

NOTE



THIS OPTION IS ALSO ACTIVE WITH **STAND-BY OFF**. HOWEVER, IN THIS CONDITION THE TIMER VALUE HAS NO EFFECT SINCE THE HEATING ELEMENTS ARE TURNED OFF ANYWAY AT THE END OF THE STERILIZATION PROGRAM.

WHEN ANY CYCLE SELECTION KEY (STERILIZATION OR TEST) IS PRESSED, OR THE MACHINE IS TURNED OFF AND ON WITH THE MAIN SWITCH, THE ORIGINAL **STAND-BY MODE (HIGH OR LOW)** IS IMMEDIATELY REACTIVATED.

Setting the printing mode

(PRINT OPTIONS on the ADVANCED menu)

When the sterilizer is equipped with a printer (optional on the Bravo17, but standard on the Bravo17V and 21V) for recording sterilization program data, it is necessary to set the parameters required for its proper operation.

1. Select **PRINT OPTIONS** using the ↓ key and the following menu appears:

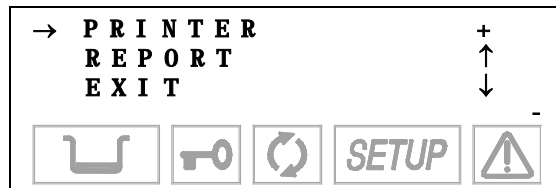

Select **PRINTER** to access the settings for the printer used, or **REPORT** to set the number of copies to print and to reprint data from the last program executed.

- a) Item **PRINTER**

The following screen appears:



Select **OFF** to deactivate the printing of data at the end of a sterilization (or test) cycle.

Select **INTERNAL** to enable the thermal printer set (option) inside the front of the sterilizer. In this case, another menu opens:

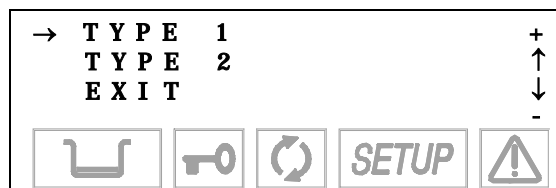

Select Type 1 for the model 1 of the printer installed.
Select Type 2 for the model 2 of the printer installed.

Printer model 1

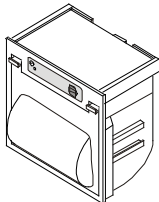

Printer model 2

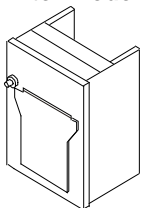

If, on the other hand, you choose **EXTERNAL**, the data will be printed on an external peripheral. Following this selection, another menu opens:

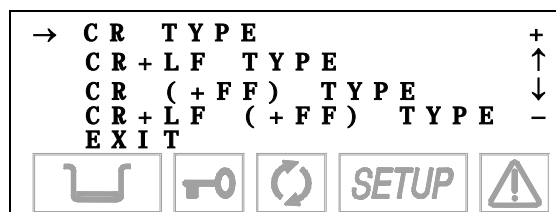

Activate **CR** to use printers that advance the paper only on the CR (*Carriage Return*) command, or **CR+LF** for those that require the CR+LF (*Carriage Return + Line Feed*) commands, or with **+FF** (Form-Feed) for printers that require the addition of this command.

NOTE



CONSULT THE PRINTER MANUAL TO DETERMINE THE TYPE OF COMMAND USED. IF THIS INFORMATION IS NOT AVAILABLE, TRY PRINTING WITH THE VARIOUS OPTIONS TO IDENTIFY THE CORRECT SETTING.

b) Item **REPORT**

The following screen appears:

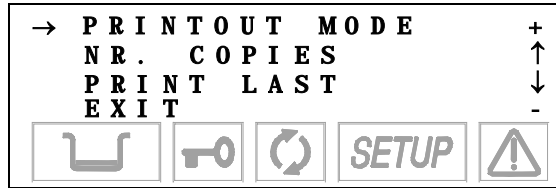

Select item **PRINTOUT MODE** to choose the mode in which the data is printed: The following options appear:

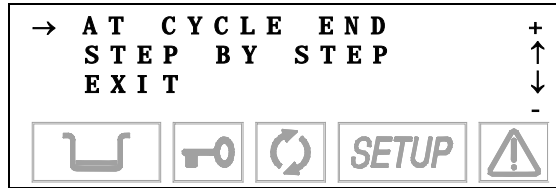

Select **AT CYCLE END** to print the report at the end of the cycle. Select **STEP BY STEP** to print the data at each phase of the cycle (see Examples of printed report in Appendix B).

NOTE

IT IS NOT POSSIBLE TO MAKE MULTIPLE COPIES OF REPORTS IN STEP BY STEP MODE.

THE VACUUM AND BOWIE & DICK TEST REPORT WILL ONLY PRINT OUT AT CYCLE END MODE.

Activate **NR. COPIES** to set the number of cycle report copies to print at the end of the program. The following text appears:

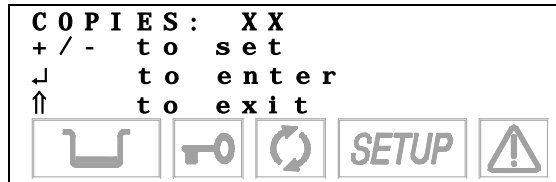

Set the number of copies desired (up to a maximum of 5). Confirm with the ↓ key.

To print a report from the last cycle executed (whether it terminated correctly or was interrupted by an alarm), select **PRINT LAST** . The following screen will appear:

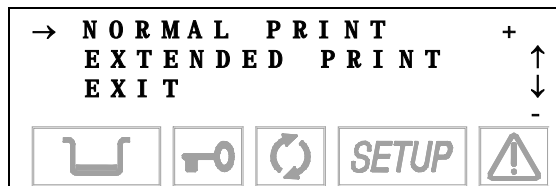

The **NORMAL PRINT** command activates normal printing (showing relevant cycle data and produced at the end of a correctly executed cycle), while **EXTENDED PRINT** activates a more complete print out (including all the data typical of a cycle interrupted by an alarm).

NOTE

 IF THE LAST CYCLE ENDED CORRECTLY OR WAS INTERRUPTED BY **MANUAL STOP**, IT IS POSSIBLE TO REPRINT THE REPORT IN EITHER **NORMAL** OR **EXTENDED** MODE. IF, HOWEVER, THE LAST CYCLE WAS INTERRUPTED BY AN ERROR AND CORRESPONDING ALARM, ONLY THE **EXTENDED** REPORT WILL BE AVAILABLE. THIS WILL FACILITATE LATER TROUBLESHOOTING.

When selecting the reprint command, this message will be displayed:

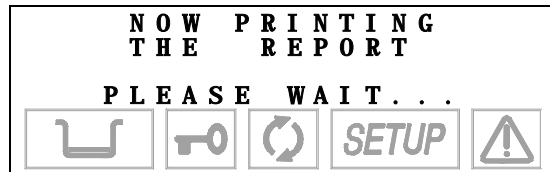

It will remain on the screen until the printing is complete.

Setting the tank filling mode
(FILLING OPTIONS on the ADVANCED menu)

The internal tank can be filled either manually or automatically. Automatic filling would occur from an external device (container or demineralizer) connected to the Bravo - see **Chapter 4 - Installation**).

Select **FILL OPTIONS** and the following menu appears:



When **AUTOMATIC FILL** is selected, the unit will automatically fill the internal tank until the maximum level (MAX signal) is reached and the MAX icon is displayed.

NOTE

 ONLY ACTIVATE THE AUTOMATIC FILLING MODE **AFTER** THE EXTERNAL TANK HAS BEEN FILLED WITH HIGH QUALITY DISTILLED WATER OR DEMINERALIZER. ALSO REMEMBER TO OPEN THE TAP ON THE EXTERNAL TANK OR DEMINERALIZER, IF REQUIRED.

When **MANUAL FILL** is selected, the internal tank must be filled manually (see Chapter 5 – Instructions for Use).

To scroll through the items, use the + and - keys, and make a selection with the ↵ key.

Setting the water draining mode
(DRAIN OPTIONS from the ADVANCED menu)

The water used for the sterilization cycle can be drained into either the **internal** tank (standard configuration) or the **external** SciCan tank of greater capacity (offered as an option – see Chapter 4 - Installation) so as to reduce the frequency of emptying the used water.

Select **DRAIN OPTIONS** and the following menu appears:



6. CONFIGURATION

Selecting **INTERNAL DRAIN** enables the reading of the MAX level sensor in the internal tank. This is the setting that should be selected if connected directly to the drain.

Selecting **EXTERNAL DRAIN** enables the MAX level sensor located in the external tank and in the internal tank.

NOTE

 THE LEVEL SENSOR IN THE INTERNAL TANK REMAINS ACTIVE IN EITHER MODE TO PREVENT A POSSIBLE MALFUNCTION OF THE EXTERNAL TANK OR A MISSING OR FAULTY CONNECTION OF THE OPTIONAL EXTERNAL DRAIN TANK. **IF THE INSTALLATION HAS CONNECTED DIRECTLY TO THE DRAIN, SELECT INTERNAL DRAIN.**

To scroll through the items, use the + and - keys, and make a selection with the ↵ key.





Acquisition of the ambient pressure
(AMBIENT PRESSURE on the SPECIAL menu)

The first time the sterilizer is used and after any reinstallation, the sterilizer must acquire the ambient pressure. This operation is **necessary** for the correct operation of several of the device's auxiliary systems.

When **AMBIENT PRESSURE** is activated, the following screen appears:

A C Q U I S I T I O N O F T H E
A M B I E N T P R E S S U R E

↵ t o e n t e r
↑ t o e x i t

NOTE

 CHECK THAT THE STERILIZER DOOR IS COMPLETELY **OPEN**. IF YOU TRY TO ACQUIRE THE PRESSURE WITH THE DOOR CLOSED THE FOLLOWING MESSAGE WILL BE DISPLAYED:

O P E N T H E D O O R
T O C O N T I N U E







and will remain until the door is opened.

Confirm the acquisition of the data by pressing the ↵ key. This message appears:

P R E S S U R E V A L U E
S E T I N T O M E M O R Y







accompanied by a beep to say that the ambient data pressure has been acquired.

Press the ↑ key to cancel the operation.

Adjusting the contrast of the liquid crystal display
(LCD CONTRAST on the SPECIAL menu)

The LCD contrast function adjusts the screens' readability to compensate for the sterilizer location's lighting.

When **LCD CONTRAST** is activated, this screen appears:

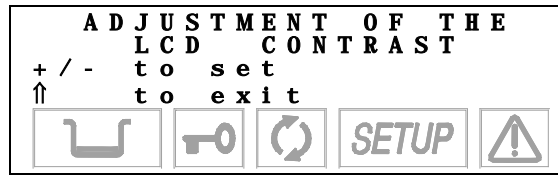

Press the + key to increase the contrast and the - key to reduce it.

Adjust the contrast until the display is as clear and readable as possible, based on the location's normal conditions.

EXIT THE CONFIGURATION MODE

When you have completed the sterilizer configuration, return to the normal mode by selecting **EXIT** and confirming with the ↓ key.

– This text will appear on the display:



After several seconds, the device returns to **normal operation** in **STAND-BY** mode.

NOTE



TO RETURN TO THE FIRST LEVEL FROM ANY MENU, JUST SELECT EXIT AND CONFIRM WITH THE ↓ KEY. YOU CAN ALSO PRESS ↑ (ESC) KEY ONE OR MORE TIMES.

7. PREPARING THE MATERIAL FOR STERILIZATION

7. PREPARING MATERIAL FOR STERILIZATION

Clean and rinse all instruments before loading them into the sterilizer. Disinfectant residues and solid debris may inhibit sterilization and damage the instruments and the Bravo.

Unwrapped instruments, once exposed to ambient or external conditions, cannot be maintained in a sterile state. If sterile storage is desired, wrap the instruments to be sterilized according to the instrument manufacturer's instructions, select the appropriate wrapped cycle and allow it to run to completion.

NOTE



USER SHOULD USE ONLY STERILIZATION WRAPS THAT HAVE BEEN CLEARED FOR THEIR MARKET. FOR U.S. CUSTOMERS, USE ONLY STERILIZATION WRAPS THAT HAVE BEEN CLEARED BY FDA FOR THE STERILIZATION PROGRAM CHOSEN.

To promote drying and enable effective sterilization, wrapped or pouched instruments must not touch each other.

SciCan recommends the final user carefully choose the most appropriate sterilization cycle according to the recommendations of their leading infection control authorities and local regulatory guidelines / recommendations.

WARNING



PLEASE REFER TO THE APPENDIX B - PROGRAMS (Introduction) FOR THE LIST OF COMPATIBLE MATERIALS WITH THE STERILIZER.

TREATING TEXTILE MATERIAL BEFORE STERILIZATION

With regards to **textile material** (or porous materials in general), such as smocks, napkins, caps and other, carefully wash and then dry these before they are treated in the autoclave.

NOTE



DO NOT USE DETERGENTS WITH A HIGH CONTENT OF CHLORINE AND/OR PHOSPHATES. DO NOT BLEACH WITH CHLORINE-BASED PRODUCTS. THESE SUBSTANCES CAN DAMAGE THE TRAY SUPPORTS, TRAYS AND ANY METAL INSTRUMENTS THAT MAY BE PRESENT IN THE STERILIZATION CHAMBER.

ARRANGING THE LOAD

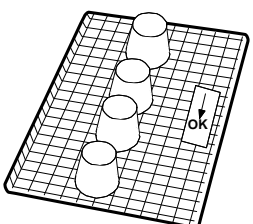
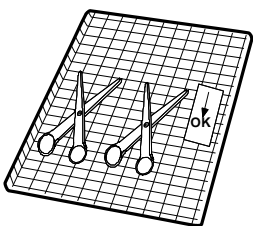

To ensure proper sterilization and to reduce wear on instruments, follow the instructions below:

General notes for positioning on trays.

- Arrange instruments made of different metals (stainless steel, tempered steel, aluminum, etc.) on different trays or keep them well separated from each other.
- For instruments **not** made of stainless steel, place a paper sterilization napkin or a muslin cloth between the tray and the tool to avoid direct contact between these two different materials.
- Always arrange objects with some distance between them and so that they will remain so for the entire sterilization cycle.
- Make sure that hinged instruments are sterilized in an open position.
- Position cutting instruments, (scissors, scalpels, etc.) such that they do not come into contact with each other during sterilization; if necessary, use a cotton or gauze cloth to isolate and protect them.
- Arrange receptacles (glasses, cups, test tubes, etc.) on their sides, or upside down to avoid pooling water.
- **Do not load trays beyond their maximum indicated limit (see [Appendix B](#)).**
- Do not stack trays or put them in direct contact with the walls of the sterilization chamber.
- Always use the tray support provided.
- To insert and remove trays from the sterilization chamber, always use the extractor provided.

NOTE



PROCESS THE APPROPRIATE BIOLOGICAL/CHEMICAL INDICATOR WITH EVERY TRAY TO CONFIRM STERILIZATION HAS OCCURRED. IF PROCESSING WRAPPED MATERIAL, PLACE THE INDICATOR INSIDE ONE OF THE WRAPPINGS. THE CUSTOMER SHOULD USE ONLY BIOLOGICAL INDICATORS THAT HAVE BEEN CLEARED IN THEIR MARKET. FOR U.S. CUSTOMERS, ONLY USE BIOLOGICAL INDICATORS THAT HAVE BEEN CLEARED BY FDA FOR THE STERILIZATION PROGRAM CHOSEN

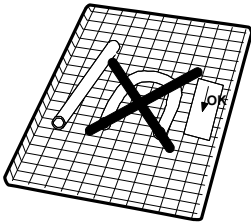

Notes for rubber and plastic tubing

- Always rinse tubing with clean water before use and do not dry them.
- Arrange the tubing on the tray so that their ends are not obstructed or crushed.
- Do not bend or wind tubes, but allow them to lie as straight as possible.

Notes for packets and packages

- Arrange packages side-by-side, evenly spaced and not piled, and do not allow them to come into contact with the walls of the chamber.
- When it is necessary to wrap an object, always use suitably porous material (sterilization paper, muslin napkins, etc.) and close the wrapping with autoclave adhesive tape.

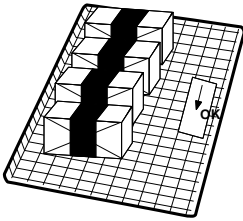

Notes for wrapped material

- It is best to wrap instruments individually, but if more than one instrument is placed in the same envelope, make sure that they are made of the same metal;
- Seal the wrapping with adhesive tape designed for autoclaves or heat-sealing machines.
- Do not use staples, pins or other fasteners since they can compromise the maintenance of sterility.
- Arrange the envelopes to avoid forming air pockets that obstruct the correct penetration and removal of the steam.
- Orient the envelopes with the plastic side up and the paper side down.
- Always check that envelopes are correctly positioned and turn them over if necessary.
- If possible, place the envelopes on their sides using a suitable support.
- If pouched or wrapped loads are not dry when they are removed from the chamber, the instruments must be used immediately or resterilized.

WARNING



IF YOU EXPECT TO STORE INSTRUMENTS, ALWAYS WRAP THEM. SEE THE CHAPTER 10 – STORING STERILIZED MATERIAL. THE USER SHOULD USE ONLY STERILIZATION WRAPS THAT HAVE BEEN CLEARED FOR THEIR MARKET. FOR U.S. CUSTOMERS, ONLY USE STERILIZATION WRAPS THAT HAVE BEEN CLEARED BY FDA FOR THE STERILIZATION PROGRAM CHOSEN.

**STERILIZATION
MONITORING**

Chemical process monitors suitable for steam sterilizers at the indicated cycle temperatures and times should be included in or on each package or load being sterilized. In addition, SciCan recommends the use of biological monitors such as the EZTEST-STEAM indicator or the 3M Attest system for routine monitoring of the sterilizer. It is important to select the correct biological indicator for the cycle being tested.

8. PROGRAM SELECTION

INTRODUCTION

Program selection is key to a successful sterilization process.

Since objects for sterilization can vary in shape, consistency and properties, it is important to identify the most suitable program for it. This will not only preserve its physical characteristics (avoiding or, at any rate, limiting alterations) it will ensure the most effective sterilization.

NOTE



A GUIDE TO SELECTING THE MOST SUITABLE PROGRAM FOR DIFFERENT LOAD TYPES IS PROVIDED IN APPENDIX B (PROGRAMS).

PROCEDURE

Power on the unit as described in the Chapter 5 – Instructions for Use.

NOTE



IF THE PASSWORD FUNCTION HAS BEEN ENABLED (SEE CHAPTER 6 - CONFIGURATION - SETTING THE PASSWORD), YOU WILL BE ASKED TO ENTER IT:

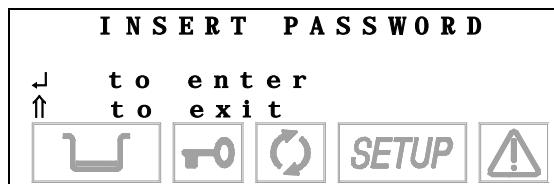

Enter the password using the + and – keys and confirm with the ↓ key.

At this point, the display will not offer any active pre-selection. It is waiting for the user to select a program.

Press the **PROGRAM SELECTION** key one or more times until you reach the desired program (1, 2, 3 or 4, also shown on the upper left of the display).

NOTE



WHEN THE SELECTION KEY IS PRESSED, THE FIRST STERILIZATION PROGRAM SHOWN IS THE ONE THAT WAS USED FOR THE LAST CYCLE EXECUTED.



The top two lines of the display show the description of the selected program and the type of drying set. Below are the set-point values for the temperature (°C), pressure (bar) and time (mm:ss) of the selected cycle. For example:

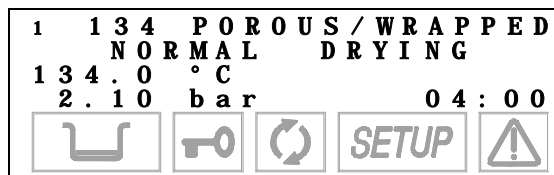

After a brief interval, the two lower lines of the display will change and show the present temperature and pressure values of the chamber, with the current date and time.

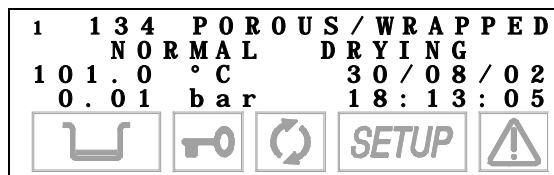

To cancel this selection, press ESC ↑ on the control panel.

NOTE



IF NO STERILIZATION PROGRAM IS SELECTED, THE EQUIPMENT CANNOT START A STERILIZATION CYCLE, AND THE FOLLOWING MESSAGE WILL APPEAR, WITH A BEEP:

S E L E C T A P R O G R A M
P L E A S E . . .



WARNING



IF YOU USE A PROGRAM THAT IS INAPPROPRIATE FOR THE TYPE OF MATERIAL TO BE STERILIZED (SEE APPENDIX B) THE EFFECTIVENESS OF THE STERILIZATION PROCESS IS NOT GUARANTEED.

9. RUNNING THE CYCLE

A sterilization cycle consists of a predetermined number of phases. Based on the type of air extraction, sterilization process and drying method, the number and duration of these phases can differ with each programs.

The electronic control system monitors the various phases, while checking that the various parameters are respected. If any type of anomaly is encountered during the cycle, the program is immediately interrupted, an alarm sounds and a code is displayed along with a message explaining the nature of the problem.

STARTING THE CYCLE

After placing the load in the sterilization chamber, select the desired program and close the door until you hear the click.

The door status icon  will flash to indicate the door is closed.

Press the **START** button.



Password check

NOTE

 IF THE PASSWORD FUNCTION HAS BEEN ENABLED (SEE CHAPTER 6 - CONFIGURATION - SETTING THE PASSWORD), YOU WILL BE ASKED TO ENTER IT:

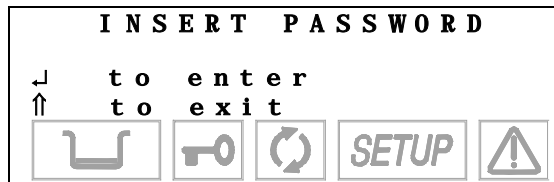

Enter the password using the + and – keys and confirm with the ↓ key.

The equipment will check for the presence of the paper in the on-board printer (if installed). If it is out of paper the following message will be displayed:

Printer paper-out check

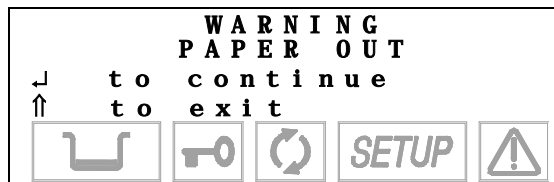

Push key ↓ to bypass, but remember to replace the paper during or at the end of the cycle). Push key ↑ to return in Stand-by mode.

The unit will may check for the presence of a data recording device or depending on the type of the device, the presence of a memory card inserted. If not plugged in, the display may shows:

If data recorder is connected



Ensure the data logger is properly connected and the proper memory card is installed then press the key ↓ on the command panel.

Push the key ↑ to interrupt the start command and return in Stand-by mode.

If there is insufficient memory to store the new cycle data, the following message will be displayed:

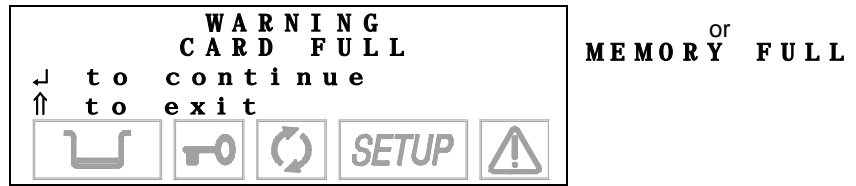

Push key ↓ to continue without recording the cycle data.
 Push key ↑ to interrupt the start command; download the files onto a PC and delete the memory content according to the instructions of the data recorder operating manual.
 Repeat the **Start** command.

The unit locks the door.

Door locking

When the door status icon  appears without blinking, the door is locked

When **START** is pushed, and for the entire sterilization cycle, the lower lines of the display will show the following parameters:

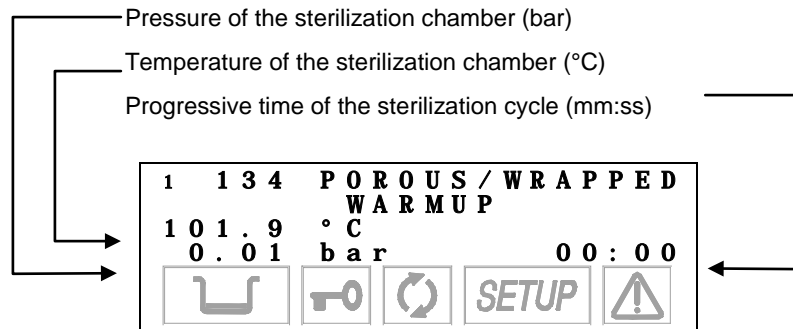

Cycle time is counted from the start of the sterilization cycle (at the first vacuum phase), and excludes the preheating phase.

PROGRAM EXECUTION

What follows is a phase by phase explanation of the execution of a sterilization cycle, using as an example, the most complete and important cycle, the **134 POROUS/WRAPPED** program. This cycle is characterized by a fractionated pre-vacuum.

Preheating

When the **START** button is pressed, the first phase is **PREHEATING**, which brings the chamber to the required temperature for the start of the cycle. The display shows the following:

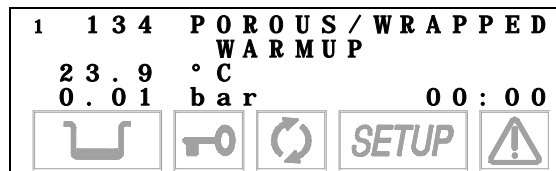

The icon that shows the status of the sterilization process  is off.

9. RUNNING THE CYCLE

First vacuum phase

When the optimum temperature is reached, the first vacuum phase (**1st VACUUM PULSE**) begins and the unit brings the chamber pressure down to the target value. The display shows:

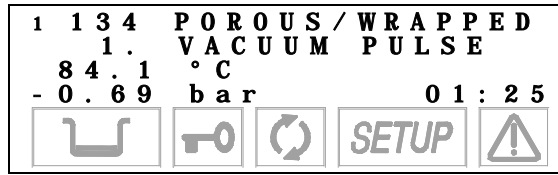

First rise in pressure

When the pre-set vacuum value is reached, steam is injected and the pressure begins to rise (**1st PRESSURE PULSE**), until the target value is reached.

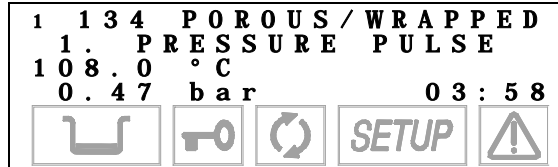

Second vacuum phase

At the end of the pressure rise, the steam, mixed with residual air, is discharged and the second emptying of the sterilization chamber begins (**2nd VACUUM PULSE**).

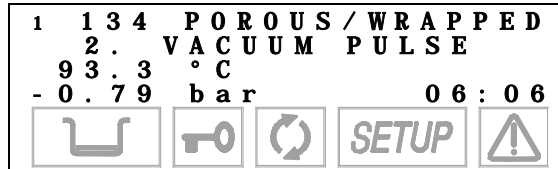

After the second vacuum phase, steam is again injected into the sterilization chamber, with a corresponding rise in pressure (**2nd PRESSURE PULSE**).

Second rise in pressure

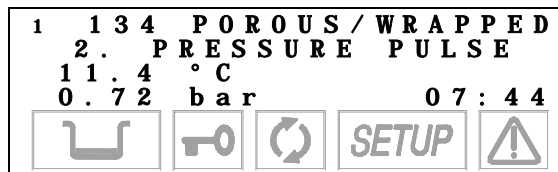

The icon that shows the status of the sterilization process  is always off.

At the end of the second pressure rise, there is another discharge and the last vacuum phase begins (**3rd VACUUM PULSE**).

Third vacuum phase

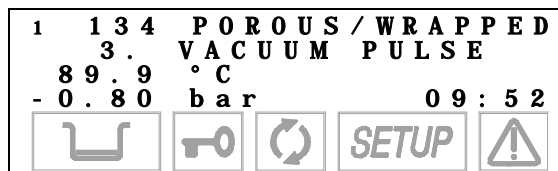

Third rise in pressure

After the last vacuum phase, the pressure in the sterilization chamber must rise to the value set for the sterilization process (**3rd PRESSURE PULSE**), always through the injection of steam.

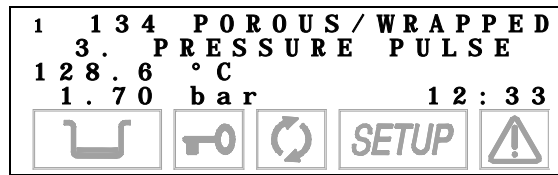

Thermodynamic equilibrium

When the pressure and temperature values for the selected program have been reached, the unit pauses to allow the temperature in the chamber to stabilize (**EQUILIBRATION**). The liquid crystal display shows:



When the thermodynamic parameters are balanced, the actual sterilization phase of the materials begins (**HOLDING TIME**).

Sterilization time

With continuous monitoring of the thermodynamic parameters and ongoing management of the plumbing circuit, the pressure and temperature are remain **constant** within the limits required by the program. A sterilization time countdown begins, and the display shows the following:

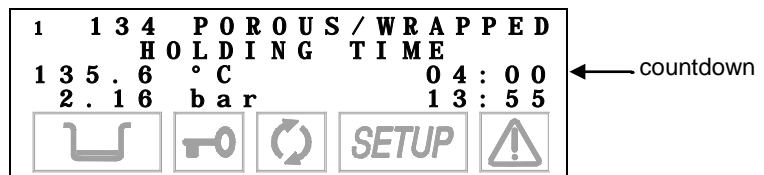

The icon for the sterilization process status  **flashes** to indicate that the treatment of the load is in progress.

At the end of the sterilization phase, the icon  stays on to indicate the complete sterilization of the material in the sterilization chamber.

WARNING

 **IF THE STERILIZATION CYCLE IS INTERRUPTED BEFORE COMPLETION, THE ICON WILL CONTINUE TO FLASH. WHEN THIS HAPPENS, THE MATERIAL CANNOT BE CONSIDERED STERILE AND MUST NOT BE USED.**

At the end of the sterilization phase, the steam is released from the sterilization chamber (**STEAM DISCHARGE**). The liquid crystal display shows:

Steam discharge



The icon for the sterilization process status  stays **on**.

9. RUNNING THE CYCLE

Drying

After the steam under pressure is released, the vacuum pump turns on to begin the drying phase (**DRYING**). This creates a low pressure in the sterilization chamber to facilitate the evaporation and consequent elimination of the steam. Depending on the type of drying selected, one of the following screens will appear:

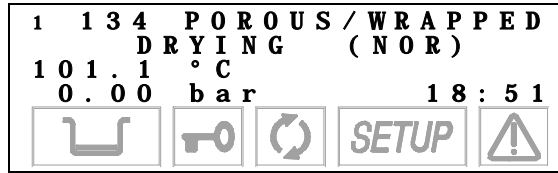

Standard drying

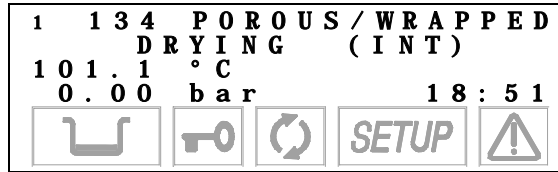

Intelligent drying

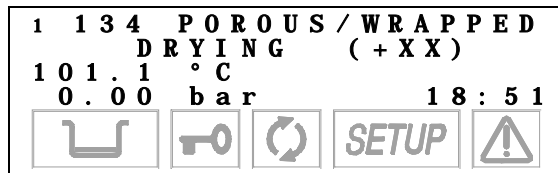

EXTRA DRYING
(+XX) is the time set

When the drying phase is complete, it is followed by a **VENTILATION** phase in which sterile, fresh air is injected, while maintaining a vacuum in the chamber, to eliminate condensate and cool the load.

Ventilation

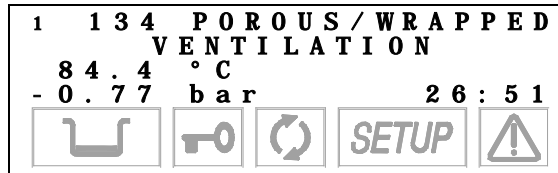

At the end of the ventilation phase, the chamber is brought back to atmospheric pressure (**LEVELLING**) by injecting sterile outside air to allow the opening of the door and the retrieval of the load.

Leveling to the atmospheric pressure



When the drying cycle is completed and the chamber pressure returns to pre-set safety limits, the door status indicator  will **flash, the unit will beep and the** door will unlock.

Completion of the cycle

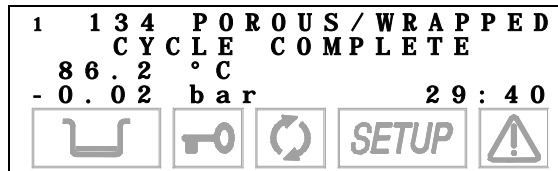

The icon for the sterilization process status  stays on.

NOTE

 AT THE END OF THE CYCLE, AND UP TO THE OPENING OF THE DOOR, THE HEATING ELEMENTS ARE OFF TO ALLOW COOLING OF THE LOAD. ONLY AFTER THE LOAD HAS BEEN REMOVED WILL THE UNIT RETURN TO ANY STAND-BY PREHEATING OPTIONS YOU HAVE SELECTED.

NOTE

 WHEN THE STERILIZER'S DOOR IS NOT OPENED AT THE END OF THE CYCLE, THE VACUUM PUMP IS PERIODICALLY ACTIVATED TO REMOVE ANY TRACES OF CONDENSATE FROM THE STERILIZATION CHAMBER. THE DISPLAY SHOWS:

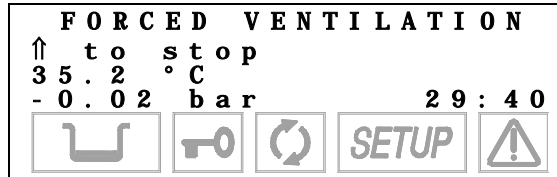

Press  to interrupt ventilation and open the door.

Open the door

Open the door and retrieve the sterilized material, using the extractor provided.

When the door is opened, the icon  symbol turns off and the device goes to STAND-BY mode as previously set.

Report print (option)

When the door is opened, the report for the sterilization cycle executed is automatically produced (if the printer or data logger is installed). Refer to the print report examples shown in Appendix B, Programs.

If a data logger is installed, never remove the USB stick until the report is fully downloaded, which is indicated by a quick flashing light on the USB stick and a message on the LCD display.

Equipment ready

NOTE

 IF THE PRINTOUT **STEP BY STEP** OPTION IS SELECTED, THE REPORT WILL BE PRINTED AT THE COMPLETION OF EACH PHASE OF THE CYCLE.

The device is **ready** to execute a **new cycle**. Repeat the procedures explained in the Chapter 8 - Program Selection to execute a new sterilization cycle.

RESULT OF THE CYCLE

After the cycle is finished, it is important to check the sterilization results.

The report (option) of the sterilization parameters is an additional verification tool.

9. RUNNING THE CYCLE

CHECKING THE CYCLE DATA REPORT (FOR UNITS WITH PRINTERS)

It is a good practice to check that the print report issued at the end of the sterilization program, also specifies a positive outcome.

At the end of the cycle, the relevant data for the thermodynamic parameters of the sterilization, i.e., temperature and pressure (°C and bar), and time (in minutes) of the sterilization cycle, along with particular attention to the sterilization phase, will print automatically when the door is opened.

Check the values on the print report and any additional indications for further confirmation of sterilization.

The operator should sign in the space provided and file the document for possible future use.

If necessary, copies of the document can be used to identify the load (or parts of it) with the date/time of sterilization and details of the type of cycle performed.

To select the number of copies to print, consult **Chapter 6 - Configuration**.







NOTE

 THE OPERATOR CAN ALSO REQUEST AN EXTENDED PRINTOUT OF THE STERILIZATION PROCESS DATA, INCLUDING THE RECORDED VALUES OF ALL THE SENSORS INSTALLED ON THE MACHINE. TO START THIS PRINT FUNCTION, HOLD DOWN THE ↑ (ESC) KEY ON THE CONTROL PANEL WHILE OPENING THE DOOR. FOR COMPLETE DETAILS ABOUT PRINTING THE SUMMARY, PLEASE REFER TO THE REPORT EXAMPLES SHOWN IN APPENDIX B, PROGRAMS.

MANUAL CYCLE INTERRUPTION





The operator can manually interrupt the cycle at any time by pressing the START/STOP key for three seconds. This command generates the error **E999**, because the cycle did not finish correctly. Until it is safe to open the door, the unit will beep and the display will show:



MANUAL STOP				
LEVELLING . . .				
1 0 1 . 2	° C	E 9 9 9		
- 0 . 4 7	b a r	2 6 : 0 1		
			SETUP	

← Error code

When safe conditions are reached, the machine activates a special procedure, first asking the user to manually unlock the door by displaying the following instruction:

PRESS ↑ TO				
UNLOCK THE DOOR				
8 6 . 2	° C	E 9 9 9		
- 0 . 0 2	b a r	2 6 : 0 1		
			SETUP	

Press the ↑ key to unlock the door.
The following message is then displayed:



MANUAL STOP				
OPEN THE DOOR				
8 5 . 8	° C	E 9 9 9		
- 0 . 0 1	b a r	2 6 : 0 1		
			SETUP	

Finally, when the door is opened, you will be asked to **reset** the device by the following message:



RESETTING THE SYSTEM



To **RESET** the system, press and hold the **PROGRAM SELECTION** key for at least three seconds until you hear the confirmation beep.

When the door is opened, the report for the sterilization cycle executed is produced, including the error code (**E999**). Check the report, initial it in the space provided and file it in a suitable place.

For more information, refer to the print report examples shown in **Appendix B, Programs**.

After the **RESET**, the device goes into **STAND-BY** mode, ready to execute a new program.



NOTE

 **WHEN AN ALARM IS GENERATED AT CERTAIN PHASES OF THE CYCLE, AN AUTOMATIC PROCEDURE IS ACTIVATED TO CLEAN THE PLUMBING CIRCUIT. FOR A COMPLETE DESCRIPTION OF THE ALARMS, SEE APPENDIX E - ALARMS.**

NOTE

 **AFTER AN ABORTED CYCLE, DUE TO A BLACK-OUT OR A POWER FAILURE, THE USER CANNOT ACCESS THE CHAMBER UNTIL TO THE POWER RETURNS. AT THAT TIME, THE USER MUST RESET THE UNIT ACCORDING TO THE PROCEDURE DESCRIBED IN THE APPENDIX E – ALARMS (ALARM INTERVENTION). AT THE START OF THE NEXT CYCLE, AN AUTOMATIC PROCEDURE IS ACTIVATED TO CLEAN THE PLUMBING CIRCUIT. FOR A COMPLETE DESCRIPTION OF THE ALARMS, SEE APPENDIX E - ALARMS.**

WARNING

 **IF THE ICON  IS OFF, THE MATERIAL IN THE STERILIZATION CHAMBER CANNOT BE CONSIDERED STERILE AND MUST NOT BE USED.**

10. STORING STERILIZED MATERIALS

10. STORING STERILIZED MATERIALS

INTRODUCTION

The sterilized material must be adequately treated and stored to maintain its sterility over time, until its use.

Inadequate storage can cause rapid recontamination.

This leads to problems regardless of what you do since you will either be using recontaminated material (most of the time unconsciously), placing the user and patient at risk, or you will have to run the sterilization cycle again, with an inevitable waste of time and resources.

For this reason, we think it will be useful to provide several basic suggestions, leaving the operator the task of further study of specific texts.

HANDLING

Assuming that the sterilizer is located in a clean place, free of dust and not too damp, the following **precautions** should be taken when handling and/or carrying sterile material:

1. Remove the load from the sterilization chamber wearing gloves and a clean, or even better, sterilized smock. As an additional precaution, wear a protective mask on your face;
2. Rest the tray on a dry, suitably clean and disinfected surface. *Take care to distance or, at any rate, separate the sterile material from the area where contaminated material is kept waiting to be sterilized;*
3. Touch the material and/or instruments as little as possible, taking extreme care **not** to cut or damage the wrappings;
4. Let the instruments cool before any transport (and subsequent storage). If necessary for transport, transfer the material using dry, clean and disinfected containers. The containers must be closed or, if open, covered with clean cloths.

STORAGE

Sterile material waiting for used must be stored using the appropriate techniques. These will significantly **slow** recontamination:

1. Store the material and/or instruments in the protective wrappings that were used during sterilization. **Do not** wrap the instruments after sterilization since, in addition to being useless and completely senseless, is also potentially damaging;
2. Store the material in a dry, suitably clean and disinfected place, far from the area where infected material passes. If possible, use closed compartments equipped with ultraviolet light;
3. Identify the sterile material by attaching the sterilization data (attaching a copy of the printed report or an adhesive label);
4. First use the material that has been stored the longest (FIFO, "First In First Out"). This results in material that is homogeneously stored, avoiding storing for too long, with the consequent risks.
5. **Never** store material for too long. In fact, do not overlook the fact that materials will tend to degrade and be recontaminated in a finite time, even when the above instructions are followed.

NOTE



UNPACKAGED INSTRUMENTS AND MATERIALS MUST BE STORED IN A CLOSED, DRY, CLEAN AND DISINFECTED PLACE, POSSIBLY EQUIPPED WITH ULTRAVIOLET LIGHT.

PLEASE REMEMBER THAT UNPACKAGED INSTRUMENTS AND/OR MATERIALS ARE NOT SUITABLE FOR LONG TIME STORAGE. IT IS RECOMMENDED THEIR IMMEDIATE USE AFTER THE STERILIZATION PROCESS.

WARNING



CONSULT THE SPECIFICATIONS PROVIDED BY THE MANUFACTURER OF THE PACKAGING MATERIAL FOR INFORMATION ON THE MAXIMUM ALLOWED STORAGE TIME.

11. TEST PROGRAMS

INTRODUCTION

The Bravo product line offers two test programs to periodically check the unit's effectiveness. The two programs are:

- BOWIE & DICK Test
- Vacuum Test

The **BOWIE & DICK Test** program executes a cycle at 134 °C for a duration of 3.5 min. This cycle has a fractionated vacuum phase similar to that used in the POROUS and HOLLOW programs. Using a suitable test pack, it is possible to evaluate the correct penetration of the steam inside porous loads (see the following paragraph).

The **Vacuum Test** program tests the seal of the sterilizer's entire plumbing system. By measuring the variation in the degree of vacuum in a certain span of time and comparing it with pre-set limit values, it is possible to determine the effectiveness of the seal of the sterilization chamber, the various tubes and the cut-off devices.

BOWIE & DICK TEST



To select the **BOWIE & DICK Test** program, press the **Test Selection** key one or two times until the display reads:



The test device is a **Bowie & Dick** test pack, manufactured according to the applicable standards. To execute the test, insert the **Bowie & Dick** test pack in the chamber.

NOTE



THE DEVICE AND CHEMICAL INDICATORS FOR RUNNING THE **BOWIE & DICK TEST** PROGRAM ARE NOT SUPPLIED WITH THE DEVICE. TO REQUEST INFORMATION IN THIS REGARD, CONTACT **SciCAN'S CUSTOMER SUPPORT DEPARTMENT (SEE APPENDIX Z)**.

Place the test pack horizontally on the device's lowest tray, in the front part of the chamber, near the door. **Do not** put any other material inside the chamber.

Close the door and start the program by pressing the **START** key.

NOTE



IN ADDITION, THE UNIT CHECKS THE PRESENCE OF PRINTER PAPER (IF PRINTER EQUIPPED) AND, IF A DATA RECORDER IS CONNECTED, THE PRESENCE OF THE FLASH CARD AND ITS MEMORY CAPACITY.

THE POSSIBLE WARNING MESSAGES, AND THE CONSEQUENT ACTIONS TO CARRY OUT, ARE THE SAME AS DESCRIBED FOR A STANDARD STERILIZATION CYCLE.

NOTE



FOLLOW THE INSTRUCTIONS PROVIDED BY THE INDICATOR'S MANUFACTURER FOR ITS METHODS OF USE, INDICATION AND ANY OTHER TECHNICAL DETAILS.

As the door is opened at the end of the cycle, a report will be printed providing relevant data for the test cycle performed (if the printer is installed).

For complete details about printing summaries, please refer to the report examples shown in **Appendix B, Programs**.

VACUUM TEST



To select the **VACUUM TEST** program, press the **Test Selection** key one or two times until the display reads:

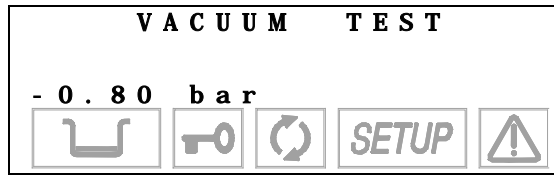

The Vacuum Test program is run with the sterilization chamber empty, except for the trays and their supports.

NOTE

RUN THE VACUUM TEST AS THE FIRST CYCLE AFTER POWERING-ON THE EQUIPMENT.

To avoid the heating of the sterilization chamber influencing the variation of the vacuum value measured during the Vacuum Test, the system is programmed to prevent running this test when the temperature sensors of the sterilization chamber show a value higher than 50° C.

If you try to start the program with a higher temperature than indicated above, the display will read:



After a short time, the device will automatically return to STAND-BY mode, ready for use.

NOTE

TO RAPIDLY LOWER THE TEMPERATURE OF THE CHAMBER LEAVE THE STERILIZER'S DOOR OPEN UNTIL THE CORRECT TEMPERATURE IS REACHED.

Close the door and start the program with the **START** key.

NOTE

IN ADDITION, THE EQUIPMENT CHECKS THE PRINTER PAPER PRESENCE (OPTION) AND, IF A DATA RECORDER IS CONNECTED, THE PRESENCE OF THE FLASH CARD AND ITS MEMORY CAPACITY.

THE POSSIBLE WARNING MESSAGES, AND THE CONSEQUENT ACTIONS TO CARRY OUT, ARE THE SAME AS DESCRIBED FOR A STANDARD STERILIZATION CYCLE.

The vacuum phase will begin immediately and the display reads:

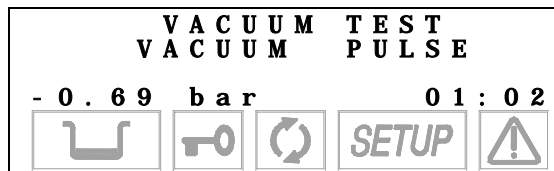

The display shows the pressure (**bar**), and the total time from the start of the program.

When the pre-set pressure is reached (**-0.80 bar**) the pump stops and the pressure stabilization phase begins (**WAITING PERIOD**). This lasts 5 minutes is shown on the display:

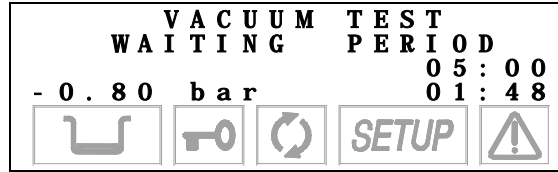

During this phase, a variation of not more than 10% of the maximum low pressure is allowed. Beyond this, the test will fail.

When the waiting phase is complete, the pressure verification phase begins (**LEAKAGE PERIOD**). This will last 10 minutes:

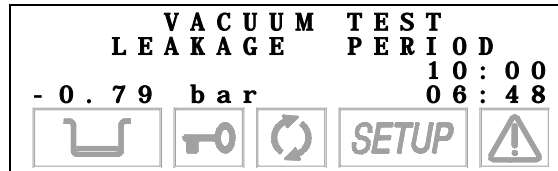

In this phase, a variation of **up to ±0.02 bar** is allowed, compared to the initial phase value. Higher variations, however, will cause the test to fail. The time is counted down until the phase is completed, after which the pressure is brought back to atmospheric pressure.



When the program finishes, the display will read:



The end of the program is signaled with a beep.

NOTE

 **IF THE PRESSURE CHANGE EXCEEDS THE PRE-SET LIMIT, THE PROGRAM IS INTERRUPTED AND ALARM MESSAGE IS GENERATED. SEE A COMPLETE DESCRIPTION OF THE ALARMS IN APPENDIX E.**

When the door is opened at the end of the program, a report of the test cycle is printed (if the printer is installed) with all the salient data.

For complete details about printed reports, please refer to the examples shown in **Appendix B, Programs**.

APPENDIX A – TECHNICAL CHARACTERISTICS

SUMMARY TABLE

Device		Autoclave		
Models		Bravo ¹⁷ , Bravo ^{17V} , Bravo ^{21V}		
Manufacturer		SciCan Ltd. 1440 Don Mills Road Phone: (416) 445-1600 Toronto ON M3B 3P9 Fax: (416) 445-2727 CANADA Toll free: 1-800-667-7733		
Power supply (see identification plate on the device)		120V, 60 Hz	220/230V, 60Hz	220/240V, 50Hz
Nominal power		1700 W (15A)	2300 W (10A)	2300 W (10A)
Mains fuses (6.3 x 32 mm)		F 15A	F 15A	F 15A
On-board fuses 5 x 20 mm	F1 (Secondary trafo):	T 5A 250V	T 5A 250V	T 5A 250V
	F2 (Primary trafo):	T 4A 250V	TT 2A 250V	TT 2A 250V
	F3 (doorlock accidental activation):	F 200mA 250V	F 200mA 250V	F 200mA 250V
	F4 (doorlock overload):	F 1.25A 250V	F 1.25A 250V	F 1.25A 250V
	F1 PTR (printer protection):	T 5A 250V	T 5A 250V	T 5A 250V
External dimensions (LxDxH) (excluding rear connections)		Bravo ¹⁷ , Bravo ^{17V} : 480 x 560 x 420 mm / 18.9" x 22.04" x 16.5" Bravo ^{21V} : 480 x 660 x 420 mm / 18.9" x 25.98" x 16.5"		
Insulation class		Class I		
Installation category		Cat. II		
Environment of use		Internal use		
Noise level		<60 db(A)		
Environmental operating conditions		Temperature Rating:: +15 °C to +40 °C Relative humidity: max 80%, non-condensing Altitude: max 3000 m (a.s.l.)		
Net weights		Bravo ¹⁷ : ~ 50 kg / 110 lbs (empty) ~ 55 kg / 121 lbs (empty with trays and support) ~ 59 kg / 130 lbs (empty with trays, supports, MAX water) Bravo ^{17V} : ~ 53 kg / 117 lbs (empty) ~ 58 kg / 128 lbs (empty with trays and support) ~ 62 kg / 137 lbs (empty with trays, supports, MAX water) Bravo ^{21V} : ~ 58 kg / 128 lbs (empty) ~ 63 kg / 139 lbs (empty with trays and support) ~ 67 kg / 148 lbs (empty with trays, supports, MAX water)		
Sterilization chamber dimensions (Diameter x Length)		Bravo ¹⁷ , Bravo ^{17V} : D250 x L343 mm / D10" x L13.5" Bravo ^{21V} : D250 x L445 mm / D10" x L17.5"		
Sterilization chamber total volume		Bravo ¹⁷ , Bravo ^{17V} : ~ 17 L (0.017 m ³ / 0.60 ft ³) Bravo ^{21V} : ~ 21 L (0.021 m ³ / 0.74 ft ³)		
Distilled water tank capacity (supply)		~ 4.6 L / 1.22 US gal (water at MAX level) ~ 0.8 L / 0.02 US gal (water at MIN level)		
Sterilization programs		Available: 10 (see Appendix B) Pre-sets: 4 (direct selection by user)		
Test programs		BOWIE & DICK Test, Vacuum Test		
Preheating time (from cold)		~ 10 minutes		
Serial connection		DB-9 pin (female) connector		
Bacteriological filter (PTFE filtering element)		Porosity: 0.2 µm Connection: male 1/8" NPT connector		

SAFETY DEVICES

The sterilizer is equipped with the following safety devices:

- **Mains fuses** (see summary table data)
Protects inside the device against a fault in the heating elements.
Action: cuts the electricity.
- **Fuses protecting the electronic circuits** (see summary table data)
Protects against a fault in the primary transformer circuit and low voltage uses.
Action: cuts power to one or more low-voltage circuits.
- **Thermal circuit breakers on the mains voltage windings**
Protects against overheating of the vacuum pump motor and the primary transformer windings.
Action: temporary cut-off (until cooling) of the winding.
- **Safety valve**
Protects against overpressure in the sterilization chamber.
Action: releases the steam and restores to a safe pressure.
- **Steam generator manual re-arm safety thermostat**
Protects against steam generator overheating.
Action: cuts-off the electricity to the steam generator.
- **Heating element manual re-arm safety thermostat**
Protects against overheating of the heating elements of the container under pressure.
Action: cuts-off the electricity to the chamber heating element.
- **Door position safety microswitch**
Confirms the door is correctly closed when the container is under pressure.
Action: signals incorrect door position.
- **Mechanized door lock mechanism with electromechanical protection (pressure switch)**
Protects against accidental opening of the door (even in a blackout).
Action: locks the door.
- **Door lock mechanism safety microswitch**
Confirms the door lock is operating correctly.
Action: signals the failure or incorrect operation of the door lock mechanism.
- **Self-leveling plumbing system**
Plumbing system structure that allows for the spontaneous leveling of pressure in the case of a manual interruption of the cycle, alarm or blackout.
Action: automatically restores atmospheric pressure in the sterilization chamber.
- **Integrated system for evaluating the sterilization process**
Provides continuous verification of the sterilization process parameters entirely managed by microprocessor.
Action: in case of anomaly, immediately interrupts the program and generates alarms.
- **Monitoring of the sterilizer's operation**
Provides real-time oversight of all significant parameters when the machine is on.
Action: in case of anomaly, generates alarm messages with possible interruption of the cycle.

WATER SUPPLY CHARACTERISTICS

DESCRIPTION	WATER SUPPLY VALUES	VALUES IN CONDENSATE
DRY RESIDUE	< 10 mg/l	< 1 mg/l
SILICON OXIDE SiO ₂	< 1 mg/l	< 0.1 mg/l
IRON	< 0.2 mg/l	< 0.1 mg/l
CADMIUM	< 0.005 mg/l	< 0.005 mg/l
LEAD	< 0.05 mg/l	< 0.05 mg/l
HEAVY METAL RESIDUES (except iron, cadmium and lead)	< 0.1 mg/l	< 0.1 mg/l
CHLORINES	< 2 mg/l	< 0.1 mg/l
PHOSPHATES	< 0.5 mg/l	< 0.1 mg/l
CONDUCTIVITY AT 20 °C	< 15 µs/cm	< 3 µs/cm
pH VALUE	5 - 7	5 - 7
APPEARANCE	colorless, transparent, without sediments	<i>colorless, transparent, without sediments</i>
HARDNESS	< 0.02 mmol/l	< 0.02 mmol/l

NOTE



WHEN PURCHASING DISTILLED WATER, ALWAYS CHECK THAT THE QUALITY AND CHARACTERISTICS DECLARED BY THE PRODUCER ARE COMPATIBLE WITH THOSE SHOWN IN THE TABLE.

WARNING



THE USE OF WATER CONTAINING CONTAMINANTS IN LEVELS EXCEEDING THOSE SHOWN IN THE TABLE WILL SIGNIFICANTLY SHORTEN THE STERILIZER'S LIFE. IN ADDITION, THIS MAY INCREASE THE OXIDATION OF MORE SENSITIVE MATERIALS AND INCREASE LIME RESIDUES ON THE GENERATOR, BOILER, INTERNAL SUPPORTS AND INSTRUMENTS.

APPENDIX B – PROGRAMS

INTRODUCTION

The steam sterilizer is appropriate for almost all materials and instruments, so long as they are able to tolerate, without damage, a **minimum temperature of 121 °C**.

The following material can typically be sterilized with steam:

- Stainless steel surgical/generic instruments;
- Carbon steel surgical/generic instruments;
- Rotating and/or vibrating instruments driven by compressed air (turbines) or mechanical transmission (counter-angles, tooth scalers);
- Glass articles;
- Mineral-based articles;
- Articles made of heat-resistant plastic;
- Articles made of heat-resistant rubber;
- Heat-resistant textiles;
- Medical textiles (gauze, pads, etc.);

NOTE



TO PREVENT THE INSTRUMENTS AND/OR MATERIALS FROM ELECTROLYTHIC CORROSION DURING THE STERILIZATION PROCESS, PLEASE **AVOID** DIRECT CONTACT BETWEEN THE FOLLOWING METALS:

ALUMINUM (AL) - NICKEL (Ni);
 CARBON STEEL – NICKEL (Ni);
 NICKEL (Ni) – CHROME (Cr);
 COPPER (Cu) – ALUMINUM (AL);
 CARBON STEEL – COPPER (Cu);
 CHROME (Cr) – COPPER (Cu);
 STAINLESS STEEL – ALUMINUM (AL);
 CARBON STEEL – STAINLESS STEEL;
 CHROME (Cr) – STAINLESS STEEL.

ALWAYS SEPARATE THE INSTRUMENTS AND/OR MATERIALS BY METAL TYPE AND ELECTROLYTHIC COMPATIBILITY.

NOTE



DEPENDING ON THE CONFORMATION OF THE MATERIAL (SOLID, HOLLOW OR POROUS), ANY PACKAGING (PAPER/PLASTIC ENVELOPE, STERILIZATION PAPER, CONTAINER, MUSLIN NAPKIN, ETC.) AND ITS HEAT-RESISTANCE, IT IS IMPORTANT THAT YOU CHOOSE THE APPROPRIATE PROGRAM BY REFERRING TO THE TABLE SHOWN ON THE NEXT PAGE.

WARNING



THE DEVICE MUST NOT BE USED FOR STERILIZING FLUIDS, LIQUIDS OR PHARMACEUTICAL PRODUCTS.

PROGRAM SUMMARY TABLE

PROGRAM DESCRIPTION	NOMINAL VALUES			BASIC PROGRAM PARAMETERS							STERILIZABLE MATERIAL					NOTES	
	Temperature (°C)	Pressure (bar)	Holding time (min)	Pre-vacuum ⁽¹⁾ (F=fractionated; S=single)	Standard drying ⁽²⁾ (L=long; S=short)	Total cycle time ⁽³⁾ (approx. max.)			Average consumption H ₂ O (ml/cycle)	Average energy consumption (kWh/cycle)	TYPE	MAX TOTAL MASS (kg)		MAX MASS PER TRAY (kg)			MAX MASS PER ARTICLE (kg)
						220V						17/17V	21V	17/17V	21V		
						17	17V	21V									
134 POROUS / WRAPPED	134	2.10	4	F	L	43'	38'	43'	525	0.8	Unpackaged porous material	1.00	1.25	0.30	0.40	0.30	
											Porous material in single package	0.75	1.00	0.25	0.30	0.25	
											Porous material in double package	0.60	0.75	0.20	0.25	0.20	
											Solid material / handpieces in single package	3.00	4.00	1.00	1.25	0.25	
											Solid material / handpieces in double package	1.50	2.00	0.50	0.60	0.25	
121 POROUS / WRAPPED	121	1.10	20	F	L	58'	53'	58'	550	0.8	Unpackaged porous material	1.00	1.25	0.30	0.40	0.30	
											Porous material in single package	0.75	1.00	0.25	0.30	0.25	
											Porous material in double package	0.60	0.75	0.20	0.25	0.20	
											Solid material / handpieces in single package	3.00	4.00	1.00	1.25	0.25	
											Solid material / handpieces in double package	1.50	2.00	0.50	0.60	0.25	
134 HOLLOW / UNWRAPPED	134	2.10	4	F	S	38'	31'	36'	525	0.7	Unpackaged handpieces	6.00	7.50	1.20	1.50	0.50	
121 HOLLOW / UNWRAPPED	121	1.10	20	F	S	53'	46'	51'	550	0.7	Unpackaged handpieces	6.00	7.50	1.20	1.50	0.50	
134 SOLID / WRAPPED	134	2.10	4	S	L	32'	26'	30'	300	0.6	Solid material in single package	3.00	4.00	1.00	1.25	0.25	
121 SOLID / WRAPPED	121	1.10	20	S	L	47'	41'	45'	325	0.6	Solid material in single package	3.00	4.00	1.00	1.25	0.25	
134 SOLID / UNWRAPPED	134	2.10	4	S	S	24'	21'	25'	300	0.5	Unpackaged solid material	6.00	7.50	1.20	1.50	0.50	
121 SOLID / UNWRAPPED	121	1.10	20	S	S	39'	36'	41'	325	0.5	Unpackaged solid material	6.00	7.50	1.20	1.50	0.50	
134 EMERGENCY	134	2.10	3	S	S	16'	12'	14'	300	0.45	Unpackaged solid material	0.50	0.50	0.50	0.50	0.50	
134/121 CUSTOM ⁽⁴⁾	134 or 121	2.10 or 1.10	> 4 or > 20	F/S	L/S	56' max	48' max	58' max	550 max	0.9 max	Unpackaged solid material	6.00 max	7.50 (max)	1.20 max	1.50 (max)	0.50 max	
HELIX / BOWIE & DICK TEST	134	2.10	3.5	F	S	22'	20'	22'	-	-	Test pack only (without any other load)	-	-	-	-	-	
VACUUM TEST	-	-0.80	-	-	-	22'	18'	18'	-	-	Empty chamber	-	-	-	-	-	

For material and instruments in (single and double) packaging, we recommend using the 3-tray configuration

GENERAL NOTES

- (1) **FRACTIONATED** = Pre-vacuum stage completed with a sequence of 3 vacuum pulses + 3 pressure pulses. “Fractionated vacuum” programs are dedicated to the sterilization of porous materials or handpieces.

SINGLE = Pre-vacuum stage completed by 1 vacuum + 1 pressure pulse.
“Single vacuum” programs are dedicated to the sterilization of solid materials.

- (2) **LONG** = Drying stage for porous material and/or handpieces and/or solid material in single/double package. The validated **LONG** drying time (**STANDARD** option) is **16.5 min**.

The **EXTRA** and **INTELLIGENT** options have **not** been validated.

SHORT = Drying stage for unpackaged solid instruments and/or unpackaged handpieces. The validated **SHORT** drying time (**STANDARD** option) is **7 min**.

The **FAST** option, with a drying time of **2.5 min** (up to a load of **1.0 kg max**) has **not** been validated.

- (3) The **Total Cycle Time** indicates the approximate time required for the completion of the entire program. It does not include warm up phase initiated when the start button is pressed. Times are dependant on input voltage and load condition.

- (4) The program **121°C / 134°C CUSTOM** has holding times of 20 minutes (or more) and 4 minutes (or more) respectively at 121°C and 134°C.

Pre-vacuum type and **Drying type** can be set according to the indications given in the notes **(1)** and **(2)** above.

The **121°C / 134°C CUSTOM** programs have **not** been validated.

STERILIZATION PROGRAM DIAGRAM

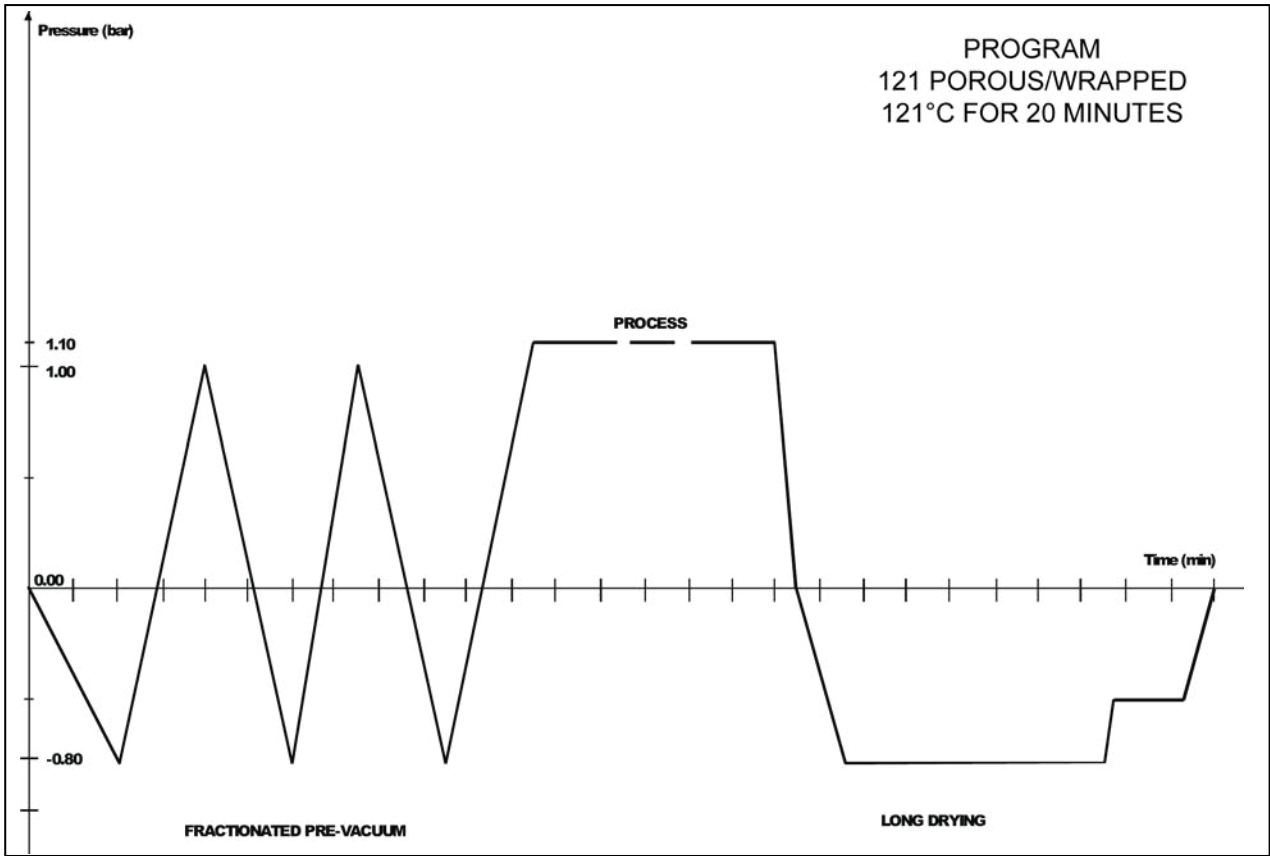
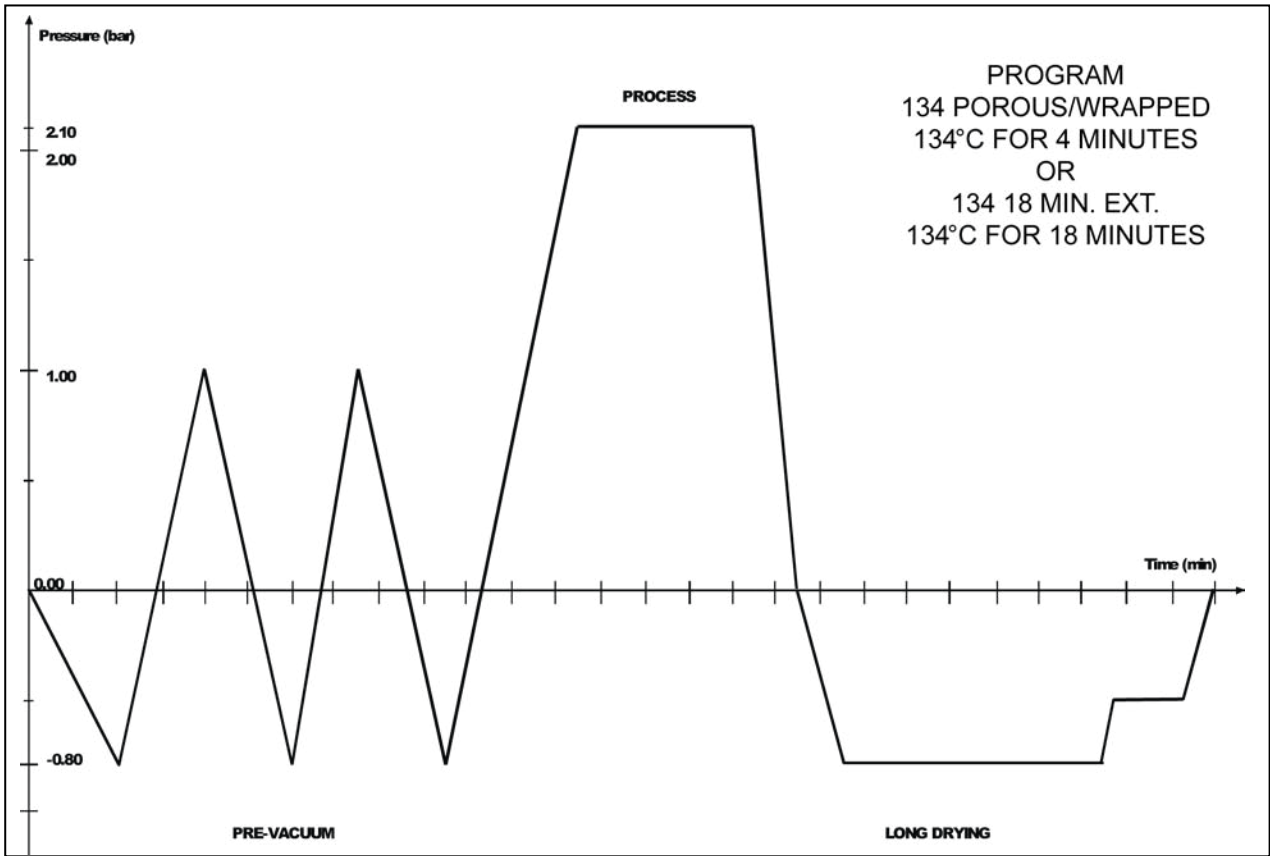

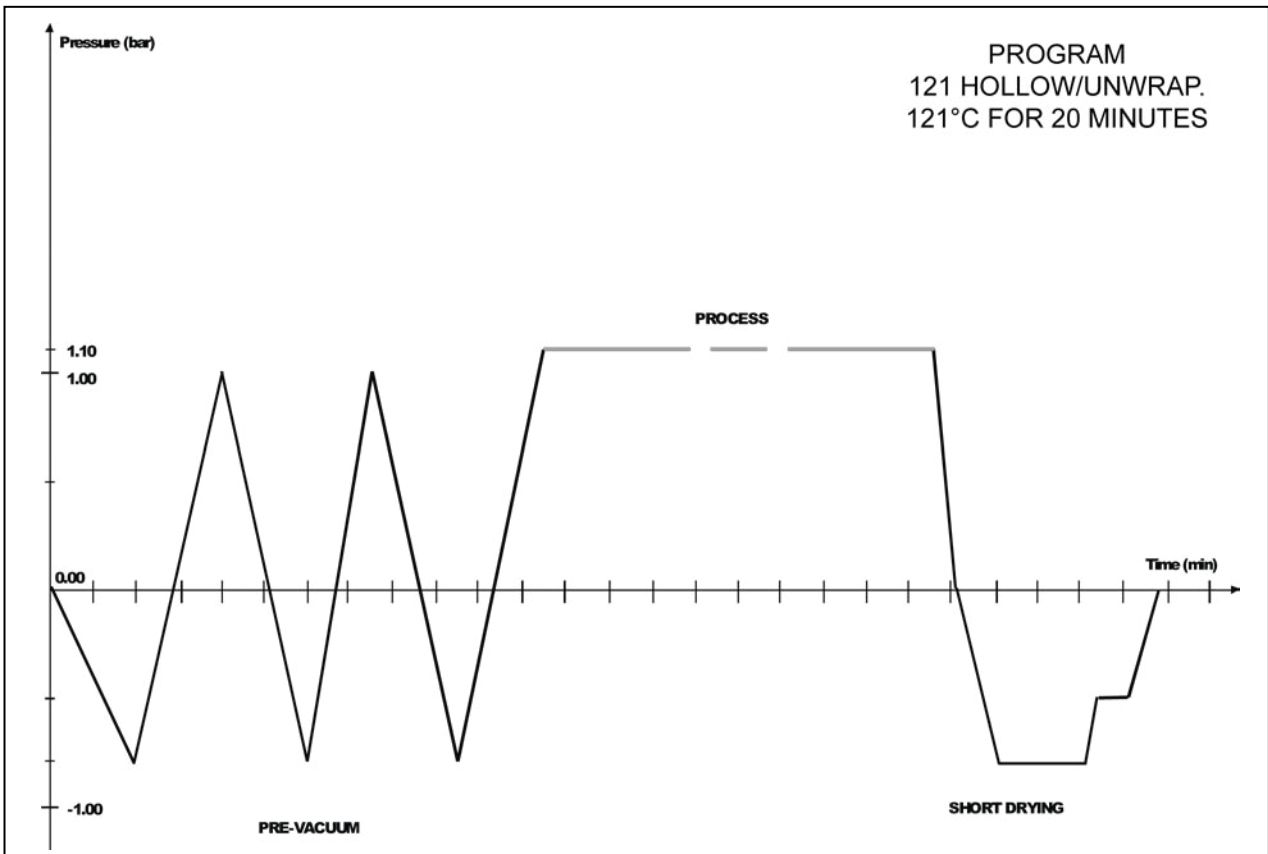
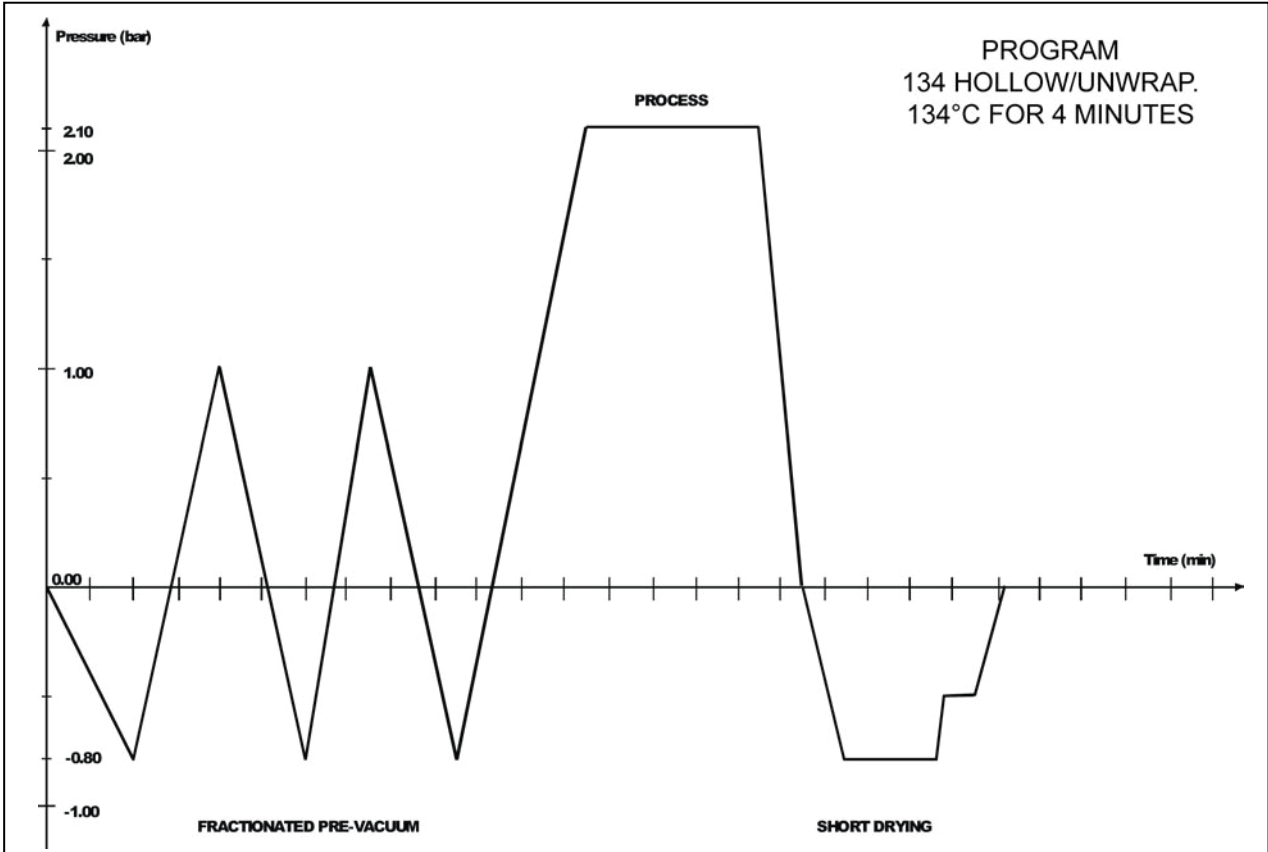

APPENDIX B – PROGRAMS

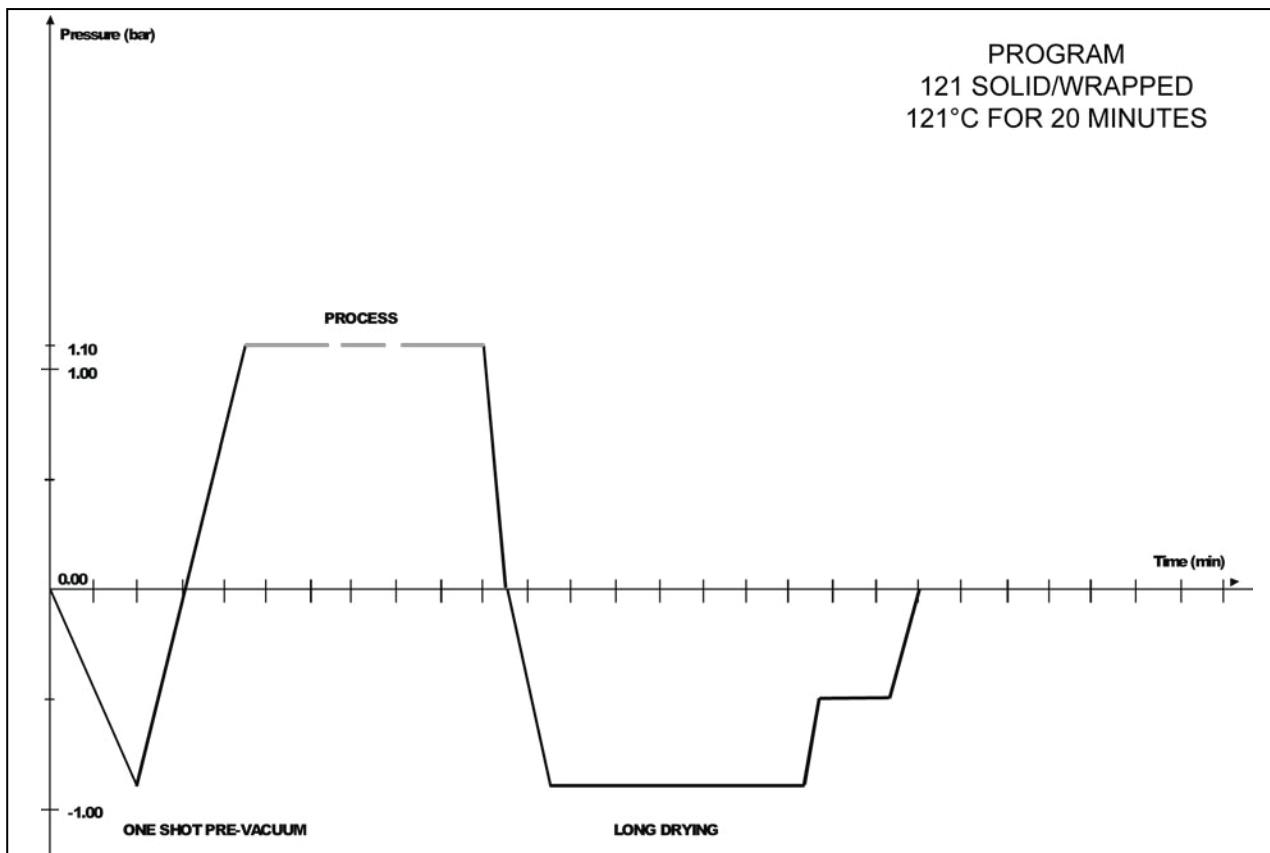
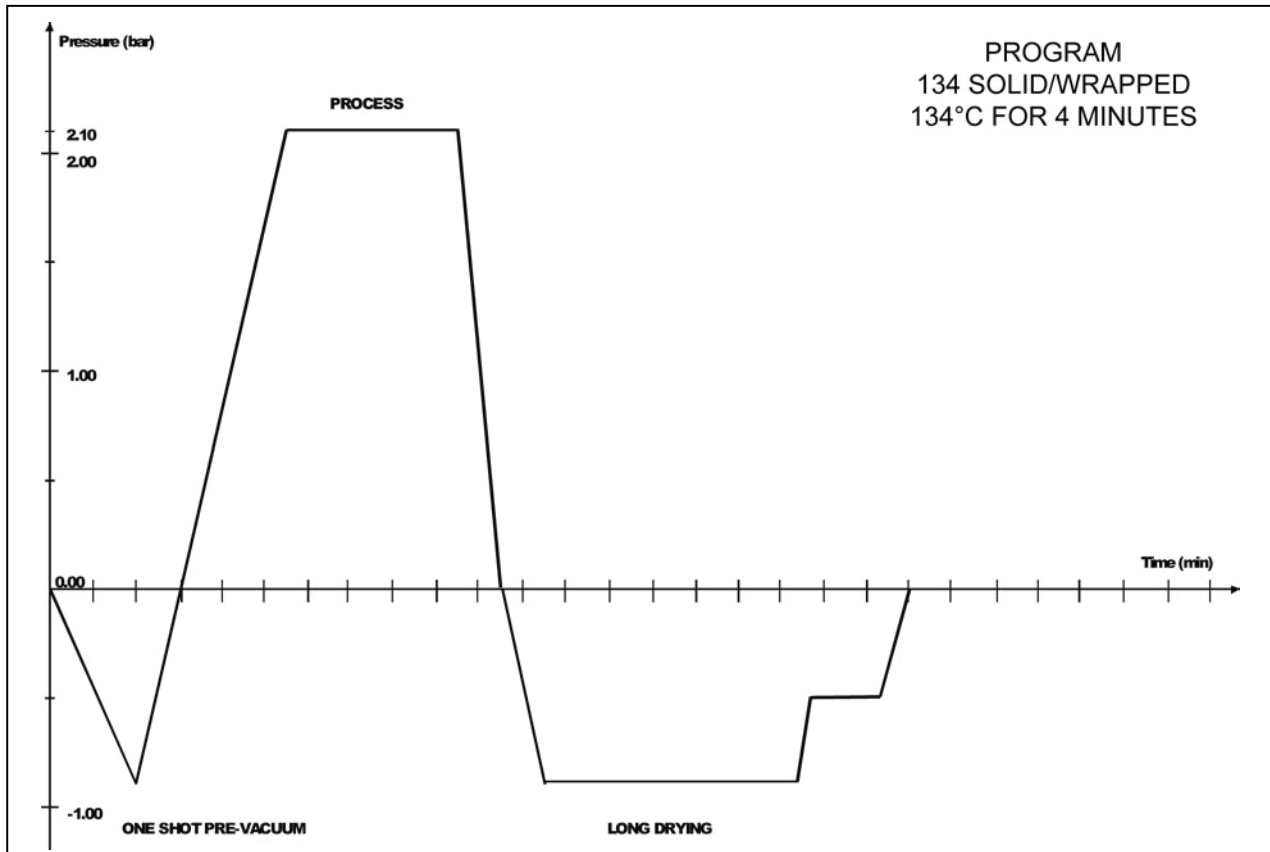

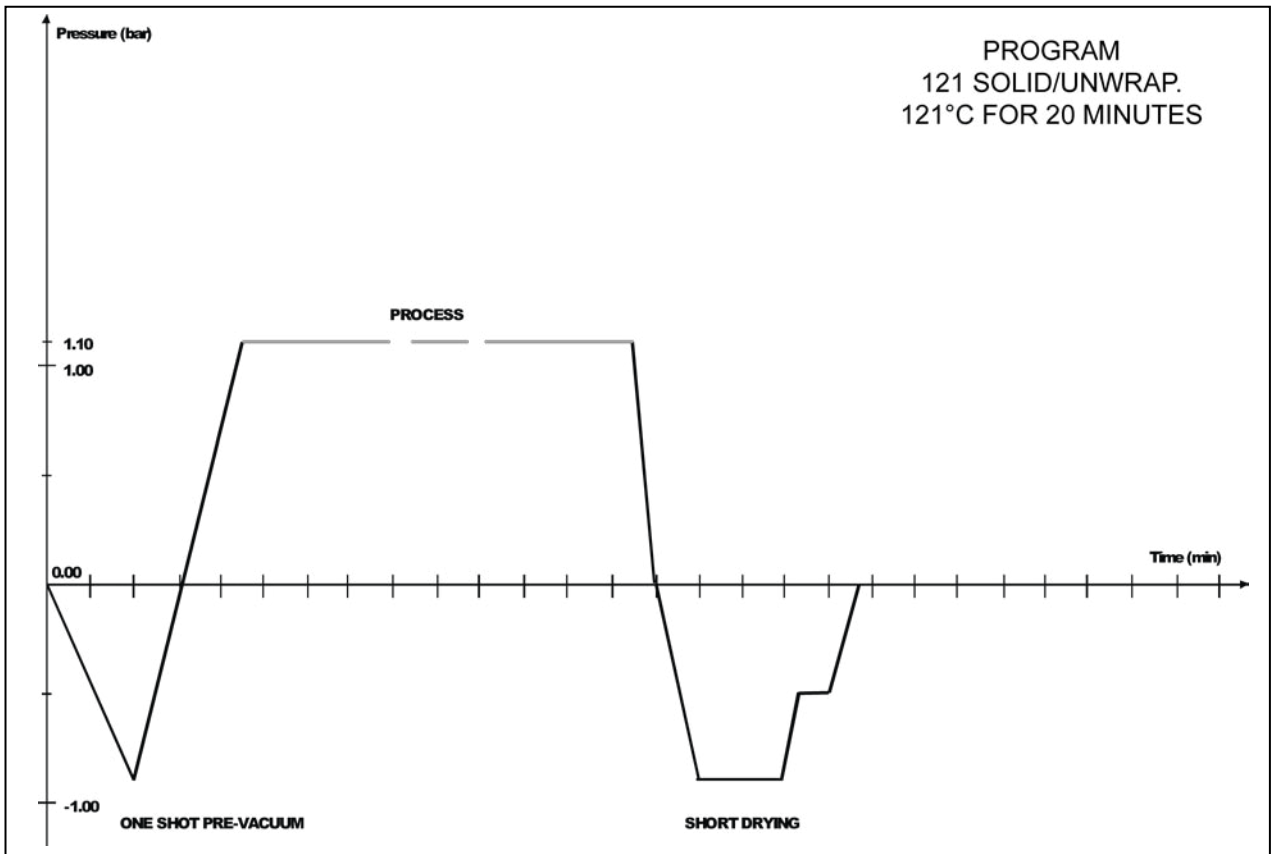
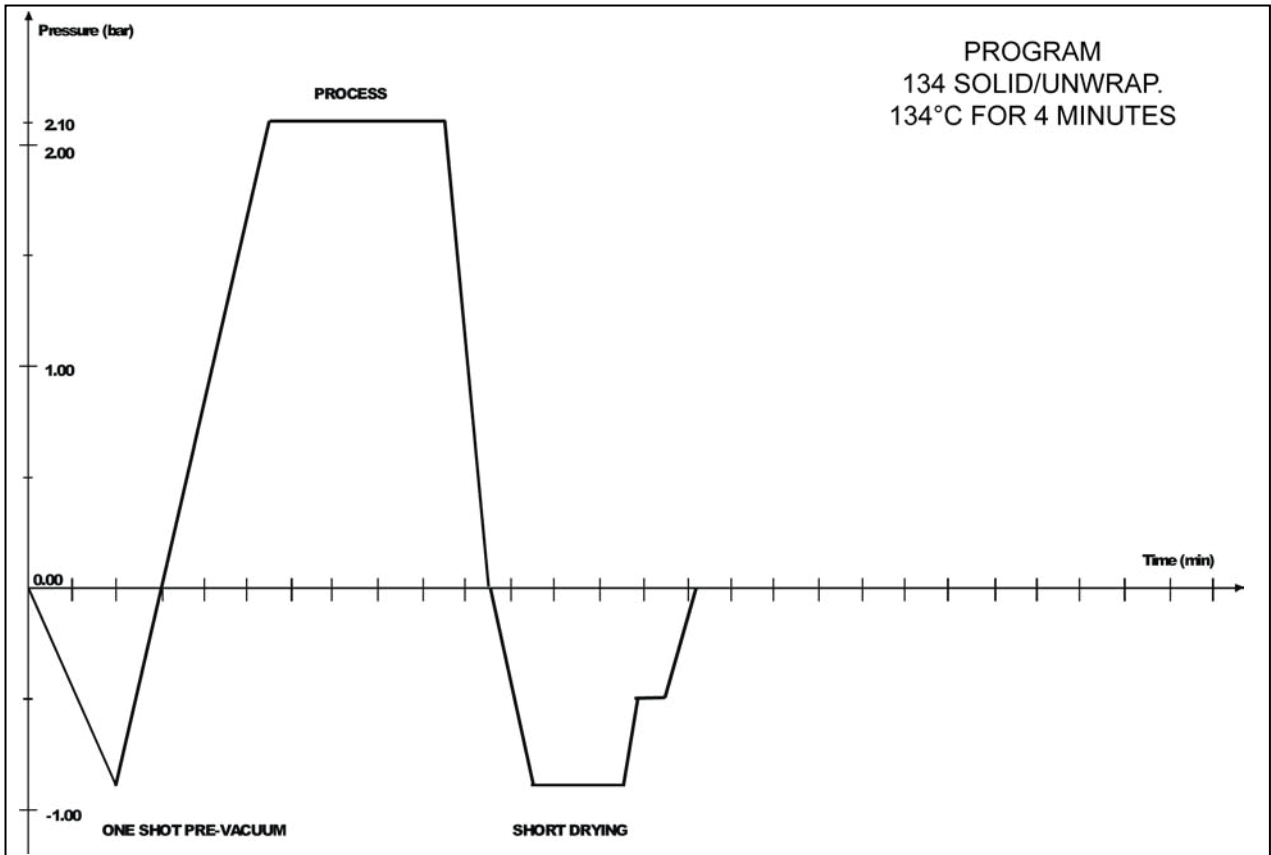

APPENDIX B – PROGRAMS

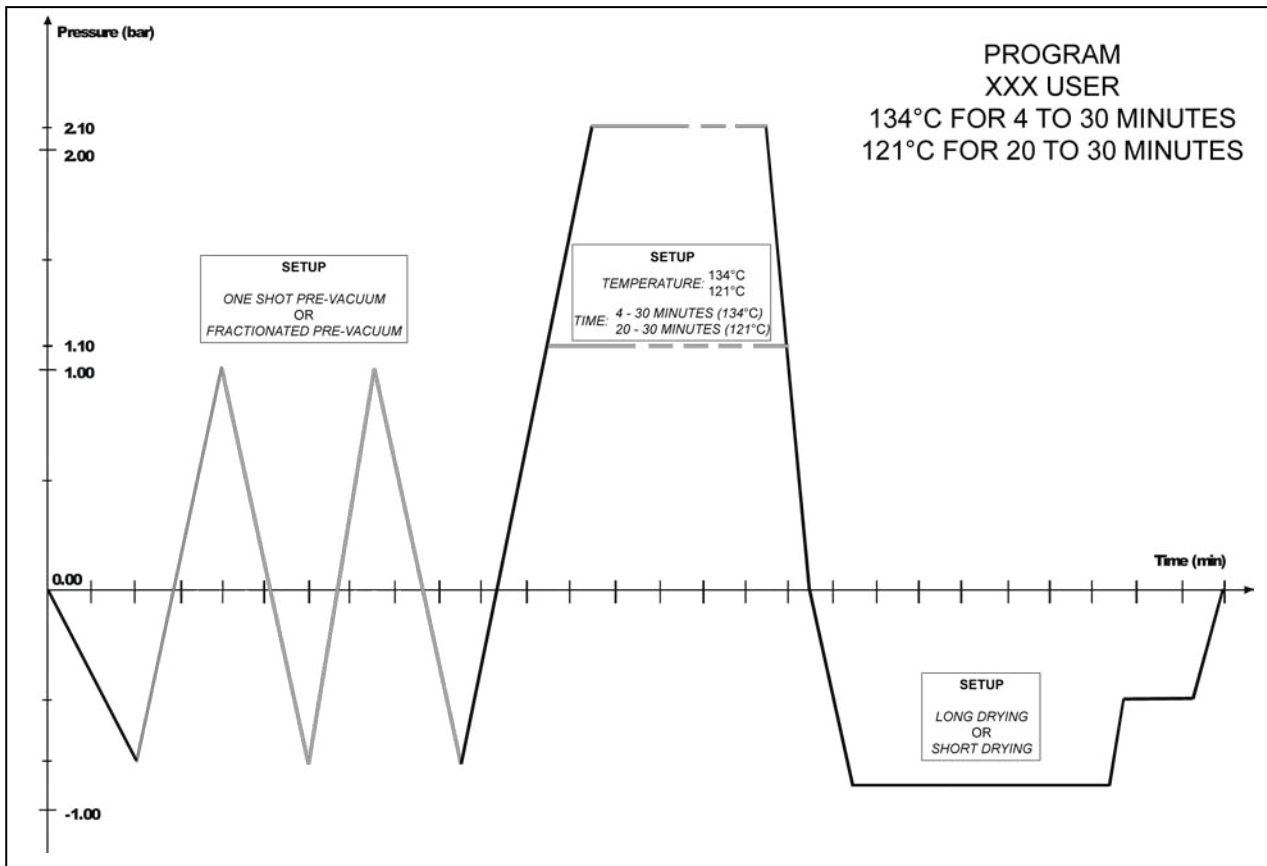
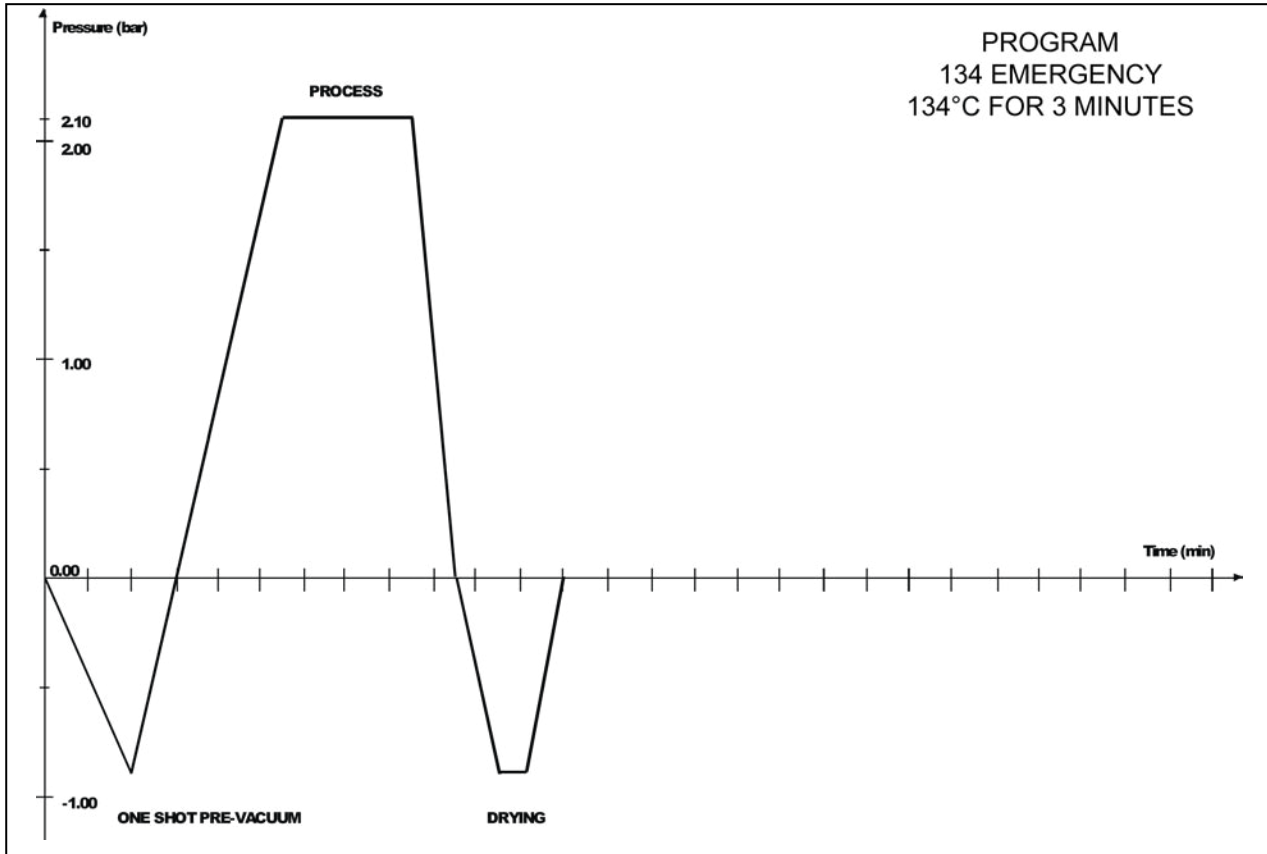

DIAGRAMS OF THE TEST CYCLES

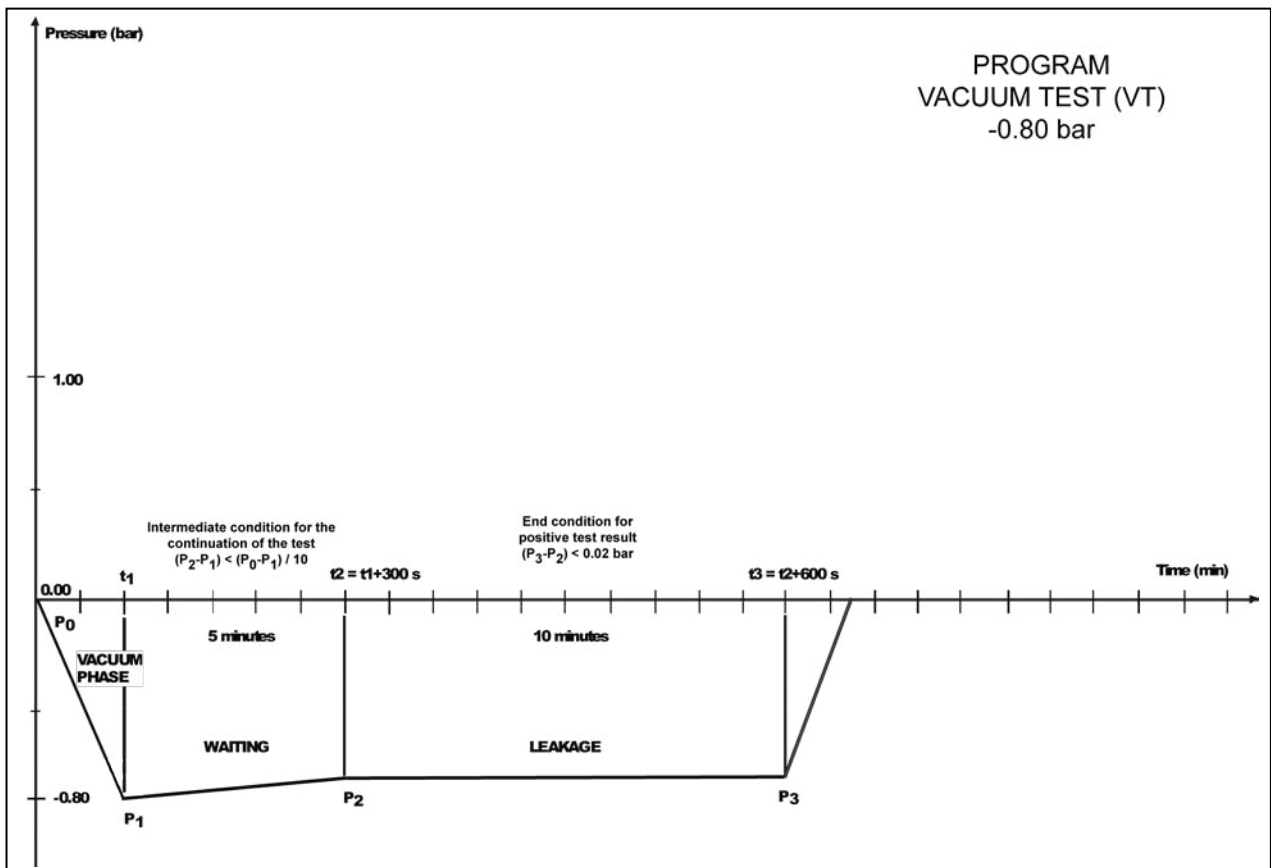
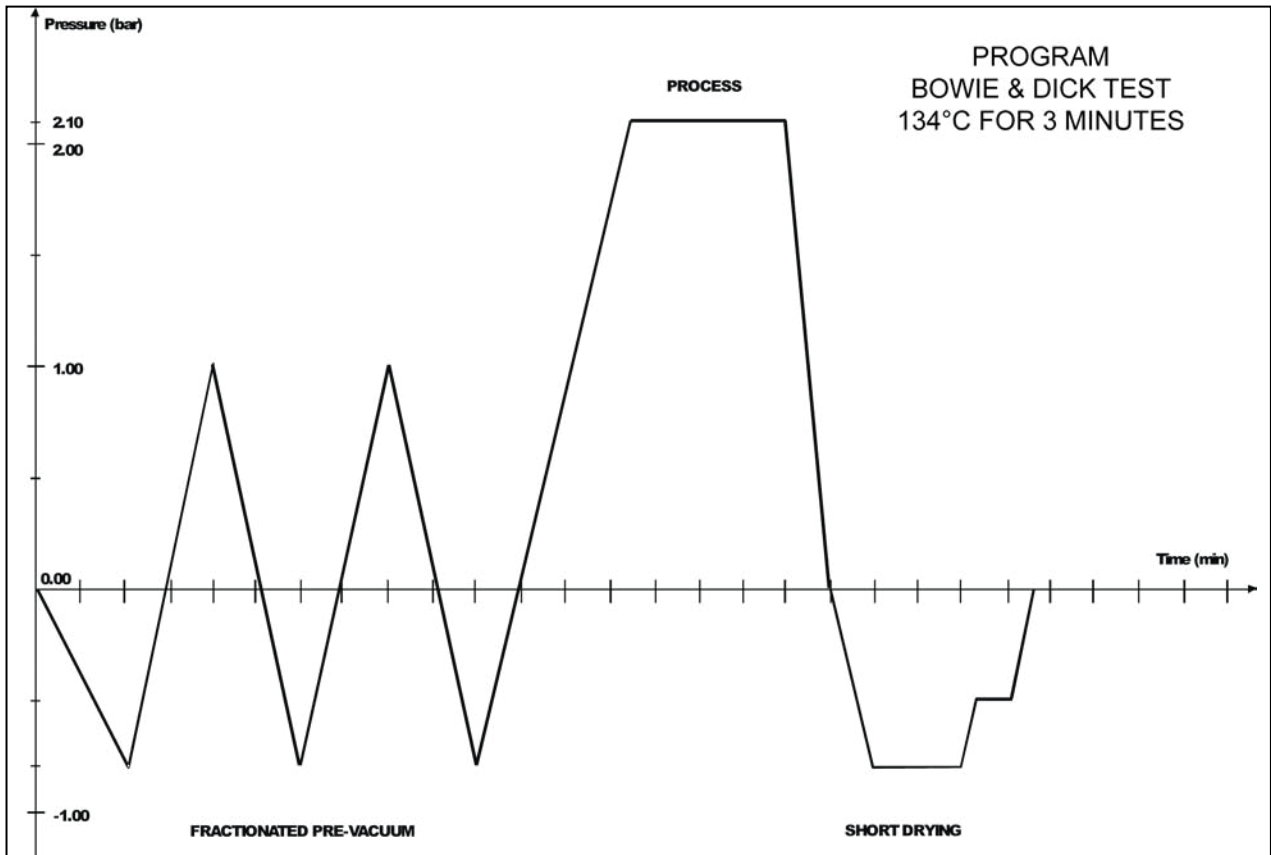

EXAMPLES OF PRINTED REPORTS

Cycle Report (normal)

Model Bravo17
 S/N 03 BM 0001
 Ver. SW Exxxx/BMyyyyyy
 Counter 0007/0015
 Selection 134c SOLID/UNWRAPPED
 Temperature 134 °C
 Pressure 2.10 bar
 Process time 4 min
 Stand-by LOW
 Pre-vacuum SINGLE
 Drying FAST

CYCLE START 19/11/02
 12:14

Time	C	bar
00:01	CS	079.4 +0.00
02:02	1PV	093.7 -0.80
05:48	ET	135.6 +2.15
06:02	SS	135.9 +2.17
07:02		135.6 +2.14
08:02		135.5 +2.14
09:02		135.4 +2.14
10:02	SE	135.5 +2.15
10:37	DS	104.1 +0.00
11:41	SPD	047.5 -0.90
16:08	DE	047.6 -0.84
17:12	CE	084.6 -0.04

06:32 MAX 136.0
 09:59 MIN 135.4

Drying Pulses 01
 CYCLE END 19/11/02
 12:27

STERILIZATION: POSITIVE

OPERATOR

Model Bravo17
 S/N 03 BM 0001
 Ver. SW Exxxx/BMyyyyyy
 Counter 0007/0015
 Selection 134c POROUS/WRAPPED
 Temperature 134 °C
 Pressure 2.10 bar
 Process time 4 min
 Stand-by HIGH
 Pre-vacuum FRACTIONATED
 Drying STANDARD

CYCLE START 19/11/02
 09:52

Time	C	bar
00:01	CS	075.1 -0.00
01:57	1PV	047.5 -0.80
04:53	1PP	120.5 +1.00
07:00	2PV	061.1 -0.80
09:15	2PP	120.4 +0.98
11:22	3PV	061.1 -0.80
15:04	ET	135.5 +2.15
15:19	SS	135.9 +2.17
16:19		135.4 +2.14
17:18		135.5 +2.15
18:19		135.4 +2.14
19:19	SE	135.5 +2.15
19:53	DS	104.4 +0.00
20:57	SPD	048.4 -0.90
26:55	EPD	094.9 -0.86
29:15	DE	112.6 -0.47
29:43	CE	115.8 -0.04

16:20 MAX 135.9
 18:11 MIN 135.4

Drying Pulses 05
 CYCLE END 19/11/02
 10:17

STERILIZATION: POSITIVE

OPERATOR

**Cycle Report (extended)
 at the operator's request**

Model Bravo17
 S/N 03 BM 0001
 Ver. SW Exxxx/BMyyyyyy
 Counter 0007/0015
 Selection 134c POROUS/WRAPPED
 Temperature 134 °C
 Pressure 2.10 Bar
 Process time 4 min
 Stand-by HIGH
 Pre-vacuum FRACTIONATED
 Drying STANDARD

CYCLE START 19/11/02
 09:52

Time	T1	P	T2	T3	T4
00:01	CS	075.1 -0.00	130.9	115.2	093.4
00:11		074.9 -0.28	133.3	114.2	094.0
00:21		074.4 -0.46	146.3	113.2	094.5
00:31		074.3 -0.57	152.6	112.2	095.0
00:35 ..		074.3 -0.59	154.2	111.9	095.2
00:51 ..		078.9 -0.62	152.2	110.4	095.6
01:01 ..		074.9 -0.73	146.6	109.6	095.7
01:27 ..		047.8 -0.78	149.3	107.7	095.7
01:57 ..		047.8 -0.80	155.3	105.8	095.4

02:07 .. 076.5 -0.57 149.9 105.2 095.1
 02:17 .. 081.1 -0.49 142.1 104.6 094.6

08:15 ... 068.4 -0.76 151.8 104.7 102.3
 08:22 ... 061.1 -0.80 153.6 104.5 101.7

08:32 ... 097.4 +0.01 154.7 104.0 100.8
 08:42 ... 104.6 +0.24 148.9 103.7 101.0

15:04 ... 135.5 +2.15 143.3 111.7 131.7

15:19 ... 135.9 +2.17 148.5 113.5 132.6
 15:28 ... 135.3 +2.16 153.6 115.9 133.0

19:19 ... 135.5 +2.15 157.4 126.5 132.5

19:34 ... 134.4 +1.07 157.0 126.8 131.2
 19:49 ... 108.3 +0.25 156.4 126.8 119.9
 19:53 .. 104.4 +0.00 156.1 126.6 116.2

20:04 ... 094.2 -0.50 155.1 125.9 112.4
 20:19 ... 069.2 -0.73 153.7 124.5 112.9
 20:34 ... 059.2 -0.81 152.3 123.4 113.5
 20:49 ... 053.8 -0.87 151.2 122.9 113.6
 20:57 ... 048.4 -0.90 150.9 122.7 113.5

21:04 ... 047.1 -0.80 151.0 122.5 113.5
 23:31 ... 042.3 -0.89 153.3 122.0 112.2

26:55 ... 094.9 -0.90 153.3 121.7 112.3

27:10 ... 101.4 -0.67 154.0 121.7 112.3
 27:25 ... 105.4 -0.57 153.7 121.5 112.3

29:15 ... 112.6 -0.47 149.6 119.1 111.2

29:28 ... 115.2 -0.10 143.0 118.4 110.7
 29:43 CE 115.8 -0.04 147.4 110.1 110.7

16:20 MAX 135.9
 18:11 MIN 135.4

Drying pulses 05
 CYCLE END 19/11/02
 10:17

STERILIZATION: POSITIVE

OPERATOR

EXTENDED REPORT
 REQUESTED BY THE OPERATOR

**Report following a
 Manual Stop**

Model Bravo17
 S/N 03 BM 0001
 Ver. SW Exxxx/BMyyyyyy
 Counter 0007/0015
 Selection 134c POROUS/WRAPPED
 Temperature 134 °C
 Pressure 2.10 bar
 Process time 4 min
 Stand-by HIGH
 Pre-vacuum FRACTIONATED
 Drying STANDARD

CYCLE START 19/11/02
 11:13

Time	C	bar
00:01	CS	077.6 +0.01
01:40	1PV	088.7 -0.80
04:40	1PP	120.6 +1.00
05:40	2PV	062.9 -0.80
07:10	2PP	135.6 +1.00
08:20	3PV	135.5 -0.80
11:20	ET	135.4 +2.15
11:39	SS	135.5 +2.17
12:39		135.5 +2.14
13:39		104.1 +2.15
14:39		047.5 +2.15

STERILIZATION: NEGATIVE

OPERATOR

ALARM CODE: E999
 DESCRIPTION: MANUAL STOP

**Report following a
 Blackout**

Model Bravo17
 S/N 03 BM 0001
 Ver. SW Exxxx/BMyyyyyy
 Counter 0006/0012
 Selection 134c CUSTOM
 Temperature 134 °C
 Pressure 2.10 bar
 Process time 07 min
 Stand-by HIGH
 Pre-vacuum FRACTIONATED
 Drying FAST

CYCLE START 19/11/02
 15:31

BLACK OUT 19/11/02
 15:45

STERILIZATION: NEGATIVE

OPERATOR

ALARM CODE: E000
 DESCRIPTION: BLACK-OUT

Report following an alarm

Model Bravo17
 S/N 03 BM 0001
 Ver. SW Exxxx/BMyyyyyy
 Counter 0007-0015
 Selection 134c POROUS/WAPPED
 Temperature 134 °C
 Pressure 2.10 Bar
 Process time 4 min
 Stand-by HIGH
 Pre-vacuum FRACTIONATED
 Drying STANDARD

CYCLE START 19/11/02
 11:30

Time	T1	P	T2	T3	T4	
00:01	CS	075.1	-0.00	130.9	115.2	093.4
00:11		074.9	-0.28	133.3	114.2	094.0
00:21		074.4	-0.46	146.3	113.2	094.5
00:31		074.3	-0.57	152.6	112.2	095.0
00:35 ..		074.3	-0.59	154.2	111.9	095.2
00:51 ..		078.9	-0.62	152.2	110.4	095.6
01:01 ..		074.9	-0.73	146.6	109.6	095.7
01:27 ..		047.8	-0.78	149.3	107.7	095.7
01:57 ..		047.8	-0.80	155.3	105.8	095.4
02:07 ..		076.5	-0.57	149.9	105.2	095.1
02:17 ..		081.1	-0.49	142.1	104.6	094.6
08:15 ...		068.4	-0.76	151.8	104.7	102.3
08:22 ...		061.1	-0.80	153.6	104.5	101.7
08:32 ...		097.4	+0.01	154.7	104.0	100.8
08:42 ...		104.6	+0.24	148.9	103.7	101.0
15:04 ...		135.5	+2.15	143.3	111.7	131.7
15:19 ...		135.9	+2.17	148.5	113.5	132.6
15:28 ...		135.3	+2.16	153.6	115.9	133.0
19:19 ...		135.5	+2.15	157.4	126.5	132.5
19:34 ...		134.4	+1.07	157.0	126.8	131.2
19:49 ...		108.3	+0.25	156.4	126.8	119.9
19:53 DS		104.4	+0.00	156.1	126.6	116.2

STERILISATION NEGATIVE

ALARM CODE: A112
 DESCRIPTION: PTC SHORTCIRCUIT

CAUTION!
 PLEASE REFER TO USER MANUAL

**Cycle Report
 BOWIE & DICK TEST**

Model Bravo17
 S/N 03 BM 0001
 Ver. SW Exxxx/BMyyyyyy
 Counter 0011/0019
 Selection BOWIE&DICK TEST
 Temperature 134 °C
 Pressure 2.10 bar
 Process time 3.5 min

CYCLE START 19/11/02
 16:38

Time	C	bar
00:01	CS	076.4 +0.00
02:06	1PV	089.3 -0.89
04:35	1PP	120.4 +0.99
05:45	2PV	062.5 -0.78
07:02	2PP	120.2 +0.97
08:15	3PV	061.1 -0.79
11:00	..	135.6 +2.15
11:14	..	136.0 +2.17
12:14	..	135.6 +2.14
13:14	..	135.6 +2.15
14:14	..	135.5 +2.14
14:45	..	135.4 +2.14
15:20	..	111.5 +0.00
16:34	...	047.8 -0.89
18:21	...	059.5 -0.86
19:21	..	075.4 -0.50
20:06	CE	078.7 -0.04
12:33	MAX	136.0
14:44	MIN	135.4

Drying pulses 01
 CYCLE END 19/11/02
 16:38

BOWIE&DICK TEST COMPLETE
 Please attach the indicator hereunder

OPERATOR

**Cycle Report
 VACUUM TEST**

Model Bravo17
 S/N 03 BM 0001
 Ver. SW Exxxx/BMyyyyyy
 Counter 0011/0019
 Selection VACUUM TEST

CYCLE START 19/11/02
 11:37

Time	C	bar
00:00	CS	035.0 +0.00
01:39	E1F	037.4 -0.80
6:39	E2F	038.4 -0.79
16:39	E3F	042.0 -0.79
17:54	CE	045.5 -0.01

CYCLE END 19/11/02
 11:41

VACUUM TEST: POSITIVE

OPERATOR

APPENDIX C - MAINTENANCE

Regular maintenance will guarantee safe, efficient operation of the Bravo over the device's entire life.

For better quality maintenance, supplement ordinary checks with regular periodic examinations by a qualified technical service department (see *Appendix Z*).

It is highly recommended users perform a periodic sterilizer validation or 'check' of the thermodynamic parameters of the unit's processes by comparing them with the reference values provided with suitably calibrated instruments. In this regard, see "Periodic Sterilizer's Validation", below.

The ordinary maintenance described here is easy to complete and involves simple instruments.

WARNING



ALWAYS USE ORIGINAL REPLACEMENT PARTS.

ROUTINE MAINTENANCE

Follow this schedule to keep the sterilizer operating at peak efficiency. If units undergo **very intense use**, we recommend **shortening** maintenance intervals. The Bravo unit may remind you of this schedule on the LCD display.

Refer to the Maintenance Description below for further details.

DAILY	Clean the door gasket Clean external surfaces
WEEKLY	Clean the sterilization chamber and relative accessories Disinfect external surfaces
MONTHLY or 100 cycles	Clean the internal (and external - if installed) distilled water tank Safety valve maintenance Clean (or replace) the chamber drain filter
EVERY 3-6 MONTHS or 400 cycles	Replace bacteriological filter
ANNUAL or every 1000 cycles	Replace the door gasket
EVERY 3 YEARS or 3000 CYCLES (by approved personnel only)	Recommended complete maintenance and calibration of the sterilizer

General warnings:

- **Do not** wash the sterilizer with direct jets of water, either under pressure or sprinkled. Seepage into electrical and electronic components could damage the functioning of the device or its internal parts;
- **Do not** use abrasive cloths, metal brushes or metal-cleaning products, whether solids or liquids, to clean the device or sterilization chamber;
- **Do not** use chemical products or disinfectants to clean the sterilization chamber. In fact, these products can irreparably damage the sterilization chamber;
- **Do not** allow lime residue or other substances to accumulate in the sterilization chamber or on the door and its gasket. They can damage these parts over time in addition to compromising the operation of the components installed along the plumbing circuit.

NOTE



THE FORMATION OF WHITE SPOTS ON THE BASE OF THE INTERNAL WALLS OF THE STERILIZATION CHAMBER IS AN INDICATION THAT YOU ARE USING LOW-QUALITY DEMINERALIZED WATER.

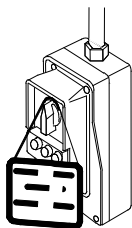

DANGER

 **BEFORE PERFORMING ORDINARY MAINTENANCE, MAKE SURE THAT THE POWER SUPPLY CORD IS REMOVED FROM THE MAINS SOCKET.**

WHEN IT IS NOT POSSIBLE, TURN OFF THE EXTERNAL BREAKER OF THE EQUIPMENT POWER SUPPLY LINE.

IF THE EXTERNAL BREAKER IS FAR AWAY OR, AT ANY RATE, NOT VISIBLE TO THE MAINTAINANCE WORKER, PLACE A WORK IN PROGRESS SIGN ON THE EXTERNAL BREAKER AFTER TURNING IT OFF.

MAINTENANCE DESCRIPTION

Clean door gasket and porthole (door plate)

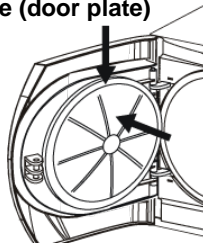

To remove traces of lime, clean the door gasket of the container and the porthole (door plate) with a clean, cotton cloth soaked in a weak solution of water and vinegar (or similar product). Dry the surfaces and remove any residue before using the device.

Clean external surfaces

Clean all the external parts using a clean cotton cloth dampened with water and, if needed, a neutral detergent. Dry the surfaces and remove any residue before using the device.

Clean sterilization chamber and accessories

Clean the sterilization chamber, support and trays (and internal surfaces in general) with a clean cotton cloth soaked in water and, if needed, use a small amount of neutral detergent. Carefully rinse with distilled water, taking care not to leave any type of residue in the chamber or on accessories.

NOTE

 **DO NOT USE SHARP OR POINTED INSTRUMENTS TO REMOVE LIME ENCRUSTATION FROM THE STERILIZATION CHAMBER. WHEN THERE ARE VISIBLE DEPOSITS, IMMEDIATELY CHECK THE QUALITY OF THE DISTILLED WATER USED (SEE APPENDIX A).**

Disinfect external surfaces

For the occasional disinfection of the external surfaces, you can use either denatured alcohol or detergents with a small percentage of sodium hypochlorite (or equivalent).

APPENDIX C – MAINTENANCE

Clean internal distilled water tank

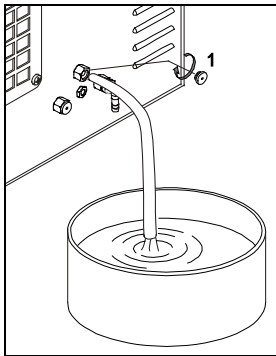

1. Arrange an empty container on the floor near the sterilizer and insert the free end of a tube.
2. Unscrew the plug (1) from the rear draining point and plug in the other end of the tube.
3. Wait until the internal tank is completely drained and close the draining point with the plug.
4. Prepare 4 litres / 1.06 US gal of distilled water mixed with 10% of pure alcohol, such as isopropyl, and fill the supplied standard container
5. Fill the internal tank completely with this solution (see Chapter 5 – Instructions for Use **Filling distilled water** for the procedure) and allow the solution to sit for 30 minutes.

WARNING

DO NOT RUN ANY CYCLE DURING THIS PERIOD.

6. Now drain the internal tank and discard the solution. Close the draining point with the plug.
7. Run one empty (no load) cycle of your choice

Clean external distilled water tank

1. Disconnect the external tank from the sterilizer and close the tank valve.
2. Fill the tank with a solution of distilled water and alcohol (10%), such as isopropyl.
3. Allow the solution to sit for 30 minutes.
4. Drain the tank and discard the solution.
5. Fill the tank with water and drain it, to remove any residual alcohol solution.
6. Reconnect the tank to the sterilizer and refill with distill water.

Safety valve maintenance

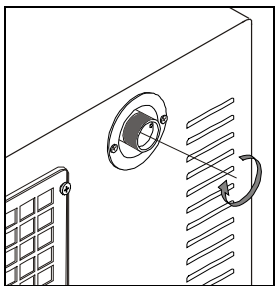

1. Access the safety valve located on the rear of the machine.
2. Loosen the knurled locking ring with your fingers (or a suitable tool inserted in the two holes of the ring itself), turning counter-clockwise until it reaches the end and turns loosely.
3. Retighten the locking ring making sure the threads are properly engaged.
4. **Definitively** tighten the locking ring all the way down.

WARNING

THE USER SHOULD PERFORM THIS OPERATION MONTHLY TO GUARANTEE THE CORRECT FUNCTIONING OF THE VALVE OVER TIME. AT THE END OF THE MAINTENANCE, MAKE SURE THAT THE LOCKING RING IS COMPLETELY SCREWED ON AND TIGHTENED.

Clean/replace the drain filter

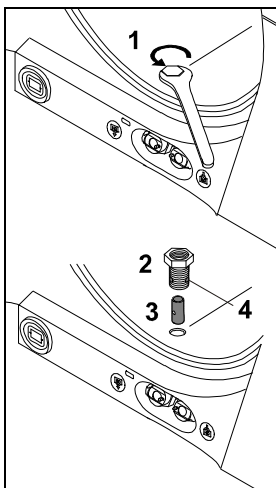

Over time various residues will accumulate inside the filter, obstructing the lower drain tube.

For cleaning (or replace) the filter, open the door of the sterilizer and remove the nut (1) with a hexagonal wrench no. 14.

Then remove the fitting (2) and the filter (3).

Remove the filter from the support and carefully clean it under running water, using if necessary a pointed tool to remove possible material of greater dimensions.

If the filter cannot be reused, replace it with a new one.

Reassemble all the parts reversing the order in which you removed the parts. Pay attention on screwing down the fitting (2) so as to let the draining holes (4) at level of the chamber wall.

Replace bacteriological filter

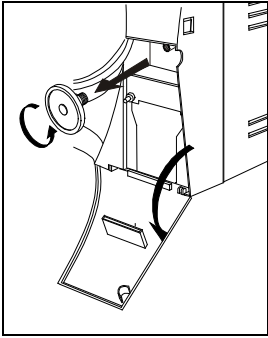

When it is due to be changed, or when you notice visible clogging of the filter (when the filter turns gray) unscrew the bacteriological filter from its support and replace it with a new one by screwing it all the way down on the connector on the front of the machine.

NOTE



A REPLACEMENT BACTERIOLOGICAL FILTER IS SUPPLIED WITH THE DEVICE. TO REQUEST OTHERS, PLEASE REFER TO **APPENDIX Z, TECHNICAL SUPPORT.**

Replace the door gasket

Check the inside of the door to ensure it is not hot and then remove the old gasket by hand. Clean the door gasket seat to ensure it is debris free.

Install the new door gasket by pressing the gasket into its seat, first on top, then bottom, then both sides. Once seated on 4 sides, continue to press the remaining gasket completely into its seat

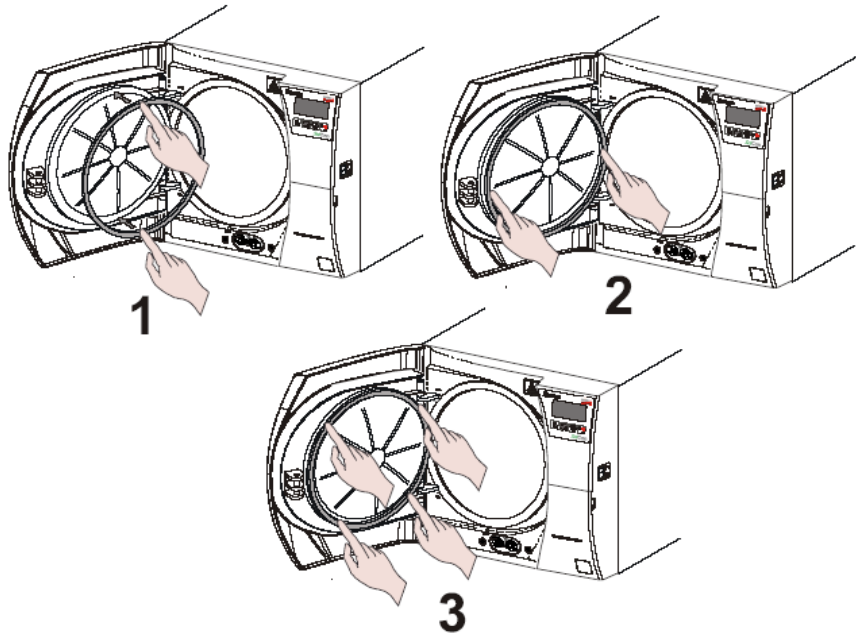

Replacing the printer paper on units equipped with internal printers

Printer type 1

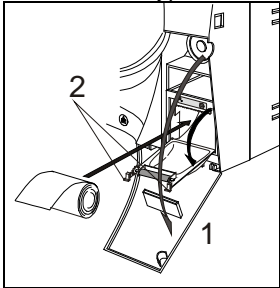

To replace the printer paper:

Printer type1:

1. Open the door (1) of the service compartment to access the printer.
2. Push the tongues (2) to open the printer door and access the paper compartment.
3. Remove the empty roll and place a new roll of **thermal paper** so that the paper unrolls from the top.
The roll must have the following dimensions:
- width 57 mm (2.24") / diameter max 45 mm (1.77")
4. Unroll about 15 cm (6") of paper and close the compartment door,
5. Thread the paper in the service compartment door slot and close.

Printer type 2

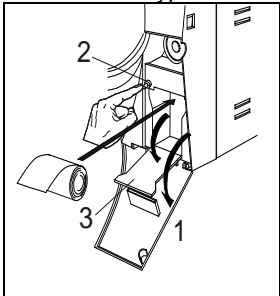

Printer type2:

1. Open the door (1) of the service compartment to access the printer,
2. Push the button (2) on the left to open the printer door (3) and access the paper compartment,
3. Remove the empty roll and place a new roll of **thermal paper** so that the paper unrolls from the top;
The roll must have the following dimensions:
- 57 mm (2.24") / diameter max 45 mm (1.77")
4. Unroll about 15 cm (6") of paper and close the compartment door (the paper will automatically advance outside the window for several centimeters),
5. Thread the paper in the service compartment door slot and close.

Periodic sterilizer calibration and 3000 cycle maintenance

To ensure proper performance of the unit, **calibrate** the **sensors** (pressure and temperature), verify the performance of all major components at least every three years or 3000 cycles

Ensuring the sterilizer is routinely maintained and properly verified over time is the **responsibility of the user**.

The 3000 cycle maintenance and calibration procedure requires the use of special equipment (high-precision reference instruments, calibration tools, dedicated software, etc.) suitably verified and calibrated in addition to specific experience and training. It is therefore recommended to contact Technical Service to perform this maintenance

NOTE



THE SciCAN CUSTOMER SUPPORT DEPARTMENT (SEE APPENDIX Z) CAN PROVIDE ANY INFORMATION RELATIVE TO THE PERIODIC CALIBRATION OF THE STERILIZER.

APPENDIX D – TROUBLESHOOTING

Analysis and resolution of problems

If your sterilizer is **not** working correctly, please consult this list before calling the Technical Service Department:

PROBLEM	POSSIBLE CAUSE	PROPOSED SOLUTION
The sterilizer does not power-on.	The power cord is not plugged-in.	Plug it in.
	There is no voltage at the socket.	Check the cause for the lack of voltage at the socket and fix it.
	The main switch and/or differential switch are OFF.	Turn the switch ON.
	The mains fuses are blown.	Replace with good fuses of equal nominal value. (See the <i>Summary Table</i> in Appendix A, Technical Characteristics).
After pressing START , the sterilization cycle does not start.	The device is preheating.	Wait for the sterilizer to reach the proper operating conditions for starting the program. NOTE: Under normal conditions, the average preheating time is approx. 10-15 minutes.
The MIN water level icon is lit.	The distilled water level inside the tank is below the minimum level.	Fill the distilled water tank until the MAX level indicator comes on (<i>or, at least, until the MIN level signal turns off</i>).
The alarm icon is lit.	An alarm was triggered and an error code and message appear on the <i>LCD</i> .	Check the alarm code and take the appropriate action. (See the <i>following paragraphs, Alarms, Alarm Codes and Troubleshooting</i>).
The safety valve was triggered.	Locking ring loosened. Presence of anomalous overpressure in the chamber.	Check that the knurled locking ring is correctly tightened on the upper part of the safety valve. <div style="border: 1px solid black; padding: 5px; text-align: center;">DANGER  LET THE DEVICE COOL, OR WEAR GLOVES TO AVOID BEING BURNED WHEN TOUCHING THE VALVE.</div>
At the end of the program (CYCLE COMPLETE), the door will not open.	There is residual pressure remaining in the sterilization chamber at the end of the cycle. NOTE: the display shows: NOW LEVELLING PLEASE WAIT...	Wait several minutes, until the pressure returns to 0.00 bar, and try to open the door again. Check if the bacteriological filter is clogged and, if necessary, replace it with a new one. The procedure for storing the ambient temperature (SET 0 bar function) was not executed correctly. Contact the Technical Support Department (see Appendix Z)
	At the end of the cycle, the safety door lock remains on.	Contact the Technical Support Department (see Appendix Z).
There is water leaking from underneath the sterilizer.	Drain connectors or tubing (optional external tank) not correctly connected to the device.	Check the tightness of the fittings; if necessary, reassemble, paying more attention to sealing. Check that the tubes to the drain tank are completely pushed onto the connectors; make sure that the plastic ties have been applied.

APPENDIX D – TROUBLESHOOTING

PROBLEM	POSSIBLE CAUSE	PROPOSED SOLUTION
	The water supply tube from the external tank (optional) is not well connected.	Check the tightness of the connector; if necessary, reassemble, paying greater attention to sealing (see the Chapter 4 - "Installation"). Check that the tube coming from the external tank is completely pushed onto the connector; make sure that the plastic tie has been applied.
	Steam leaks from the gasket.	At the end of the cycle, clean the gasket and porthole of the container under pressure. Check if the gasket is damaged. Run another cycle and check the situation. If the gasket still leaks, replace it with a new one.
There is water around the drain tank.	Drain tubes (optional drain tank) not correctly connected to the tank.	Check that the tubes connected to the drain tank are correctly and completely pushed onto the connectors.
The sterilizer has problems creating a vacuum in the chamber (drying problems, presence of water in the sterilization chamber at the end of the cycle, etc.).	Drain filter of the sterilization chamber obstructed.	<u>Clean</u> or <u>replace</u> the drain filter. (See Appendix C "Maintenance").
	Drain circuit obstructed or drain tubes choked (optional drain tank).	Check that the drain tubes (and the connectors they are pushed onto) are not obstructed and run freely from the device to the tank.
	The air intake on the frame and/or the cover is obstructed or the heat exchanger is not sufficiently ventilated.	Remove all possible obstructions from the air intake and heat exchanger. Check that the device is not in direct contact with walls or surfaces (see the Chapter 4 - Installation).
Excessive humidity on the material and/or instruments at the end of the program.	There is too much material inside the sterilization chamber.	Check the quantity of material sterilized and make sure that it does not exceed the maximum allowed quantity, depending on the type of load. (See the <i>Summary Table</i> in Appendix A, Technical Characteristics).
	Material not correctly positioned.	Position the material, and especially wrapped material, according to the instructions. (See the Chapter 7 - Preparing the Material).
	Wrong sterilization program selection	Select the appropriate sterilization program for the type of material to be treated. (See the <i>Summary Table</i> in Appendix B, Programs).
	Drain filter of the sterilization chamber obstructed.	Clean or replace the drain filter. Check for kinks in the exhaust tube, if being used. (See Appendix C Maintenance).
Traces of oxidation or spots on instruments	Quality of the instruments is not adequate.	Check the quality of the instruments with the problem, checking whether the material they are made of can tolerate steam sterilization.
	Quality of the distilled water not adequate.	Empty the tank and fill it with high-quality distilled water. (See the <i>Water Supply Characteristics</i> in Appendix A, Technical Characteristics).
	Organic or inorganic residues on the instruments.	Carefully clean the material before subjecting it to the sterilization cycle. (See the Chapter 7 - Preparing the Material).
	Contact between instruments made of different metals.	Separate instruments made of different metals. (See the Chapter 7 - Preparing the Material).

PROBLEM	POSSIBLE CAUSE	PROPOSED SOLUTION
	Lime residue on the wall of the sterilization chamber and/or accessories.	Clean the device and its parts, as required. (See Appendix C “Maintenance”).
Blackening of the instruments or damage to the material.	Wrong sterilization program selection.	Check the adequacy of the sterilization temperature of the selected program in relation to the material to be treated. (See the <i>Summary Table</i> in Appendix B, Programs).
The printer (optional on some models) is not printing the summary report.	Wrong printer configuration.	Configure the sterilizer for the type of printer used (Configuration program). (see the Chapter 6 - Configuration).
	Out of paper.	Insert a new roll of paper. (See Appendix C, Replacing the Paper).
	Paper jammed.	Clear the jam. Check the dimensions of the paper roll. (See Appendix C, Replacing the Paper).

NOTE

 SHOULD ANY OF THESE PROBLEMS PERSIST, CONTACT CUSTOMER SERVICE (SEE **APPENDIX Z**) PROVIDING THE MODEL OF THE STERILIZER AND THE SERIAL NUMBER. THIS INFORMATION IS FOUND ON THE SERIAL NUMBER PLATE ON THE REAR OF THE DEVICE AND ON THE WARRANTY CERTIFICATE.

APPENDIX E – ALARMS

ALARMS

Every time an anomalous condition occurs during the operation of the sterilizer, an alarm is generated and a specific code (consisting of a letter followed by a 3-digit number) is displayed.

Alarm codes are divided into three categories:

- **E = ERROR**
Operator error or a cause external to the device.
A problem that can generally be fixed by the user.
Code format: **Exxx** (xxx = identifying number from 000 - 999)
- **A = ALARM**
First-level fault, **not linked** to safety.
A problem that normally is fixed by a specialized technician on-site.
Code format: **Axxx** (xxx = identifying number from 000 - 999)
- **H = HAZARD**
Second-level fault, **linked** to safety.
A problem generally fixed by the Technical Support Center.
Code format: **Hxxx** (xxx = identifying number from 000 - 999)

ALARM INTERVENTION

NOTE

 **IN THE CASE OF AN ALARM, DO NOT POWER OFF THE UNIT BEFORE YOU HAVE EXECUTED A RESET (SEE THE PARAGRAPH, "RESETTING THE SYSTEM").**

An alarm causes the interruption of the cycle with the relative **alarm code** displayed on the display, accompanied by a **beep** and a flashing **alarm icon**.

NOTE

 **DURING THE ALARM PROCEDURE, THE DISPLAY ALWAYS SHOWS THE CURRENT TEMPERATURE AND PRESSURE IN THE STERILIZATION CHAMBER.**

This procedure is designed to keep the user from mistaking an anomalous cycle for a correctly completed cycle and, as a consequence, involuntarily using non-sterile material.

The alarm procedure is **differentiated** depending on whether it occurs **during** the execution of the program or **outside**, and is structured to guide the user to the **necessary RESET** of the sterilizer.

Alarm during a cycle

If the alarm intervenes **during a program**, the display will show the message:

(Alarm Message)

L E V E L L I N G

1 1 4 . 6 ° C X X X X

0 . 7 0 b a r 1 1 : 3 0





SETUP



← Alarm Message

← Alarm Code

When an alarm is generated in certain phases of the cycle, an automatic procedure is activated to clean the internal water circuit. The display will contain the notice:

(Alarm Message)

C I R C U I T C L E A N I N G

1 0 0 . 6 ° C X X X X

0 . 7 0 b a r 1 1 : 4 0





SETUP



← Alarm Code

At the end of what has been described and having reached safe conditions, the machine activates a special procedure, that asks the user to manually unlock the door:

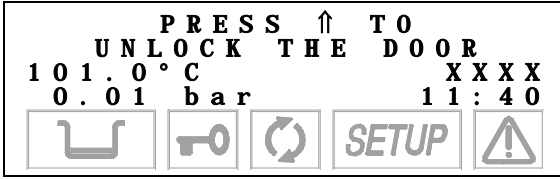

NOTE

 THE ABOVE INDICATED MESSAGE IS SHOWN **ONLY** WHEN THE PRESSURE IN THE CHAMBER IS WITHIN A SAFETY LIMIT. THE RELEASE OF THE LOCKING DEVICE IS **NOT** POSSIBLE WHEN THE PRESSURE VALUE IS OUTSIDE THIS LIMIT.

Press the ↑ key to unlock the door lock mechanism; the following message will appear:



Once the door is open, the user is asked to **reset** the system:

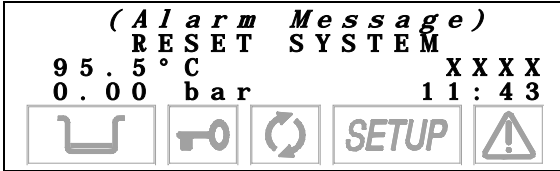

Perform a **RESET** (described below) and then turn-off the equipment and check the error or make the repair.

NOTE

 WHEN THE DOOR IS OPENED, THE REPORT (NORMAL OR EXTENDED DEPENDING ON THE TYPE OF ALARM) WILL BE PRINTED FOR THE INTERRUPTED STERILIZATION PROGRAM AND THE ALARM THAT INTERVENED. CHECK THE DOCUMENT, INITIAL IT IN THE SPACE PROVIDED AND FILE IT IN A SUITABLE PLACE. REFER TO THE PRINT REPORT EXAMPLES SHOWN IN APPENDIX B, PROGRAMS".

If the alarm intervenes **outside the sterilization or test program**, the display will show:

Alarm outside the cycle



Turn-off the equipment and check the alarm. Or, depending on the type of alarm:



which is automatically transformed to the message:

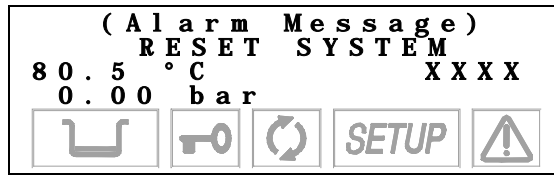

Perform a **RESET** (described below) and then turn-off the device and check the alarm.

NOTE

 **ALARMS THAT INTERVENE OUTSIDE OF A PROGRAM DO NOT PRODUCE A PRINTED REPORT.**

RESETTING THE SYSTEM



Depending on the alarm, the system must be reset in one of two ways. (see the **Alarm Code List** further below in this appendix):

1. Press and hold the *PROGRAM SELECTION* key for about 3 seconds. *A beep confirms the RESET.*

NOTE

 **NEVER TURN THE DEVICE OFF BEFORE TRYING TO EXECUTE A RESET AS DESCRIBED ABOVE.**



2. Turn-off the device and then power-on using the main switch. *Upon power-up, the sterilizer will perform its normal initial test.*



After RESET, and any technical intervention necessary to eliminate the fault, the device will go to STAND-BY mode, ready to execute a new program.

ALARM CODES

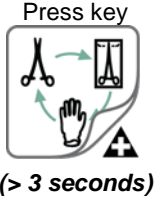
The list of alarm codes the messages displayed on the LCD and relative RESET mode are as follows:

CODE	ALARM DESCRIPTION	LCD INDICATION	RESET MODE
ERRORS (category E)			
E 000	Blackout	BLACK-OUT	
E 010	Door open	DOOR OPEN	
E 020	Exceeded timeout for activating door lock system (closing)	DOOR UNLOCKED	
E 021	Exceeded timeout for activating door lock system (opening)	DOOR LOCKED	
E 030	Water in the fill tank at minimum (MIN) level	WATER MIN	
E 031	Water in the drain tank at maximum (MAX) level	EXHAUST MAX	
E 041	Filling the tank too frequently (<i>automatic filling</i>)	FILLING PROBLEM	
E 900	Vacuum Test failed (<i>during the LEAKAGE PHASE</i>)	TEST FAILED	
E 901	Vacuum Test failed (<i>during the WAITING PHASE</i>)	TEST FAILED	
E 902	Vacuum Test failed (<i>vacuum pulse timeout exceeded</i>)	TEST FAILED	
E 999	Manual cycle interruption	MANUAL STOP	
ALARMS (category A)			
A 022	System door lock microswitches failed (OFF-OFF)	LOCKING PROBLEM	Turning-off device
A 023	System door lock microswitches failed (ON-ON)	LOCKING PROBLEM	
A 024	System door lock microswitches failed (ON-OFF)	LOCKING PROBLEM	
A 032	Sensor-level problem	LEVEL PROBLEM	
A 040	Failure to fill the tank (<i>automatic filling</i>)	FILLING PROBLEM	
A 101	PT1 broken (<i>sterilization chamber</i>)	PTC BROKEN	
A 102	PT2 broken (<i>steam generator</i>)	PTC BROKEN	
A 103	PT3 broken (<i>heating element</i>)	PTC BROKEN	
A 104	PT4 broken (<i>sterilization chamber wall</i>)	PTC BROKEN	
A 111	PT1 short-circuited (<i>sterilization chamber</i>)	PTC SHORTCIRCUIT	
A 112	PT2 short-circuited (<i>steam generator</i>)	PTC SHORTCIRCUIT	
A 113	PT3 short-circuited (<i>heating element</i>)	PTC SHORTCIRCUIT	
A 114	PT4 short-circuited (<i>sterilization chamber wall</i>)	PTC SHORTCIRCUIT	
A200	Pre-heating not performed within the timeout (<i>heating resistor problem</i>).	HEATING PROBLEM	

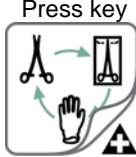
APPENDIX E – ALARMS

CODE	ALARM DESCRIPTION	LCD INDICATION	RESET MODE
A 250	1st vacuum pulse not reached within timeout	PV1 TIMEOUT	 <p>Press key (> 3 seconds)</p>
A 251	1st rise to atmospheric pressure not reached within timeout	ATM1 TIMEOUT	
A 252	1st pressure pulse not reached within timeout	PP1 TIMEOUT	
A 253	2nd vacuum pulse not reached within timeout	PV2 TIMEOUT	
A 254	2nd rise to atmospheric pressure not reached within timeout	ATM2 TIMEOUT	
A 255	2nd pressure pulse not reached within timeout	PP2 TIMEOUT	
A 256	3rd vacuum pulse not reached within timeout	PV3 TIMEOUT	
A 257	3rd rise to atmospheric pressure not reached within timeout	ATM3 TIMEOUT	
A 258	3rd pressure pulse not reached within timeout	PPP TIMEOUT	
A 259	Phase of PROCESS not started within timeout	PROCESS TIMEOUT	
A 260	Chamber depressurization not completed within timeout	PPD TIME-OUT	
HAZARDS (category H)			
H 150	MPX pressure sensor broken	MPX BROKEN	Turning-off device
H 160	MPX pressure sensor short-circuited/not connected	MPX SHORTCIRCUIT	
H 400	Ratio P_{conv}/T not balanced ($P_{conv}>T$) (Phase PROCESS)	P/T PROBLEM	 <p>Press key (> 3 seconds)</p>
H 401	Ratio T/P_{conv} not balanced ($T>P_{conv}$) (Phase PROCESS)	T/P PROBLEM	
H 402	Temperature above MAX limit (Phase PROCESS)	T OVER LIMIT	
H 403	Temperature below MIN limit (Phase PROCESS)	T UNDER LIMIT	
H 404	Temperature fluctuating over the limit (Phase PROCESS)	PT1 FLUCTUATING	
H 405	Pressure above MAX limit (Phase PROCESS)	P OVER LIMIT	
H 406	Pressure below MIN limit (Phase PROCESS)	P UNDER LIMIT	
H 410	Wrong maintenance time (Phase PROCESS)	TIMING PROBLEM	
H 990	Excessive pressure (sterilization chamber, MPX)	OVERPRESSURE	
H 991	Overheating (sterilization chamber, PT1)	OVERHEATING PT1	
H 992	Overheating (steam generator, PT2)	OVERHEATING PT2	
H 993	Overheating (band heating element, PT3)	OVERHEATING PT3	

ANALYSIS AND RESOLUTION OF PROBLEMS

Based on the **type of alarm**, below we provide instructions for identifying the possible causes and restoring correct operation:

CODE	POSSIBLE CAUSE	PROPOSED SOLUTION
ERRORS (category E)		
E 000	Sudden power failure (blackout).	Wait for electricity to return and perform RESET following the instructions.
	Accidentally turning-off the main switch and/or pulling the plug out of the socket.	Reconnect the plug and/or power-on the device and perform RESET following the instructions.
	Mains fuses blown.	Replace with good fuses of equal nominal value. (See the <i>Summary Table</i> in Appendix A, Technical Characteristics). Turn-on the device and perform RESET following the instructions.
E 010	Door open (or not properly closed) at the start of the program (START).	Perform RESET following the instructions. Close the door properly and restart the program.
	Door position microswitch broken.	Contact the Technical Support Department (see Appendix Z).
E 020	Limit microswitch (CLOSED position) of the door lock mechanism broken.	Perform RESET following the instructions. Try to start the program a second time.
	Door lock system gear motor broken.	If the problem persists contact the Technical Support Department (see Appendix Z).
E 021	Limit microswitch (OPEN position) of the door lock mechanism broken.	Perform RESET following the instructions.
	Door lock system gear motor broken.	Contact the Technical Support Department (see Appendix Z).
E 030	Water level in the fill tank below minimum (MIN) level.	Perform RESET following the instructions. Top-off the water until the MAX level indicator comes on (or at least until MIN indicator goes off).
	MIN water level indicator broken.	Contact the Technical Support Department (see Appendix Z).
E 031	Water level in the drain tank (or possible optional external drain tank) over the MAX level.	Perform RESET following the instructions and empty the tank. If installed, empty the optional external tank, leaving water up to the level indicated.
	Wire of the optional external tank level indicator not connected to the device.	Perform RESET following the instructions. Connect the plug of the level indicator wire (coming from the optional external tank) to the female socket located on the back of the device.
	MAX water level indicator broken.	Contact the Technical Support Department (see Appendix Z).
E 041	Connection tube between the sterilizer and a possible external filling device is not correctly installed.	Perform RESET following the instructions. Check that the water supply tube is correctly and solidly connected to the relative connectors Eliminate all possible obstructions along the path of the tube.
	External filling container is empty.	Ensure the external filling container is filled with distilled water.
	Water filling pump broken.	Contact the Technical Support Department (see Appendix Z).
	Problem in the plumbing circuit.	
E 900	Air leaking through the gasket	Perform RESET following the instructions. Carefully clean the gasket with a clean cotton cloth dampened with water. Start the program again. If the gasket still leaks, replace the gasket.

APPENDIX E – ALARMS

CODE	POSSIBLE CAUSE	PROPOSED SOLUTION
E 900	Problem in the plumbing circuit.	Contact the Technical Support Department (see Appendix Z).
E 901	Excessive humidity in the sterilization chamber.	Perform RESET following the instructions. Carefully dry the inside of the sterilization chamber and start the program again.
	Air leaking through the gasket	Perform RESET following the instructions. Carefully clean the gasket with a clean cotton cloth dampened with water. Start the program again. If the gasket still leaks, replace the gasket.
	Problem in the plumbing circuit.	Contact the Technical Support Department (see Appendix Z).
E 902	Excessive humidity in the sterilization chamber.	Perform RESET following the instructions. Carefully dry the inside of the sterilization chamber and start the program again.
	Air leaking through the gasket	Perform RESET following the instructions. Carefully clean the gasket with a clean cotton cloth dampened with water. Start the program again. If the gasket still leaks, replace the gasket.
	Vacuum pump broken.	Contact the Technical Support Department (see Appendix Z).
	Problem in the plumbing circuit.	
E 999	Manual interruption of sterilization or test program. (Also see the Chapter 9 - "Running the Program")	Perform RESET following the instructions. Check that the load has been correctly sterilized , by reading the LCD display, before using the material.
ALARMS (category A)		
A 022	Limit microswitch(es) on the door lock mechanism broken.	Contact the Technical Support Department (see Appendix Z).
A 023	Limit microswitch(es) on the door lock mechanism broken.	
A 024	Limit microswitch(es) on the door lock mechanism broken.	
A 032	Connector of the water level indicators not connected.	
	Level indicator(s) broken.	
A 040	Lack of water in the external tank or Bravo Pure turned off (automatic filling).	Perform RESET following the instructions. Fill the tank with a sufficient quantity of water, remembering to periodically check the level , or turn on the Bravo Pure.
	Connection tube between the sterilizer and a possible external filling device not correctly installed.	Perform RESET following the instructions. Check that the water supply tube is correctly and solidly connected to the relative connectors. Eliminate all possible obstructions along the path of the tube.
	Water filling pump broken.	Contact the Technical Support Department (see Appendix Z).
A 101	Chamber temperature sensor (PT1) broken.	Contact the Technical Support Department (see Appendix Z).
A 102	Steam generator temperature sensor (PT2) broken.	
A 103	Heating element temperature sensor (PT3) broken.	
A 104	Chamber wall temperature sensor (PT4) broken.	

CODE	POSSIBLE CAUSE	PROPOSED SOLUTION	
A 111	Incorrect connection of the temperature sensor (sterilization chamber) to the connector.	Contact the Technical Support Department (see Appendix Z).	
	Temperature sensor short circuit (sterilization chamber).		
A 112	Incorrect connection of the temperature sensor (steam generator) to the connector.		
	Temperature sensor short circuit (steam generator).		
A 113	Incorrect connection of the temperature sensor (heating element) to the connector.		
	Temperature sensor short circuit (heating element).		
A 114	Incorrect connection of the temperature sensor (chamber wall) to the connector.		
	Temperature sensor short circuit (chamber wall).		
A 200	Intervention of the steam generator safety thermostat.		Manually rearm the thermostat(s) located on the back of the device (see the Chapter 3 - Product Overview)
	Intervention of the heating element safety thermostat.		Unscrew the black plastic protection cap, press the white button until you hear a click and replace the cap.
	Heating or steam generator heating element malfunction.	Turn-off (RESET) and then turn-on the device. If the problem persists contact the Technical Support Department (see Appendix Z).	
A 250	Presence of water or condensate in the sterilization chamber.	Perform RESET following the instructions. Carefully dry the inside of the sterilization chamber and start the program again. Do not put material impregnated with water, or liquids in general, in the chamber.	
	Drain filter of the sterilization chamber obstructed.	Clean or replace the drain filter. (See Appendix C "Maintenance").	
	Air leaking through the gasket.	Perform RESET following the instructions. Carefully clean the gasket with a clean cotton cloth dampened with water. Start the program again. If the gasket still leaks, replace the gasket.	
	Vacuum pump broken.	Contact the Technical Support Department (see Appendix Z).	
	Problem in the plumbing circuit.		
A 251	Water injection pump malfunction.	Contact the Technical Support Department (see Appendix Z).	
	Problem in the plumbing circuit.		
	Intervention of the steam generator safety thermostat.	Manually rearm the thermostat(s) located on the back of the device (see the Chapter 3 - Product Overview). Unscrew the black plastic protection cap, press the white button until you hear a click and replace the cap. Turn-off (RESET) and then turn-on the device. If the problem persists, contact the Technical Support Department (see Appendix Z)	
	Heating element safety thermostat intervened.	Contact the Technical Support Department (see Appendix Z).	
	Heating or steam generator heating element malfunction.		

APPENDIX E – ALARMS

CODE	POSSIBLE CAUSE	PROPOSED SOLUTION
A 252	Steam leaking through the gasket.	Perform RESET following the instructions. Carefully clean the gasket with a clean cotton cloth dampened with water. Start the program again. If the gasket still leaks, replace the gasket.
	Excessive load.	Perform RESET following the instructions. Check the quantity of material in the sterilization chamber and make sure it does not exceed the maximum quantity allowed. (See the <i>Summary Table</i> in Appendix A, Technical Characteristics).
	Problem in the plumbing circuit.	Contact the Technical Support Department (see Appendix Z).
	Intervention of the steam generator safety thermostat.	<u>Manually rearm</u> the thermostat(s) located on the back of the device (see the Chapter 3 - Product Introduction). Unscrew the black plastic protection cap, press the white button until you hear a click and replace the cap. Turn-off (RESET) and then turn-on the device. If the problem persists, Contact the Technical Support Department (see Appendix Z).
	Heating element safety thermostat intervened.	Contact the Technical Support Department (see Appendix Z).
Heating or steam generator heating element malfunction.		
A 253	Presence of water or condensate in the sterilization chamber.	Perform RESET following the instructions. Carefully dry the inside of the sterilization chamber and start the program again. Do not put material impregnated with water, or liquids in general, in the chamber.
	Air leaking through the gasket.	Perform RESET following the instructions. Carefully clean the gasket with a clean cotton cloth dampened with water. Start the program again. If the gasket still leaks, replace the gasket.
	Vacuum pump broken.	Contact the Technical Support Department (see Appendix Z).
	Problem in the plumbing circuit.	
A 254	Water injection pump malfunction.	Contact the Technical Support Department (see Appendix Z).
	Problem in the plumbing circuit.	
	Intervention of the steam generator safety thermostat.	<u>Manually rearm</u> the thermostat(s) located on the back of the device (see the Chapter 3 - Product Overview). Unscrew the black plastic protection cap, press the white button until you hear a click and replace the cap. Turn-off (RESET) and then turn-on the device. If the problem persists, contact the Technical Support Department (see Appendix Z).
	Heating element safety thermostat intervened.	Contact the Technical Support Department (see Appendix Z).
	Heating or steam generator heating element malfunction.	
A 255	Steam leaking through the gasket.	Perform RESET following the instructions. Carefully clean the gasket with a clean cotton cloth dampened with water. Start the program again. If the gasket still leaks, replace the gasket.

CODE	POSSIBLE CAUSE	PROPOSED SOLUTION
A 255	Excessive load.	Perform RESET following the instructions. Check the quantity of material in the sterilization chamber and make sure it does not exceed the maximum quantity allowed. (See the <i>Summary Table</i> in Appendix A, Technical Characteristics).
	Problem in the plumbing circuit.	Contact the Technical Support Department (see Appendix Z).
A 255 (continue)	Intervention of the steam generator safety thermostat.	<u>Manually rearm</u> the thermostat(s) located on the back of the device (see the Chapter 3 - Product Overview). Unscrew the black plastic protection cap, press the white button until you hear a click and replace the cap. Turn-off (RESET) and then turn-on the device. If the problem persists, Contact the Technical Support Department (see Appendix Z).
	Heating element safety thermostat intervened.	Contact the Technical Support Department (see Appendix Z).
	Heating or steam generator heating element malfunction.	
A 256	Presence of water or condensate in the sterilization chamber.	Perform RESET following the instructions. Carefully dry the inside of the sterilization chamber and start the program again. Do not put material impregnated with water, or liquids in general, in the chamber.
	Air leaking through the gasket.	Perform RESET following the instructions. Carefully clean the gasket with a clean cotton cloth dampened with water. Start the program again. If the gasket still leaks, replace the gasket.
	Vacuum pump broken.	Contact the Technical Support Department (see Appendix Z).
	Problem in the plumbing circuit.	
A 257	Water injection pump malfunction.	Contact the Technical Support Department (see Appendix Z).
	Problem in the plumbing circuit.	
	Intervention of the steam generator safety thermostat.	<u>Manually rearm</u> the thermostat(s) located on the back of the device (see the Chapter 3 - Product Overview). Unscrew the black plastic protection cap, press the white button until you hear a click and replace the cap. Turn-off (RESET) and then turn-on the device. If the problem persists, Contact the Technical Support Department (see Appendix Z).
	Heating element safety thermostat intervened.	Contact the Technical Support Department (see Appendix Z).
	Heating or steam generator heating element malfunction.	
A 258	Steam leaking through the gasket.	Perform RESET following the instructions. Carefully clean the gasket with a clean cotton cloth dampened with water, and start the program again. If the gasket still leaks, replace the gasket.
	Excessive load.	Perform RESET following the instructions. Check the quantity of the material in the sterilization chamber and make sure that it does not exceed the maximum allowed quantity, depending on the type of load. (See the <i>Summary Table</i> in Appendix A, Technical Characteristics).
	Problem in the plumbing circuit.	Contact the Technical Support Department (see Appendix Z).

APPENDIX E – ALARMS

CODE	POSSIBLE CAUSE	PROPOSED SOLUTION
A258	Intervention of the steam generator safety thermostat.	<p><u>Manually rearm</u> the thermostat(s) located on the back of the device (see the Chapter 3 - Product Overview).</p> <p>Unscrew the black plastic protection cap, press the white button until you hear a click and replace the cap.</p> <p>Turn-off (RESET) and then turn-on the device.</p> <p>If the problem persists, Contact the Technical Support Department (see Appendix Z).</p>
	Heating element safety thermostat intervened.	<p>Contact the Technical Support Department (see Appendix Z).</p>
	Heating or steam generator heating element malfunction.	
A 259	Excessive load.	<p>Perform RESET following the instructions.</p> <p>Check the quantity of the material in the sterilization chamber and make sure that it does not exceed the maximum allowed quantity, depending on the type of load.</p> <p>(See the <i>Summary Table</i> in Appendix A, Technical Characteristics).</p>
	Steam leaking through the gasket.	<p>Perform RESET following the instructions.</p> <p>Carefully clean the gasket with a clean cotton cloth dampened with water, and start the program again. If the gasket still leaks, replace the gasket.</p>
	Problem in the plumbing circuit.	<p>Contact the Technical Support Department (see Appendix Z).</p>
A 260	Problem in the plumbing circuit.	<p>Contact the Technical Support Department (see Appendix Z).</p>
HAZARDS (category H)		
H 150	Pressure sensor (MPX) broken.	<p>Contact the Technical Support Department (see Appendix Z).</p>
H 160	Incorrect connection of the pressure sensor (MPX) to the connector.	
	Pressure sensor (MPX) short circuit.	
H 400	Problem in the plumbing circuit.	
H 401	Problem in the plumbing circuit.	
H 402	Steam generator malfunction.	
	Problem in the plumbing circuit.	
H 403	Steam generator malfunction.	
	Problem in the plumbing circuit.	
H 404	Problem in the plumbing circuit.	
	Steam generator malfunction.	
H 405	Problem in the plumbing circuit.	
	Steam generator malfunction.	
H 406	Problem in the plumbing circuit.	
	Steam generator malfunction.	
H 410	Timer problem	
H 990	General operating problem.	
H 991	General operating problem.	
H 992	General operating problem.	
H 993	General operating problem.	

APPENDIX F – DIAGRAMS

ELECTRICAL DIAGRAM

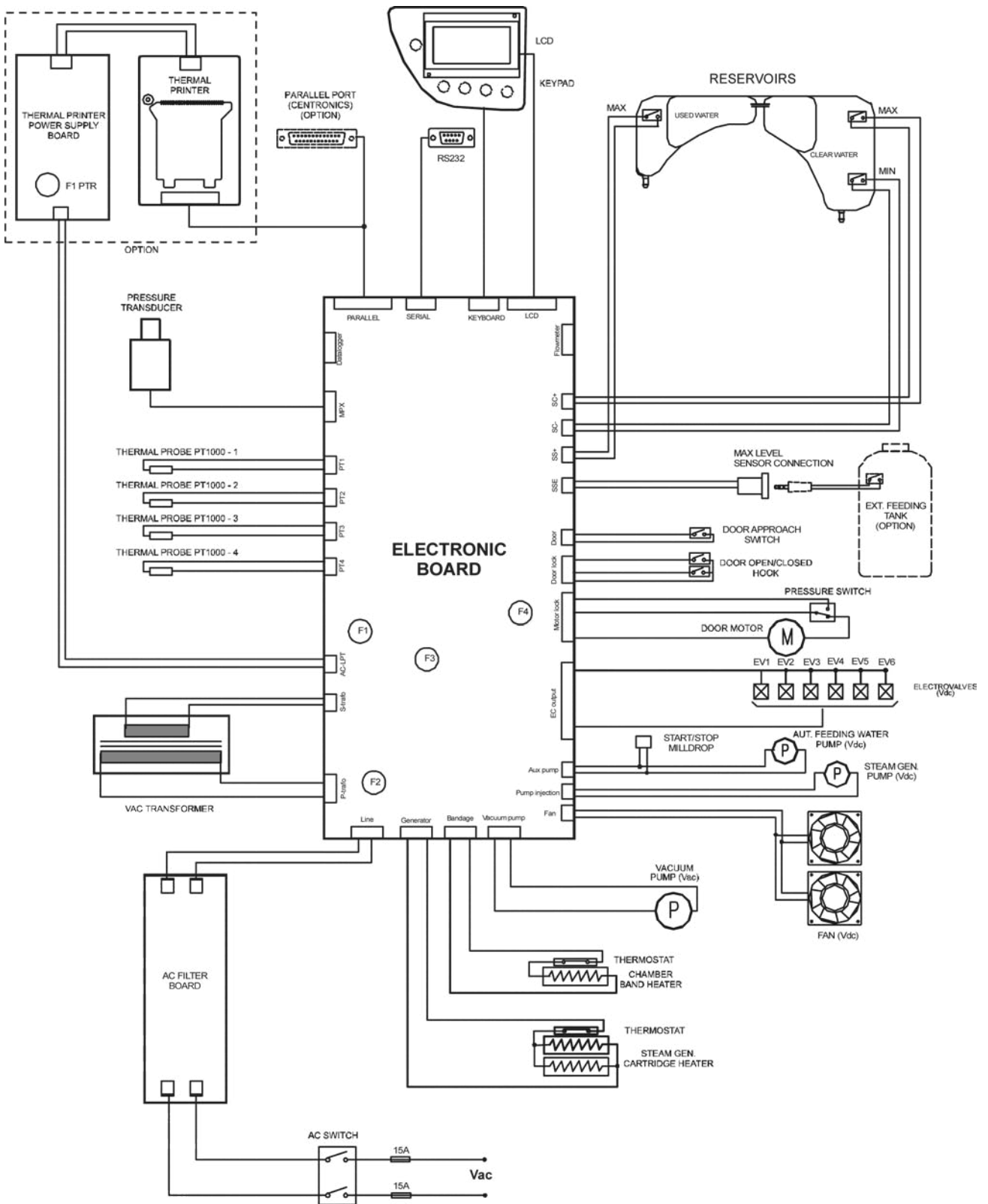

PLUMBING DIAGRAM

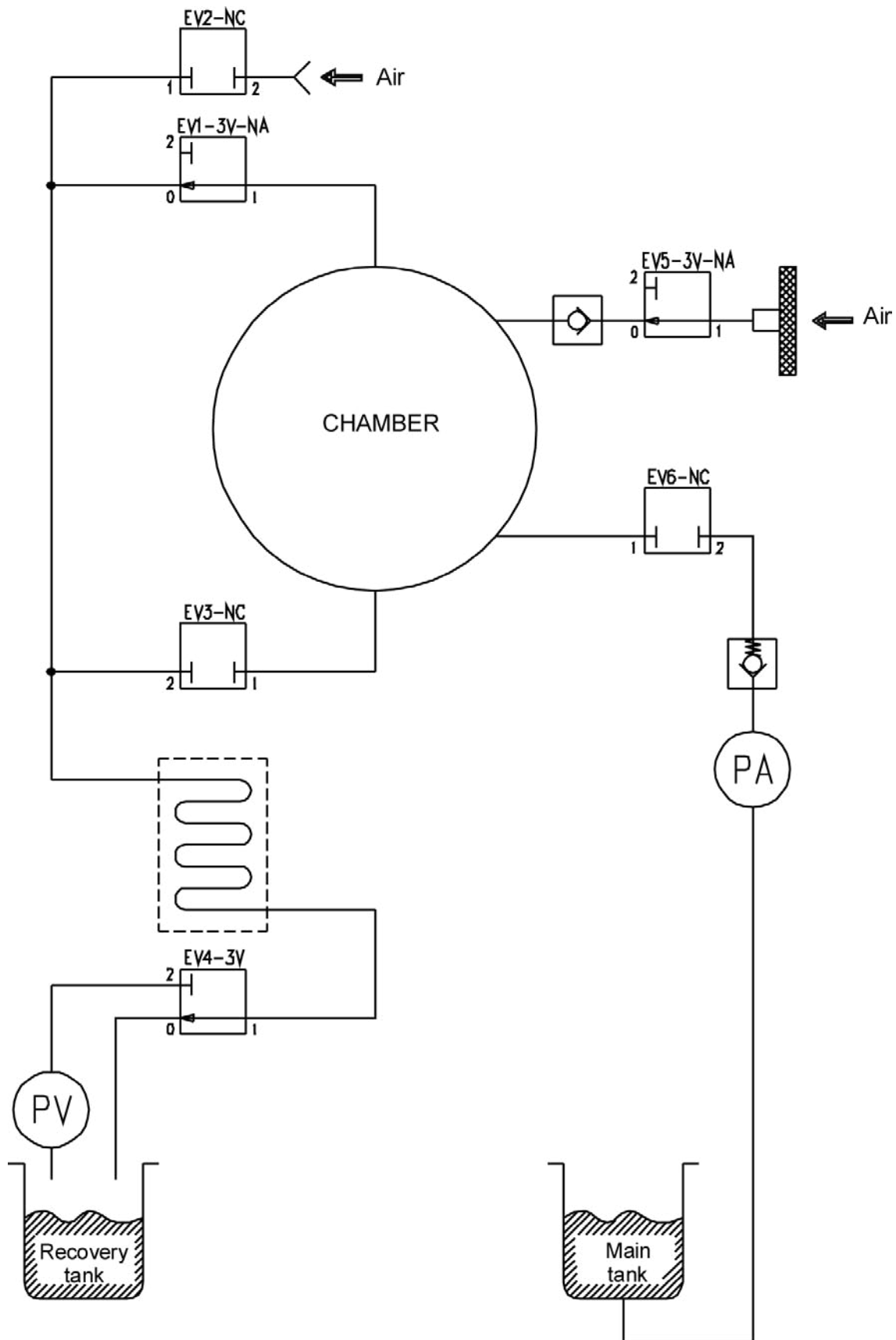

APPENDIX H – SPARE PARTS & ACCESSORIES

Description	Part Number
Door Gasket, Bravo	48000050000
Biological Filter, Bravo	47200010000
Chamber Drain Filter, Bravo	47200030000
Thermal Paper	STXX0250000
Data Logger (G), Bravo	01-111729
Data Logger (T), Bravo	01-111730
Water In-Take Pull Kit, Bravo	01-111774S
Direct-to-Drain Kit, Bravo	01-111775S
Rack Chamber, Bravo 17(V)	C1BP583000Y
Rack Chamber, Bravo 21V	C1BG534000Y
Tray 17/17V, Bravo	C1BP583000Y
Tray 21V, Bravo	C1BG534000Y
Pouch Rack, Bravo	C1BP553000Y
Tray Extractor, Bravo	STXX0080000
Drain Pipe, Bravo	110000003W0
Water Filling Jug	A0XP0010000
Mounting Feet, Bravo	25600000400

APPENDIX I – TECHNICAL SUPPORT

For all service and repair inquiries:

Canada 1-800-870-7777

United States: 1-800-572-1211

International: +1 (416) 446-4500

Email: techservice.ca@scican.com (Canada)

techservice.us@scican.com (USA)

techservice.int@scican.com (International)

APPENDIX J – LIMITED WARRANTY

For a period of two years or 2500 cycles, which ever appears first, SciCan guarantees that the Bravo Autoclave, when manufactured by SciCan in new and unused condition, will not fail during normal service due to defects in material and workmanship that are not due to apparent abuse, misuse, or accident.

The two year warranty will cover the performance of all components of the unit except consumables such as the door seal, microbiological filter, water filter, wire racks and trays, provided that the product is being used and maintained according to the description in the operator's manual.

In the event of failure due to such defects during this period of time, the exclusive remedies shall be repaired or replaced, at SciCan's option and without charge, of any defective non-consumable part(s) (except gasket), provided SciCan is notified in writing within thirty (30) days of the date of such a failure and further provided that the defective part(s) are returned to SciCan, prepaid.

This warranty shall be considered to be validated if the product is accompanied by the original purchase invoice from the authorized SciCan dealer, and such invoice identifies the item by serial number and clearly states the date of purchase. No other validation is acceptable. After two years or 2500 cycles, all SciCan's warranties and other duties with respect to the quality of the product shall be conclusively presumed to have been satisfied. All liability therefore shall be terminated, and no action or breach of any such warranty or duty may thereafter be commenced against SciCan.

Any express warranty not provided hereon and any implied warranty or representation as to performance, and any remedy for breach of contract which, but for this provision, might arise by implication, operation of law, custom or trade or course of dealing, including any implied warranty of merchantability or of fitness for particular purpose with respect to all and any products manufactured by SciCan is excluded and disclaimed by SciCan.

If you would like to learn more about SciCan products and features, visit our website at www.scican.com

