



RESPIRONICS®

www.respironics.com



SETUP & USER'S GUIDE

Alice® 5

The Alice® 5 system is covered by the following patent: U.S. Patent No. 6,425,861.

The information contained in this document is the property of Respiroics, Inc. Except as specifically authorized in writing by Respiroics, the holder of this document (1) shall keep all information contained herein confidential and shall protect same in whole or in part from disclosure and dissemination to all third-parties, and (2) shall use same for operation and maintenance purposes only.

All information contained in this document is subject to change without notice. Respiroics reserves the right to make changes to equipment design or program components, as progress in engineering, manufacturing methods, or other circumstances may warrant.

Alice®, Respiroics®, and the Respiroics logo are registered trademarks of Respiroics, Inc.

All other trademarks are owned by their respective companies.

Table of Contents

Chapter 1: Introduction	1-1
1.1 Alice 5 System Contents	1-2
1.2 Warnings and Cautions	1-4
1.2.1 Warnings	1-4
1.2.2 Cautions	1-5
1.3 Intended Use	1-6
1.4 Hardware Component Overview	1-7
1.4.1 Data Flow through the Alice 5 Components	1-7
1.4.2 Alice 5 Base Station	1-9
1.4.2.1 Base Station Rear Panel	1-11
1.4.3 Headbox	1-14
1.5 Symbol Key	1-16
1.5.1 Headbox Symbols	1-16
1.5.2 Base Station Back Panel Symbols	1-17
1.5.3 Base Station Control Panel Symbols	1-18
1.6 Acronyms and Definitions	1-18
1.7 Contacting Customer Service	1-21
Chapter 2: Alice 5 Equipment Setup	2-1
2.1 Before You Begin	2-2
2.2 Setting Up Your Network	2-2
2.2.1 Network Setup Examples	2-2
2.2.2 Using a Point-to-Point Setup	2-5
2.2.2.1 Map Your Facility's Network Setup	2-6
2.2.3 Using a Wired Network Setup	2-7
2.2.4 Using an Access Point Infrastructure Network	2-8
2.2.5 Connecting the Alice 5 Hardware Components	2-10
2.3 Integrating Alice 3 and Alice 4 Devices into your Alice 5 Network	2-16
2.4 Adding Accessories	2-17
2.4.1 Installing Video Cameras and/or Video Servers	2-17
Chapter 3: Software Installation and Setup	3-1
3.1 Alice Sleepware Software Installation	3-2
3.2 Adding Alice Devices	3-6
3.2.1 Adding an Alice 5 Device	3-6

Chapter 4: Running Data Acquisitions	4-1
4.1 Overview	4-1
4.2 Patient Setup	4-2
4.2.1 Attaching EEG Electrodes	4-3
4.2.2 Attaching ECG Electrodes	4-6
4.2.3 Attaching Chest and Abdomen Effort Sensors	4-8
4.2.4 Attaching the EOG and EMG Electrodes	4-9
4.2.4.1 EOG Electrodes	4-9
4.2.4.2 Leg EMG Electrodes	4-9
4.2.4.3 Chin EMG Electrodes	4-9
4.2.5 Attaching the Airflow Sensor	4-10
4.3 Starting an Acquisition	4-11
4.3.1 Check Your Cable Connections	4-11
4.3.2 Check Your Equipment Performance	4-12
4.3.2.1 Check Impedance Using the Alice Sleepware	4-12
4.3.2.2 Check Calibration	4-13
4.3.3 Starting an Acquisition	4-15
4.2.4 Stopping an Acquisition	4-16
Chapter 5: Understanding Channels	5-1
5.1 Headbox Channels	5-2
5.2 Base Station Auxiliary Channels	5-10
5.2.1 Display Properties of Auxiliary Input Channels	5-10
Graphic Display Type	5-11
Grapho-Numeric Display Type	5-11
Numeric Display Type	5-12
5.2.2 Base Station Auxiliary Channel Descriptions	5-12
5.3 Therapy Device Channels	5-14
5.4 Derived Channels	5-17
Chapter 6: Cleaning and Maintenance	6-1
6.1 Base Station, Headbox, and Patient Cable	6-1
6.2 Sensors	6-2
6.2.1 EEG Electrodes	6-2
6.2.2 ECG Sensors	6-2
6.2.3 Airflow Sensors	6-2
6.2.4 Snore, Actimeter, and Body Position Sensors	6-2
6.2.5 Effort Belts	6-2
Chapter 7: Troubleshooting	7-1
Chapter 8: Specifications	8-1
8.1 Device Size	8-1
8.2 Classifications and Ratings	8-2
8.3 Disposal	8-3
Appendix A: EMC Information	A-1
Guidance and Manufacturer's Declaration - Electromagnetic Emissions	A-1
Guidance and Manufacturer's Declaration - Electromagnetic Immunity	A-2

Introduction

The *Alice® 5 Setup and User's Guide* contains instructions on how to set up your Alice 5 equipment so you can successfully run your sleep studies. It provides detailed information on:

- Alice 5 equipment setup
- Alice Sleepware software installation
- Alice 5 equipment user instructions

Refer to the following Alice manuals for additional information:

- The *Alice® Sleepware™ User's Guide* contains information on how to use the diagnostic software and describes the reporting features within Sleepware.
- The *Respironics Diagnostic Accessory Guide* contains information about additional accessories you can use with your Alice system.

Electronic copies of the user's guides are available on the Alice Sleepware Software CD-ROM in PDF format.

1.1 Alice 5 System Contents

The Alice 5 system contains the following hardware components, shown in Figure 1–1:

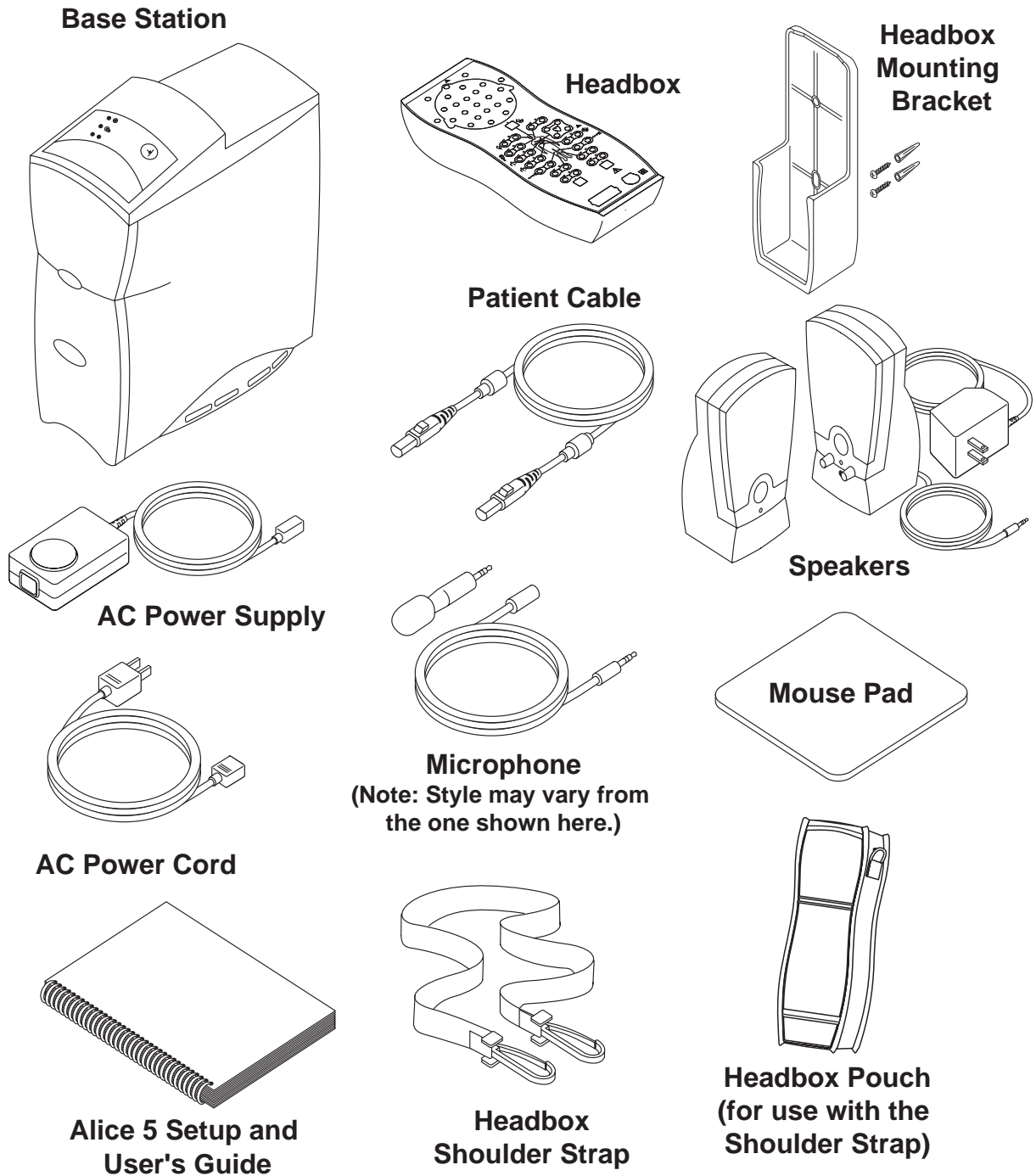

Figure 1–1 Alice 5 Package Contents

You may want to purchase additional accessories with your Alice 5 system. The following is a general list of accessories available. For a complete list, contact Respiroics Customer Service or your Respiroics representative.

- Computer workstations
- Laptop computers
- Computer speakers
- Computer microphones
- Effort sensors
- Oximeter probes
- ECG Leads
- Additional User Guides
- Computer monitors
- Ethernet cards
- Network switches
- Cables
- Oximeter sensors
- Cannula
- Video (web-server, cameras)

Note: *For more details on the accessories available, see the Respiroics Diagnostic Accessory Guide.*

Note: *It is recommended that you purchase the computer equipment you will use with the Alice system through Respiroics to ensure the performance of the Alice Sleepware software. Customers do have the option of procuring their own equipment, but Respiroics cannot guarantee the performance of Alice Sleepware on systems not tested by Respiroics. For recommended computer specifications, see the Alice Sleepware software packaging.*

Note: *Computers used with the Alice 5 system must be UL 1950, IEC 60950, or EN 60950 approved.*

Note: *The style of the microphone, speakers, and some accessories such as the video camera may differ from the ones shown in illustrations in this manual.*

1.2 Warnings and Cautions

Caution: *US federal law restricts this device to sale by or on the order of a licensed healthcare practitioner. This product should be used only under the supervision of a physician.*

1.2.1 Warnings

The following warnings indicate the possibility of injury to the patient or the operator.

- Be aware of signal interference, which can occur from external sources. Electronic signals are required for the Alice 5 to function. Even though the system contains methods and techniques that can provide protection from external sources of interference, you should operate the system as follows:
 - Do not plug sensor lead wires into electrical outlets. Lead wire contact with electrical outlets presents a serious shock hazard.
 - Place the system components on a sturdy and level surface. Do not place the base station on carpeting.
 - Do not use the Alice 5 system within three feet of oxygen tanks or oxygen tents.
 - Do not operate the Alice 5 system in any explosive situation where flammable or explosive sources are operational and in use.
 - If you suspect that the system is not working properly, do not attempt to service it. Contact your equipment provider or Respirationics for assistance.
 - Always unplug the components from all electrical power sources (AC) when cleaning the system or any of its accessories. To remove AC power, unplug the power supply cord from the mains outlet.
 - Do not connect telephone equipment to the auxiliary inputs.
- If a patient has a cardiac pacemaker, consult with the patient's physician prior to performing the study.
- The Alice 5 device and its accessories are not protected against the effect of cardiac defibrillation. Remove all patient leads (applied parts) before performing cardiac defibrillation.
- Do not use the Alice 5 system in a Magnetic Resonance Imaging (MRI) environment or in close proximity to a high emissions source.
- Do not touch the base station and the patient simultaneously, as this may create an electrical shock hazard.
- Periodically inspect the electrical cords, cables, and the power supply device for damage or signs of wear. Discard and replace any damaged parts before using.

- Make sure that any wires attached to the patient are routed to reduce the likelihood of strangulation.
- Pins of connectors identified with the ESD warning symbol should not be touched. Connections should not be made to these connectors unless ESD precautionary procedures are used. Precautionary procedures include methods to prevent buildup of electrostatic discharge (e.g., air conditioning, humidification, conductive floor coverings, and non-synthetic clothing), discharging one's body to the frame of the equipment or system or to earth or a large metal object, and bonding oneself by means of a wrist strap to the equipment or system, or to earth.
- The conductive parts of electrodes and associated connectors, including the neutral electrode, should not contact other conductive parts, including earth.
- Do not use during high frequency surgical procedures or electrosurgery.

1.2.2 Cautions

The following cautions indicate the possibility of damage to the device.

- For all equipment used with the Alice 5 system, follow all of the manufacturer's recommendations and instructions. Be sure to read, understand, and follow the instructions in this manual and others that come with the system and its components. If you don't have a manual, ask the equipment distributor or manufacturer for one.
- Operation of the Alice system may be adversely affected by:
 - electromagnetic fields exceeding the level of 10 V/m in the test conditions of EN 60601-1-2
 - the operation of high frequency (diathermy) equipment
 - defibrillators, or short wave therapy equipment
 - radiation (e.g., x-ray, CT)
 - magnetic fields (e.g., MRI)
- Synthetic fabric from draperies or rugs can also cause interference due to static electricity. Touching an inanimate object (e.g., wall, crib) before handling the patient or the system often prevents static build-up problems.
- Strong transmitter signals from TV, radio, airport, police, fire, and ambulance stations could be received and interpreted as heart and/or breath signals. If you are located less than one mile from any of these sources, ask Respironics Customer Service to assist you in determining whether your system will operate properly.
- Do not soak or immerse the base station or headbox in any liquid.
- Never use an extension cord with the Alice 5 system. Always operate the device using a properly grounded AC power outlet. If you are unsure whether a power outlet is properly grounded, contact an electrician for assistance.

- Do not place liquids on or near the Alice 5 system. If liquids are spilled on the equipment, discontinue use until it can be determined that the device can be safely operated. Contact Respironics for assistance.
- Do not operate the Alice 5 system during electrical storms. Information could be lost or damaged.
- Do not drop components of the Alice 5 system. If any of the devices are dropped, discontinue use until it can be determined that the device is fully operational. Contact Respironics for assistance.
- Report problems with any of the components of the Alice 5 system. If the system is not working properly, contact Respironics immediately for service.
- Use only accessories that have been approved by Respironics.

1.3 Intended Use

The Alice 5 system is a single-patient use, polysomnography system that is intended to record, display, and print physiological information for clinicians or physicians. These parameters are presented graphically on a computer screen for diagnostic review, similar in application to the use of a traditional paper-based polygraph recorder. The device will be used in hospitals, institutions, sleep center or clinics, or other test environments where adults or infant patients require the documentation of various sleep or other physiological disorders.

This device does not provide alarms and is not intended for use as an automated apnea monitor. It is not for continuous monitoring.

The Alice 5 equipment collects the data from sensors placed on a patient and delivers the data to a computer running the Sleepware application. The Alice Sleepware application is a Windows-based software program designed to monitor, display, process, and download polysomnographic data recorded with the Alice 5 equipment.

Note: *For information about using Microsoft Windows, refer to your Microsoft documentation. For more information about Alice Sleepware, refer to the Alice Sleepware User's Guide.*

1.4 Hardware Component Overview

The Alice 5 equipment consists of the base station, headbox, polysomnographic sensors, and auxiliary input devices.

The base station and headbox record, amplify, filter, and digitize various physiologic inputs. It may collect up to 55 channels of data. The base station stores the data locally on an internal hard disk until it is sent over a wired or wireless ethernet connection to a computer running the Alice Sleepware application. Sleepware can display live or pre-recorded data in a resolution consistent with the computer hardware specifications. Sound and video of the patient are available, and an intercom feature allows you to communicate with the patient remotely.

The base station can also interface directly with several auxiliary input devices (e.g., EtCO₂ monitors, etc.).

The two main components of your Alice 5 system are the base station and headbox. You can add additional hardware components, such as video cameras, if needed. See Chapter 2 for information on how to set up video cameras. For information on additional Alice 5 accessories, refer to the *Respironics Diagnostic Accessory Guide*.

1.4.1 Data Flow through the Alice 5 Components

The flow of the data through the Alice 5 system is as follows: From the patient, the sensors pick up physiologic events. Sensor cables carry the signal to the Alice 5 headbox or to an auxiliary device.

If the data then gets carried to the Alice 5 base station via the headbox, the signal is amplified and treated before being transformed from analog to digital format. If the signal is sent to the base station via an auxiliary input, it is not amplified by the base station because it was already amplified and conditioned in the auxiliary unit.

The signals are digitized and stored in the base station. If configured, they are then sent from the base station to the computer running the Alice Sleepware diagnostic application.

Figure 1–2 illustrates the flow of data during an Alice 5 acquisition.

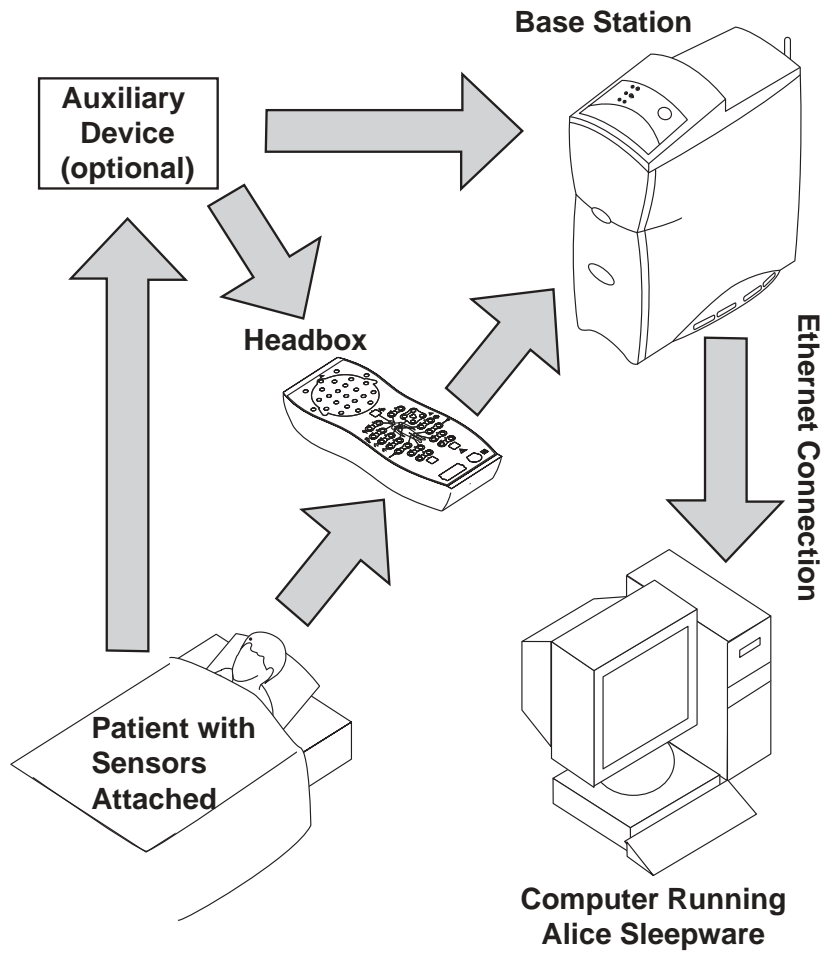

Figure 1–2 Data Flow During an Alice 5 Acquisition

1.4.2 Alice 5 Base Station

The Alice 5 base station is a completely self-contained data collection device that is capable of gathering and storing information without the use of an outside computer.

The base station should be placed on a flat, stable surface close enough to allow for easy connection to the headbox. The device should also be placed within easy access to an external AC power source that is properly grounded.

Figure 1-3 shows the base station and its control panel.

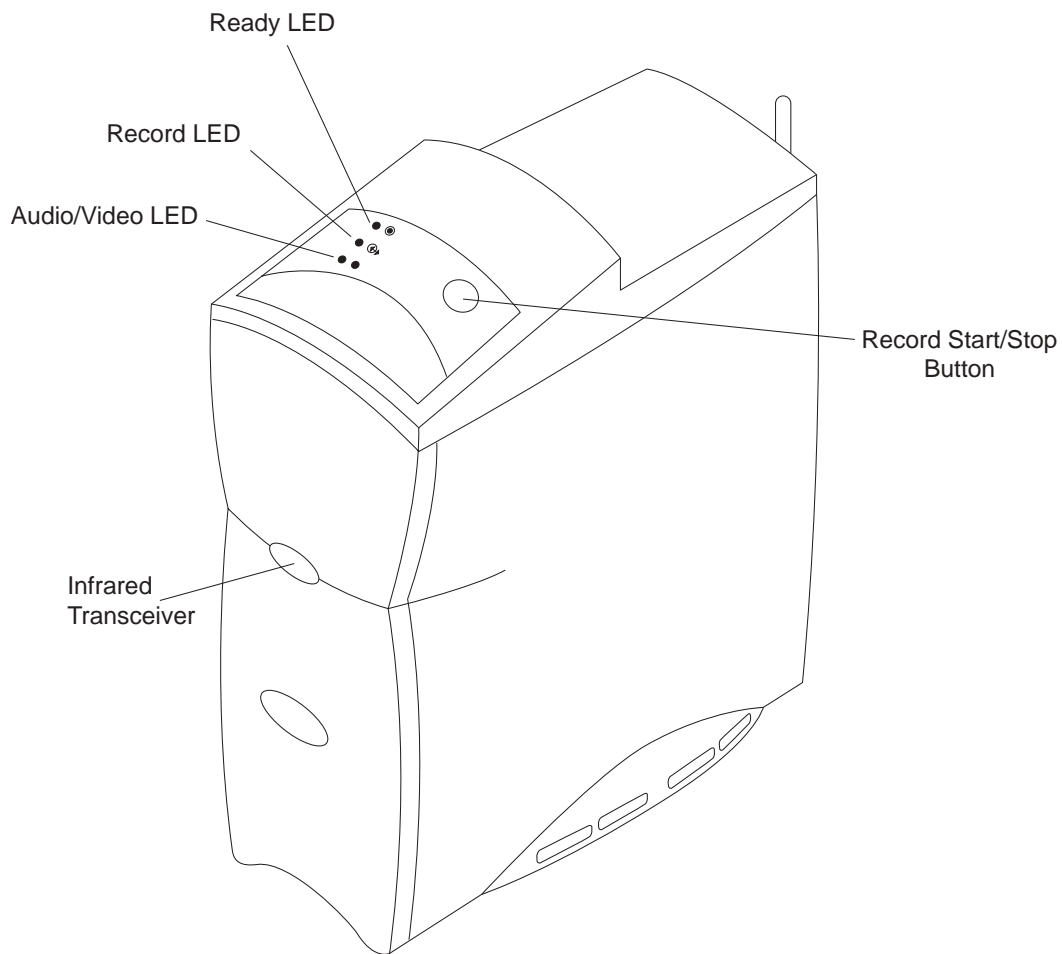

Figure 1-3 Alice 5 Base Station

The control panel at the top of the base station has three LEDs:

1. **Ready** – The top LED is the power indicator and has the following states:
 - Green – Indicates that power has been applied to the base station and it is ready for operation.
 - Yellow – Indicates that power has been applied to the base station, but it is not ready for operation.
 - Off – Indicates that power has not been supplied to the device.
2. **Record** – The center LED is the acquisition indicator and has the following states:
 - Green – Indicates that a study is being recorded and there are no errors on the base station or the headbox.
 - Flashing Yellow – Indicates that the headbox has been disconnected while a study is in progress. In this state, the base station records zeros until the headbox is reconnected.
 - Off – Indicates that data is not being captured or recorded (i.e., a study is not in progress).
3. **Audio/Video** – The bottom LED is the camera/microphone recording indicator and has the following states:
 - Green – Indicates that video and/or sound is active or being recorded.
 - Off – Indicates that video and sound are not active or being recorded.

In addition to the LEDs above, the control panel also includes the following button:

- **Record Start/Stop** – You can use this button to start or stop a data acquisition directly from the base station. If you start an acquisition at the base station, the name and ID of the previous patient is used, and the default configuration is recorded. For more information on data acquisitions, see Chapter 4.

Note: *Data acquisitions can also be started from a computer running Alice Sleepware. When starting acquisitions from a computer, you can enter specific patient information.*

The **Infrared Transceiver** on the front of the base station (shown in Figure 1–3) allows the base station to communicate with a laptop computer. If you are using a laptop that does not have a wireless card, the laptop can still communicate with the base station if it has infrared (IRDA) capability.

1.4.2.1 Base Station Rear Panel

Figure 1–4 shows the base station’s rear panel and its connections.

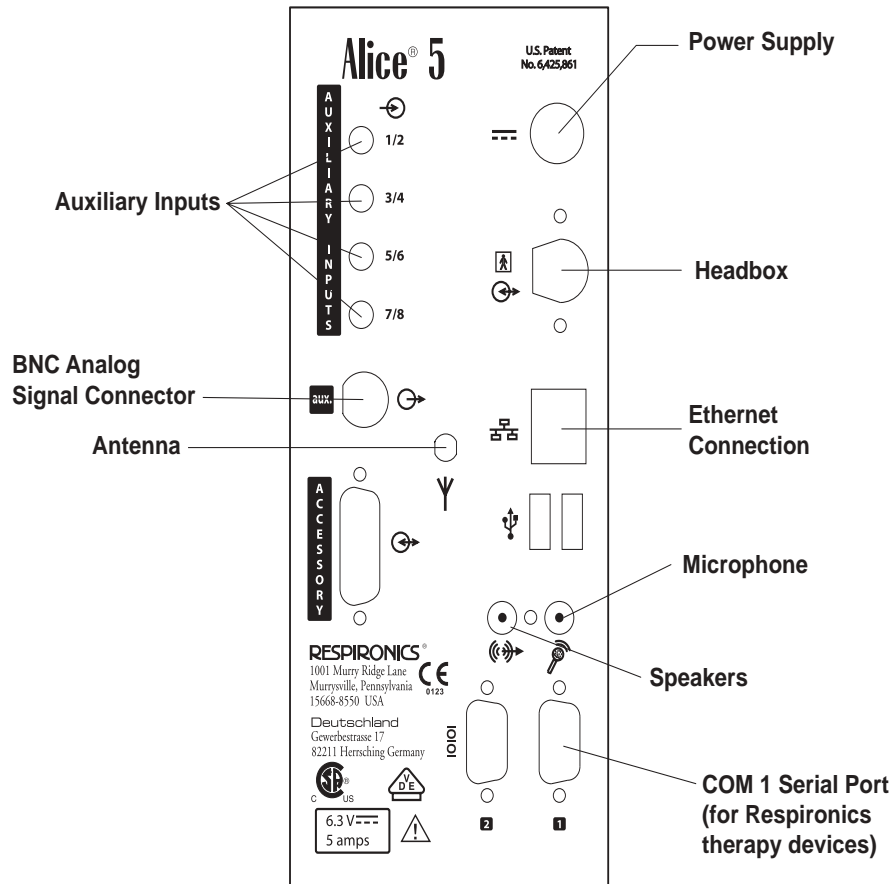



Figure 1–4 Base Station Rear Panel

Note: All other connections on the rear panel, including USB ports (USB), the Accessory port, and the Com 2 Serial Connection port are not currently used.

Note: Do **not** connect a video camera to the **aux.** port on the back of the base station. This is a BNC analog signal connector, not a video input connector.

On the back of the base station, there are two LEDs located on the ethernet connection (): Network Present and Network Traffic. These LEDs function for both wired and wireless networks.

1. **Network Traffic LED** – The bottom LED has the following states:
 - Flashing Green – Indicates that there is traffic on the network.
 - Off – Indicates that there is no traffic on the network.
2. **Network Present LED** – The top LED has the following states:
 - Flashing Yellow – Indicates that the only connection is to a wireless network.
 - Green – Indicates that the network is a wired network.
 - Off – Indicates that a network is not present.

Auxiliary Input Ports

You can connect additional external medical devices using the auxiliary inputs on the back of the base station. There are four ports available, but you can use a channel splitter to attach two devices to each input. See the *Respironics Diagnostic Accessory Guide* for additional information on using a channel splitter with the Alice 5.

The following table contains the pin-out information for the auxiliary input ports. The table is specific to auxiliary inputs 1 and 2, but you can use the same information for the remaining inputs (3/4, 5/6, etc.), respectively.

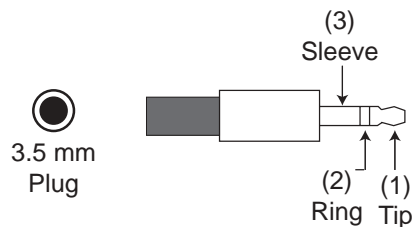

Auxiliary Ports 1 and 2

Pin Number	Pin Name	Input/Output/Power
1 Tip	Aux 2 Input (even)	In
2 Ring	Aux 1 Input (odd)	In
3 Sleeve	Rtn	GND

Serial Connection Port

You can connect Respironics CPAP or bi-level therapy devices to the Com 1 serial port on the back of the base station. The following table contains the proper pin-out information for the serial connection port.

Note: Contact Respironics Customer Service for a list of the therapy devices that are compatible with Alice 5.

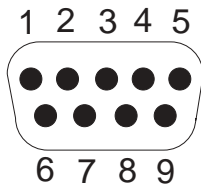

Pin Number	Pin Name	Input/Output/Power
1	CD	In
2	RxD	In
3	TxD	Out
4	DTR	Out
5	GND	GND
6	DSR	In
7	RTS	Out
8	CTS	In
9	RI	In

1.4.3 Headbox

The Alice 5 headbox combines the neurological inputs and cardio-respiratory inputs into a single device. These signals are then sent to the Alice 5 base station. You can place the headbox in several different locations:

- On a table or stand beside the patient's head.
- In the headbox mounting bracket attached to the wall behind the patient's head.
- Attached to a carrying strap that the patient can wear around the neck. This option is useful if the patient needs to get up during the study so the connectors do not need removed.
- In the headbox pouch attached to a shoulder strap worn over the patient's shoulder.

Figure 1–5 illustrates the options for headbox placement.

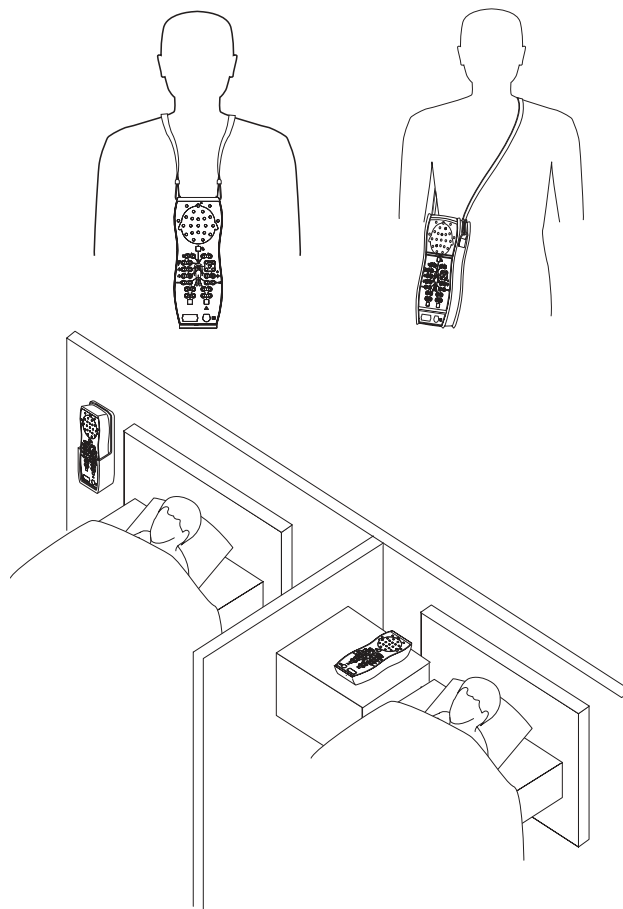

Figure 1–5 Headbox Placement Options

Figure 1–6 shows the Alice 5 headbox and defines the connections.

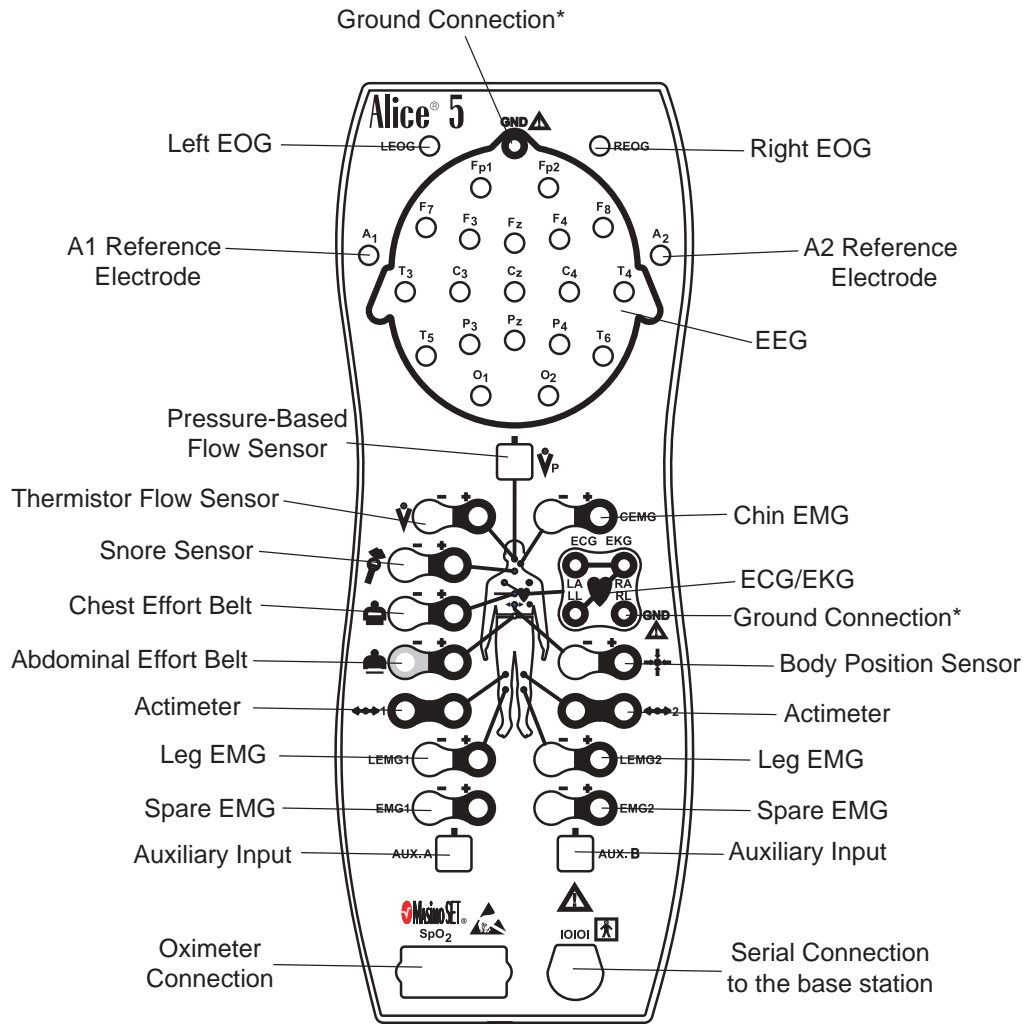

Figure 1–6 Alice 5 Headbox

*** Note:** *Although there are two ground (GND) connections, you can only use one ground connection at a time. You cannot use both simultaneously.*

Note: *For EEG inputs, connect the left reference electrode to the A1 input jack on the left side of the device. Connect the right reference electrode to the A2 input jack on the right side of the device.*

See Chapter 4 for more information on connecting sensors to the headbox.

















1.5 Symbol Key

The following symbols appear on the Alice 5 base station and headbox.





1.5.1 Headbox Symbols

Front		Back	
Symbol	Description	Symbol	Description
	Thermistor Flow Sensor		European CE Declaration of Conformity
	Pressure Based Flow Sensor		Notified Body Approval for Standards Compliance
	Snore Sensor (Vibration Sensor)		Canadian/US Certification
	Chest Effort Belt		Drip Proof Equipment
	Abdominal Effort Belt		
	Actimeter Sensor		
LEM1	Leg EMG Sensor		
EM1	Spare EMG Sensor		
AUX. A	Auxiliary Input Sensor		
SpO ₂	Oximeter Sensor		
IOIOI	Serial Connection to Base Station		
AUX. B	Auxiliary Input Sensor		
EM2	Spare EMG Sensor		
LEM2	Leg EMG Sensor		
	Actimeter Sensor		
	Body Position Sensor		
REOG	Right EOG Sensor		
LEOG	Left EOG Sensor		
GND	Ground		
ECG EKG	Electrocardiogram Sensor		
+	Positive		
-	Negative		
	Left Arm Sensor Left Leg Sensor Right Arm Sensor Right Leg Sensor		
	Attention, consult accompanying documents		
	Type BF Applied Part		
	Electrostatic Discharge		

1.5.2 Base Station Back Panel Symbols

Symbol	Description
	Input
	Output
	AC Power
	DC Power
	Input/Output (on back panel) (connect to headbox)
	Network
	Antenna
	USB Port (connector)
	Connect Speaker (out)
	Connect Microphone (in) Ambient Sound Recording and /or Intercom
IOIOI	Serial Connection to PC or CPAP
	Type BF Applied Part
	Class II (Double Insulated)
IPX0	Ordinary Equipment Rating
	European CE Declaration of Conformity
	Notified Body Approval for Standards Compliance
	Canadian/US Certification
	Attention, consult accompanying documents

1.5.3 Base Station Control Panel Symbols

Symbol	Description
	Record Start/Stop Button
	Ready (When green - Power is supplied, and the acquisition is ready to start) (When yellow - Power is supplied, but acquisition setup is not complete)
	Recording (When green - Acquisition is proceeding without errors) (When flashing yellow - Acquisition setup is not complete)
	Audio/Video (When green - Video / Audio is being recorded and/or the intercom is active)

1.6 Acronyms and Definitions

The following terms and acronyms appear in this manual:

Acquisition	A collection of polysomnographic data that has been acquired during a patient study.
Ad-Hoc Network	An Ad-hoc Wireless Local Area Network (WLAN) is a group of devices, each with a WLAN adaptor, connected as an independent wireless LAN.
Alice Sleepware	The Respironics software application that runs via the Windows operating system and that receives and analyzes physiologic data from Alice equipment.
Alice Sleepware Starter Bar	The component of the Alice Sleepware that appears at the top of the computer screen and is used during equipment setup for configuration and during data acquisitions to view settings or control the optional microphone and camera.
Base Station	Part of the Alice system equipment used to store polysomnographic data collected by the Alice headbox. This data can then be copied/moved to a computer for use with the Alice Sleepware software.
BiPAP	Bi-Level Positive Airway Pressure
CA	Central apnea – A temporary cessation of airflow accompanying a cessation of respiratory effort.

CPAP	Continuous Positive Airway Pressure
Configuration	The set of channels used to acquire polysomnographic data.
ECG	Electrocardiogram – A recording of cardiac electrical activity. In sleep testing, this channel is used to assess heart rate and rhythm.
EEG	Electroencephalogram – A recording of electrical brain activity. With the EMG and EOG, the EEG is one of three basic variables used to score wake and sleep and to identify sleep stages. The EEG is the primary variable for sleep staging.
EMG	Electromyogram – A recording of muscle electrical activity. The chin EMG is measured by surface electrodes, and along with the EEG and EOG, it is one of the three basic variables used to score wake and sleep and to identify sleep stages.
EOG	Electrooculogram – A recording of voltage changes resulting from shifts in position of the eye. Along with the EEG and EMG, the EOG is one of the three basic variables used to score wake and sleep and to identify sleep stages.
EPAP	Expiratory Positive Airway Pressure
EtCO ₂	End tidal carbon dioxide, as detected by an end tidal CO ₂ monitoring device.
Generic Channels	Channels whose data the Alice 5 does not have an auto-scoring algorithm for. Generic channels need definition regarding their presentation (display). Generic channels usually have as their source an auxiliary device connected to an auxiliary input on the Alice headbox. Generic channels may be displayed as numbers or graphs. There are three display types for generic channels: Graphic, Grapho-Numeric, and Numeric.
Graphic Display Type	One of three display types for generic channels. A graphic display type is assigned when a channel's data is most useful to the clinician when displayed as a graph (waveform) rather than a number, and the data points of the curve are not clinically useful. In other words, the curve, not its data points, are important.
Grapho-Numeric Display Type	One of three display types for generic channels. A grapho-numeric display type is assigned when a channel's data is most useful to the clinician when displayed as a graph (waveform) and the data points are also meaningful.
Headbox	A bedside remote amplifier that is part of the Alice system and is used to collect physiologic data from sensors placed on the patient's body.

Infrastructure Network	An integrated wireless and wired LAN is called an infrastructure configuration.
IPAP	Inspiratory Positive Airway Pressure
IR	Infrared
LAN	Local Area Network
LED	Light Emitting Diode
MAC Address	Media Access Control address. This is a unique hardware address that identifies a device on a network. It is assigned by the manufacturer and cannot be changed. This address can usually be found on the device packaging.
Montage	A montage (as distinguished from an acquisition configuration) is a way to display re-referenced EEG and EOG data during or after an acquisition. Each acquired EEG channel measures the difference in electrical potential between a given (active) electrode and a reference. The montage tool recombines EEG/EOG data in order to display the difference in potential between any two electrodes.
Numeric Display Type	One of the three display types for generic channels. A numeric display type is assigned when the data is most useful to the clinician when displayed as a number, rather than a waveform.
OSA	Obstructive Sleep Apnea – A temporary cessation of airflow without an accompanying cessation of respiratory effort.
pH	A measure of the acidity or alkalinity of a fluid. In sleep, this generally refers to a measure of the acidity of fluid in the esophagus, detected by an esophageal pH probe.
PLM	Periodic limb movement, indicated by the change in leg muscle tone as detected by the difference in electrical potential of two leg EMG leads.
Polysomnography	Recording of multiple channels of physiologic data during sleep.
PSG	Polysomnography
PTT	Pulse Transit Time
REM	Rapid Eye Movement – The stage of sleep with the highest brain activity, characterized by enhanced brain metabolism and vivid hallucinations, imagery, and dreams. During the REM stage, resting muscle activity is suppressed and there is a high awakening threshold to nonsignificant stimuli.
SpO ₂	Arterial oxygen saturation level via pulse oximetry.

Wi-Fi

Wireless Fidelity; generically refers to any type of 802.11 network. Any devices tested and approved as “Wi-Fi Certified” by the Wi-Fi Alliance are certified as interoperable with each other.

1.7 Contacting Customer Service

If you need product support, call the Respiroics Customer Service department at 1-800-345-6443 (US or Canada only) and 1-724-387-4000.

Additionally, you may contact Respiroics Customer Service at the following email address:

service@respiroics.com

Alice 5 Equipment Setup

This chapter describes how to connect the hardware components included with the Alice 5 system. It contains graphics illustrating the connections as well as detailed step-by-step instructions.

There are several possible ways to set up your Alice 5 system:

- **Wired point-to-point setup**, where wired devices communicate directly with each other (e.g., base station to computer).
- **Wired network setup**, where a switch is used to connect multiple devices to a Local Area Network (LAN).
- **Wireless ad-hoc setup**, a wireless networking framework in which devices communicate directly with each other, without the use of an access point.
- **Wireless Access Point Infrastructure network setup**, where a device acts as a communication hub for users of a wireless device to connect to a wired LAN.

This chapter provides general instructions on how to set up each of these systems. The examples provided are suggested ways of positioning the equipment. You may alter the component setup as needed.

2.1 Before You Begin

Before you set up your Alice 5 system, keep the following information in mind:

- Map out your facility's layout in advance so you know what type of equipment, cables, and accessories you will need.
- Determine whether you will be setting up a wired or wireless network for Alice 5. If you will have a wired network with multiple devices connected, you will need a switch.
- Respironics recommends that you set up the Alice system on its own network, independent of your facility's network(s). System performance may be better on an independent network.
- Your cabling requirements will change depending on whether you use a point-to-point setup or a network setup. You will need a CAT-5 Crossover cable for a point-to-point setup, while a network setup requires a standard CAT-5 Patch cable.
- The Alice 5 system does not support the Dynamic Host Configuration Protocol (DHCP), a protocol for assigning dynamic IP addresses to devices on a network. You **must** assign static IP addresses to your Alice 5 devices and to the computers you are running the Alice Sleepware software on, as well as to any network video cameras or servers you use. See Chapter 3, *Software Installation and Setup*, for additional information.

2.2 Setting Up Your Network

This section describes how to install your system using wired or wireless networks.

2.2.1 Network Setup Examples

This section provides example illustrations of various setups that are commonly used when configuring Alice 5 networks. There are many possible configurations, but these will help you understand some of the basic connections and how the IP addresses are set up. The different wired and wireless setups are described in greater detail in Sections 2.2.2 – 2.2.4.

Note: *It's recommended that you first map your network setup before proceeding with the equipment installation instructions later in this chapter and the software installation described in Chapter 3. You will need to determine what your network configuration is and what equipment you'll be using (if you'll need a switch, a video server, etc.) before you start setting everything up.*

Example 1

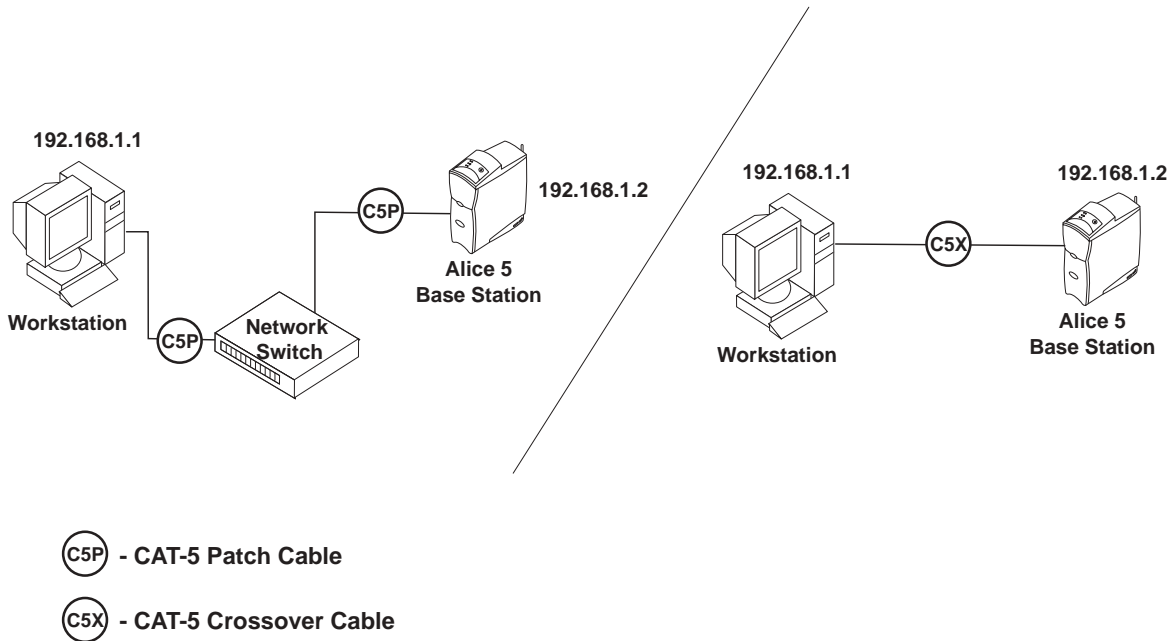

Figure 2–1 Basic Wired Network Setup Using a Switch or a Crossover Cable

Note: The IP addresses shown in Figures 2–1 through 2–4 are only examples. You will need to assign IP addresses that are appropriate for your facility's network.

Example 2

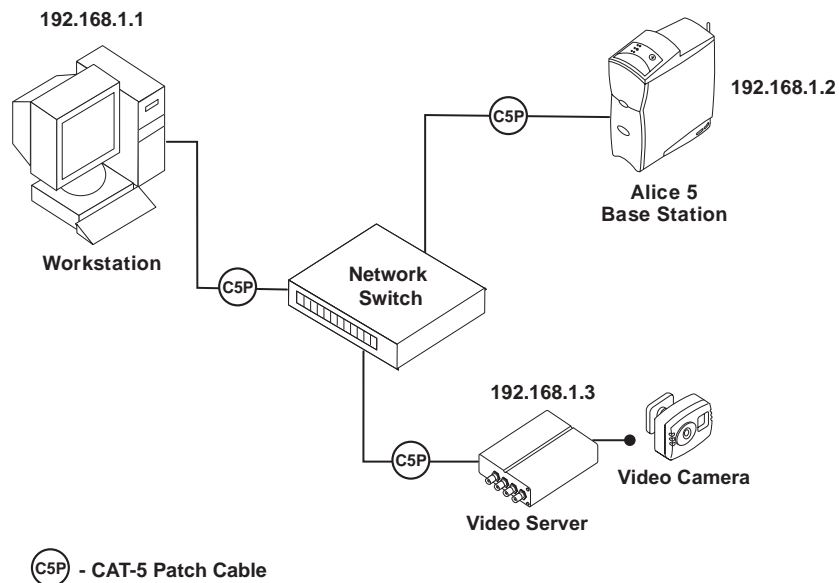

Figure 2–2 Wired Network with Video Server and Camera

Example 3

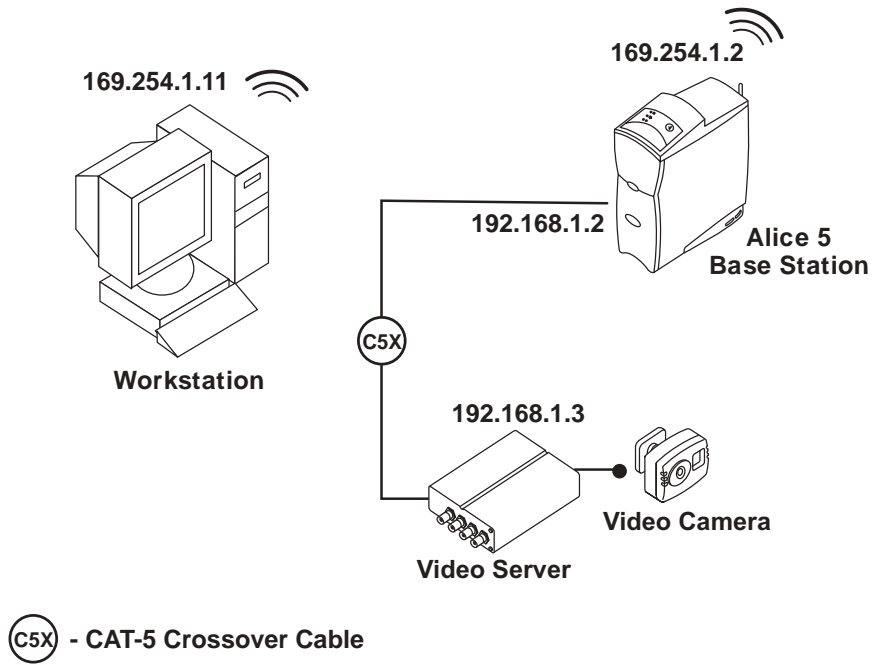

Figure 2–3 Network Setup with Wireless Desktop

Example 4

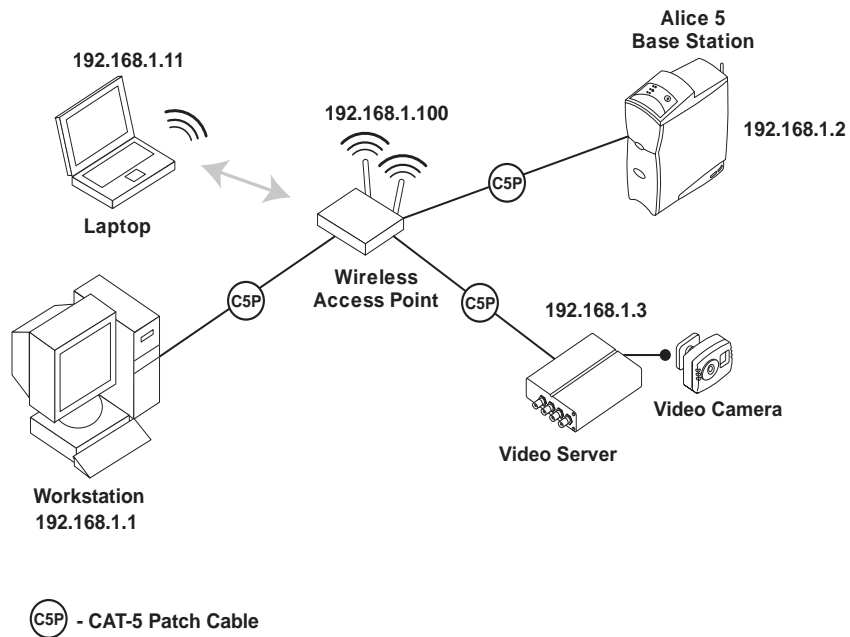

Figure 2–4 Access Point Infrastructure Network Setup

2.2.2 Using a Point-to-Point Setup

If you plan to connect the Alice 5 base station directly to the computer you will be using to view data, you may want to use a point-to-point wired setup or an ad-hoc wireless setup to install the equipment.

Figures 2–5 and 2–6 show point-to-point and ad-hoc setup connections. In Figure 2–5, one desktop computer is directly connected to an Alice 5 device using a CAT-5 crossover ethernet cable.

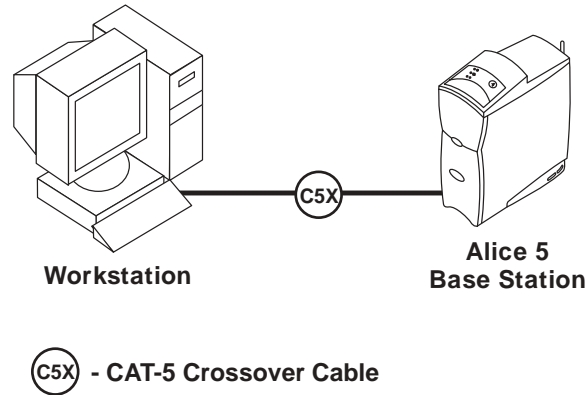

Figure 2–5 Wired Point-to-Point Setup

In Figure 2–6, a laptop is connected to the Alice 5 device wirelessly via an ad-hoc setup.

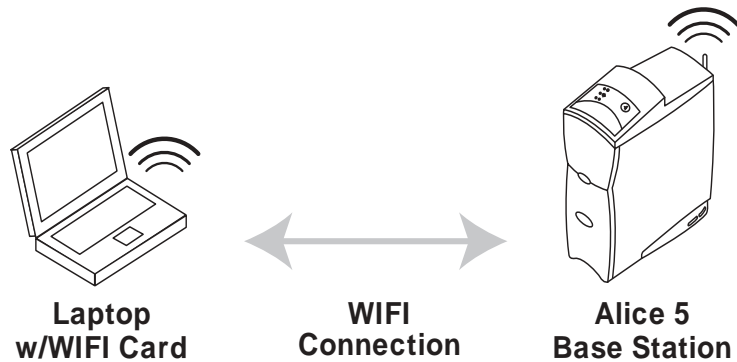

Figure 2–6 Wireless Ad-Hoc Setup

2.2.2.1 Map Your Facility's Network Setup

You can use the space on this page to map out your facility's network configuration and the IP addresses for each piece of equipment.

2.2.3 Using a Wired Network Setup

If you plan to have several patient rooms and several Alice 5 systems or computers, you may want to set your equipment up using a wired network setup. Figure 2–7 provides an example.

Note: Refer to IEC 60601-1-1 for definition of the patient environment.

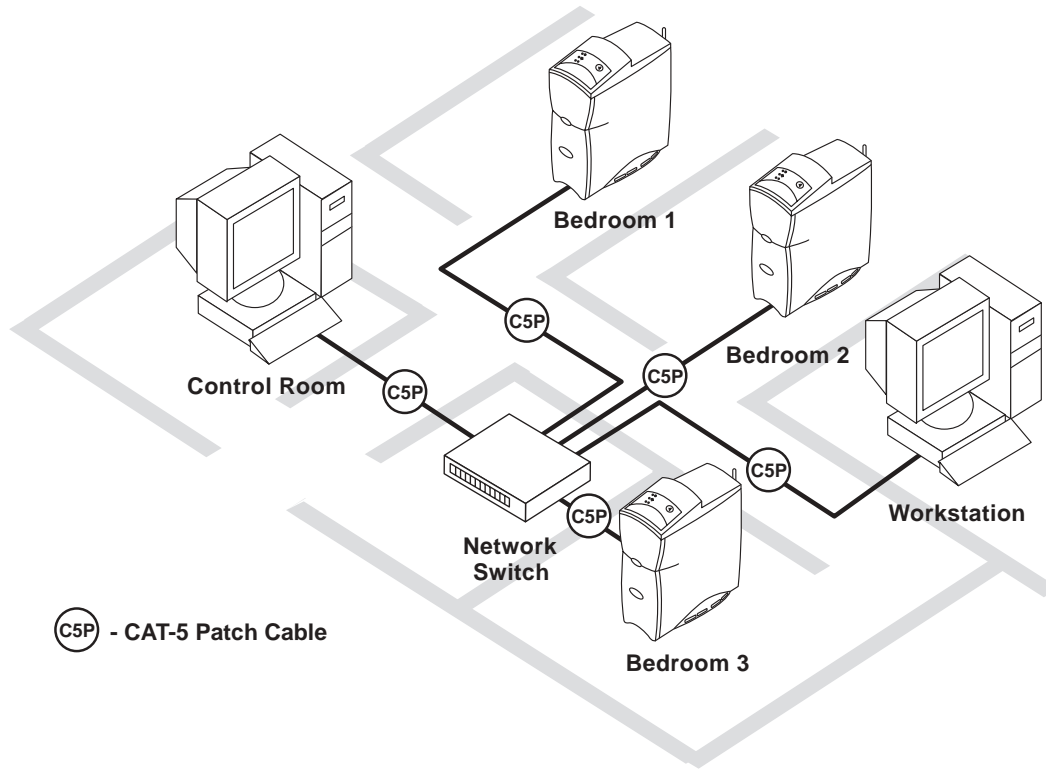

Figure 2–7 Wired Network Setup

2.2.4 Using an Access Point Infrastructure Network

If you plan to have multiple patient rooms with several Alice 5 systems and computers and you want to connect a portion or all of your network wirelessly, you can use an Access Point Infrastructure network. Figures 2–8 and 2–9 show examples of possible setups.

Figure 2–8 shows a network in which multiple computers are connected to multiple Alice 5 devices through a wireless access point.

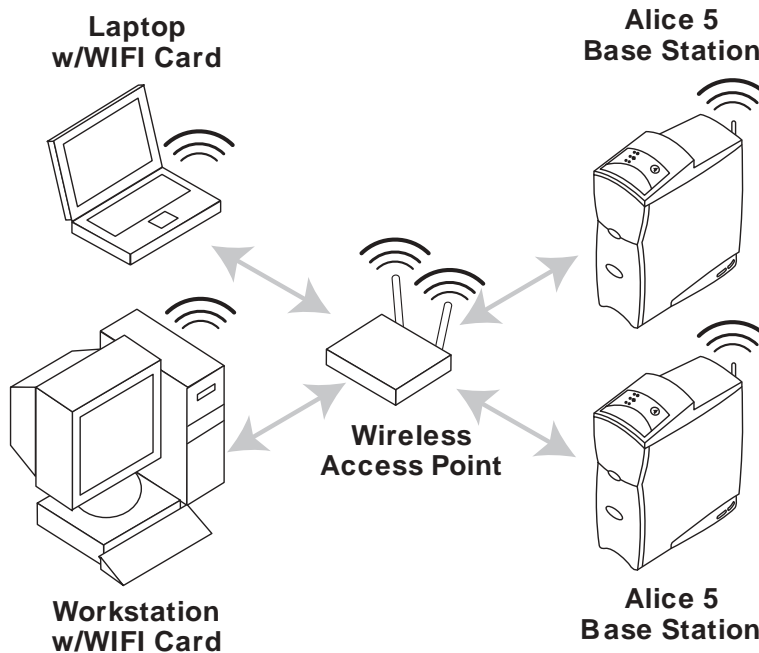

Figure 2–8 Access Point Infrastructure Network Setup – Example 1

Figure 2–9 shows a network in which multiple computers are connected to an Access Point wirelessly, but the Alice 5 devices are connected to the network switch using ethernet cables, and the switch is connected to the Access Point using an ethernet cable.

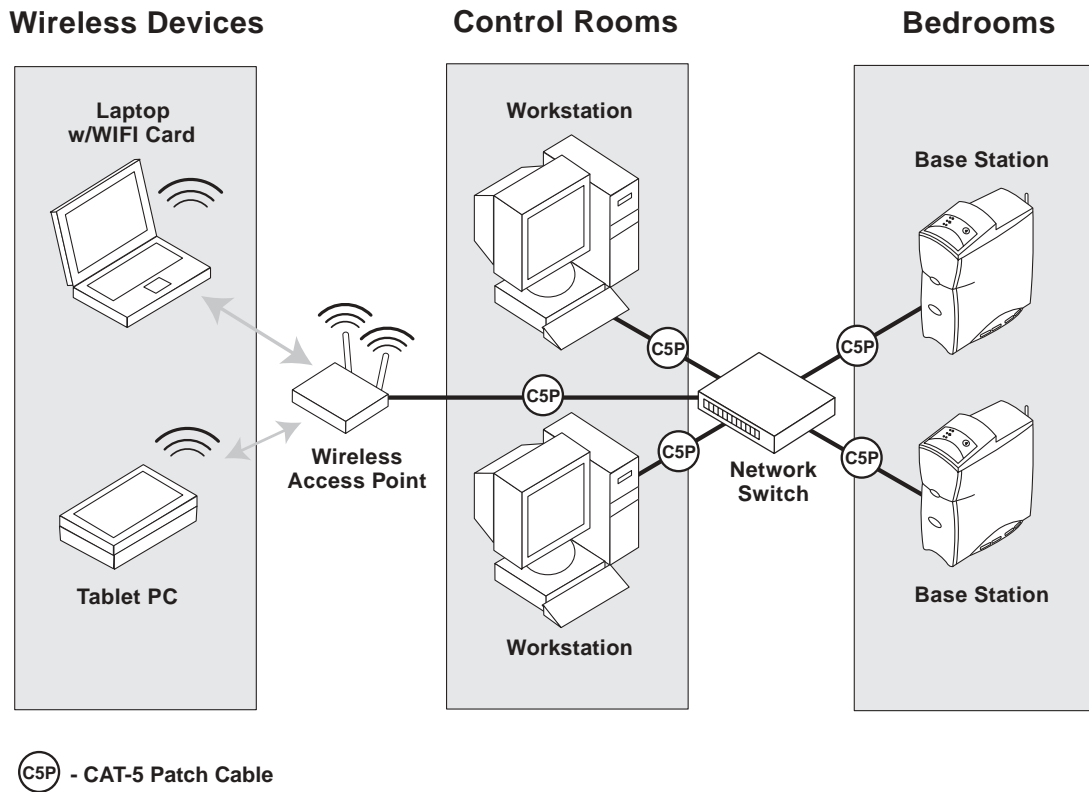

Figure 2–9 Access Point Infrastructure Network Setup – Example 2

2.2.5 Connecting the Alice 5 Hardware Components

Once you have determined which type of setup you will be using (point-to-point, ad-hoc, wired network, or access point infrastructure network), you can connect your Alice 5 equipment.

Figure 2–10 provides a detailed illustration of how different devices and cables are connected to the back panel of the base station. The steps that follow refer to many of the connectors shown in Figure 2–10.

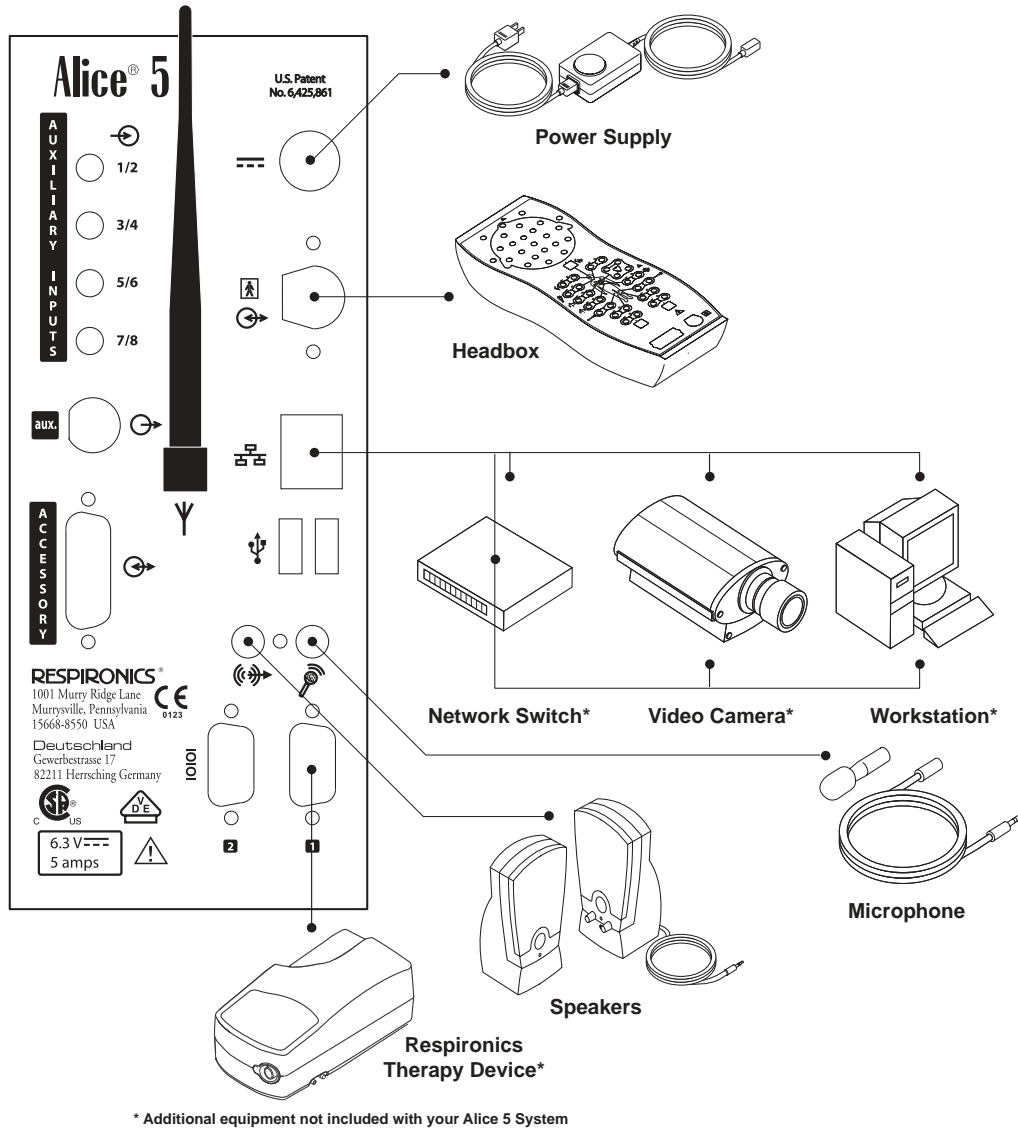





Figure 2–10 Base Station Back Panel

Complete the following steps to set up your Alice 5 hardware. Refer to Figure 2–12 for a detailed example of how the final room setup might look.

1. If you haven't already done so, unpack your computer and set it up according to the instructions supplied with it.
2. Unpack your Alice 5 system and make sure that all of the components are included.
3. Make sure that the base station is placed on a flat, stable surface close enough to allow for easy connection to the headbox. The base station should also be placed within easy access to an external AC power supply that is properly grounded.
4. Place the headbox on a table or stand above and behind the patient's head, beside the patient's pillow, or on a nearby hook using the carrying strap supplied with your system. Or, use the mounting bracket to mount the headbox on a wall.
5. Connect the power cord to the AC power supply.
6. Plug the pronged end of the power cord into a wall outlet.

Caution: *Never use an extension cord with the Alice 5 system. Always operate the device using a properly grounded AC power outlet. If you are unsure whether a power outlet is properly grounded, contact an electrician for assistance.*

7. Connect the power supply's cord into the Power Connector port () on the back of the base station.
8. Plug one end of the Patient Cable into the headbox connector port () on the back of the base station.
9. Plug the remaining end of the Patient Cable into the Serial Connection () on the headbox (as shown in Figure 2–11).

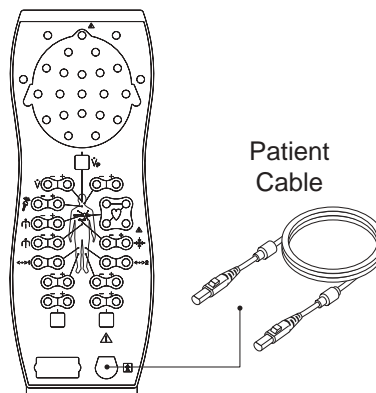



Figure 2–11 Patient Cable Connection

Note: *The ends of the Patient Cable are interchangeable. It does not matter which end you plug into the base station and which end you plug into the headbox.*

10. Follow Step A for point-to-point wired setups, Step B for wired network setups, or Step C for ad-hoc or access point infrastructure setups.

A. For Point-to-Point Wired Setups:

- Plug a CAT-5 crossover cable into the Network port () on the back of the base station.
- Then, plug the remaining end of the cable to your computer's network interface connector.

B. For Wired Network Setups:

- Plug a standard CAT-5 Patch cable into the Network port () on the back of the base station.
- Then, plug the remaining end of the cable into an ethernet connection. For example, if you have set up your network switch in your control room, you can run the CAT-5 Patch cables from the base stations in each patient room to the ethernet connectors on the switch, so that all base stations are plugged into the same network.
- To connect your computer to the network, plug a CAT-5 Patch cable into your computer's network interface connector, and plug the other end of the cable into an ethernet connection (e.g., a connector on a switch).

C. For Wireless Ad-hoc or Access Point Infrastructure Setups:

- Plug a standard CAT-5 Patch cable into the Network port () on the back of the base station.
- Then, plug the remaining end of the cable into an ethernet connection.

Note: *In Step C, although you are configuring a wireless setup, you still need to perform this step when initially setting up your Alice 5 system. For network security reasons, the wireless feature is disabled when you first receive your Alice 5 device. **In order to enable the wireless feature, you must first set up the device as a wired connection to allow your device to be seen on the network.** Then, after you enable the wireless feature via the Sleepware software, remove the ethernet cable. Once the wireless feature is enabled, the system uses the wireless antenna attached to the Antenna connector () on the back of the base station to transmit data.*

11. If you are using a microphone for intercom/ambient sound recording, plug the male end of the Microphone cable into the Microphone connector () on the back of the base station. Plug the remaining end of the Microphone cable into the microphone you are using on the patient.

Note: Once you install Sleepware and add your Alice devices (as described in Chapter 3), you can enable the audio feature by right-clicking on the Room button located on the Starter bar and selecting **Audio/Video Settings** from the drop-down menu. See Section 2.4, *Adding Accessories*, for instructions on setting the audio and video settings.

12. If you are using speakers with your system, connect the green, male end of the Speaker cable into the Speaker Connector () on the back of the base station. Connect the other end of the cable directly into any basic-powered PC computer speaker.

Note: If the technician is in a control room separate from the sleep lab, the speakers and microphone allow the technician to speak directly with the patient from the control room. The speakers and microphone work in the same one-way format as an intercom.

Once you've installed the speakers, if you want to change the volume, you can adjust the volume control on the speakers or you can use the volume control setting on your computer.

13. To connect a Respironics therapy device (CPAP, Bi-Level, etc.) to the Alice 5 system, connect the serial connector end of the therapy device's Communications Cable into the Com 1 Serial Connection port () on the back of the base station. Connect the remaining end of the Communications Cable to the port on the back of the therapy device or to the Sleeplink card, if applicable. This allows you to control the therapy device directly through the Alice 5 system. Refer to the therapy device's manual for connection information.
14. If desired, you can connect additional external medical devices, produced by other manufacturers, using the Auxiliary Input connectors on the back of the base station. Refer to these devices' manuals for additional information.

Note: All other connectors on the base station (USB ports, Accessory ports, the Auxiliary channel, and the Com 2 Serial Connection port) are not currently used.

15. Install the Alice Sleepware software using the instructions found in Chapter 3.

Figures 2–12 and 2–13 provide a more detailed example of how a network setup may look.

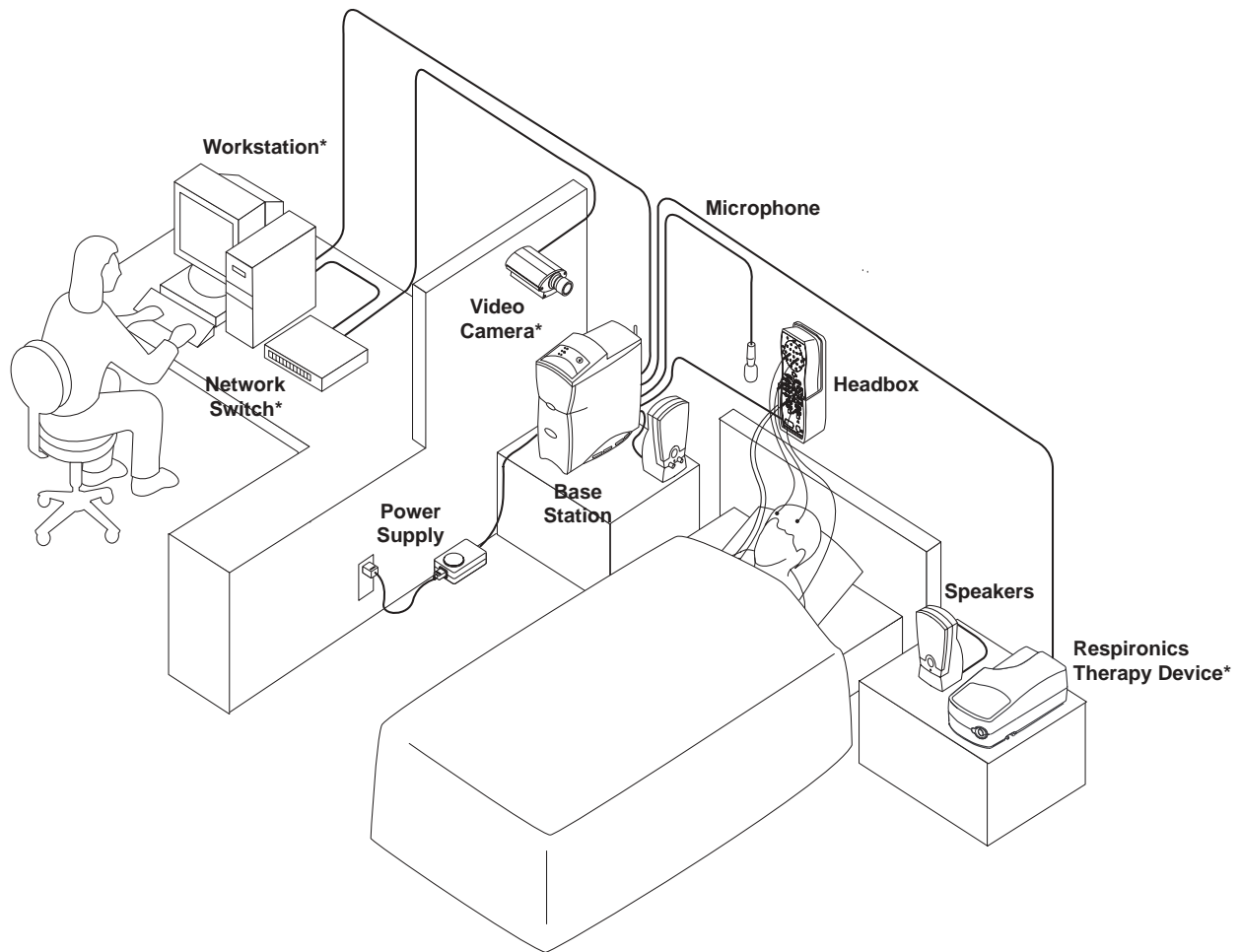

* Additional equipment not included with your Alice 5 System

Figure 2–12 Detailed Wired Network Setup – Single Bedroom

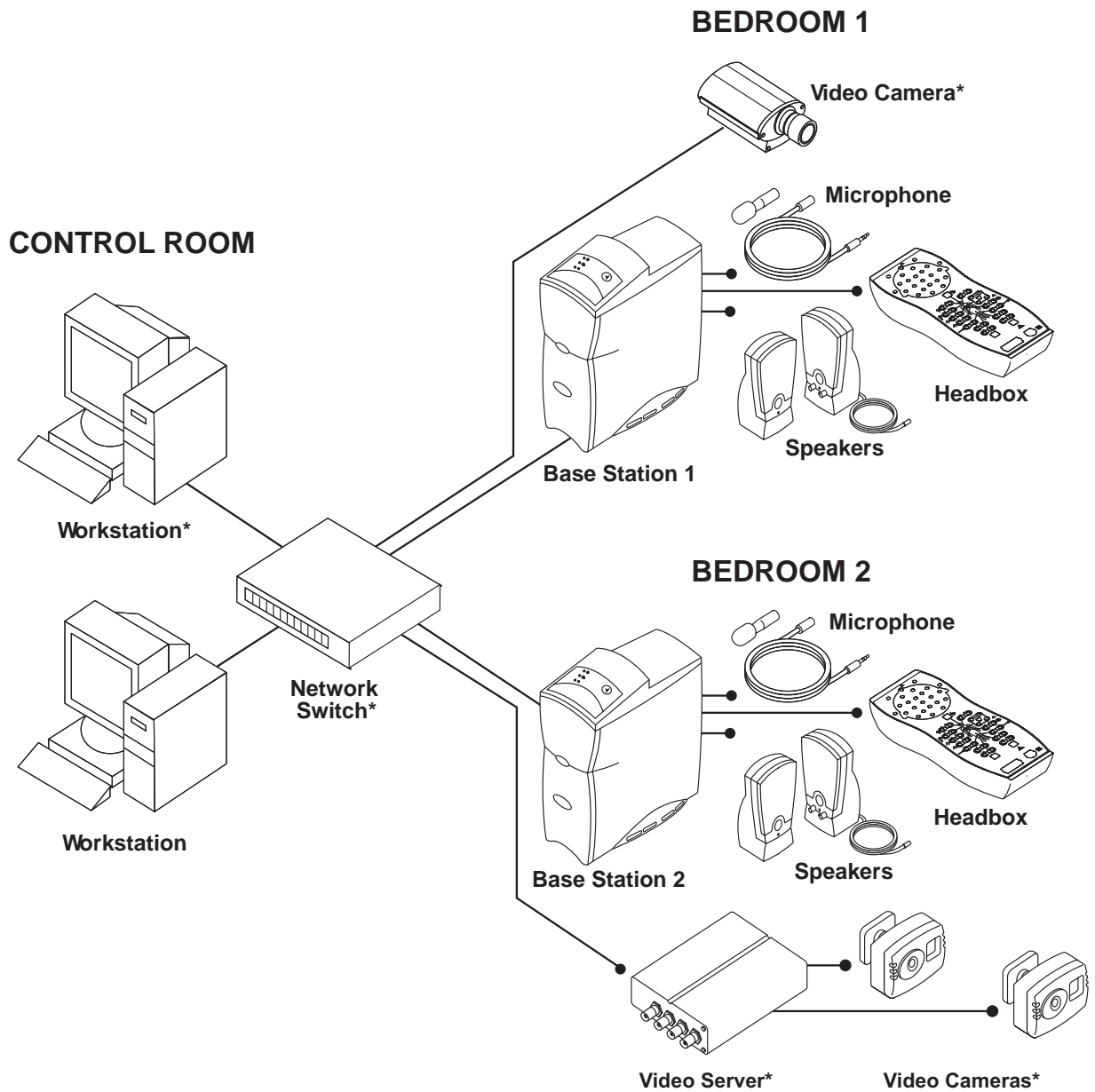

* Additional equipment not included with your Alice 5 system.

Figure 2–13 Detailed Wired Network Setup – Multiple Bedrooms

2.3 Integrating Alice 3 and Alice 4 Devices into your Alice 5 Network

You can connect Alice 3 and Alice 4 devices to your network and use them in combination with Alice 5 devices and Alice Sleepware.

Figure 2–14 illustrates how these devices might be incorporated into your network.

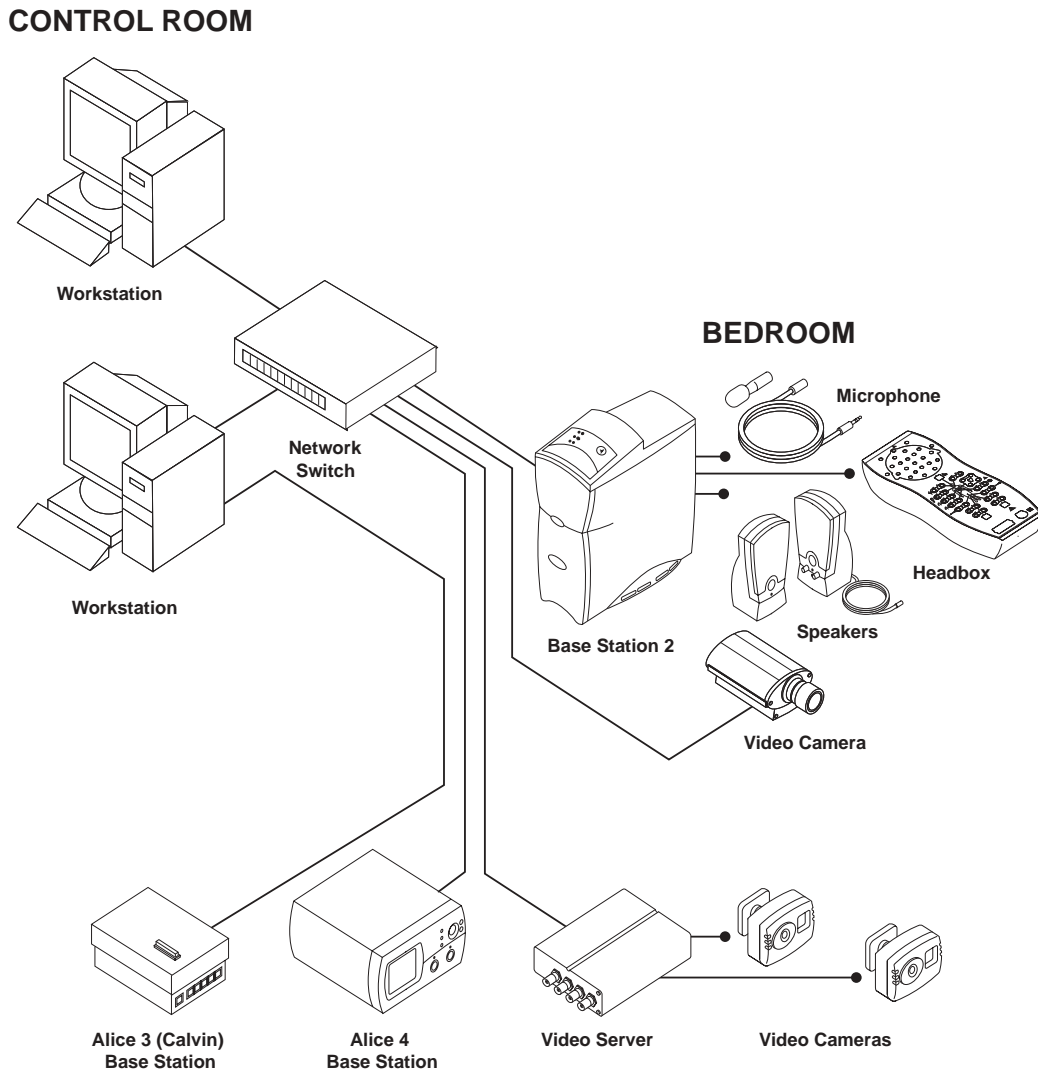

Figure 2–14 Sample Network Containing Alice 3 and Alice 4 Devices

2.4 Adding Accessories

There are many additional accessories you can use with the Alice 5 system. See the *Respironics Diagnostic Accessory Guide* for details on the many accessories available.

This section provides instructions on how to set up video cameras and video servers with the Alice 5.

2.4.1 Installing Video Cameras and/or Video Servers

You may want to install video cameras and/or video servers to use with your Alice system. There are a few setup options when using video cameras with the Alice 5 system:

- Connect a video camera directly to the base station if your Alice 5 equipment is communicating with your computer through a wireless interface.
- Connect a video camera to a switch on your network.
- Connect multiple video cameras (up to four) to a video server that is connected to your network's switch or hub. You must be using a network switch with your Alice 5 system to use a video server.

Note: *If your computer is wired to the base station, or if you are using a network switch that is wired to the base station, you **cannot** connect a camera directly to the Alice 5 device.*

Note: *See the Respironics Diagnostic Accessory Guide to determine what video server is compatible with the Alice 5 System and to order video cameras if needed. Refer to the instructions included with your video server for more detailed product information.*

Decide which option you want to use, and then follow the installation instructions below.

1. Connect your video equipment to the Alice 5 system using one of the following three configurations:
 - a. **If you are connecting a video camera directly to the base station**, connect a CAT-5 crossover cable to the network connector on the video camera, and connect the other end of the cable to the Network port () on the back of the base station.
 - b. **If you are connecting a video camera to your network switch**, connect a CAT-5 patch cable to the network connector on the video camera, and connect the other end of the cable to one of the ports on your switch.
 - c. **If you are connecting one or more video cameras to a video server:**
 - Connect a CAT-5 patch cable to the network connector on the rear panel on the video server, and then connect the other end of the cable to an ethernet connection on your switch.

- If your camera has a BNC connector on it, connect a coaxial video cable to one of the video inputs (BNC connectors) on the front panel of the video server, and connect the other end of the cable to the BNC connector on the camera. Repeat this step if you are adding more than one camera.

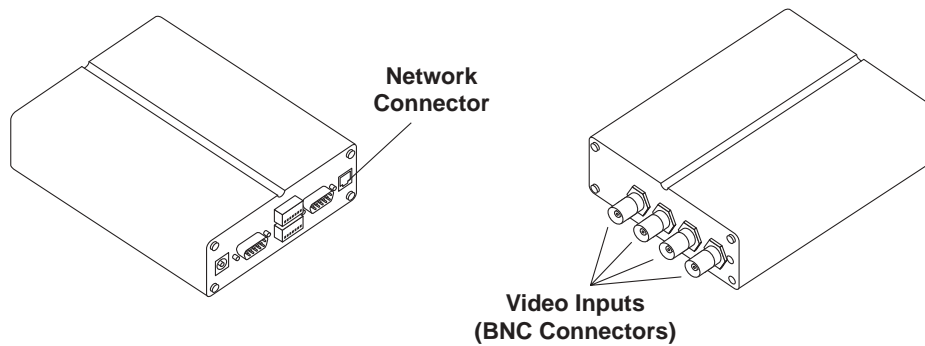

Figure 2–15 Video Server Front and Rear Panel Connections

Note: *If your camera does not have a BNC connector and has a standard phono-type RCA connector instead, you will need a BNC-to-RCA converter to connect the camera to the video server.*

2. Note the serial number on your video camera or on the bottom of the video server if you are using the server. You need to know this to set the IP address.

Note: *If you are using a video server, you only need to assign the server an IP address, not the cameras. However, if you are connecting a camera directly to the base station or to a switch, assign an IP address to the camera.*

Note: *The serial number on the video equipment is the same as the MAC/Ethernet address you will enter in step 3 below (e.g., 00408c100086 = 00-40-8c-10-00-86).*

3. From a computer on your network, assign the video camera or video server (depending on your setup) a unique IP address:
 - From your Windows operating system, start a DOS window by going to Start>Run and typing `cmd` in the text box that appears. Click **OK** to access DOS.
 - Type the following command in the window that appears:

Syntax:

```
arp -s <Video Camera or Server IP address> <MAC/Ethernet address>
```

For example:

```
arp -s 172.21.1.200 00-40-8c-10-00-86
```

- Press **Enter**, and on the next line, type the following command:

Syntax:

```
ping -t <Video Camera or Server IP address>
```

For example:

```
ping -t 172.21.1.200
```

4. You will now see “Request timed out” messages repeatedly appearing in the window.

Note: *If the “Request Timed Out” messages do not appear, and the message “Destination Host Unreachable” appears instead, then the video equipment is not accessible on your subnet. Refer to Chapter 7, Troubleshooting, for information on how to resolve this problem.*

5. Connect the power supply to the video camera or server.

Note: *If you connected the power supply before entering the DOS commands, unplug it and reconnect it at this time.*

6. Approximately 25 seconds after connecting the power supply, the message “Reply from <Video Camera or Server IP address>” appears. If using the video server, make sure the power indicator on the front panel of the server is permanently lit and that the network indicator flashes intermittently.

Note: *If you do not receive the “Reply from...” message, refer to Chapter 7, Troubleshooting, for information on how to correct the problem.*

7. Exit ping. The installation is complete, and you are ready to access the video camera(s) from your browser.

Note: *The remaining steps in this section explain how to enable video through Alice Sleepware once you have installed the software. For instructions on software installation, see Chapter 3.*

- To enable the video feature through Alice Sleepware, go to your Starter Bar, right-click on the Room button, and select **Audio/Video Settings** from the drop-down menu, as shown in Figure 2–16.

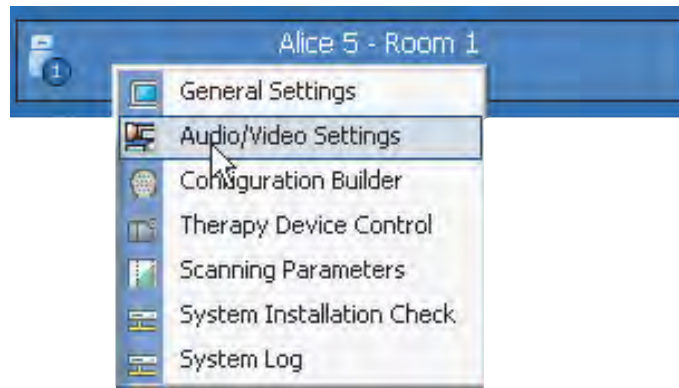

Figure 2–16 Accessing the Audio/Video Settings

- Choose your multimedia and image settings in the screen shown in Figure 2–17.
- In the Camera/Server settings, type in the IP address of the video camera or video server and the port number that the video camera is connected to (Port # 1-4 if using the video server).

Note: *The Camera/Server Port number will always be 80.*

Note: *See the Alice Sleepware User's Guide for more information on these settings and for details on how to view and save video, etc.*



Figure 2–17 Audio/Video Settings Screen

Note: After you have enabled the settings, the **Audio/Video** icon () will appear on your Room button, and you can right-click on it to access the screen shown in Figure 2–17 if you want to modify your audio/video settings.

The video will appear on your screen.

Note: If the video does not appear after you have completed all of the steps above, refer to Chapter 7, *Troubleshooting*, for information on how to resolve the problem.

Software Installation and Setup

Once you have installed your Alice 5 equipment, you will need to install the Alice Sleepware software on your computer(s). This chapter describes how to install the software and how to add a device so your computer can communicate with your Alice system. When adding a device, you can specify whether you are connecting through a wired or wireless interface.

Before installation, please note the following:

1. You must be logged onto the computer as “administrator” to install the software.
2. If one or more restricted users will be running Alice Sleepware, the permissions on the installation directory must be opened so that everyone has both read and write access to all applicable files.

Note: *When you change access permissions on a folder, Windows will prompt you with a choice between applying changes to “this folder only” or to “this folder, subfolders, and files.” Choose the second option to apply changes to all of the folders/files.*

3. If acquisition data will be shared by multiple restricted users, or if the user recording the data and the user scoring the data are two different restricted users, then the permissions on all data locations must be opened so everyone has read and write access.

After installation is complete, if multiple restricted users will be using the software, you will also need to complete the following steps:

4. Create all of the data locations needed (see the *Alice Sleepware User’s Guide*).
5. As administrator, change the security rights attached to the following folders: c:\alice5 (or the directory where the software has been installed), c:\al5_data, (and c:\al4_data or c:\al3_data if you have acquisition data in those locations) and any other data locations you’ve created, to allow all users full control of these directories.

Note: *After installation is complete, you can change the user type back to “restricted” on the computer if necessary.*

3.1 Alice Sleepware Software Installation

Complete the following steps to install the Alice Sleepware software.

Note: *It is recommended that you close all other software programs before installing the Alice Sleepware software.*

1. Insert the Sleepware CD into your computer's CD drive.
2. In the first screen, shown in Figure 3–1, select **Install Software**.

Note: *The version numbers shown on the screens in this manual are for example only. Your software version may differ from the one shown here.*

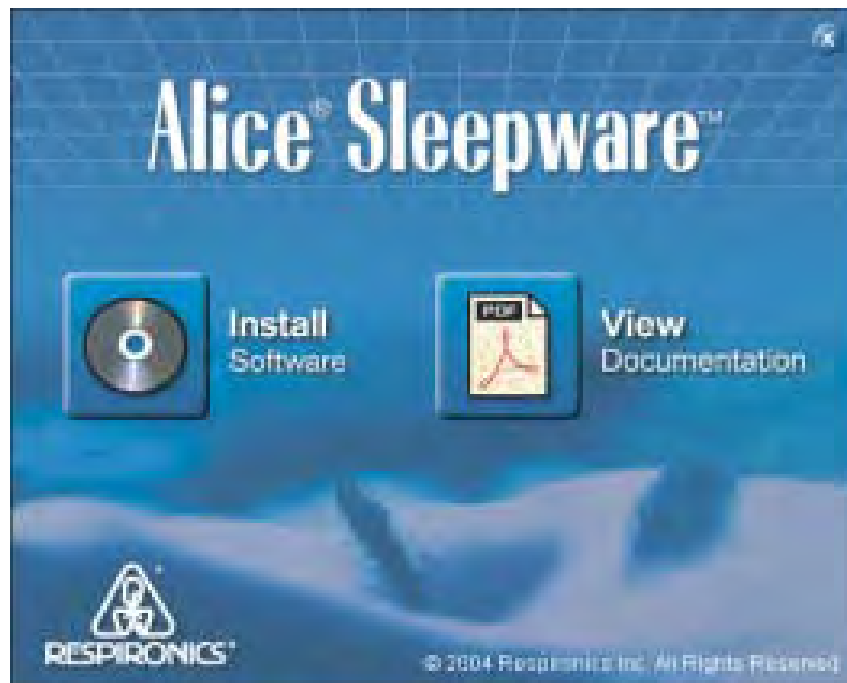

Figure 3–1 Alice Sleepware Start-Up Screen

The Installation Wizard automatically launches.

Note: *You can also select **View Documentation** on this screen to access a list of available Alice Sleepware and Alice 5 manuals. These manuals are available in PDF format on the CD. You must have Adobe® Acrobat® Reader to view the manuals.*

3. In the next screen, select one or both of the following items if they apply to you, as shown in Figure 3–2.
 - **Alice Sleepware (required)** – This item must be selected (it is automatically checked).
 - **Auto-launch Alice Starter** – Check this box if you want the Alice Starter to automatically launch upon logging in. If you do not check this box, you will have to manually open the Starter bar by either double-clicking the Alice Starter icon on your desktop, or right-clicking on the **A** icon in the lower right corner of your screen and then selecting **Launch Alice Starter** from the menu options.

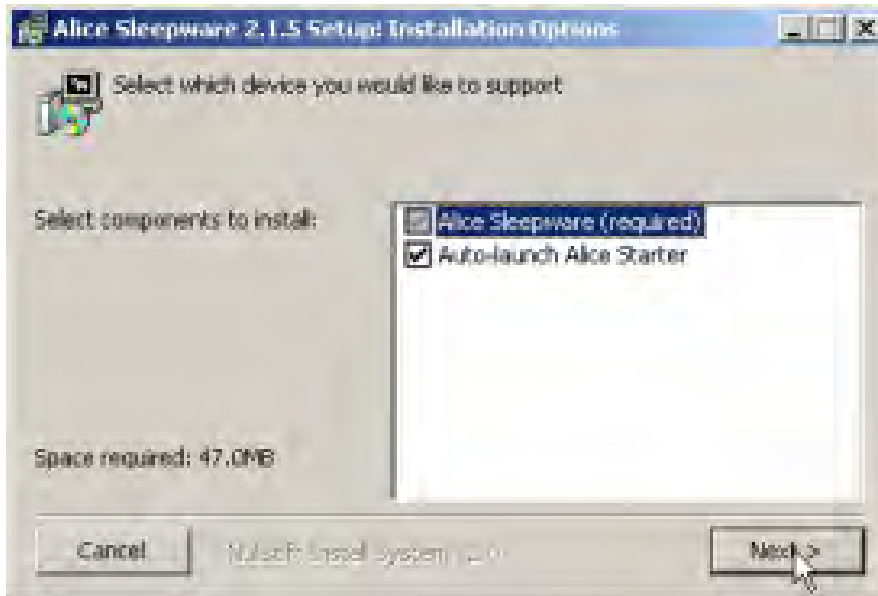

Figure 3–2 Software Installation Startup Screen

4. Click the **Next** button.

- Specify the directory where you want the software program to be installed (or use the default directory shown), and click **Install**, as shown in Figure 3–3.

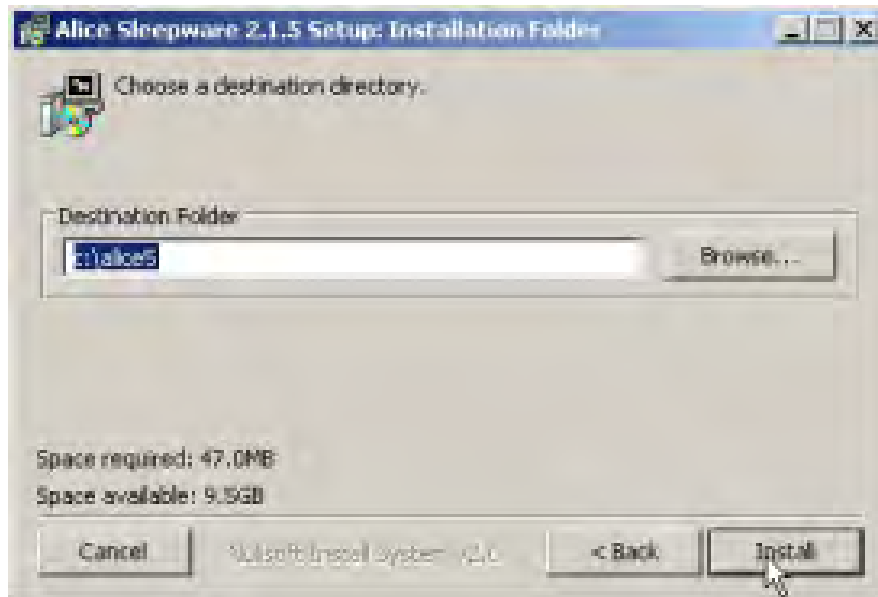

Figure 3–3 Installation Directory Screen

A progress bar appears, indicating that the installation is in process, as shown in Figure 3–4.

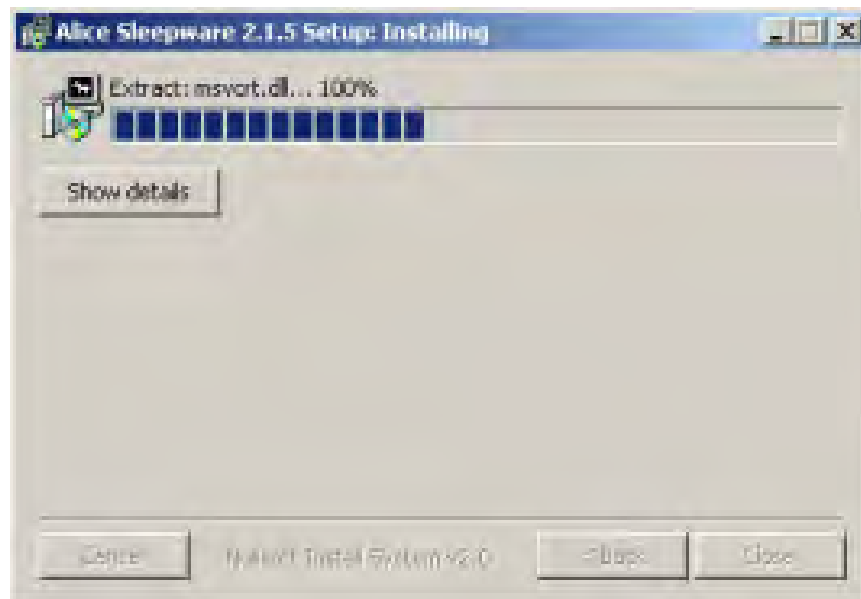

Figure 3–4 Installation Progress Screen

After the installation is complete, the following software shortcut icons are automatically placed on your desktop for easy access to the software:



Figure 3–5 Sleepware Shortcut Icons

Additionally, if you selected the option to automatically launch the Alice Starter, the Alice Sleepware starter bar appears at the top of your screen, as shown in Figure 3–6. The Starter bar is a toolbar that you can use during equipment setup for configuration and during data acquisitions to view settings or control the optional microphone and camera.



Figure 3–6 Alice Sleepware Starter Bar

Note: *If the Alice Sleepware software did not install properly, refer to Chapter 7, Troubleshooting for help resolving this problem.*

3.2 Adding Alice Devices

Through the Alice Sleepware software, you can add Alice 3, 4, or 5 devices. This section describes how to add Alice 5 devices. For instructions on how to add an Alice 3 or 4 device, refer to the *Alice Sleepware User's Guide*.

3.2.1 Adding an Alice 5 Device

Note: *The Alice 5 system does not support the Dynamic Host Configuration Protocol (DHCP), a protocol for assigning dynamic IP addresses to devices on a network. You must assign a static IP address to your Alice 5 device.*

To add an Alice 5 device, complete the following steps:

1. Left-click on the **Configure** button on the Alice Sleepware starter bar, and select **Add/Modify Device** as shown in Figure 3–7.



Figure 3–7 Add/Modify Device

2. The Add/Modify Device menu appears, as shown in Figure 3–8. Select **Alice 5**.



Figure 3–8 Add/Modify Device Menu

3. A list of Alice 5 devices that are configured to communicate with your computer appears. If there are no Alice devices currently configured, the list will be empty, as shown in Figure 3–9.



Figure 3–9 List of Configured Alice Devices

Click **Add** to configure an Alice 5 device.

4. The Alice 5 Configuration Wizard appears as shown in Figure 3–10. Click **Next**.



Figure 3–10 Alice 5 Configuration Wizard – Main Screen

5. The Preparing Your PC screen appears, as shown in Figure 3–11.

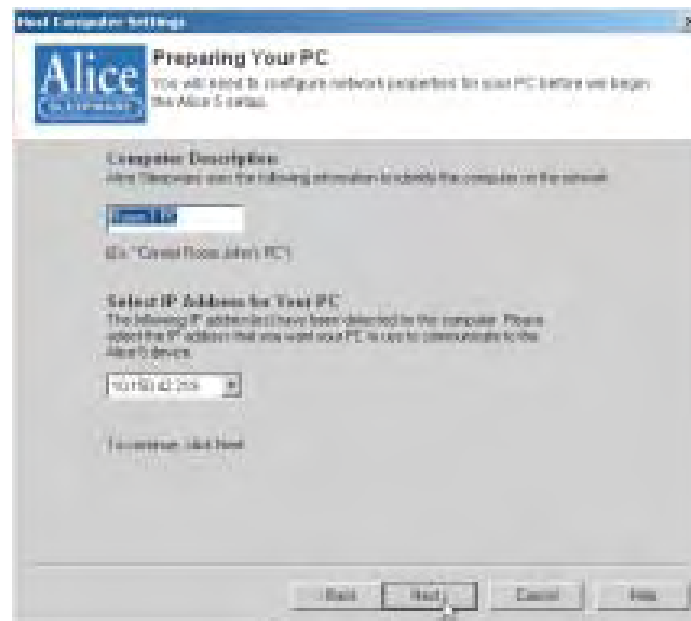

Figure 3–11 Preparing Your PC Screen

Note: If you set up a device on your network with a specific IP address and then later change the IP address of that same device, you must return to the Add/Modify screens and reconfigure the device using its new IP address; otherwise, the device will no longer be found on the network.

If you want to update your settings, click the **Edit** buttons to the right of the fields and do the following:

- In the **Computer Description** field, type in a name for your computer so the Alice Sleepware software can identify your computer on the network. You should choose a name that will help you easily identify the computer on the network when you are trying to set up Alice devices to communicate with that particular computer.
- The **Select IP Address for Your PC** field will already be filled in if the software has detected an IP address for your computer. If several IP addresses are included, choose the address that you want your computer to use to communicate with the Alice 5 device.

If more than one address appears and you are not sure which address is correct, complete the steps below to find your computer's IP address:

- a. On your computer, go to Start > Control Panel and double-click on **Network Connections**.

Note: If you are using Windows 2000 or the Windows Classic theme in Windows XP, you will need to go to Start>Settings>Control Panel in the above step.

- b. Double-click on **Local Area Connection** (or **Wireless Network Connection** if you are on a wireless network) to access the following screen:

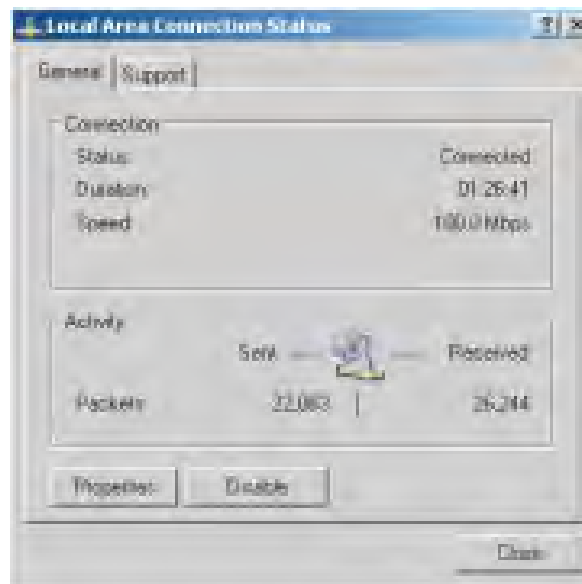

Figure 3–12 Local Area Connection Status Screen

- c. Select the **Support** tab to view your computer's IP address, as shown in Figure 3–13.



Figure 3–13 Local Area Connection Status – Support Tab

- d. Click **Close** and then select this address in the **Select IP Address for Your PC** field on the Preparing Your PC screen. Click **Next**.

6. The Alice 5 Connection Mode screen appears, as shown in Figure 3–14. Specify whether your Alice 5 device is connected through its wired or wireless interface, and then click **Next**.

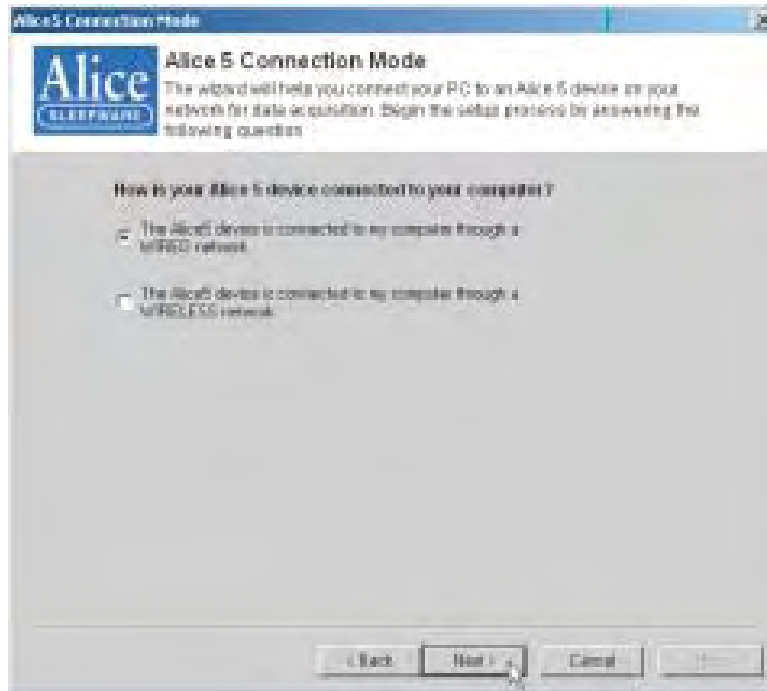

Figure 3–14 Alice 5 Connection Mode Screen

Attention! *On this screen, you are specifying the type of connection **from the base station to the network**, not the connection from the computer to the network.*

To help determine if your network is wired or wireless, consider the following:

- If your base station is wirelessly connected to the access point, is your access point connected to the network switch via an ethernet cable? If so, you must choose the **wired** network option. Even though your base station is connected to the access point wirelessly, the access point is then connected to the rest of the network via a wired connection.
- If all of the devices in your network are wirelessly connected to the access point, choose the **wireless** network option (see Figure 2–8 for an example illustrating this setup).

Note: *If you are still not sure whether your network is wired or wireless, contact your network administrator.*

Note: Refer to Chapter 2 for additional information on wired and wireless network setups.

The Select an Alice 5 device screen appears, as shown in Figure 3–15.



Figure 3–15 Search for Alice 5 devices Screen

7. Select the Alice 5 device that you want to add. The list shows all devices that are available. Highlight the device and click **Next** to continue the installation process.

Note: If you are installing a new device or are not sure which device to choose from the list, find the serial number on the back panel of your Alice 5 base station, and then choose the device in the list that has that same serial number.

What if My Device Isn't Listed?

If you cannot find your Alice 5 device in the list provided in Figure 3–15, you will need to place a check mark by the statement “I did not find the device I want to add, the serial number is not listed in the above list,” and click **Next**.

The screen shown in Figure 3–16 appears if you are connecting the Alice 5 device through a wired interface.



Figure 3–16 Alice 5 Device Network Settings Screen – Wired

- Type in a unique name for the Alice 5 base station in the first field. This name will help you identify the base station on the network.
- In the TCP/IP Address field, type in the unique IP address of the Alice 5 base station you are adding.
- Click **Next** and go to Step 9.

If you are connecting the Alice 5 device through a wireless interface, when you place a check mark by the statement “I did not find the device I want to add, the serial number is not listed in the above list,” in Figure 3–15 and click **Next**, the screen shown in Figure 3–17 appears.



Figure 3–17 Alice 5 Device Network Settings Screen – Wireless

- Type in a unique name for the Alice 5 base station in the first field. This name will help you identify the base station on the network.
- Check the **Enable Wireless Interface** box to enable wireless. The wireless setting is disabled by default when the base station is shipped, so you **must** check this box in order to configure the base station’s wireless interface.
- Select **Ad-Hoc** if you are using a direct, peer-to-peer network, or select **Infrastructure (Via an Access Point)** if your network is connected via a wireless access point.
- In the Wireless General Settings, type in the Service Set Identifier (SSID). This is the unique name shared among all points in a wireless network. The SSID is required if your Alice 5 base station is connected through a wireless interface. It is case sensitive and must not exceed 32 characters. Make sure this setting is the same for all points in your wireless network.

- If you selected **Ad-Hoc** for the wireless network mode, you will need to select the **Channel** you are using in the Wireless General Settings. All devices on the network must share the same channel in order to function correctly. There are 11 possible channels that you can choose from. Similar to channels on a telephone, you can choose a channel that does not have much traffic on it to ensure that the wireless connection speed is as fast as possible. Enter any number from 1-11. If you are not sure what channel to choose, contact your network administrator.

Note: If you select **Infrastructure** for the wireless network mode, you will not need to select a channel. The **Channel** field will be grayed out.

- In the **TCP/IP Address** field, type in the unique IP address of the Alice 5 base station you are adding.
- Select the desired Wireless Encryption setting. You can choose from three levels of encryption: **Off** (no encryption), **On (64 bits)**, or **On (128 bits)**.
Off means that there is no security for the data being transferred on the wireless network between the base station and the computer.
On (64-bit) encryption allows you to enter a 10-character key in the **Key** field. The longer or more complicated the key, the more security the encryption may achieve.
On (128-bit) encryption allows you to enter a 26-character key in the **Key** field, which provides even greater network security.
- If you've enabled encryption, type in the appropriate key (10 characters for 64-bit encryption or 26 characters for 128-bit encryption). The key can consist of any number ranging from 0 to 9 and/or any letter ranging from A to F.
- Click **Next** and go to **Step 9**.

8. If your device appeared in the list of devices on the screen shown in Figure 3–15, after you highlight the device you want to add and click **Next**, the screen shown in Figure 3–18 appears. This screen will be different depending on whether you specified that you have a wired or wireless network on the screen shown in Figure 3–14. If you specified that the Alice 5 is connected through a *wired* interface, the screen shown in Figure 3–18 appears. If you specified that the Alice 5 is connected through a *wireless* interface, the screen shown in Figure 3–19 appears. Follow the instructions for the screen that applies to you.

The screen in Figure 3–18 appears when you are configuring the Alice 5 device’s wired interface.



Figure 3–18 Alice 5 Device Wired Network Settings

- In the first field, type in a unique name for the Alice 5 base station. This name will help you identify the base station on the network.

- In the Alice 5 Network Settings fields, type in the TCP/IP address, subnet mask, and gateway information for the Alice 5 device so your computer will be able to fully communicate with the device on the network.
 - a. In the TCP/IP Address field, type in the unique TCP/IP address for your Alice 5 device. The Alice 5 device, like your computer, needs to be connected to your lab or hospital's computer network in order to exchange data with the computers on that network.

Note: *If you set up your Alice 5 network on its own subnet, you may not need to change the device's IP address to a unique address. Each Alice 5 device has its own unique wired and wireless IP address based on the serial number on the device, so changing the device's IP address will not be necessary if you use this type of configuration.*

Note: *If you do not know the TCP/IP address for your Alice 5 device, contact your network administrator.*

- b. Type in the correct Subnet Mask for your Alice 5 device. A subnet mask is like a filter that is applied to a message's destination IP address. Its objective is to determine whether the local network is the destination network. On TCP/IP networks, subnets consist of all devices whose IP addresses have the same prefix.

Note: *If you do not know what subnet you are on, contact your network administrator.*

- c. If your Alice 5 device is not on the same subnet as your computer, you need to enter the correct Gateway address in the **Gateway** field. Enter the IP address of your network's Gateway (such as a router), which is used to allow for contact between multiple networks. If your network does not have a Gateway, then leave this field blank.

Note: *If you do not know the correct Gateway address, contact your network administrator.*

The screen in Figure 3–19 appears if you are configuring the Alice 5 device’s wireless interface.



Figure 3–19 Alice 5 Device Wireless Network Settings

- In the first field, type in a customized name for your Alice 5 device so you and your colleagues can easily identify the device on your network in the future.
- If you want to connect your device through a wireless interface, check the **Enable Wireless Interface** box. The wireless setting is disabled by default when the base station is shipped, so you **must** check this box in order to configure the base station’s wireless interface.
- Select **Ad-Hoc** if you are using a direct, peer-to-peer network, or select **Infrastructure (Via an Access Point)** if your network is connected via a wireless access point.
- The Alice 5 device comes with default TCP/IP settings. You should change these settings to suit your network.
 - a. In the TCP/IP Address field, type in the unique TCP/IP address for your Alice 5 device. The Alice 5 device, like your computer, needs to be connected to your lab or hospital’s computer network in order to exchange data with the computers on that network.

Note: *If you set up your Alice 5 network on its own subnet, you may not need to change the device's IP address to a unique address. Each Alice 5 device has its own unique wired and wireless IP address based on the serial number on the device, so changing the device's IP address will not be necessary if you use this type of configuration.*

Note: *If you do not know the TCP/IP address for your Alice 5 device, contact your network administrator.*

- b. Type in the correct Subnet Mask for your Alice 5 device. A subnet mask is like a filter that is applied to a message's destination IP address. Its objective is to determine whether the local network is the destination network. On TCP/IP networks, subnets consist of all devices whose IP addresses have the same prefix.

Note: *If you do not know what subnet you are on, contact your network administrator.*

- c. If your Alice 5 device is not on the same subnet as your computer, you need to enter the correct Gateway address in the **Gateway** field. Enter the IP address of your network's Gateway (such as a router), which is used to allow for contact between multiple networks. If your network does not have a Gateway, then leave this field blank.

Note: *If you do not know the correct Gateway address, contact your network administrator.*

- If you are using the device on a wireless network, set your Wireless Encryption settings and general settings.
 - a. The Service Set Identifier (SSID) is the unique name shared among all points in a wireless network. The SSID is required if your Alice 5 base station is connected through a wireless interface. It is case sensitive and must not exceed 32 characters. Make sure this setting is the same for all points in your wireless network.

Note: *Contact your network administrator if you do not know the correct SSID.*

- b. If you selected **Ad-Hoc** for the wireless network mode, you will need to select the **Channel** you are using in the Wireless General Settings. All devices on the network must share the same channel in order to function correctly. There are 11 possible channels that you can choose from. Similar to channels on a telephone, you can choose a channel that does not have much traffic on it to ensure that the wireless connection speed is as fast as possible. Enter any number from 1-11. If you are not sure what channel to choose, contact your network administrator.

Note: *If you select **Infrastructure** for the wireless network mode, you will not need to select a channel. The **Channel** field will be grayed out.*

- c. You can choose from three levels of encryption: **Off** (no encryption), **On (64 bits)**, or **On (128 bits)**.
Off means that there is no security for the data being transferred on the wireless network between the base station and the computer.
On (64-bit) encryption allows you to enter a 10-character key in the **Key** field. The longer or more complicated the key, the more security the encryption may achieve.
On (128-bit) encryption allows you to enter a 26-character key in the **Key** field, which provides even greater network security.
- d. If you've enabled encryption, type in the appropriate key (10 characters for 64-bit encryption or 26 characters for 128-bit encryption). The key can consist of any number ranging from 0 to 9 and/or any letter ranging from A to F.

Note: *All points in your wireless network must use the same key to utilize encryption.*

- Click **Next** once you are finished updating your settings.

The Acquisition Data Recipient screen appears, as shown in Figure 3–20.

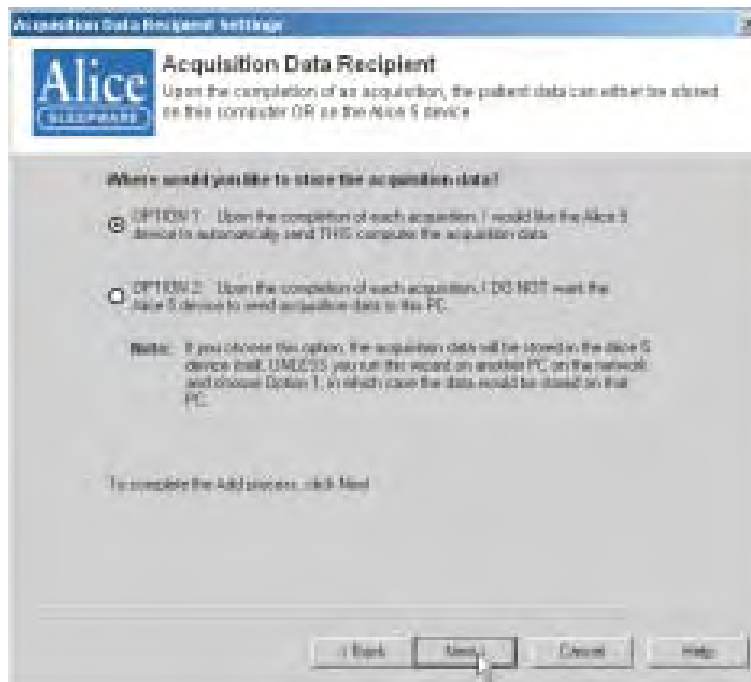

Figure 3–20 Acquisition Data Recipient Screen

9. Select where you want to store your data, and then click **Next**.
 - Select **Option 1** to store the data on your computer.
 - Select **Option 2** if you do not want the data stored on this computer. The data will be stored on the base station, unless you run this wizard again on a different computer and designate that computer as the data recipient.

Note: *If you want data from the Alice 5 device to be sent to another computer, you **must** run this Wizard on another computer in the network and choose Option 1 for that computer.*

10. If the wireless interface is disabled (because you did not check the **Enable Wireless Interface** box in Figure 3–19), the Wireless Interface Disabled screen appears, as shown in Figure 3–21.

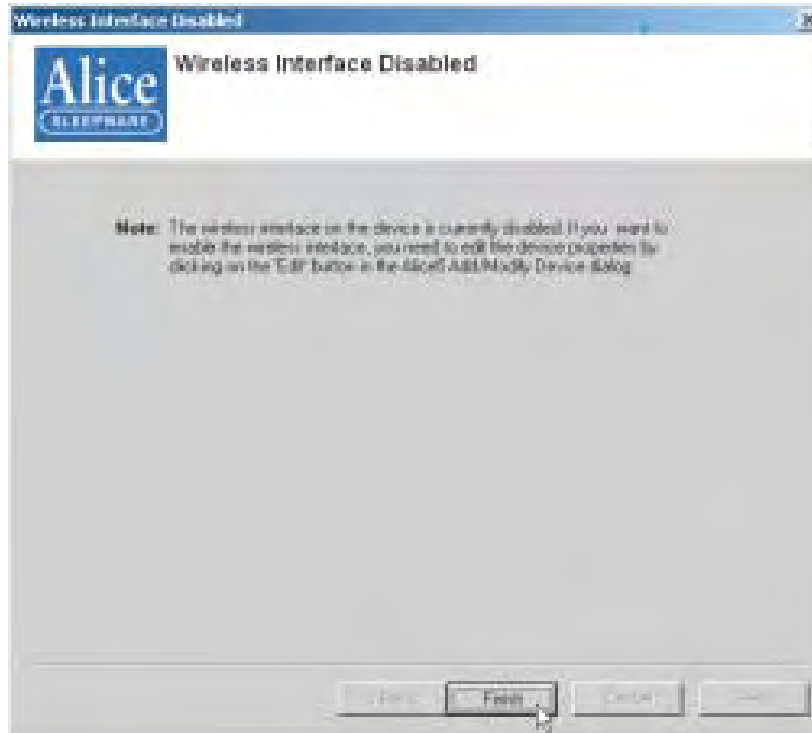

Figure 3–21 Wireless Interface Disabled Screen

This screen indicates that the wireless interface on the Alice 5 device is currently disabled. To enable the wireless interface, you will need to edit the device properties by clicking on the **Edit** button in the Alice 5 Add/Modify Device dialog box. See the *Alice Sleepware User's Guide* for more information.

Note: This screen will not appear if the wireless interface has been enabled.

11. Click **Finish** to complete the process of adding a device.
12. The Alice 5 Device List screen appears, displaying the devices that are configured on your computer. The device you just added should appear in the list, as shown in Figure 3–22.



Figure 3–22 Alice 5 Device List Screen

Additionally, once the device is successfully added, a Room button appears in your Alice Sleepware starter bar, indicating the device's status, as shown in Figure 3–23.



Figure 3–23 Alice 5 Device Status Indicator

Note: You can also edit devices through the Alice 5 Configuration Wizard and delete or view device properties through the Add/Modify Device screens. For more information, refer to the Alice Sleepware User's Guide.

Running Data Acquisitions

This chapter describes how to set up the patient so the data you need will be properly recorded, and instructs you on how to start and stop an acquisition. See Chapter 5 for information on the channels that can be recorded, and see the *Alice Sleepware User's Guide* for detailed instructions on using the software.

4.1 Overview

The Alice Sleepware software allows you to view and score data acquisitions while an acquisition is in progress. It can also download and organize the data after an acquisition has been recorded. Data acquisitions are sorted by patient identity (e.g., name and ID number), thus providing tracking of patient recording history. Multiple acquisitions performed on one patient may be easily located within the database.

Using Alice Sleepware, you can view raw waveform data in various time and montage formats. A detailed view of the recording can be seen by scrolling through the data. You may select the channels displayed on the screen and the color of the raw data, and print any raw data screen or groups of screens. Global patterns or trends for the recording may be viewed via the use of 1-hour or 10-hour summary screens. You can view video of the patient while they sleep, and you can save streaming video or snapshots along with the sleep data.

Alice Sleepware automatically detects physiologic events such as apnea, hypopnea, snoring, periodic limb movements, heart rate, arrhythmia, pH, and arousal. Events may also be distinguished according to their context (e.g., an apnea with an associated heart rate or saturation decrease). Alice Sleepware also recognizes a number of neurological events for staging adult sleep and cardio-respiratory patterns or activity for staging infant sleep.

You can validate detected events, add additional events, remove events, or change the event type, duration, or position of a detected event. Based upon the validation, Alice Sleepware computes relevant statistical values. The values may be displayed in a report format that is user-configurable. You can print the reports immediately or display them for on-screen review. You can also design custom report formats using the custom report feature.

4.2 Patient Setup

Note: *Only trained personnel should use the Alice 5 system.*

Once you have installed your Alice 5 equipment and the Alice Sleepware software, you are ready to begin collecting data. You will need to attach the appropriate patient sensors from the headbox to the patient to acquire the data you need.

Note: *The Alice system supports the placement of EEG sensors using 10-20 Electrode Placement standards only. The 10-20 Electrode Placement standards were developed to provide consistent application of EEG sensors for recording brain wave data. This system is based on measurements from four standard points on the head: the nasion, theinion, and the left and right periauricular points. You should mark and prepare each position before actually applying the electrodes.*

The age of the patient determines the acquisition type and the type of data collected. There are two acquisition types:

- **Infant** – The patient age for this acquisition type is less than six months. During recording of an Infant acquisition, the base station scores sleep using cardio-respiratory stability and actimetry. Likewise, after recording, Alice Sleepware scores sleep using cardio-respiratory stability and actimetry.
- **Adult** – The patient age for this acquisition type is six months or older. During recording of an Adult acquisition, the base station doesn't score sleep. After the recording, Alice Sleepware scores sleep using EEG and EMG data (by default).

You can collect EEG data for Infant acquisition types, but Alice Sleepware does not use it to score Pneumo sleep stages because EEG patterns are not fully developed until after humans reach the age of six months.

The acquisition type is different from the sleep scoring method. After the recording, you can determine (using Alice Sleepware) whether sleep is scored using Neuro or Pneumo sleep stages. By default, the Alice Sleepware software associates adult acquisitions with Neuro sleep stages and infant acquisitions with Pneumo sleep stages.

See Chapter 5, *Understanding Channels*, for information about the channels that the Alice 5 equipment supports. See Figures 1–4 and 1–6 for the locations to attach devices to the Alice 5 equipment. You can attach sensors to the patient in any order.

Note: *If you have sensors from auxiliary devices such as pH machines, oximeters, apnea monitors, etc., follow the manufacturer's instructions for attaching the sensors to the patient.*

4.2.1 Attaching EEG Electrodes

You should attach the EEG electrodes specified by your facility's protocol and based on the configuration you choose. Table 4–1 lists the typical EEG sites from which data is collected during a sleep study.

Table 4–1 Typical EEG Sites for Collecting Data

Site	Description
Fp1	Left Frontal Polar EEG
Fp2	Right Frontal Polar EEG
Fz	Frontal Zero EEG (mid-line)
F3	Left Frontal EEG
F4	Right Frontal EEG
F7	Left Anterior Temporal EEG
F8	Right Anterior Temporal EEG
Cz	Central Zero EEG (mid-line)
C3*	Left Central EEG
C4*	Right Central EEG
Pz	Parietal Zero EEG (mid-line)
P3	Left Parietal EEG
P4	Right Parietal EEG
T3	Left Temporal EEG
T4	Right Temporal EEG
T5	Left Posterior Temporal EEG
T6	Right Posterior Temporal EEG
A2*	Right Reference (right ear)
A1*	Left Reference (left ear)
Ground	Isoground
O1*	Left Occipital EEG
O2*	Right Occipital EEG
* Recommended by Rechtschaffen and Kales	

Complete the following steps to attach the EEG sensors to the patient:

1. Following the manufacturer's recommendations, attach the EEG leads to the patient's scalp according to your facility's procedures.

Note: *Respironics recommends that you use standard gold-cup electrodes for all EEG connections.*

2. Decide whether you want to set the sensors up contralaterally or ipsilaterally. In the U.S., adult studies use a contralateral setup, while infant studies always use an ipsilateral setup. In Europe, an ipsilateral setup is used.
 - Ipsilateral setups: Plug the A1 reference electrode lead (on the left side of the patient's head) into the A1 input on the left side of the headbox, and plug the A2 reference electrode lead (on the right side of the patient's head) into the A2 input on the right side of the headbox.
 - Contralateral setups: Plug the A1 reference electrode lead (on the left side of the patient's head) into the A2 input on the right side of the headbox, and plug the A2 reference electrode lead (on the right side of the patient's head) into the A1 input on the right side of the headbox.
3. Plug the main EEG electrode leads into the appropriate connectors on the Alice 5 headbox.
4. Place the Isoground electrode on the center of the patient's forehead, and plug the lead into the Isoground input on the Alice 5 headbox.

Caution: *If you use an EEG Isoground, do not use the left ECG lead.*

Figure 4–1 shows the locations of the EEG inputs on the Alice 5 headbox.

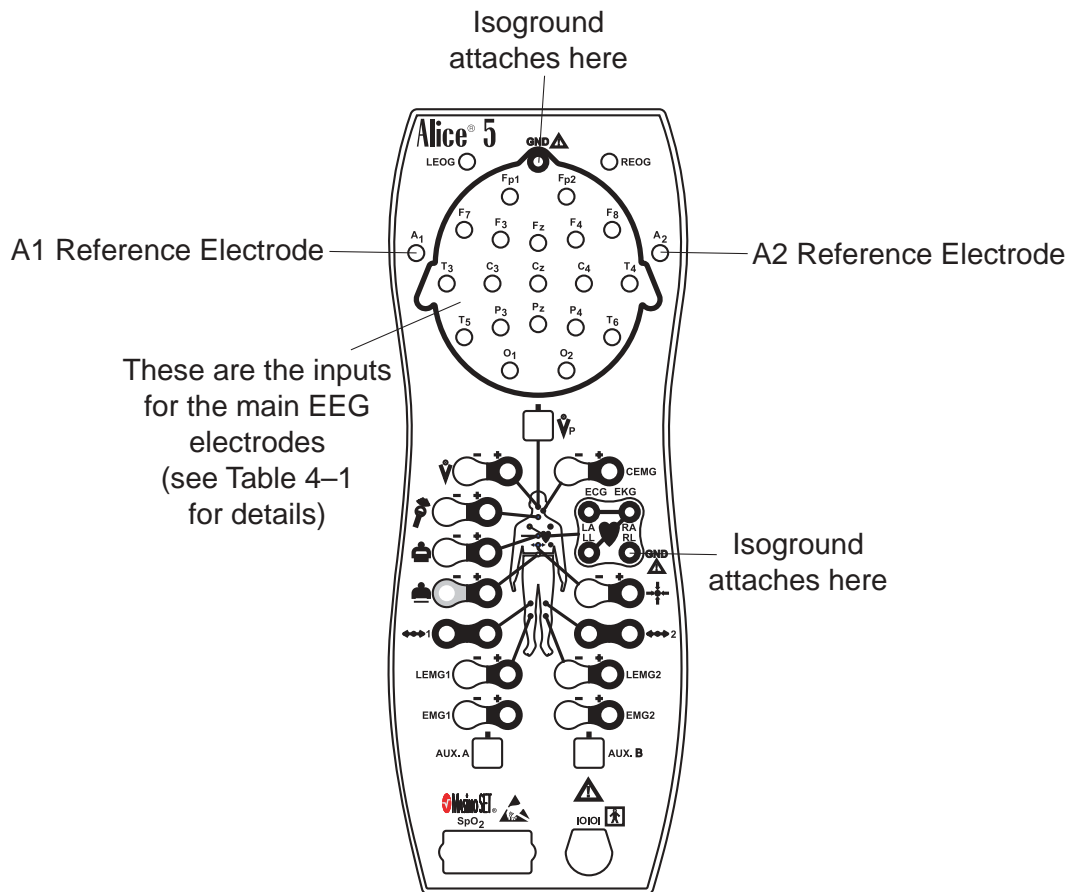

Figure 4–1 EEG Inputs on the Alice 5 Headbox

4.2.2 Attaching ECG Electrodes

The Alice 5 system supports a single lead ECG or a 6-lead ECG. The single lead ECG uses two or three wires from the headbox (the right leg is optional, depending on whether an EEG Isoground is also used with the patient). The 6-lead ECG uses three or four wires from the headbox (right leg optional), and Alice calculates the six channels by cross-referencing the signals.

Table 4–2 lists the wire colors.

Table 4–2 ECG Standard Protocols

Type	Lead Number	Colors
North American Headbox (according to AAMI, AHA-Code, or US Code)		
Single Lead ECG	Lead II	RA (right arm) = White LA (left arm) = Black RL (right leg) = Green Note: Do not connect the RL lead if you are using an EEG Isoground.
6-Lead ECG	Lead I	RA (right arm) = White LA (left arm) = Black RL (right leg) = Green Note: Do not connect the RL lead if you are using an EEG Isoground.
	Lead II	RA (right arm) = White LL (left leg) = Red
International Headbox (according to IEC-Code or EU-Code)		
Single Lead ECG	Lead II	RA (right arm) = Red LA (left arm) = Yellow RL (right leg) = Black Note: Do not connect the RL lead if you are using an EEG Isoground.
6-Lead ECG	Lead I	RA (right arm) = Red LA (left arm) = Yellow RL (right leg) = Black Note: Do not connect the RL lead if you are using an EEG Isoground.
	Lead II	RA (right arm) = Red LL (left leg) = Green

Complete the following steps to attach the ECG electrodes to the patient:

1. Refer to Table 4–2 and choose the standard protocol for your area.
2. Snap the ECG leads onto adhesive electrode patches.
3. Attach the patch for the right arm to the top right side of the patient’s chest, approximately one inch (2.54 cm) below the collarbone.
4. Attach the patch for the left arm to the top left side of the patient’s chest, approximately one inch (2.54 cm) below the collarbone. The green lead is for the ECG Ground. For a single-lead ECG, you are finished with this procedure. If you are doing a 6-lead ECG, proceed to Step 5.
5. Attach the patch for the right leg on the patient’s right side at the lowest rib. Do not place the patch forward toward the patient’s stomach; it should be placed directly on the patient’s side.
6. Attach the patch for the left leg on the patient’s left side at the lowest rib. Do not place the patch forward toward the patient’s stomach; it should be placed directly on the patient’s side.

Caution: *If you use an EEG Isoground, do not use the left ECG lead.*

7. Plug the other ends of the ECG leads into the appropriate locations on the Alice 5 headbox, shown in Figure 4–2.

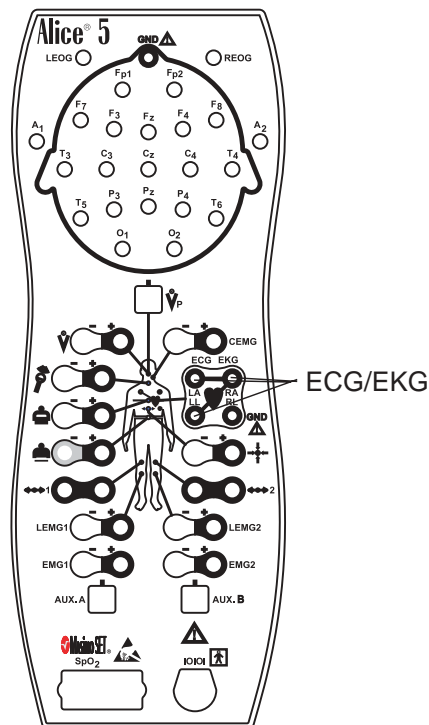

Figure 4–2 ECG Inputs on the Alice 5 Headbox

4.2.3 Attaching Chest and Abdomen Effort Sensors

Complete the following steps to attach the chest and abdomen sensors to the patient:

Note: *If you want to use another method for monitoring an infant's breathing effort (for example, an apnea monitor), follow the manufacturer's guidelines for attaching the sensors.*

1. Place the chest effort belt around the patient's chest so that the Velcro® is in the center of the chest and the black fasteners are evenly aligned with the patient's nipples. The connector should hang straight in front of the patient.
2. Plug the lead into the Alice 5 headbox.
3. Place the abdominal belt around the patient's stomach so that the vinyl part of the sensor is directly over the navel and does not rotate around the torso. The fasteners on the belt should be aligned with the patient's hips. The connector should hang straight in front of the patient.

Warning: *For infants, do not tighten the belt to the point of impeding the infant's breathing. Also, check the tension of the effort belts before and after feedings. As the infant eats, his or her belly may expand and the belts may become uncomfortably tight.*

4. Plug the lead into the Alice 5 headbox.

Figure 4–3 shows the chest and abdomen sensor locations on the headbox.

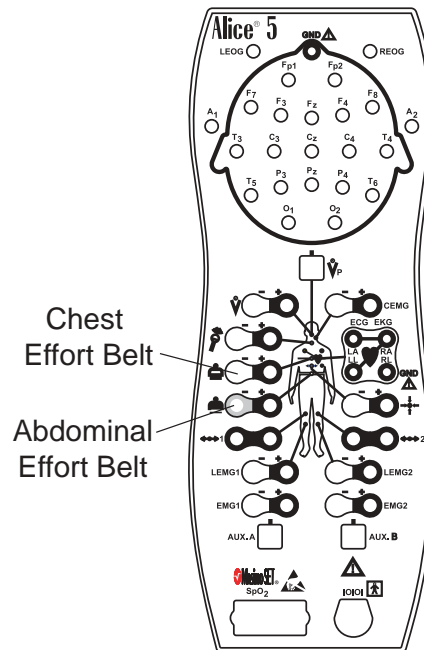

Figure 4–3 Chest and Abdomen Sensor Inputs on the Alice 5 Headbox

4.2.4 Attaching the EOG and EMG Electrodes

4.2.4.1 EOG Electrodes

Complete the following steps to attach the EOG electrodes to the patient.

1. Attach the EOG leads to the patient.
2. Plug the leads into the appropriate inputs on the headbox, as shown in Figure 4–4.

4.2.4.2 Leg EMG Electrodes

1. Place the Leg EMG leads on the patient according to your facility's specifications. There should be two leads on each limb to be monitored. Using only one lead per limb can result in a faulty signal.
2. Plug the pair of leads for each limb into the appropriate inputs on the headbox, as shown in Figure 4–4.

4.2.4.3 Chin EMG Electrodes

1. Attach the Chin EMG to the patient.
2. Plug the lead into the Chin EMG input on the headbox, as shown in Figure 4–4.

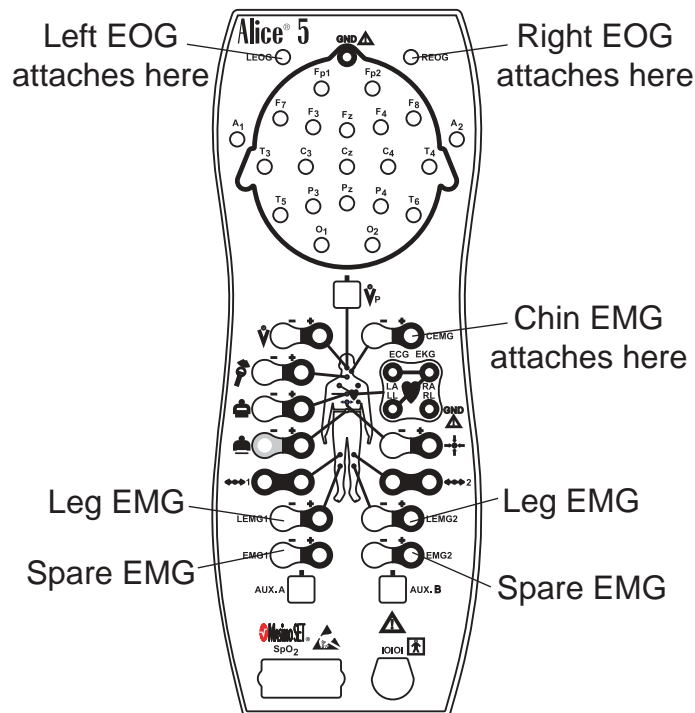

Figure 4–4 EOG and EMG Inputs on the Alice 5 Headbox

4.2.5 Attaching the Airflow Sensor

Complete the following steps to attach the airflow sensor to the patient:

1. Make sure you have the proper size sensor for your patient; both adult and infant sizes are available.
2. For the pressure-based sensor, position the nasal pressure cannula above the upper lip with the cannula protruding slightly into the nostrils. Trim if necessary per the manufacturer's guidelines.
3. For the thermistor sensor, position the sensor so that the flexible tabs fit under the nostrils. Pinch the tabs back 90° so that they are comfortable, yet not touching the skin and not protruding into the nares. The tabs bend out, away from the patient's face. The logo on the thermistor sensor is readable to the technician if the sensor is applied properly.

Caution: Use caution when placing the sensor on the patient. To avoid cuts or irritation to the skin, do not place the sensor too close to the nares.

4. Drape the leads over the patient's ears and connect the input to the Alice 5 headbox.
5. If desired, tape the leads to the patient's cheeks to help hold the sensor in place.

Figure 4–5 shows the location of the airflow sensor inputs on the headbox.

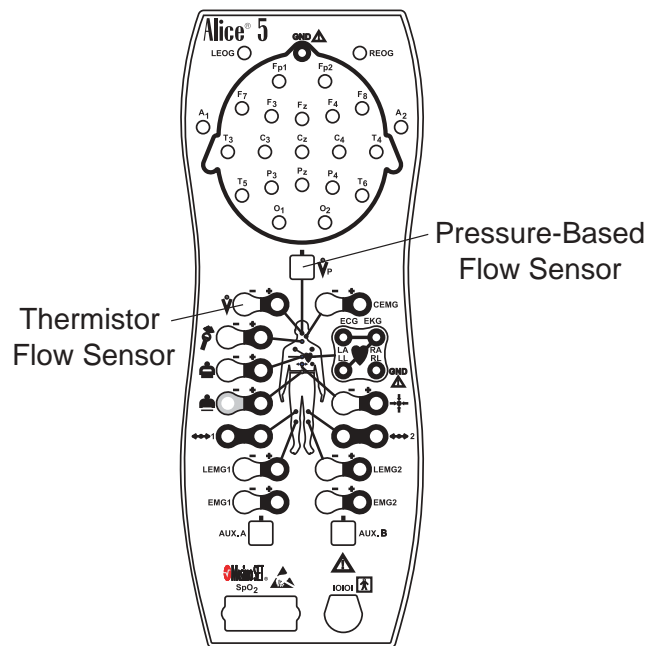

Figure 4–5 Airflow Sensor Inputs on the Alice 5 Headbox

Note: You may have additional sensors from auxiliary devices such as pH machines, oximeters, apnea monitors, etc. These can be connected to the auxiliary input ports on the back of the Alice 5 base station. See Chapter 1 for more information about the auxiliary input ports. Follow the manufacturer's instructions for attaching these sensors to the patient.

4.3 Starting an Acquisition

Before you start running an acquisition, you should review your cable connections and check your equipment as specified below.

4.3.1 Check Your Cable Connections

Review your cable connections as described below before starting an acquisition.

1. Check the sensor connections.

Verify that each sensor is plugged into the appropriate connector on the Alice 5 headbox. Refer to Figure 1–6 and Section 4.2, *Patient Setup*, for more information.

Verify that the Patient Cable is connected properly from the headbox to the base station. See Figures 2–10 and 2–11.

2. Check the auxiliary device connections (if applicable).

Verify that each auxiliary device is connected to the base station using the auxiliary input specified during the channel setup. See Chapter 5, *Understanding Channels*, for more information.

3. Check the base station connections.

If you are using a wired network connection, make sure the ethernet cable is inserted into the ethernet port on the back of the base station, as described in Chapter 2, *Alice 5 Hardware Setup*. Use one of the following cables:

- CAT-5 Crossover Cable – Connects the base station directly to the computer running Alice Sleepware software
- CAT-5 Patch Cable – Connects the base station to a switch or ethernet connector

4.3.2 Check Your Equipment Performance

You should verify that the Alice 5 equipment is operating properly before starting an acquisition. Check impedance and calibration by completing the following procedures.

4.3.2.1 Check Impedance Using the Alice Sleepware

The Alice 5 allows you to view impedance values at anytime during your study without impacting the physiological data that is being recorded. You won't lose any physiological signals when viewing impedance. To check impedance, complete the following steps:

1. Set up the appropriate sensors.

Note: The impedance feature works for the EEG, EOG, ECG, and EMG channels.

2. Check all of the required cable connections as described in Section 4.3.1.
3. Start an acquisition as described in Section 4.3.3.
The Alice equipment begins capturing data from the sensors.
4. Click on the **Imped.** button while viewing the acquisition through Sleepware.

The Sleepware software continuously displays the impedance value for each channel. The channel tabs to the left of each channel displayed indicate the impedance value by color:

- A red tab indicates a high impedance value (a poor connection).
- A dark green tab indicates a moderate impedance value (a fair connection).
- A light green tab indicates a low impedance value (a good connection).

Note: The channel label tab always indicates the impedance status, regardless of whether or not you have pressed the **Imped** button. The actual impedance value is displayed when you press **Imped**.

Note: The threshold values for impedance are user-configurable.

Note: The impedance values are also available for review after the acquisition is recorded.

5. Use the information in Table 4–3 to determine whether further action is needed.

Table 4–3 Electrode Impedance

Impedance	Recommended Action
> 10 Ohms	Replace the electrode using your lab's procedures.
Between 5k Ohms and 10k Ohms	Consider changing the electrode using your lab's procedures.
< 5k Ohms	None. The sensor has a good connection.

4.3.2.2 Check Calibration

1. Set up the sensors as described in Section 4.2.
2. Connect all of the required cables and check the connections as described in Section 4.3.1.
3. Start an acquisition as described in Section 4.3.3.

The Alice equipment begins capturing data.

4. In the On-line View window that appears, click on the **Calib.** button in the toolbar to generate a 100 mV signal on the ECG, EEG, EMG, and EOG channels. The Alice Sleepware displays the calibration signal in the waveform.
5. Let the process run for at least 30 seconds, then click the button again.

Check Bio-Calibration

1. Set up the sensors as described in Section 4.2.
2. Connect all of the required cables and check the connections as described in Section 4.3.1.
3. Start an acquisition, as described in Section 4.3.3.
The Alice 5 equipment begins capturing data.
4. Ask the patient to lie on his or her back with arms along the body, eyes closed, and breathing regularly and gently. Test the sensors by asking the patient to follow the instructions in Table 4-4 below.

Table 4-4 Checking the Sensors

Sensor	Action
EOG	Without moving their head, have the patient close the eyelids and slowly move the eyes right and left repeatedly for ten seconds. Next, have the patient close the eyelids and slowly move the eyes up and down for ten seconds.
Chin EMG	Have the patient relax the jaw for five seconds, then contract the jaw by biting for three seconds, then relax again. Repeat this three or four times.
Microphone	Have the patient breathe at a steady rhythm for 15 seconds while making a snoring sound during inspiration, or have the patient count from 1 to 10.
Abdominal and chest effort, thermistor or pressure cannula airflow.	Have the patient breathe through the nose at a steady rhythm for five seconds, then repeat by breathing through the mouth. Next, have the patient hold their breath for five seconds and then release.
Leg EMG	Have the patient contract a calf muscle for one second, then relax for one second; repeat five times. Repeat for the other calf. Have the patient point their toes, bend forward, hover, and repeat.
EEGs	Have the patient open the eyelids, relax, and look straight ahead for ten seconds. Then, have the patient close the eyelids, relax, and keep eyes facing straight ahead for ten seconds.

4.3.3 Starting an Acquisition

To start the data acquisition, complete the following steps:

1. Configure the Communication Settings for connection to the Alice 5 device you are using (see the *Alice Sleepware User's Guide* for instructions on configuration).
2. If the Alice Starter module is not already running on your computer, double-click on the Alice Starter icon ().

The name of your device appears in the Starter bar at the top of the computer screen, along with the words “Awaiting Acquisition” as shown in Figure 4–6.



Figure 4–6 Starter Bar and Device Awaiting Acquisition

3. Click on the name of the device.
The Acquisition Launch screen appears as shown in Figure 4–7.

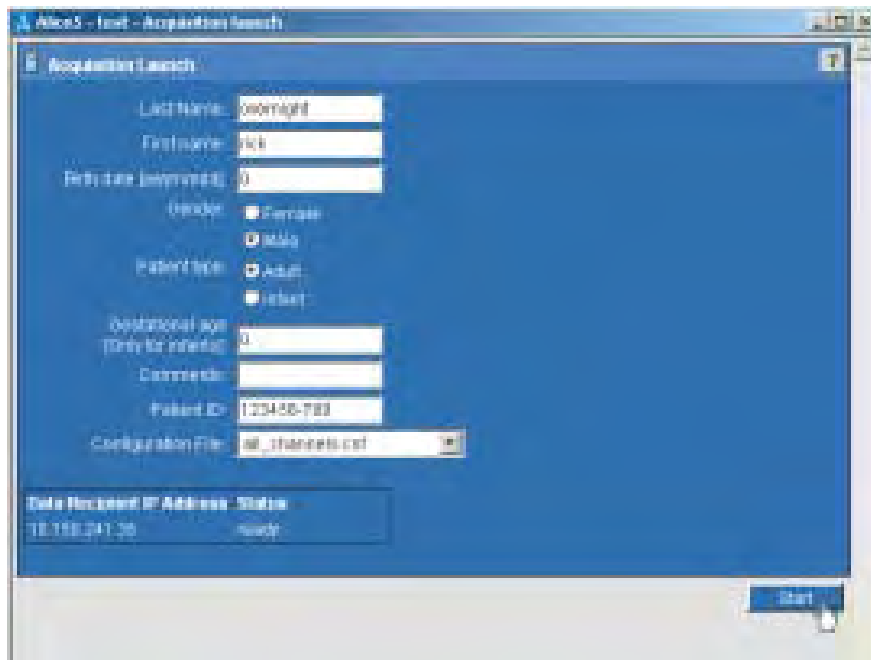

Figure 4–7 Acquisition Launch Screen

4. Click on **Start** to begin the acquisition.
The On-Line View screen appears, displaying all of the acquisition data. Green on the Alice Starter bar and the On-Line View screen indicates that the connection is successful and the acquisition is recording.

Note: *It is recommended that you start an acquisition through the Sleepware software. However, if this is not available, you can press the **Record Start/Stop** button on the base station. The Record LED is green while the base station records data.*

Refer to the *Alice Sleepware User's Guide* for additional information on starting acquisitions.

4.2.4 Stopping an Acquisition

To stop an acquisition, click the **Stop** button on the On-Line View screen in Sleepware.

Note: *It is recommended that you stop an acquisition through the Sleepware software. However, if this is not available, you can press the **Record Start/Stop** button on the base station twice to stop the acquisition. The Record LED turns off when the base station stops recording data.*

Understanding Channels

Channels refer to the different types of data collected by the auxiliary devices and sensors connected to the patient. The set of channels used in any particular sleep study is referred to as a configuration.

You can configure the channels based on the type of information you need to collect for the study. Once you set up the patient and have the data coming in from the channels you configured, you can use the Alice Sleepware to filter channels, create a montage, etc. Refer to the *Alice Sleepware User's Guide* for information on how to build configurations and create montages.

There are four types of Alice 5 channels:

- Headbox channels
- Base Station auxiliary channels
- Therapy device channels
- Derived channels

These are discussed in the sections that follow.

5.1 Headbox Channels

The channels available on the Alice 5 headbox are shown in Figure 5–1.

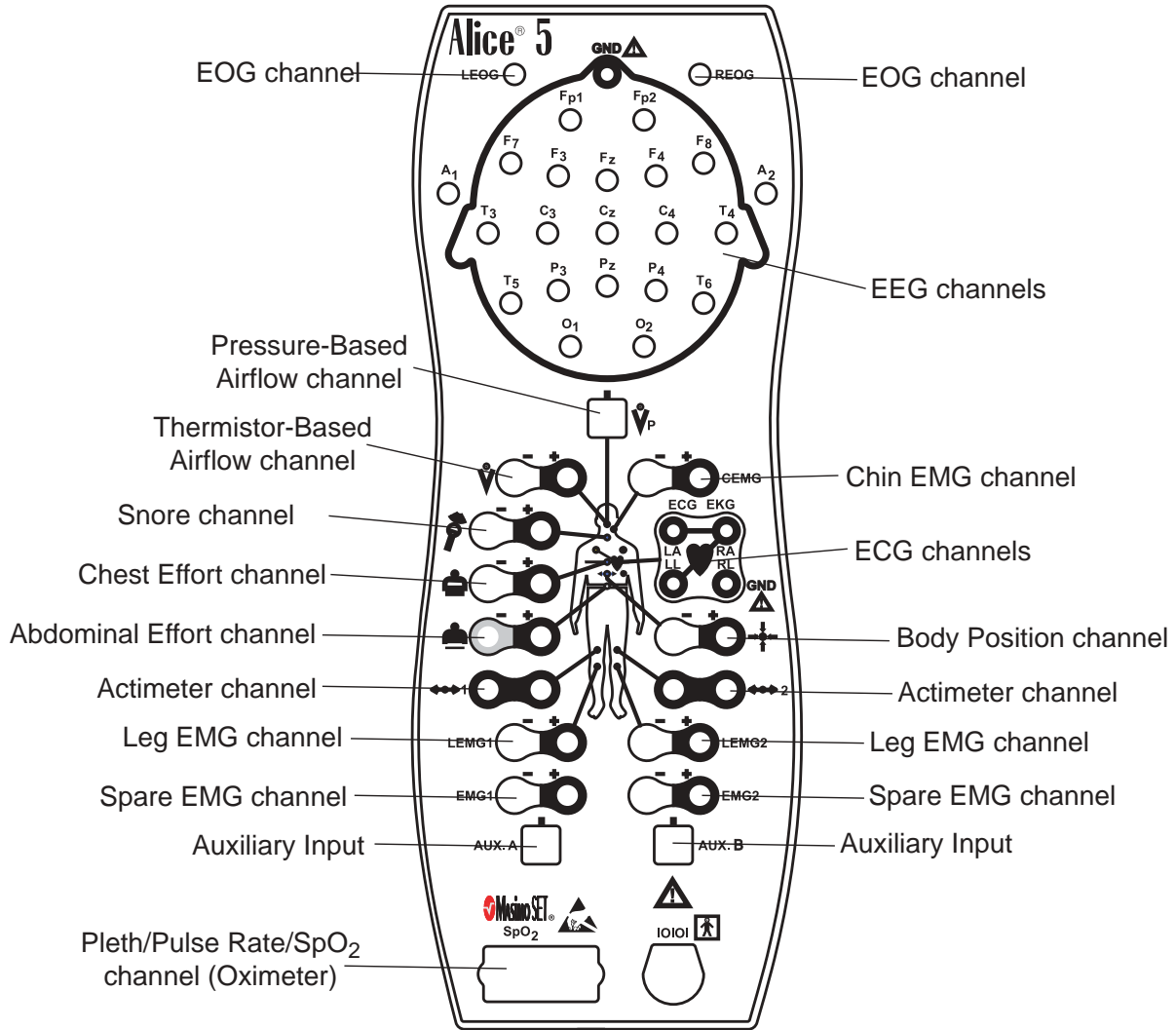

Figure 5–1 Headbox Channels

Table 5–1 provides the following information about each of the headbox channels:

- The **Channel** column lists the name of the channel.
- The **Channel Quantity** column tells how many inputs are available on the Alice 5 headbox for each channel.
- The **Sample Size** (in bits) column specifies the bit resolution for the channel being acquired.
- The **Recorded Frequency** (in Hertz) column tells you how often the data is recorded per second. Many channels have several frequency rates available. You can choose how often you want these channels to record through the Alice Sleepware.
- The **Range** column specifies the range of values to which the data corresponds.
- The **Units** column specifies the unit of measure for each channel.

Table 5–1 Headbox Channels

Channel	Channel Quantity	Sample Size (bits)	Recorded Frequency (Hz)	Range	Units
Actimeter	2	8	1	N/A	N/A
Airflow (pressure-based)	1	8, 10, 12, 16	10, 100, 200	±68.3	mV
Airflow (thermistor-based)	1	12, 16	10, 100, 200	±68.3	mV
Body Position	1	8	1	N/A	N/A
ECG	2 (physical) 6 (computed - 2 phy./4 leads)	8, 10, 12, 16	200, 500	±6.6	mV
EEG	19	10, 12, 16	100, 200	±.33	µV
Effort, abdominal	1	12, 16	10, 100, 200	N/A	N/A
Effort, chest	1	12, 16	10, 100, 200	N/A	N/A
EMG, chin	1	10, 12, 16	100, 200	±3.3	mV
EMG, leg	2	10, 12, 16	100, 200	±3.3	mV
EMG, spare	2	8, 10, 12, 16	200	±3.3	mV
EOG	2	8, 10, 12, 16	100, 200	±3.3	mV
Snore	1	8, 10, 12, 16	200	±18	mV
Pleth (Masimo Oximeter)	1	16	100, 200	N/A	N/A
Pulse Rate (Masimo Oximeter)	1	8, 10, 12, 16	1	25 to 240	BPM
SpO ₂ (Masimo Oximeter)	1	10	1, 10, 100, 200	70 to 100	%
Auxiliary Channels	2	12	10, 100, 200	±1.65	V

Each physical input channel is described in more detail below:

1 Actimetry

The actimetry channel type is used to sense motion signals from the patient. Actimetry is one of the channels by which the Alice Sleepware scores sleep in infant configurations, so it is a necessary channel in an infant configuration. The channel may also be used in adult configurations, but is usually not as important because EEG is available for scoring sleep.

With Alice 5, you can set customized parameters for this channel using the Alice Sleepware. Please refer to Table 5–1 for a detailed description of actimetry channel features. After customizing your configuration, you can use the Label function to enter a text description for your configuration of up to eight characters.

2 Airflow (Pressure-based or Thermistor-based)

The airflow channels are used to display data from a device that measures the patient's airflow. You can use the airflow sensor channel type by connecting a Respironics thermistor or pressure cannula airflow sensor to the headbox.

Note: *If you label this channel “Flow,” the Alice Sleepware can scan the data and automatically score apneas and hypopneas. Refer to the Alice Sleepware User’s Guide for more information.*

You can customize parameters for this channel. Refer to Table 5–1 for a detailed description of airflow channel features. After customizing your configuration, you can use the Label function to enter a text description for your configuration of up to eight characters.

Note: *Therapy device or auxiliary airflow channels are also available when you connect a Respironics therapy device to the COM 1 serial port on the back of the base station, or when you connect a third-party airflow sensor to an auxiliary input on the base station. See Sections 5.2 and 5.3 for more information.*

3 Body Position

The body position channel tells you the orientation of the patient's body in the bed. The body position sensor can report five possible positions:

- Supine (patient is sleeping on their back)
- Prone (patient is sleeping on their stomach, facedown)
- Right side
- Left side
- Upright

You can select customized parameters for this channel. Please refer to Table 5–1 for a detailed description of Body Position channel features. After customizing your configuration, you can use the Label function to enter a text description for your configuration of up to eight characters.

4 ECG

The ECG channel type is used to display data from an electrocardiogram channel. To use this channel, connect an ECG electrode to the ECG inputs on the headbox as needed. See Chapter 4 for additional information.

You can set customized parameters for this channel. Please refer to Table 5–1 for a detailed description of ECG channel features. After customizing your configuration, you can use the Label function to enter a text description for your configuration of up to eight characters.

Note: *An auxiliary ECG channel is also available when connecting an ECG monitoring device to one of the auxiliary inputs on the back of the base station. See Section 5.2 for more information.*

Note: *The RR channel is used to display R-wave to R-wave data that Alice computes from the ECG input signal. See Section 5.4 for more information about the RR channel.*

5 EEG

The EEG channel type is used to display data from an electroencephalogram channel.

Note: *The Alice system supports the placement of EEG sensors using 10-20 Electrode Placement Standards only. For more information, see Chapter 4.*

You can select customized parameters for this channel. Please refer to Table 5–1 for a detailed description of EEG channel features. After customizing your configuration, you can use the Label function to enter a text description for your configuration of up to eight characters.

Selecting the Reference Specification:

In the Alice Sleepware, you can specify whether you want to set the sensors up contralaterally or ipsilaterally. In the U.S., adult studies use a contralateral setup, while infant studies always use an ipsilateral setup. In Europe, an ipsilateral setup is used.

- **Ipsilateral setups:** Plug the A1 reference electrode lead (on the left side of the patient's head) into the A1 input on the left side of the headbox, and plug the A2 reference electrode lead (on the right side of the patient's head) into the A2 input on the right side of the headbox. In Sleepware, for configurations referenced ipsilaterally (on the same side of the head), you would specify A1 for the left channel's reference electrode and A2 for the right channel's reference electrode.
- **Contralateral setups:** Plug the A1 reference electrode lead (on the left side of the patient's head) into the A1 input on the right side of the headbox, and plug the A2 reference electrode lead (on the right side of the patient's head) into the A2 input on the right side of the headbox. In Sleepware, for configurations referenced contralaterally (across the head), you would specify A1 for the right channel's reference electrode and A2 for the left channel's reference electrode, thus producing channels like C3A2, O1A2, etc.

Note: *The Alice 5 base station defaults to a contralateral configuration.*

6 Effort – Abdominal and Chest (Respiration)

The respiration channel type is used to display chest and abdomen effort signals and trans-thoracic impedance signals.

The Alice system provides two effort channels: thoracic effort and abdominal effort. Additional effort channels must be input using the auxiliary inputs. The Alice Sleepware scans all effort channels to detect apneas on the airflow channel. The Alice system also allows you to monitor trans-thoracic impedance, which can be acquired from an infant monitor or other auxiliary device.

You can use the effort channel type by connecting the chest and abdominal effort belts to the inputs on the headbox.

Note: Abdominal and chest effort auxiliary channels are also available if you connect a third-party respiration measuring device to an auxiliary input on the rear of the base station. See Section 5.2 for more information.

You can set customized parameters for this channel. After customizing your configuration, you can use the Label function to enter a text description for your configuration of up to eight characters.

7 EMG (Chin and Spare)

The EMG channel type is typically used to display data for the chin EMG and the two spare EMGs, but it can be used for any electromyogram channel.

Note: The Leg EMG channel type is described in #8, below.

You can select customized parameters for this channel. Please refer to Table 5–1 for a detailed description of EMG channel features. After customizing your configuration, you can use the Label function to enter a text description for your configuration of up to eight characters.

8 EMG (Leg)

The leg EMG channel type is used to display data from limb movement detection channels.

If you use both leg EMG inputs, note that the single leg EMG channel combines the data from both inputs.

You can select customized parameters for this channel. Please refer to Table 5–1 for a detailed description of leg EMG channel features. After customizing your configuration, you can use the Label function to enter a text description for your configuration of up to eight characters.

9 EOG

The EOG channel type is used to display data from an electrooculogram channel. You can select customized parameters for this channel. After customizing your configuration, you can use the Label function to enter a text description for your configuration of up to eight characters.

10 Snore

The snore channel type is used to display data from a tracheal vibration sensor. This is not a sound sensor. A typical use of this channel in sleep studies is to measure snoring. The snore input is not calibrated.

You can select customized parameters for this channel. Please refer to Table 5–1 for a detailed description of snore channel features. After customizing your configuration, you can use the Label function to enter a text description for your configuration of up to eight characters.

11 Pleth

The pleth channel type is used to display (as a waveform) changes in arterial blood flow detected by the Masimo sensor.

You can select customized parameters for this channel. Please refer to Table 5–1 for a detailed description of pulse channel features. After customizing your configuration, you can use the Label function to enter a text description for your configuration of up to eight characters.

12 Pulse Rate

The pulse rate channel type is used to display numerical data from the Masimo pulse oximeter. To use the pulse rate channel type, connect a finger probe through a patient interface cable to the oximeter connection on the headbox.

You can set customized parameters for this channel. Please refer to Table 5–1 for a detailed description of pulse rate channel features. After customizing your configuration, you can use the Label function to enter a text description for your configuration of up to eight characters.

13 SpO₂

The SpO₂ channel type is used to display blood oxygen saturation data from the internal oximeter or from an external device.

You can use the SpO₂ channel type by connecting the Masimo oximeter sensor to the oximeter connection on the headbox (see Figure 1–6).

Note: *An SpO₂ auxiliary channel is also available when you connect a third-party oximeter to an auxiliary input on the back of the base station. See Section 5.2 for more information.*

You can set customized parameters for this channel. After customizing your configuration, you can use the Label function to enter a text description for your configuration of up to eight characters.

Conversion:

You can configure parameters for this channel type so that the input signal is displayed correctly in the Alice Sleepware. See the *Alice Sleepware User's Guide* for more information.

5.2 Base Station Auxiliary Channels

There are eight auxiliary input ports on the base station. You can use these ports to connect third-party therapy or monitoring devices to the Alice 5. Depending on the auxiliary devices you use, there are many possible auxiliary input channels available. Some of the key channels that you can report on are described later in this section. See the instructions that came with your auxiliary device for information on specific channels available for that device.

5.2.1 Display Properties of Auxiliary Input Channels

There are three display types for auxiliary input channels: **Numeric**, **Graphic**, or **Grapho-Numeric**. These are used to display a signal from any device that has an analog output. Table 5.2 describes these generic display types. In the Sleepware software, you can choose which display type you want to use depending on your channel configuration. Use this table to help you decide which display type to use with a particular signal.

Table 5–2 Display Properties of Auxiliary Input Channels

Use This Channel Type...	When...	Appearance of Channel
Numeric	The unit's measurements make the most sense when viewed as a number.	Number: The line of numbers moves up and down as the values increase or decrease.
Graphic	The unit's measurements make the most sense when viewed as a waveform. The points that define the wave are representative of the numerical value received.	Waveform: Use the reference line tool in the Alice Sleepware to display data values. Note: The input signal cannot be calibrated.
Grapho-Numeric	The unit's measurements make the most sense when viewed as a waveform, but each point that defines the wave is a usable, meaningful value.	Waveform, but the input signal can be calibrated. Use the reference line tool in the Alice Sleepware to display data values.

Each auxiliary channel display property is described in greater detail below.

Graphic Display Type

The graphic display type allows you to display any signal as a waveform. Examples of such signals are airflow, effort, plethysmograph, etc. Generally, the graphic display type is designed to produce a waveform for signals whose sample values are not given in meaningful units.

Because the graphic display type is multi-purpose, the Alice Sleepware cannot analyze the data recorded on a channel using this display type. This differentiates the graphic display type from standard channel types, such as the airflow channel. Both provide waveforms, but Alice can only scan the standard channel type, not the channel using the graphic display.

See the *Alice Sleepware User's Guide* for information on how to select the graphic display type when viewing auxiliary channel data.

Grapho-Numeric Display Type

The grapho-numeric display type allows you to display any signal as a waveform, and also allows you to calibrate the input signal by converting it to a specific number of units over a defined voltage range.

Because the grapho-numeric display type is multipurpose, the Alice Sleepware cannot analyze the data recorded on a channel using this display type. This differentiates the grapho-numeric display type from standard channel types, such as the airflow channel. Both provide waveforms, but Alice can only scan the standard channel type, not the channel using the grapho-numeric display.

See the *Alice Sleepware User's Guide* for information on how to select the grapho-numeric display type when viewing auxiliary channel data.

Conversion:

You can configure parameters for this display type so that the input signal is displayed correctly in the Alice Sleepware. See the *Alice Sleepware User's Guide* for more information.

Numeric Display Type

The numeric display type allows you to display a signal from an auxiliary device as a series of numerical values. Examples of such devices are oximeters, EtCO₂ monitors, pH units, CPAP or bi-level devices, etc. Any device that has an analog output can be viewed using the numeric display type, though some signals are better viewed as graphs.

Because the numeric display type is multipurpose, the Alice Sleepware cannot analyze the data recorded on it. This differentiates the numeric display type from standard channel types, such as the SpO₂ channel. Both provide numerical data, but Alice can only scan the standard channel type, not the channel using the numeric display type.

See the *Alice Sleepware User's Guide* for information on how to select the numeric display type when viewing auxiliary channel data.

Note: *The default frequency for numerical data is 1 Hz, as this is the maximum frequency at which the screen in the Alice Sleepware can display numerical data.*

Conversion:

You can configure parameters for the numeric display type so that the input signal is displayed correctly in the Alice Sleepware. See the *Alice Sleepware User's Guide* for more information.

5.2.2 Base Station Auxiliary Channel Descriptions

Table 5.3 provides the following information about the auxiliary input channels available on the base station:

- The **Channel** column lists the name of the channel.
- The **Channel Quantity** column tells how many inputs are available on the Alice 5 headbox for each channel.
- The **Sample Size** (in bits) column specifies the bit resolution for the channel being acquired.
- The **Recorded Frequency** (in Hertz) column tells you how often the data is recorded per second. Many channels have several frequency rates available. You can choose how often you want these channels to record through the Alice Sleepware.
- The **Range** column specifies the range of values to which the data corresponds.
- The **Units** column specifies the unit of measure for each channel.

Table 5–3 Auxiliary Input Channels

Channel	Channel Quantity	Sample Size (bits)	Recorded Frequency (Hz)	Range	Units
Auxiliary Analog Inputs	8	12	grapho-numeric 10, 100, 200 numeric 1, 10, 100, 200	± 1.25	V

With the Alice 5, you have the capability to generate reports on several auxiliary channels, including SpO₂, CPAP, EPAP, IPAP, EtCO₂, and pH. For information about the SpO₂ channel, see Section 5.1. For information about the CPAP, EPAP, and IPAP channels, see Section 5.3.

The EtCO₂ and pH channels are described below.

Note: *There are many other auxiliary channels available with the Alice 5 system, depending on the auxiliary device you are using. Refer to the instructions packaged with the auxiliary device for further information.*

1 EtCO₂ (End Tidal CO₂)

The EtCO₂ channel is used to display an end tidal carbon dioxide signal from an EtCO₂ monitor.

An EtCO₂ monitor is an auxiliary device for the Alice system. Therefore, the signal must be input via an auxiliary input on the rear of the base station (see Figure 1–4).

Note: *In order to connect to Alice 5 equipment, an EtCO₂ monitor must have an analog output.*

You can select customized parameters for this channel. After customizing your configuration, you can use the Label function to enter a text description for your configuration of up to eight characters.

Conversion:

You can configure parameters for this channel type so that the input signal is displayed correctly in the Alice Sleepware. See the *Alice Sleepware User's Guide* for more information.

2 pH

The pH channel type is used to display data from a pH measuring device.

Connect the pH channel signal to an auxiliary input on the back of the base station (see Figure 1–4).

You can select customized parameters for this channel. After customizing your configuration, you can use the Label function to enter a text description for your configuration of up to eight characters.

Conversion:

You can configure parameters for this channel type so that the input signal is displayed correctly in the Alice Sleepware. See the *Alice Sleepware User's Guide* for more information.

5.3 Therapy Device Channels

If you are connecting a Respironics therapy device to the COM 1 serial port on the back of the base station or a third-party therapy device to one of the auxiliary input ports on the base station, several therapy device channels are available. This section describes the therapy device channels that are available for reporting. Depending on the therapy device you are using, other channels will be available as well. Refer to the instructions packaged with your therapy device for further information.

The Alice 5 system is compatible with the following Respironics therapy devices:

- Aria LX
- BiPAP Pro
- Duet LX
- Harmony
- HeartPAP
- REMstar Auto
- REMstar Pro
- REMstar Pro with C-Flex
- Synchrony
- Virtuoso LX

Note: *If your therapy device is not listed here, contact Respironics Customer Service department to determine if it is compatible with the Alice 5 system.*

The therapy device channels that are available for reporting are described below.

1 CPAP

The CPAP channel type is used to display pressure signals from CPAP machines or Bi-level pressure devices in CPAP mode. You can customize the CPAP channel type to accommodate most CPAP machines. Although a generic Numeric display type can be used to record CPAP pressure, using the CPAP channel type allows the Alice Sleepware to analyze the channel and produce a CPAP summary report.

You can select customized parameters for this channel. After customizing your configuration, you can use the Label function to enter a text description for your configuration of up to eight characters.

You can use the CPAP channel type with either of the following configurations:

- Where a Respironics therapy device is connected to a serial port on the rear of the base station (see Figure 1–4 for serial port location).
- Where a third party CPAP device is connected to an auxiliary input on the rear of the base station (see Figure 1–4 for auxiliary port location).

Conversion:

When the base station receives the CPAP channel type through an auxiliary input, you can configure parameters for the channel type so that the input signal is displayed correctly in the Alice Sleepware. See the *Alice Sleepware User's Guide* for more information.

2 EPAP

The EPAP channel type is used to display bi-level positive airway pressure signals from bi-level pressure devices. These devices sense, through the use of an integral transducer, if the patient is either inhaling or exhaling. If the patient is exhaling, the bi-level pressure unit supplies less airway pressure. The low pressure is called Expiratory Positive Airway Pressure (EPAP). If the patient is inhaling, the bi-level pressure unit supplies more airway pressure. The high pressure is called Inspiratory Positive Airway Pressure (IPAP).

You can use the EPAP channel type with either of the following configurations:

- Where a Respironics therapy device is connected to a serial port on the rear of the base station (see Figure 1–4).
- Where a third-party bi-level pressure device is connected to an auxiliary input on the rear of the base station (see Figure 1–4).

You can select customized parameters for this channel. After customizing your configuration, you can use the Label function to enter a text description for your configuration of up to eight characters.

Conversion:

When the base station receives this channel type through an auxiliary input, you can configure parameters for the channel so that the input signal is displayed correctly in the Alice Sleepware. See the *Alice Sleepware User's Guide* for more information.

3 IPAP

The IPAP channel type is used to display bi-level positive airway pressure signals from bi-level pressure devices. These devices sense, through the use of an integral transducer, if the patient is either inhaling or exhaling. If the patient is exhaling, the bi-level pressure device supplies less airway pressure. The low pressure is called Expiratory Positive Airway Pressure (EPAP). If the patient is inhaling, the bi-level pressure device supplies more airway pressure. The high pressure is called Inspiratory Positive Airway Pressure (IPAP).

You can use the IPAP channel type with either of the following configurations:

- Connect a Respironics therapy device to a serial port on the back of the base station (see Figure 1–4).
- Connect a third-party bi-level pressure device to an auxiliary input on the back of the base station (see Figure 1–4).

You can select customized parameters for this channel. After customizing your configuration, you can use the Label function to enter a text description for your configuration of up to eight characters.

Conversion:

When the base station receives the IPAP channel type through an auxiliary input, you can configure parameters for the channel so that the input signal is displayed correctly in the Alice Sleepware. See the *Alice Sleepware User's Guide* for more information.

5.4 Derived Channels

There are a few channels that can also be derived from the physical inputs and the auxiliary inputs on the headbox and base station. These derived channels are described below.

1 PTT (Pulse Transit Time)

The PTT channel uses the ECG channel and the Pleth waveform to measure the time it takes between the R pulse on your ECG signal and the actual peak of the flow in your Pleth waveform. It determines the time it takes between the heartbeat and the flow of blood at the finger, as determined by the pulse oximeter.

There are three PTT channels:

- PTT (instantaneous value) – A calculation of the measured Pulse Transit Time.
- PTT mean – The average PTT measurement over a specified number of seconds.
- PTT variance – The difference between the current PTT measurement and the PTT mean.

2 RR (RR Interval)

The RR channel measures the period of time between two consecutive R waves on the ECG. An example of an RR Interval is shown in Figure 5–2.

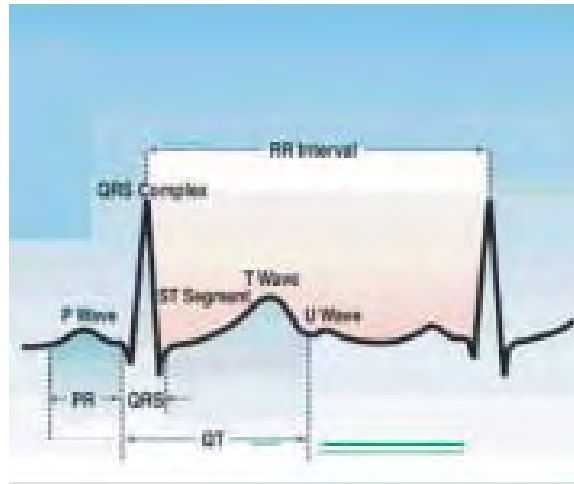

Figure 5–2 RR Interval Example

Cleaning and Maintenance

This chapter describes how to clean the Alice 5 system equipment and sensors.

Follow these general guidelines when cleaning the sensors:

- Always unplug the components from all electrical power sources when cleaning the system or any of its accessories.
- Follow the manufacturer's instructions for cleaning and disinfecting any monitoring and detecting equipment used with the Alice system.
- Unplug all sensors and cables from the Alice system equipment before cleaning.

The sections below provide specific instructions for cleaning the equipment.

6.1 Base Station, Headbox, and Patient Cable

Clean the Alice 5 base station, headbox, and patient cable with a soft, damp cloth between patients. Make sure all parts are thoroughly dry before using.

Caution: *Do not autoclave, gas, or pressure sterilize Alice 5 equipment. Do not soak or immerse the equipment in any liquid.*

6.2 Sensors

When the sleep study is finished, you should clean the sensors after removing them from the patient. Some sensors require special cleaning.

Note: *Equipment purchased from other manufacturer's may require different methods of cleaning and disinfecting.*

6.2.1 EEG Electrodes

Clean the EEG electrodes following the procedures used by your facility, in accordance with the electrode manufacturer's guidelines.

6.2.2 ECG Sensors

After one use, dispose of the stick-on ECG electrode patches. Clean the electrode lead wires with a non-alcohol based disinfectant. Clean the ECG leads with a non-alcohol based cleaner.

6.2.3 Airflow Sensors

After one use, dispose of the cannula, but keep the pressure transducer. Clean the sensor and the sensor cable with a non-alcohol based cleaner.

If using a thermistor airflow sensor, clean the sensor and the sensor cable with a non-alcohol based cleaner.

6.2.4 Snore, Actimeter, and Body Position Sensors

Clean each of the sensors with a damp alcohol cloth or wipe.

Caution: *Do not allow liquid to flow into the snore sensor.*

6.2.5 Effort Belts

The effort sensors may be wiped clean with a mild disinfectant. The belts may be washed in light detergent and water.

Note: *Follow the manufacturer's guidelines for cleaning sensors for any auxiliary devices used with the Alice 5 system.*

7

Troubleshooting

This chapter describes problems you may experience with your Alice system and provides possible solutions.

Refer to the following tables for help in dealing with hardware equipment and software installation problems you may experience, as well as issues with setting up accessories such as the video cameras and video servers.

If your problem is still not resolved after following the solutions described in this section, contact Respirationics' Customer Service for further assistance.

	Problem	Solution
Base Station and Computer Equipment Issues	1. I have connected my Alice 5 system as instructed, but the base station's Ready LED (which is the power indicator) does not light up.	Check your power cord and power supply connections to make sure they are properly plugged in. If the problem persists, try plugging the device into a different wall outlet. If the LED still doesn't light, you may have a faulty power supply or power cord. Contact Respirationics' Customer Service for additional help.
	2. The base station's Ready LED is a continuous yellow light and will not change to green.	<p>When you first plug in the device, the Ready LED will light up as yellow. This indicates that power has been supplied to the device, but it's not yet ready for use. Within 8 minutes, the light should change from yellow to green to indicate that it's ready to use. If this does not occur, the Alice 5 will automatically reboot and try again.</p> <p>Unplug the base station and plug it back in. If the light still does not change from yellow to green within 8 minutes, contact Respirationics' Customer Service to have the Alice 5 serviced.</p>
	3. I was running an acquisition when power to my Alice 5 base station was lost due to a power outage. What do I do? Will I lose any data?	The base station will automatically power up again when power is restored. The only data you will lose is a maximum of 90 seconds of data prior to the power loss plus the time during the power outage. The study automatically resumes as soon as power is restored. However, the Audio/Video will not automatically resume. You may temporarily lose your computed channels and spectral analysis data, but these can be regenerated at the end of the study through Sleepware.
	4. The computer designated as the data recipient lost power or crashed.	<p>If the data recipient computer crashes or loses power, you have a couple options. If you have another computer on the same network, simply access the Add/Modify Device menu in Sleepware from that computer and designate it as your new data recipient.</p> <p>Another option is to change the IP address of another computer on your network to the same address that was used by the data recipient computer that's no longer functioning. Once you give the new computer this same IP address, the base station will recognize it as the data recipient and will start sending data to the new computer.</p>
	5. The base station does not appear on the network when I try to add a new device through the Alice Sleepware.	<p>There could be several causes for this. Check the following:</p> <ul style="list-style-type: none"> • Verify that the computer's network interface is running and that the computer and base station are connected to the same network. • Make sure the base station is plugged in and receiving power, and check that the Ready LED on the base station is green. • Check your network cabling to make sure you are using the correct cable for your configuration. See Chapter 2 for details on what cable to use (CAT-5 Crossover or CAT-5 Patch). • If you are using a network router with your system, make sure the Alice 5 and the computer are on the same side of the router when you are adding the device. If a network router is between the base station and the computer, the protocol used between the two will not traverse the router. Another way to resolve this is to temporarily connect the base station directly to the computer, add the device, and then disconnect and set up your network as needed. Or, if you know the IP address information for the device, you can manually enter it in the Add Device wizard. <p>If the problem still occurs, contact Respirationics' Customer Service for further assistance.</p>
	6. In Alice Sleepware, an error message appears saying "The page cannot be displayed" when you try to open a new page in the software.	Make sure your network is active. If so, check your computer's proxy settings. The proxy server settings should be disabled on your computer. To disable your proxy server settings, go to Control Panel>Internet Options and click on the Connections tab. Click the LAN Settings button, and make sure the Proxy server option is deselected.

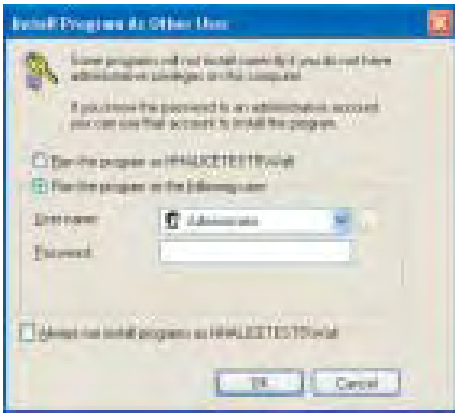
	Problem	Solution
Software Installation and Wizard Issues	7. The Alice 5 devices in my Starter Bar indicate no signal.	Check all of the items mentioned in Troubleshooting Item #5. If the problem is still not resolved, check to see if any new firewall software has been added to the computer. If so, this may be causing a conflict with the Alice Sleepware. Contact Respirationics' Customer Service if the problem persists.
	8. The software will not install on my computer.	<p>Make sure your computer meets the specifications required to run the Alice Sleepware software. If you do not have enough memory on your computer or if the computer is not compatible, the software will not properly install. Refer to the Alice Sleepware CD packaging for a list of required specifications, or contact Respirationics Customer Service for more information.</p> <p>If your computer meets all specifications and you are still having trouble installing the software, you may not be logged onto your computer as an administrator. A screen resembling the following may appear:</p>  <p>Restricted users cannot install the Alice Sleepware software. Log back onto your computer as an administrator, install the software, and then change the privileges back to restricted, as described in Chapter 3 of this manual.</p>
	9. When I try to select the Add/Modify Device option from the Alice Starter Bar, the menu item is grayed out and cannot be selected.	If you currently have an acquisition running, you cannot select the Add/Modify Device option. To add or modify a device, stop the acquisition you are running, or wait until the acquisition is complete.
	10. My computer is unable to communicate with my wireless device, or I can't enable wireless on my device.	<p>You may have multiple interfaces on your computer or your interface may be disabled. Make sure all interfaces are active on your computer.</p> <p>Check your device settings, including the IP address, channel, encryption, etc. If the wireless device settings do not match what you entered when adding the device in Sleepware, you won't be able to communicate.</p>
	11. My computer is not receiving patient data at the end of my acquisition.	Did you specify that the computer be the data recipient when you added the Alice 5 device? If not, go into the Add/Modify Device wizard and when you get to the screen where you designate the data recipient, choose Option 1 to specify that data be automatically sent to your computer.

Video Camera / Video Server Issues	Problem	Solution
	12. The video camera or server cannot be accessed from the browser.	<p>Refer to the instructions supplied with your video camera or video server for information on how to troubleshoot these problems.</p> <p>If the problem continues, contact Respirationics' Customer Service for additional assistance.</p>
	13. The power indicator on the video server is not constantly lit.	
	14. The network indicator on the video server displays red.	
	15. The status indicator on the video server is flashing red rapidly.	<p>Check your Audio/Video settings in the Alice Sleepware. You may have the wrong video camera port number specified. Select the port number that the camera you want is connected to.</p> <p>The Alice 5 system is only compatible with the Axis 2420 camera and the Axis 2400/2401 video server with an analog camera. If you are using the 2420 camera, the port number specified should be port 1. If you are using the video server, port numbers 1-4 are possible, depending on which port your camera is connected to on the server.</p>
16. I am getting video of the wrong room when viewing video through Sleepware.		

8

Specifications

8.1 Device Size

Base Station:

Dimensions – 13.5” L x 4.5” W x 12” H

Weight – Approximately 9 lbs.

Headbox:

Dimensions – 9.25” L x 4” W x 1.75” H

Weight – Approximately 3 lbs.

8.2 Classifications and Ratings

Note: *Auxiliary channels do not provide isolated inputs. Medical devices which are connected to the auxiliary inputs on the base station must be Type BF applied parts and must provide any necessary additional isolation from the base station.*

Standards Compliance

The Alice 5 system is designed to conform to the following standards: IEC 60601-1, EN 60601-1, UL 60601-1, CSA 22.2 No. 601.1, and AS 3200.1.0.

Classifications

The Alice 5 hardware is classified as follows:

- Type of Protection Against Electric Shock: Class I Equipment
- Degree of Protection Against Electric Shock: Type BF Applied part
- Degree of protection against harmful ingress of water:
 - Base Station - IPX0 (Ordinary protection against the ingress of liquids)
 - Headbox - IPX1 (Drip proof equipment)
- Mode of Operation: Continuous operation
- Not suitable for use in the presence of a flammable anaesthetic mixture with air, oxygen, or nitrous oxide

Power Requirements

The base station is powered from a single external medical grade power supply unit: Model MW 116 Power Supply (Respironics Reorder Number 1019280)

- MW116 Input: 100 to 240 VAC, 50/60 Hz 1.0 A
Output: 6.3 VDC, 5.0 A
- Base Station Input: 6.3 VDC, 5.0 A

The headbox receives its power from the base station via a cable.

- Headbox Input: 8 VDC, 600 mA

Caution: *Do not use any other power supply with the Alice 5 base station.*

Signal Input/Output

Do not connect any devices to the base station auxiliary inputs that have signal voltages greater than ± 1.25 V. Also, do not connect any equipment to the base station that violates the unit leakage current requirements.

Do not connect stereo equipment to the auxiliary inputs on the base station. These inputs are for physiological information only.

Temperature and Storage Information

	Operation	Storage
Temperature:	41° F (5° C) to 95° F (35° C)	-4° F (-20 ° C) to 140° F (60° C)
Humidity:	15% to 95% RH non-condensing	15% to 95% RH non-condensing
Atmospheric Pressure:	70 to 102 kPa	70 to 102 kPa

SpO₂ Range and Accuracy

Display: 1-100% (SpO₂ display is functional saturation.)

Calibration: 70-100% $\pm 3\%$ (± 1 Std Dev)

Saturation (% SpO₂)

- During No Motion Conditions – Neonates: 70% - 100% ± 3 digits (± 1 Std Dev)
0 - 69% unspecified
- During Motion Conditions – Neonates: 70% - 100% ± 3 digits (± 1 Std Dev)
0 - 69% unspecified

Recommended application time at a single site for SpO₂ probes: 8 hours

Pulse Rate Accuracy: ± 4 beats

Pulse Rate Calibration: 25-240 BPM

Note: *For additional information concerning the material of the Masimo probe and further specifications, refer to the Masimo packaging and documentation supplied with the probe.*

8.3 Disposal

When necessary, dispose of the system components in accordance with local regulations.

A

EMC Information

Guidance and Manufacturer's Declaration - Electromagnetic Emissions

This device is intended for use in the electromagnetic environment specified below. The user of this device should make sure it is used in such an environment.

Emissions Test	Compliance	Electromagnetic Environment - Guidance
RF emissions CISPR 11	Group 1	This device is suitable for use in all establishments, including domestic establishments and those directly connected to the public low-voltage power supply network.
RF emissions CISPR 11	Class B	
Harmonic emissions IEC 61000-3-2	Class A	
Voltage fluctuations/ Flicker emissions IEC 61000-3-3	Complies	

Guidance and Manufacturer's Declaration - Electromagnetic Immunity

This device is intended for use in the electromagnetic environment specified below. The user of this device should make sure it is used in such an environment.

Immunity Test	IEC 60601 Test Level	Compliance Level	Electromagnetic Environment - Guidance
Electrostatic Discharge (ESD) IEC61000-4-2	± 6 kV contact ± 8 kV air	± 6 kV contact ± 8 kV air	Floors should be wood, concrete or ceramic tile. If floors are covered with synthetic material, the relative humidity should be at least 30%.
Electrical fast Transient/burst IEC 61000-4-4	± 2 kV for power supply lines ± 1 kV for input-output lines	± 2 kV for supply mains ± 1 kV for input/output lines	Mains power quality should be that of a typical home or hospital environment.
Surge IEC 61000-4-5	± 1 kV differential mode ± 2 kV common mode	± 1 kV differential mode ± 2 kV for common mode	Mains power quality should be that of a typical home or hospital environment.
Voltage dips, short interruptions and voltage variations on power supply input lines IEC 61000-4-11	$<5\% U_T$ ($>95\%$ dip in U_T) for 0.5 cycle $40\% U_T$ (60% dip in U_T) for 5 cycles $70\% U_T$ (30% dip in U_T) for 25 cycles $<5\% U_T$ ($>95\%$ dip in U_T) for 5 sec	$<5\% U_T$ ($>95\%$ dip in U_T) for 0.5 cycle $40\% U_T$ (60% dip in U_T) for 5 cycles $70\% U_T$ (30% dip in U_T) for 25 cycles $<5\% U_T$ ($>95\%$ dip in U_T) for 5 sec	Mains power quality should be that of a typical home or hospital environment. If the user of the device requires continued operation during power mains interruptions, it is recommended that the device be powered from an uninterruptible power supply or a battery.
NOTE: U_T is the a.c. mains voltage prior to application of the test level.			

Guidance and Manufacturer's Declaration - Electromagnetic Immunity

This device is intended for use in the electromagnetic environment specified below. The user of this device should make sure it is used in such an environment.

Immunity Test	IEC 60601 Test Level	Compliance Level	Electromagnetic Environment - Guidance
Power frequency (50/60 Hz) magnetic field IEC 61000-4-8	3 A/m	3 A/m	Power frequency magnetic fields should be at levels characteristic of a typical location in a typical home or hospital environment.
Conducted RF IEC 61000-4-6 Radiated RF IEC 61000-4-3	3 Vrms 150 kHz to 80 MHz 3 V/m 80 MHz to 2.5 GHz	3 Vrms 3 V/m	<p>Portable and mobile RF communications equipment should be used no closer to any part of the device, including cables, than the recommended separation distance calculated from the equation applicable to the frequency of the transmitter.</p> <p>Recommended separation distance $d = 1.2\sqrt{P}$ $d = 1.2\sqrt{\frac{P}{f}}$ 80 MHz to 800 MHz $d = 2.3\sqrt{\frac{P}{f}}$ 800 MHz to 2.5 GHz</p> <p>where P is the maximum output power rating of the transmitter in watts (W) according to the transmitter manufacturer and d is the recommended separation distance in meters (m).</p> <p>Field strengths from fixed RF transmitters, as determined by an electromagnetic site survey,^a should be less than the compliance level in each frequency range.^b</p> <p>Interference may occur in the vicinity of equipment marked with the following symbol:</p> 
<p>NOTE 1 At 80 MHz and 800 MHz, the higher frequency range applies. NOTE 2 These guidelines may not apply in all situations. Electromagnetic propagation is affected by absorption and reflection from structures, objects, and people.</p> <p>^a Field strengths from fixed transmitters, such as base stations for radio (cellular/cordless) telephones and land mobile radios, amateur radio, AM and FM radio broadcast and TV broadcast cannot be predicted theoretically with accuracy. To assess the electromagnetic environment due to fixed RF transmitters, an electromagnetic site survey should be considered. If the measured field strength in the location in which the device is used exceeds the applicable RF compliance level above, the device should be observed to verify normal operation. If abnormal performance is observed, additional measures may be necessary, such as re-orienting or relocating the device.</p> <p>^b Over the frequency range 150 kHz to 80 MHz, the field strengths should be less than 3 V/m.</p>			

Recommended Separation Distances between Portable and Mobile RF Communications Equipment and This Device

This device is intended for use in an electromagnetic environment in which radiated RF disturbances are controlled. The customer or the user of this device can help prevent electromagnetic interference by maintaining a minimum distance between portable and mobile RF communications equipment (transmitters) and this device as recommended below, according to the maximum output power of the communications equipment.

Rated Maximum Power Output of Transmitter W	Separation Distance According to Frequency of Transmitter m		
	150 kHz to 80 MHz $d = 1.2\sqrt{P}$	80 MHz to 800 MHz $d = 1.2\sqrt{P}$	800 MHz to 2.5 GHz $d = 2.3\sqrt{P}$
0.01	0.12	0.12	0.23
0.1	0.38	0.38	0.73
1	1.2	1.2	2.3
10	3.8	3.8	7.3
100	12	12	2.3

For transmitters rated at a maximum output power not listed above, the recommended separation distance d in meters (m) can be estimated using the equation applicable to the frequency of the transmitter, where P is the maximum output power rating of the transmitter in watts (W) according to the transmitter manufacturer.

Note 1: At 80 MHz and 800 MHz, the separation distance for the higher frequency range applies.

Note 2: These guidelines may not apply in all situations. Electromagnetic propagation is affected by absorption and reflection from structures, objects, and people.

Limited Warranty

Respironics, Inc. warrants that the system shall be free from defects of workmanship and materials and will perform in accordance with the product specifications for a period of two (2) years from the date of sale by Respironics, Inc. to the dealer. If the product fails to perform in accordance with the product specifications, Respironics, Inc. will repair or replace – at its option – the defective material or part. Respironics, Inc. will pay customary freight charges from Respironics, Inc. to the dealer location only. This warranty does not cover damage caused by accident, misuse, abuse, alteration, and other defects not related to material or workmanship.

Respironics, Inc. disclaims all liability for economic loss, loss of profits, overhead, or consequential damages which may be claimed to arise from any sale or use of this product. Some states do not allow the exclusion or limitation of incidental or consequential damages, so the above limitation or exclusion may not apply to you.

This warranty is given in lieu of all other express warranties. In addition, any implied warranties – including any warranty of merchantability or fitness for the particular purpose – are limited to two years. Some states do not allow limitations on how long an implied warranty lasts, so the above limitation may not apply to you. This warranty gives you specific legal rights, and you may also have other rights which vary from state to state.

To exercise your rights under this warranty, contact your local authorized Respironics, Inc. dealer or contact Respironics, Inc. at:

1001 Murry Ridge Lane
Murrysville, Pennsylvania 15668-8550
1-724-387-4000



RESPIRONICS INC.®

1001 Murry Ridge Lane
Murrysville, Pennsylvania
15668-8550 USA