

**INSTRUCTION MANUAL
COMPUTERIZED LENSMETER**

CL-200

INTRODUCTION

Thank you for purchasing the TOPCON Computerized Lensmeter CL-200.

This instrument has the following features:

- High accuracy measurements with ease of operation
 - Easy to use color LCD
-

This Instruction Manual covers an overview of the TOPCON Computerized Lensmeter CL-200, basic operations, troubleshooting, maintenance and cleaning.

To ensure the efficient, safe use, read through “Safety Indications” and “Safety Precautions” and use the instrument correctly.

Keep this Instruction Manual within reach for future reference.

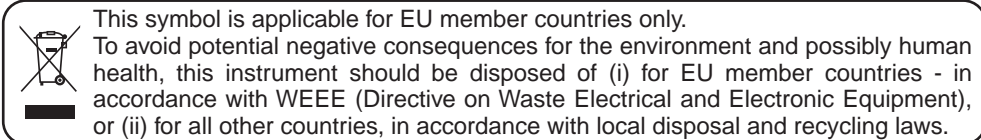

WORKING ENVIRONMENT

Indoor use Altitude up to 2,000m

Pollution degree II Temperature range: 5-40°C

Maximum relative humidity 80% for temperatures up to 31°C decreasing linearly to 50% relative humidity at 40°C

STORAGE METHOD (without package)

1. ENVIRONMENTAL CONDITIONS

Indoor use Altitude up to 2,000m

Pollution degree II Temperature range: 5-40°C

Maximum relative humidity 80% for temperatures up to 31°C decreasing linearly 50% relative humidity at 40°C

2. IF THE INSTRUMENT IS PLACED IN STORAGE, KEEP IT

- (1) Free from water splashes
- (2) Free from adverse effects due to atmospheric pressure, temperature, moisture, ventilation, sunlight, dust, salt, content, sulfur, etc.
- (3) Stable and free from vibration shock (including transportation) and insure that it is always stored in an upright position.
- (4) Free from chemicals and gases.

TRANSPORT AND STORAGE CONDITIONS (with package)

Temperature: -20°C-50°C

Humidity: 10-95%



MAINTENANCE AND CHECKS







1. Regularly maintain and check all equipment and parts.
2. When the instrument is not in use, protect the instrument by covering it with the dust cover.

DISPLAYS FOR SAFE USE

In order to encourage the safe use of this product, warnings labels are placed on the product and written in the instruction manual.

We suggest that everyone understands the meaning of the following displays and icons before reading the "Safety Cautions" and text.

| DISPLAY | MEANING |
|---|--|
|  WARNING | Improper handling or ignoring this display may lead to the possibility of death or serious injury. |
|  CAUTION | Improper handling or ignoring this display may cause personal injury or physical damage. |
| <ul style="list-style-type: none">• Injury refers to cuts, bruises, burns, electric shock, etc.• Physical damage refers to extensive damage that may involve the building, peripheral equipment and furniture. | |

| ICONS | MEANING |
|---|--|
|  | This icon indicates an action to be avoided. Specific contents are shown with words or an illustration close to the  icon. |
|  | This icon indicates a Mandatory Action. Specific contents are shown with words or an illustration close to the  icon. |
|  | This icon indicates a Hazard Alerting (Warning). Specific contents are shown with text or an illustration close to the  icon. |

SAFETY PRECAUTIONS



WARNING

| Icons | Prevention item | Page |
|-------|---|-----------|
| | To avoid fire/electric shocks, connect the power plug to a 3P AC outlet (with ground) and secure grounding. | 15 |
| | To prevent electrical shock, turn off the power switch and disconnect power cable before replacing fuses. Replace fuses with the same rating and type. | 33 |
| | To avoid electric shocks, do not attempt disassembling, rebuilding or repairing. For repairs, call your dealer. | — |
| | To avoid fire/electric shocks, do not install the instrument in a place where it may get wet. | — |
| | If there is a malfunction or if the instrument produces smoke, immediately turn OFF the POWER switch and unplug the power cable. To avoid a possible fire due to malfunction, call your dealer and ask for repairs. | — |



CAUTION

| Icons | Prevention item | Page |
|-------|---|-----------|
| | To avoid injury by falling, do not install the instrument on a slope or in an unstable place. | 15 |
| | To avoid electric shocks, do not handle the power plug with wet hands. | — |
| | This instrument has been tested (with 100-240V) and found to comply with IEC60601-1-2: 2001. This instrument radiates radio frequency energy within standard and may affect other devices in vicinity. If you have found out by turning on/off the instrument that it affects other devices, it is recommended to change the direction, keep a proper distance against other devices or change the outlet. If you have a question, consult with the selling agent. | — |

USAGE AND MAINTENANCE

Usage:

This lensmeter is an electric instrument and it must be used in accordance with its Instruction Manual.

USER MAINTENANCE

To maintain the safety and performance of the equipment, never attempt to repair or perform maintenance. These tasks should be performed by an authorized service representative. Maintenance tasks that can be performed by the user are as follows; for details, follow the manual's instructions.

OPERATING THE FUSE:

The fuse is replaceable.

For details, see page 33 of this manual.

CLEANING COVER GLASSES

For details, see page 34 of this manual.

ESCAPE CLAUSE

- TOPCON shall not take any responsibility for damages due to fire, groundquake, actions by third person, or the negligence and misuse by the user and used under unusual conditions.
- TOPCON shall not take any responsibility for damage derived from the inability to use this equipment, such as a loss of business profit and suspension of business.
- TOPCON shall not take any responsibility for damage caused by operations other than those described in this Instruction Manual.

WARNING INDICATIONS AND POSITIONS

To insure safety, warning labels are provided.

Use the equipment correctly by following the warning instructions. If any of the following labels are missing, please contact us at the address stated on the back cover.

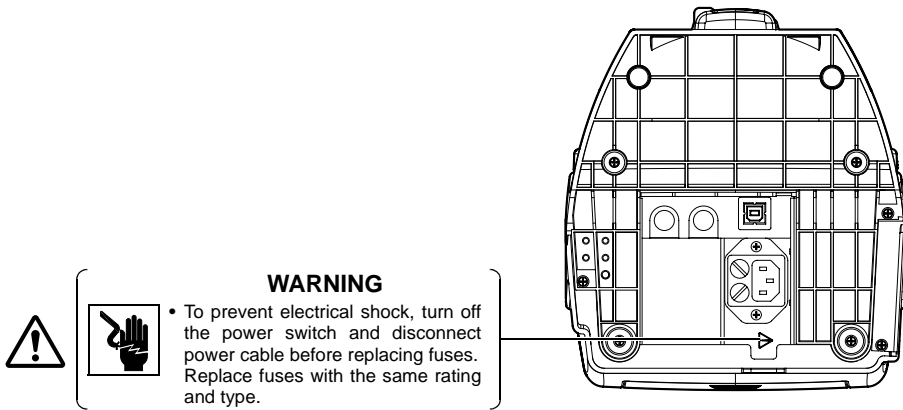

CONTENT

| | |
|--|----|
| INTRODUCTION | 1 |
| DISPLAYS FOR SAFE USE | 3 |
| SAFETY PRECAUTIONS | 4 |
| USAGE AND MAINTENANCE | 5 |
| USER MAINTENANCE | 5 |
| ESCAPE CLAUSE | 5 |
| WARNING INDICATIONS AND POSITIONS | 6 |
| COMPONENTS | |
| COMPONENT NAMES | 8 |
| ACCESSORIES | 9 |
| MONITOR | |
| MONITOR SCREEN | 10 |
| MENU SCREEN | 12 |
| MENU LIST | 13 |
| PREPARATION | |
| INSTALLATION | 15 |
| SETTING THE PAPER | 15 |
| USING THE INSTRUMENT | |
| MEASURING | 17 |
| AXIS MARKING (CARTRIDGE SPECIFICATION/STEEL NEEDLE SPECIFICATION) | 26 |
| PRINTING ADDITIONAL TEXTBOX (WITH PRINTER SPECIFICATION) | 28 |
| SETTING A SEQUENCE NO. | 29 |
| ABBE COMPENSATION FUNCTION..... | 30 |
| LENS PROTECTION PAD | 30 |
| COMPARTMENT SPACE..... | 30 |
| MEASURING PD (PD FITTING)(WITH PD SPECIFICATION)..... | 31 |
| MAINTENANCE | 33 |
| BEFORE REQUESTING SERVICE | |
| CAUTION MESSAGES | 35 |
| CHECK ITEMS | 35 |
| SPECIFICATIONS | |
| SPECIFICATIONS | 36 |
| WITH PRINTER SPECIFICATION | 36 |
| ELECTROMAGNETIC COMPATIBILITY..... | 37 |
| SYSTEM CLASSIFICATION | 41 |
| OPTIONAL ACCESSORIES..... | 41 |
| SHAPE OF PLUG | 42 |
| SYMBOL | 42 |
| USING THE INSTRUMENT AS A SYSTEM | |
| ON - LINE SYSTEM | 43 |
| USB | 43 |

COMPONENTS

COMPONENT NAMES

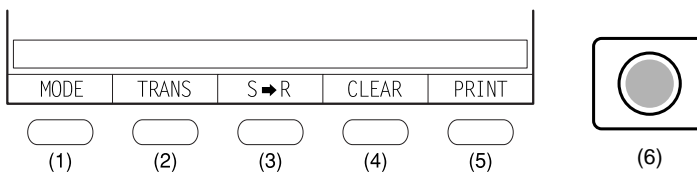
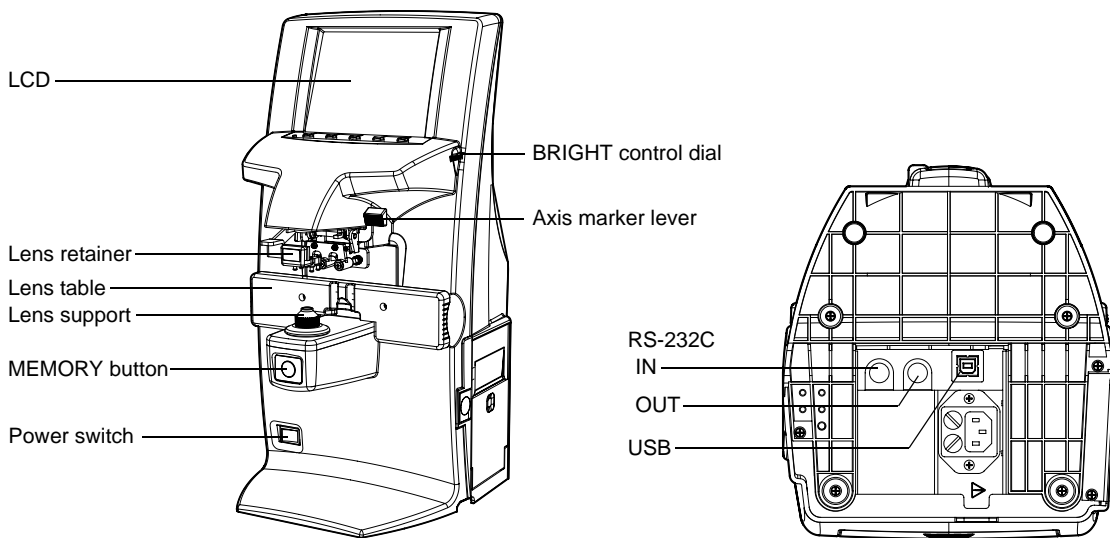



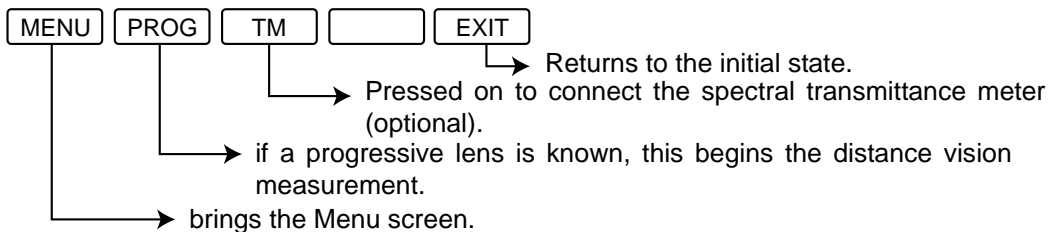

(1) Mode buttons Pressed to change the mode, and when pressed;

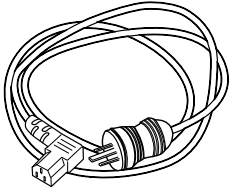
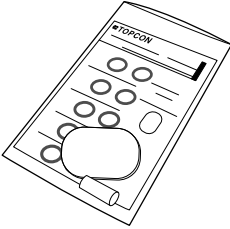
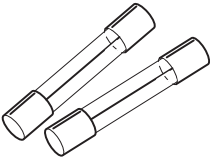
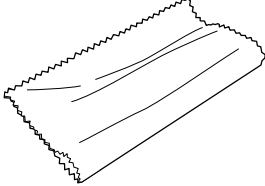
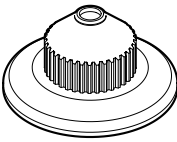

- (2) TRANS button Used to change (+) to (-) and vice versa in displayed cylinder value.
- (3) R/L button Used to designate R for right lens or L for left lens.
- (4) CLEAR button Used to delete all data in memory.
- (5) PRINT button Press to output data trough RS-232C.
Press to obtain a print out readings.
- (6) MEMORY button ● Used to store the measurement data.
Press for 3 sec and longer to turn off the back light.

ACCESSORIES

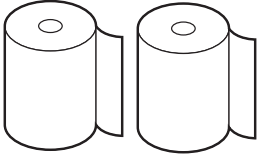
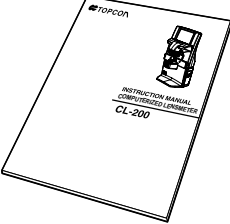
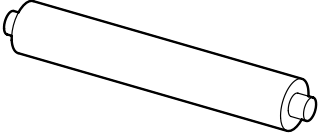
The following are standard accessories. Make sure that all these items are included (quantity).

| | |
|---|---|
| <p>Power cable (1)</p>  | <p>Lens protection pad (1)</p>  |
| <p>Fuse (2)</p>  | <p>Silicon cloth (1)</p>  |
| <p>Contact lens support (1)</p>  | <p>Dust cover (1)</p>  |
| <p>Printer paper (2) (with printer specification)</p>  | <p>Instruction manual (1)</p>  |
| <p>Printer paper shaft (1) (with printer specification)</p>  | <p>Supply ink (1) (Steel needle specification)</p>  |

MONITOR

MONITOR SCREEN

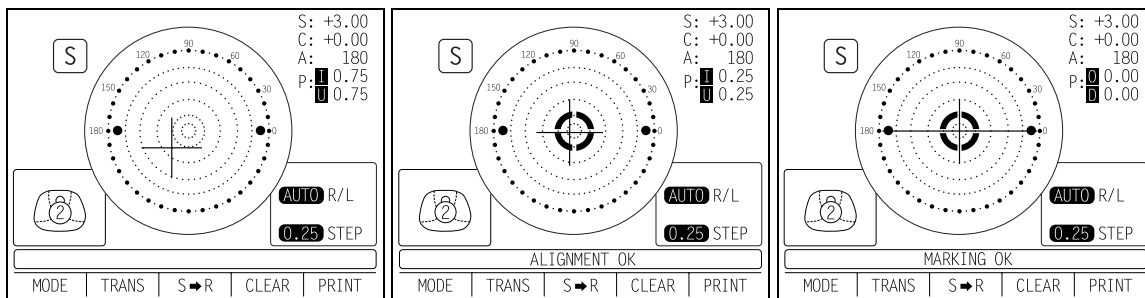

Optical center's off.
[OFF CENTER] is displayed when the optical center is off by 4D or more.

Blue: +, measurement value, S/R/L

[ALIGNMENT OK] appears when the lens is ready for measurement.

Green: +, measurement value, S/R/L

Place + in center [MARKING OK] appears, and the lateral line will extend, getting the instrument ready for marking.

Orange: +, measurement value, S/R/L

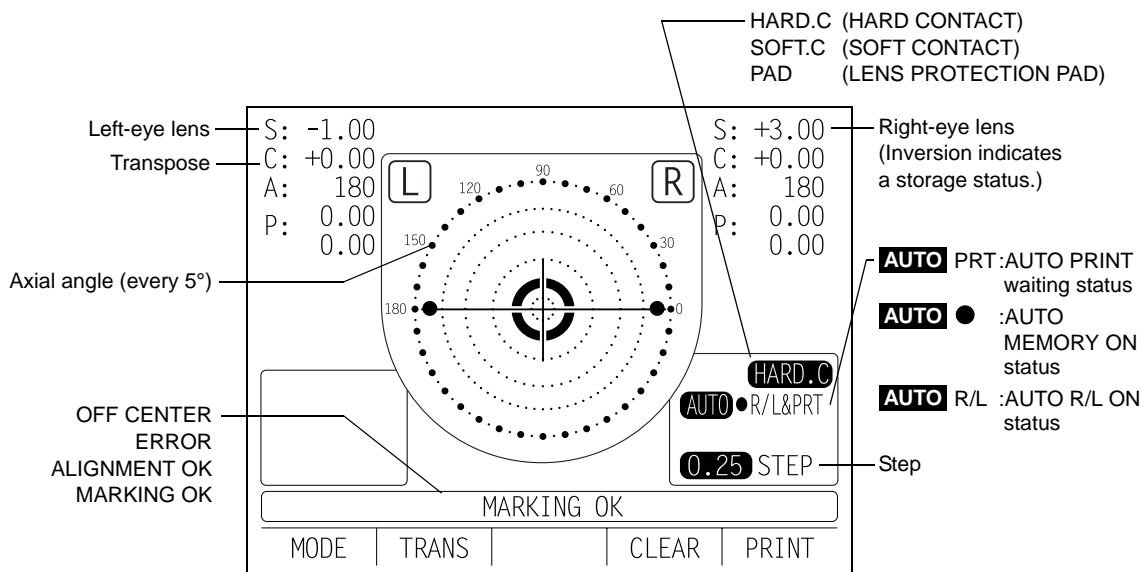

- When saved, S/R/L is inverted.
- When the measurement value turns white, the measurement is finished.
- When the measurement value is yellow, the measurement of a multi-focal lens is being performed.



The + target indicates optical center position. And it varies depending on the symbol used in the spherical equivalent power. Be noted that the target motion is different from that of Topcon telescopic lensmeters. For axis marking procedures, refer the instruction in Page 27. Don't use target's position but the prism value.

ENLARGEMENT:

When **MENU/DISPLAY/HORIZONTAL LARGE** is selected, the SCA display is horizontally enlarged to make it easier to see.

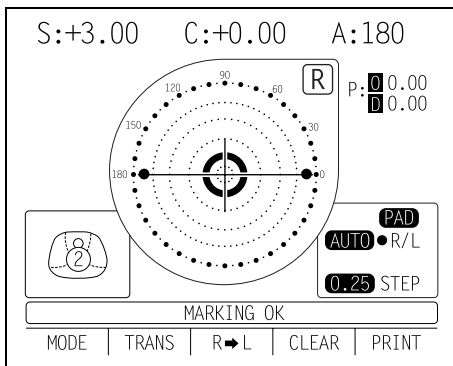

When **MENU/DISPLAY/VERTICAL LARGE** is selected, the SCA display is vertically enlarged to make it easier to see. The graphic moves to the opposite side.

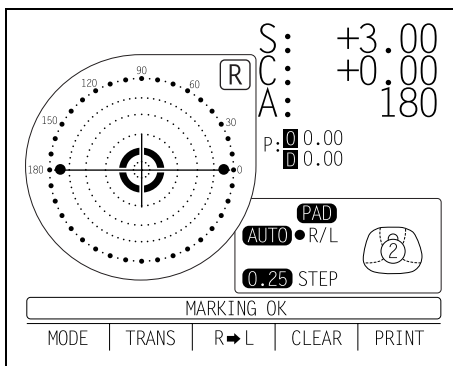

SCREEN PRINT DISPLAY: (WHEN ENLARGED)



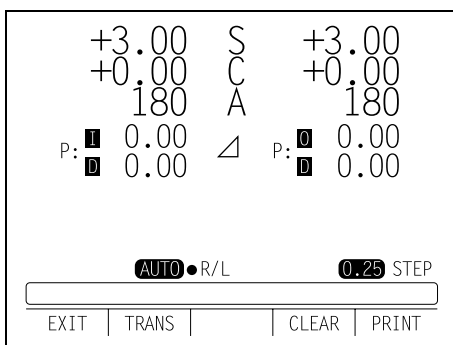

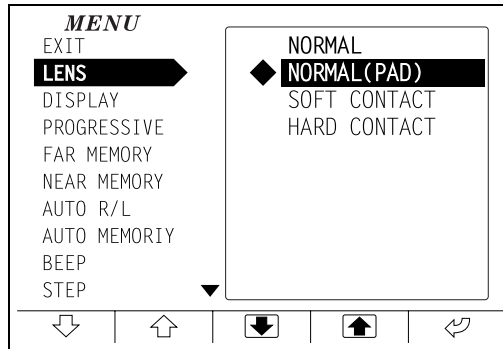

For framed lenses, of which both R and L are memorized, pressing the PRINT button enlarges the SCA of both eyes. To return to the original state, press the **EXIT** button.



MENU SCREEN



To display the "MENU" screen, press the "MODE" button then the "MENU" button. Icons will appear at the bottom of the screen. Refer to the buttons at the bottom of the screen to scroll through the Menu.

-   Selects a menu.
-   Selects the contents of each menu.
-  Changes the setting, and return to the measurement screen.
-  Selected the present menu
-  Possible to scroll

MENU LIST

| | | |
|-------------|------------------|--|
| EXIT | | Returns to the initial screen without changing settings. |
| LENS | NORMAL | Measures a normal lens. |
| | NORMAL (PAD) | Measures a normal lens wearing the lens protection pad. |
| | SOFT CONTACT | Measures a soft contact lens. |
| | HARD CONTACT | Measures a hard contact lens. |
| DISPLAY | HORIZONTAL LARGE | Horizontally enlarges the SCA display. |
| | VERTICAL LARGE | Vertically enlarges the SCA display. |
| | NORMAL | Normal display |
| PROGRESSIVE | OFF | Auto progressive recognition mode OFF. |
| | AUTO | Auto progressive recognition mode ON. |
| | PROGRESSIVE ONLY | Always begins with the Progressive zone center search mode of the progressive lens. |
| | REVERSE | Measures the diopter power with the concave side up. |
| FAR MEMORY | ON | Auto memory of distance vision measurement. |
| | OFF | Manual memory of distance vision measurement. |
| NEAR MEMORY | ON | Auto memory of near vision measurement |
| | OFF | Manual memory of near vision measurement |
| AUTO R/L | R/L | Measurement of framed lens: Auto R/L switching |
| | S/R/L | Measurement of single lens/framed lens: Auto R/L switching |
| | OFF | S/R/L switching |
| AUTO MEMORY | ON | Auto memory is ON when the lens optical axis is aligned. |
| | S : OFF R/L : ON | Auto memory OFF at measurement of single lens. It is ON at measurement of framed lens. |
| | OFF | Auto memory OFF. |
| BEEP | ON | Buzzer sounds when a measured value is stored or a button is pushed. |
| | OFF | Buzzer OFF |
| STEP | 0.25 | 0.25-step measurement. |
| | 0.12 | 0.12-step measurement. |
| | 0.01 SERVICE | 0.01-step measurement. |
| A:STEP | 5 | Rounds axial angle settings to 5° |
| | 1 | |
| PRISM | NO DISPLAY | No prism display. |
| | X-Y | Rectangular coordinate display |
| | P-B | Polar coordinate display |
| | (mm) | mm display at PD/OFF |

| | | |
|---|----------------------------------|--|
| CYLINDER | MIX + - | Mixed display Plus-fixed display Minus-fixed display |
| AUTO OFF | YES NO | Power save ON Power save OFF |
| RS-232C | NEW FORMAT OLD FORMAT STD1 | External output (NEW FORMAT) External output (OLD FORMAT) External output (STD FORMAT) |
| TM DATA IN | OFF ON(TM→CL→PC) | Pressed on to connect the spectral transmittance meter (optional). |
| SEQ.NO. | SET | Serial No. print mode |
| ABBE At several destination : d-line setting *1 | NORMAL MID LOW | 50-60 Abbe 40-50 Abbe 30-40 Abbe |

with printer Type (add to the above)

| | | |
|------------|---------------|--|
| PRINTER | ON OFF | Printer output ON Printer output OFF |
| AUTO PRINT | ON OFF | Auto memory output (S: When the lens is removed) R/L: When both lenses are the same class (1st/2nd near vision of distance vision) Manual memory output |
| NAME | SET | Shop name print mode |



PD Type (added to the above)

| | | |
|----|-----------|---|
| PD | ON OFF | PD value display No PD value display |
|----|-----------|---|

*1: In case of the instrument with printer type, it is displayed in next of the NAME.

PREPARATION

INSTALLATION

| | |
|--|---|
|  WARNING | To avoid fire/electric shocks, connect the power plug to a 3P AC outlet (with ground) and secure grounding. |
|  CAUTION | To avoid injury by falling, do not install the instrument on a slope or in an unstable place. |

- 1** Remove the tape from the lens support.
- 2** Remove the tape from the marking ink cartridge.
- 3** Connect the power cable to the body.
- 4** Plug the power cable into an outlet.

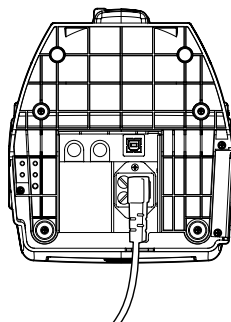
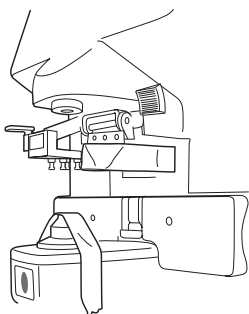

SETTING THE PAPER

- 1** Press the button and open the cover.
- 2** Insert the printer paper shaft and set the printer paper roll.



Make sure that the roll is in the right direction.

- 3** Align the printer paper with the line.

4 Close the cover.

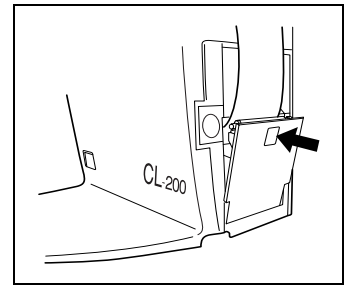
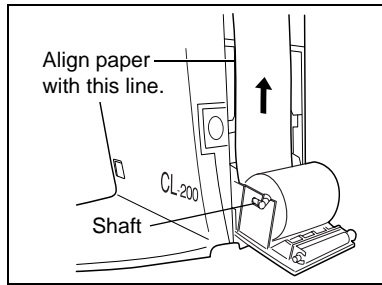
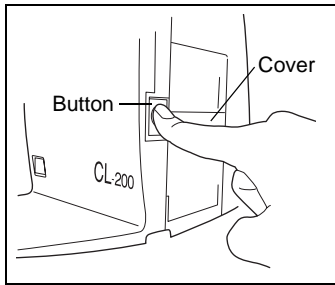

- Printer feed function : Press print button while pressing clear button.



- Do not install the instrument in a place which is exposed to direct sunlight, high temperature, humidity or dust.
- Do not install the instrument at a place exposed to intense light or on a glossy table.
- The instrument may not operate properly or "ERROR" may be displayed.
- Working environment
 - Indoor use Altitude up to 2,000m
 - Pollution degree II Temperature range: 5-40°C
 - Maximum relative humidity 80% for temperatures up to 31°C decreasing linearly to 50% relative humidity at 40°C
- Use a power of AC100-240V/±10% (50/60Hz)
- Use transient overvoltages typically present on the power.
- Do not install the equipment so that it is difficult to operate Power switch.

USING THE INSTRUMENT

MEASURING

CHECKING BEFORE MEASURING

- 1 Check to see that there is no lens on the lens support.
- 2 Turn on the power switch, and display will appear on the screen in a few seconds.



INITIAL ERROR will appear when there is a lens left on the lens support or dust left on the cover glass; a message is displayed to remove the lens or dust. And turn on power again.

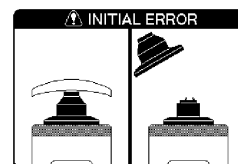

MEASURING A SINGLE LENS

- 1 Place the lens with the concave surface facing down.
- 2 Lift and place down the lens retainer to secure the lens with an accompanying hand.
- 3 ALIGNMENT OK will be displayed when the target image center is within the minimum circle (0.5Δ or smaller).
- 4 The ALIGNMENT OK mark is displayed when the target image center is reached. In the case of **AUTO** ●, "single lens" is memorized automatically. When BEEP function is ON, the buzzer will sound.
(Note) The target may move in a contrary manner immediately after the lens is placed.

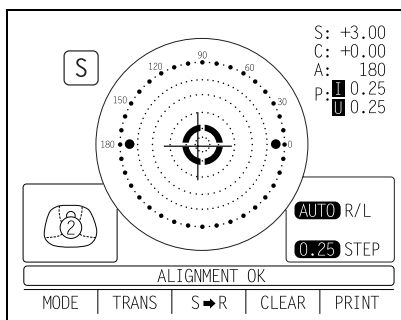

- 1 Changing measuring steps
Select on the menu screen [0.12] or [0.25].
- 2 When prism display is needed
Set as follows in the Menu screen:
[NO DISPLAY].....No display
[X-Y]Orthogonal coordinates display
[P-B]Polar coordinates display
[mm]Display by mm : It may not displayed for PD type.

- 3** When transposing is required
 Press TRANS button, and the astigmatism symbols will change.
 Press the button again, and the original data will reappear.

| | | |
|----------|---|----------|
| S: -1.50 | ➔ | S: -1.00 |
| C: +0.50 | | C: -0.50 |
| A: 90 | | A: 180 |

- 4** When storing
 Press the MEMORY button ●. [S] will turn to [S].
 When R/L designation is required
 Press the R/L button.

In the screen, [S]→[R]→[L] appears in this order.

For example, [S→R] [now → after pressing] is displayed.

- 5** When printing (with printer specification)
 Press PRINT button. When connecting with computer, data is transmitted.

MEASURING A FRAMED LENS

- 1** Pull the lens table to your side.
2 Gently, place the glass frame against the lens table for measurement.
 Alignment Place the frame against the lens table gently, and move the frame vertically and horizontally finely.

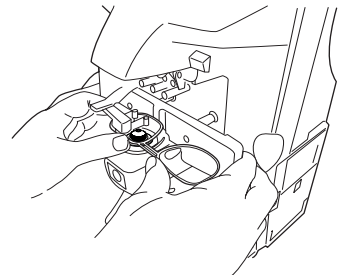

Holding the lens table back side, place the glass frame simultaneously.

- When [AUTO R/L OFF] (● AUTO R/L is not displayed):
 Press the [S→R] button.
 First align the right lens and press the Memory button ●.
 Press the [R→L] button.
 Align the left lens and press the Memory button ●.
- When [AUTO R/L / R/L] & [AUTO MEMORY/ON] is set (● AUTO ● R/L is displayed):
 *Measurement of framed lens.
 First, align the right lens to display "MARKING OK". Then the result is automatically memorized, when the right lens is hold.
 Removing the right lens will automatically move to the L measurement.
 Align the left lens, then the result is automatically memorized, when the left lens is hold.
- When [AUTO R/L S/R/L] & [AUTO MEMORY S:OFF R/L:ON] is set:
 *Measurement of single lens/framed lens
 Press the [S→R] button. (● AUTO ● R/L is displayed)
 At first, align the right lens to display "MARKING OK". Then the result is automatically memorized, when the right lens is hold.
 Removing the right lens will automatically move to the L measurement.
 Align & hold the left lens. The result is automatically memorized.

MEASURING A PROGRESSIVE LENS

- Measuring a progressive lens **MENU/PROGRESSIVE/AUTO**
 Measures a single focal lens or a progressive lens, which otherwise is difficult.
 Under this mode, a graphic operation procedure is displayed at the bottom left.

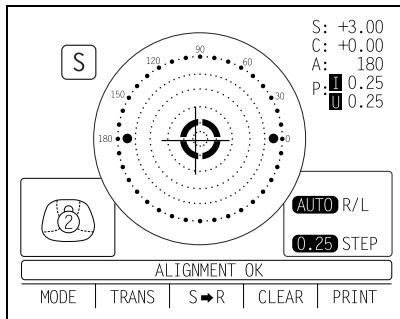

- Select **MENU/PROGRESSIVE/AUTO** with MENU button, and a single focal lens will be told from a progressive focal lens, which is not easy from appearance.
- Under this mode, the graphic operation procedure appears at the lower left on the screen.
- Measure the lower frame center (position ①); do not move the frame during measurement.
- Measure the frame center (position ②); do not move the frame during measurement. If the difference is over 0.50D or more, the screen changes.

The figure blinks and the size changes.

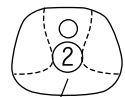
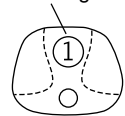

The figure blinks and the size changes.

Entering the progressive measurement mode (when not using the automatic progressive recognition mode)

- Pressing the MODE button and then the PROG button.

Or, when **MENU/PROGRESSIVE/PROGRESSIVE ONLY** is set, always the progressive lens mode begins.

MEASURING A PROGRESSIVE LENS FOR DISTANCE VISION (EXCLUDING HORIZONTAL PRISM PRESCRIPTION LENSES) NEAR MEMORY/OFF

- 1 During distance vision measurement, a graphic display, as shown below, is shown on the screen.

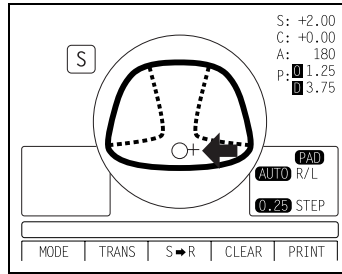

Move the lens slowly from the progressive zone at the lens center to lens top, and bring the "+" into the circle ○.

- 2 When the distance vision measurement is obtained and saved, the screen automatically changes to the near vision measurement display. (The distance vision region can be easily detected, as you repeat moving and stopping the lens little by little at measuring.)

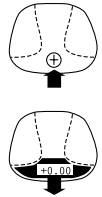

By pressing the Memory button ●, you may manually store the result of distance vision power measurement. The screen will then switch to the near vision measurement.

When MENU/FAR MEMORY/OFF is selected as the default setting, the result of the distance vision measurement is not automatically stored. With this setting, you must press the Memory button ● to save the distance vision.

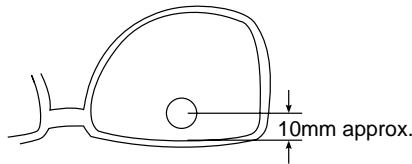

For high-power lenses, sometimes the distance vision region cannot be easily detected. In this case, obtain the measurement in the approximate position that is shown on the above, and then press Memory button ●.



For horizontal prism prescription lenses, press the MEMORY button ● at the distance reference point.

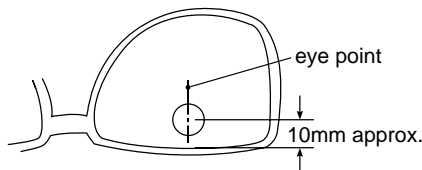

MEASURING A PROGRESSIVE LENS FOR NEAR VISION NEAR MEMORY/OFF

- 1 While watching the screen, draw out the lens table forward: the bar-meter extends and the "+" appears. To bring this "+" to the bar-meter center, swing the lens right-left and extend the bar-meter.

Indicates the maximum value that was measured

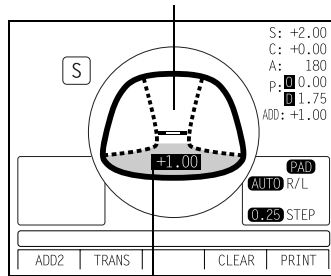

ADD value

- 2 The condition illustrated below indicates that a position outside of the progressive zone is being measured. Move the lens in the direction of the arrow to bring the "+" into the center of the progressive zone.

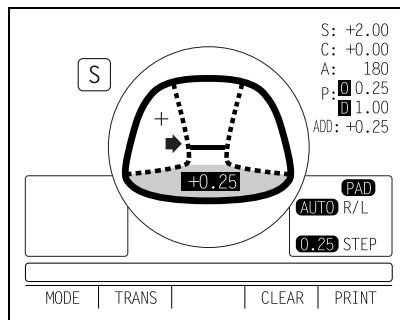

- 3 The "+" becomes larger as it comes closer to the near vision position.
- 4 By pressing the MEMORY button ●, the ADD power is saved, the progressive lens measurement is completed.

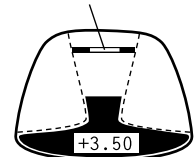

Indicates the maximum value that was measured

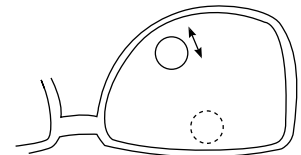

When measuring a lens mounted in a large frame, the ADD power may be higher because some lenses increase the ADD power at a position below the near vision region. Accordingly, if the lens is measured at a point lower than the near vision eye point, the ADD power reading may be higher. If you want to know the accurate prescription, it is advisable to check the measurement position at the hidden mark.



ASPHERICAL RANGE PROGRESSIVE RECOGNITION MODE

- 1 If a progressive lens is positioned so that the lens is outside of the progressive zone, the **CLEAR** icon button will change to a blinking  icon. By pressing the  button, the screen will automatically switch to the distance vision measurement screen. Then proceed with the measurement as outlined above.

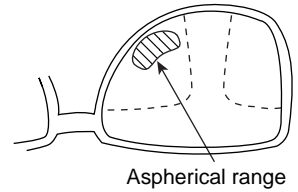

This appears when measuring the aspherical range of the progressive lens.

MEASURING BI-FOCAL AND TRI-FOCAL LENSES

- 1 Align the distance vision in the center of the target image and press the MEMORY button ●.
- 2 Move the lens into the near vision region (bi-focal segment).
- 3 Press the MEMORY button ● and the bi-focal icon may appear on the bottom left side of the screen.
- 4 Measure the bi-focal power and press the MEMORY button ● again.

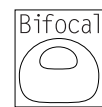
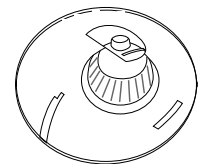
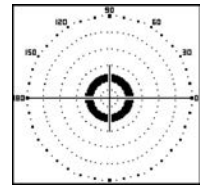

To measure the 2nd near vision of tri-focal lenses, storing the 1st mid vision power automatically changes the "MODE" button to the "ADD2" button. Pressing the "ADD2" button starts the near vision measurement. Pressing the Memory button will store the 2nd near vision.

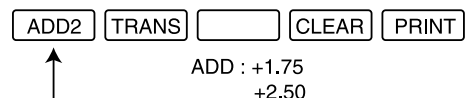

MEASURING AN UNPROCESSED PROGRESSIVE LENS

As each unprocessed lens has a mark on the measuring point. Do measurement on the mark position. For measurement, follow the procedure of “Measuring a progressive lens”, “measuring a progressive lens for distance vision” and “Measuring a progressive lens for near vision”.

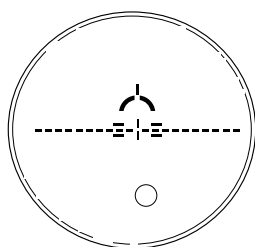

distance vision region marked

Near vision region marked



The measuring point for the distance or near vision region may be narrowed by marks. Take care that the luminous flux may not be shaded during measurement. ADD values will flicker when the luminous flux is shaded by marks or off the progressive zone at the time of measuring the near vision region. An EX lens may not be provided with accurate measurements when measured in the boundary.

MODE TO MEASURE THE DIOPTER POWER OF LENSES WITH THE CONCAVE SIDE UP

- 1** Set MENU/PROGRESSIVE/REVERSE.
- 2** Set the lens with the concave side down as usual, align the distance vision region, and press the MEMORY button ●.
- 3** Set the lens with the concave side up, align the distance vision region, and press the MEMORY button ●.
- 4** Leaving the lens with the concave side up, align the near vision region and press the MEMORY button ●.

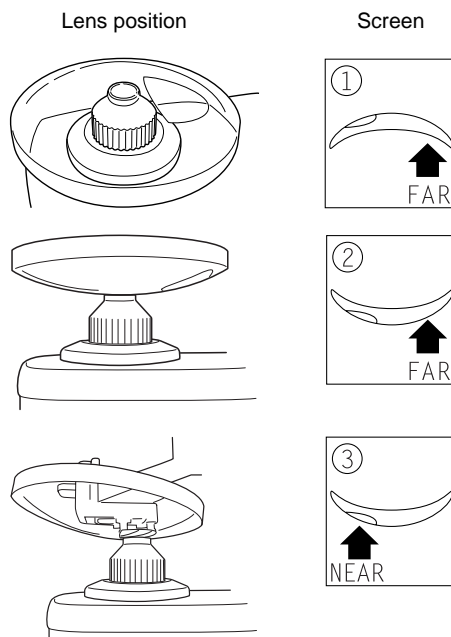

MEASURING A CONTACT LENS

- Measuring a hard contact lens

1 Replace the lens support with the contact lens support.

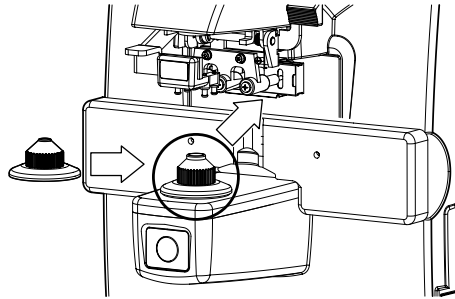

2 Select **MENU/LENS/HARD CONTACT** from the menu, and HARD.C will be displayed on the screen.

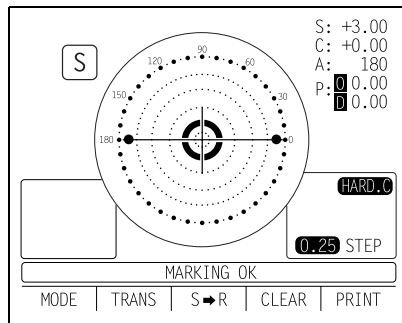

3 Put the contact lens on contact lens support with special tweezers.

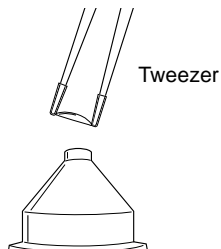

- Measuring a soft contact lens without astigmatism



A soft contact lens cannot be accurately measured because of its structure. Although you can measure a soft contact lens power in following way, consider the results an average and not the exact value.

- 1 Use the contact lens support for measuring as measuring a hard contact lens.
- 2 Select **MENU/LENS/SOFT CONTACT** and SOFT.C will be displayed on the screen.

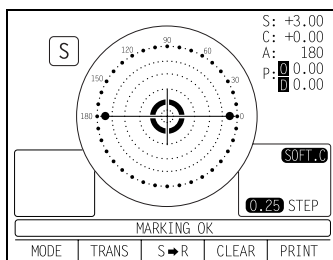

- 3 Pinch the soft contact lens with special tweezers to remove moisture from the lens. Put the lens between paper and move three times to remove moisture from the surface.

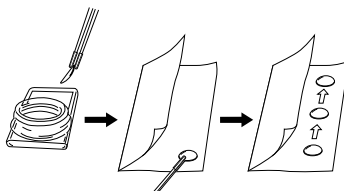

If there is moisture on the soft contact lens surface, it is not possible to measure because the luminous flux malfunctions.

- 4 If there is moisture dew on the surface when the contact lens is held to the light, put the lens in the special solution again, and repeat the above. Moreover, take care about turning inside out. When in the normal position, the lens looks like a bowl. However, when the lens turns inside out, the rim looks warped. If the lens is ready for measurement, place it on the contact lens holder and observe the shape (with tweezers) for alignment. After 30 seconds or more, the lens power changes since the internal moisture evaporates, therefore, measure it as quickly as possible.

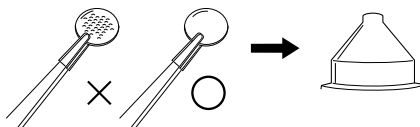

Use the hard contact mode when measuring a toric soft contact lens.

A:STEP MODE

Select **MENU/A:STEP/5** and press MODE button:

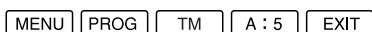

Press **A:5**.

The axial angle is rounded to 5°. The unit's place blinks.

It is convenient for inputting the result by doing measurement with the trial lens left in the temporary frame.

To reset, press **A:1** below:

MENU **PROG** **TM** **A:1** **EXIT**

The 5° rounding is reset.

AXIS MARKING

(CARTRIDGE SPECIFICATION/STEEL NEEDLE SPECIFICATION)

Using the cartridge, one light touch to the lens can put a clear ink mark.

MARKING A LENS WITHOUT ASTIGMATISM

- 1** Move the lens until the centering mark coincides with the target image completely, and MARKING OK will appear.

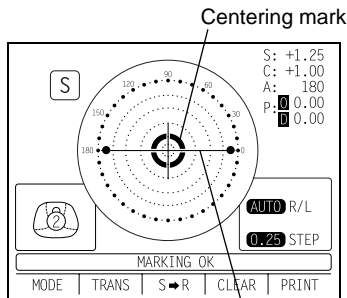

Line extends laterally to the target.

- 2** Depress the marking lever to mark the lens.

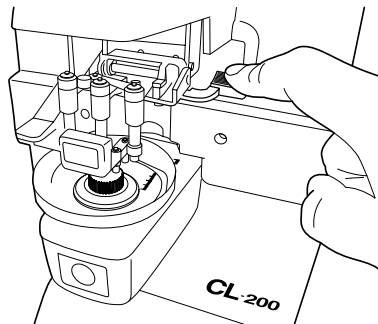

MARKING A LENS WITH ASTIGMATISM

- 1** Axis marking, maintaining the axis as prescribed
Align the target image with the center mark, approximating the axis angle mark to the angle as prescribed.



Do it with AUTO MEMORY OFF to prevent memorizing before axis alignment is finished.

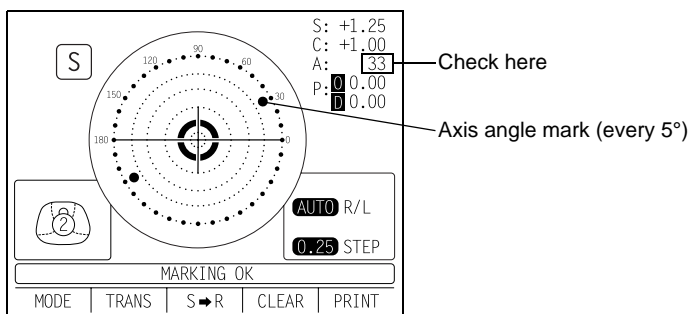

2 Marking a cylindrical axis

Match the center mark with the target image, approximating the axis angle mark to 180 degrees.

Adjust A of the axis angle to 180 degrees.

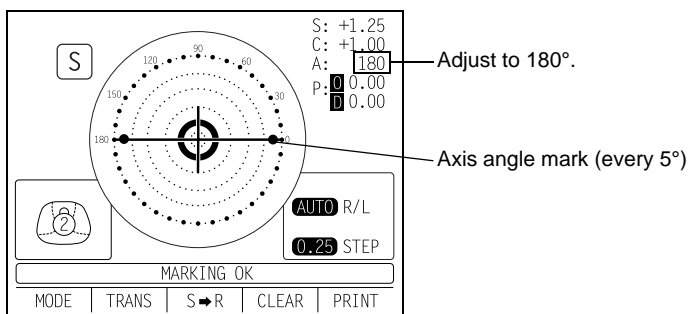

MARKING A LENS WITH PRISM POWER

- When the prescription is displayed with X-Y (orthogonal coordinates):

Select **MENU/PRISM/X-Y**.

Carry out aligning according to the prism value as prescribed and as displayed on the screen.

- in prism value: Base In
- in prism value: Base Out
- in prism value: Base Up
- in prism value: Base Down

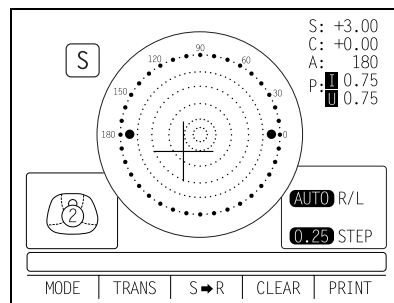

- When the prescription is displayed with P-B (polar coordinates)

Select **MENU/PRISM/P-B**.

Carry out aligning according to the prism value as prescribed and as displayed on the screen.

- P: Prism value
- B: Base orientation

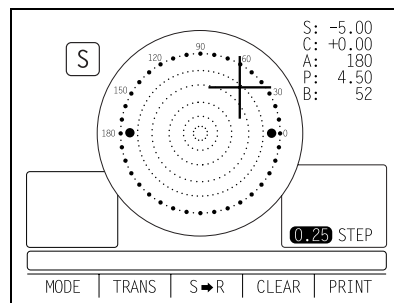



Take care that the polar coordinates are not the same as the value on the angular scale in the target image.

- When the unit is mm.

Select **MENU/PRISM/mm**.

The \uparrow \downarrow \leftarrow \rightarrow marks show the optical center reaches the center of measurement by moving the lens in the arrow directions by the distance as displayed.

\rightarrow 3.0mm

\downarrow 2.0mm

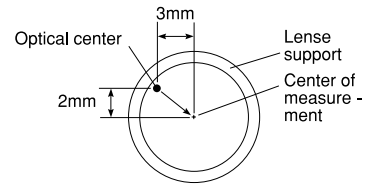





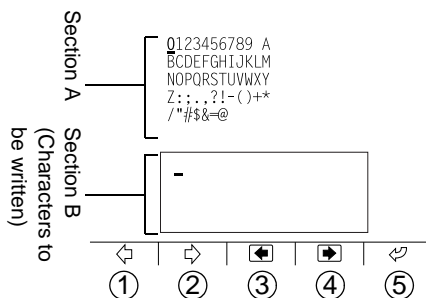

0 will be displayed if the spherical power S is around 0.

PRINTING ADDITIONAL TEXTBOX (WITH PRINTER SPECIFICATION)

On the print out with the measuring data, the user can input his own text, like office name, address or special message. The available space is three line of 20 characters each.

Select **MENU/NAME/SET** and press the button below the icon , and the world of marking of text will appear (as shown at below).



- ① : Moves to the left the cursor in Section A.
- ② : Moves to the right the cursor in Section A.
- ③ : Moves to the left where to write in Section B.
- ④ : Moves to the right where to write in Section B.
- ⑤ : Writes the character in Section B.

Upon completing Section B, move the cursor to END of Section A and press , and writing may be possible, returning the measurement screen. Once the characters are written, they will remain even after the instrument power is turned off.

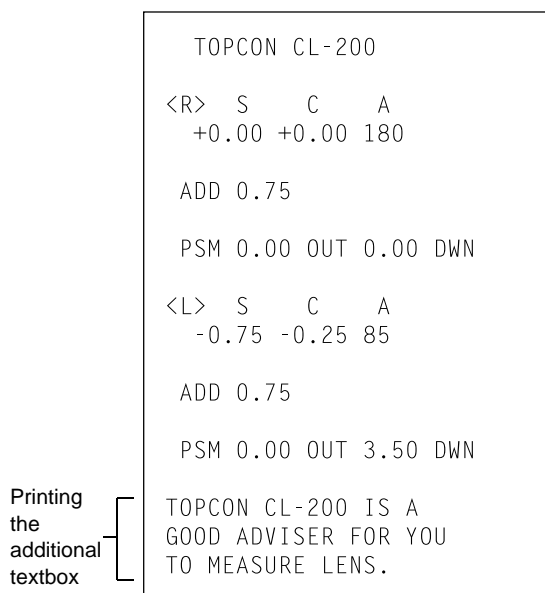

Printout





SETTING A SEQUENCE NO.



Setting is carried out when writing a sequence No. on printing paper and transferring the serial No., using RS-232C.

Select **MENU/SEQ.NO./SET** and press , and the screen as shown below will appear.

 and  are used to change the cursor figure.

 and  are used to change the cursor position.

Bring the cursor to END and press  to finish setting.

No printing or counting is carried out in case of 0000. Press MEMORY button , PRINT and CLEAR buttons in this order. and counting will be carried out. (except for  single lens).

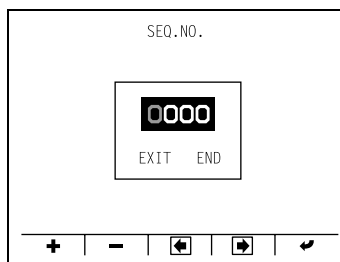

ABBE COMPENSATION FUNCTION

WHEN THE ABBE NUMBER OF LENS IS KNOWN:(AT SEVERAL DESTINATION : d-LINE SETTING)

In the menu screen ABBE, select any of the following according to the Abbe number of target lens:

Normal (50-60)

MID (40-50)

LOW (30-40)

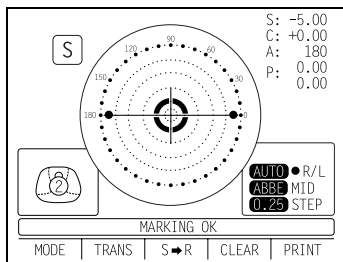

LENS PROTECTION PAD

The attached lens protection pad allows a soft contact with the measuring lens.

- 1** Fit the lens protection pad according to the instructions.
- 2** Select **MENU/LENS/NORMAL(PAD)**, and the measurement result will be automatically compensated.

COMPARTMENT SPACE

A space for keeping the contact lens holder, printer paper, etc. is secured in the back.

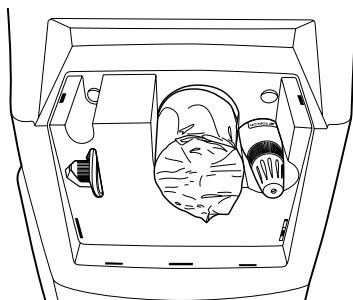

MEASURING PD (PD FITTING)(WITH PD SPECIFICATION)

- 1 Select **MENU/PD/ON**.
- 2 Put the spectacle frame onto the nose rest.

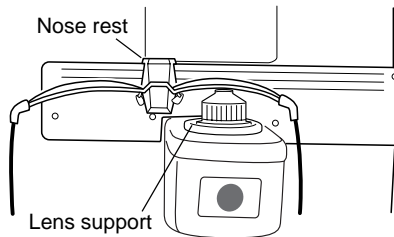

- 3 Align the lens until marking is OK. OK if the spectacle frame is horizontal along the lens table line. If the spectacle frame has a camber, align it horizontally.

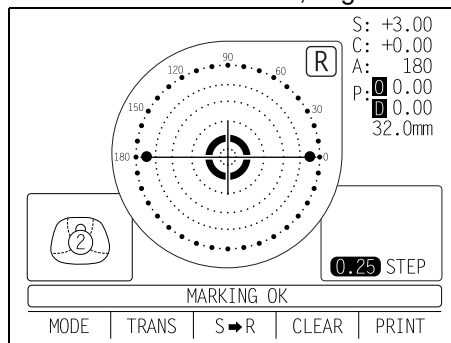

Errors will appear when the spectacle frame is not horizontally aligned.

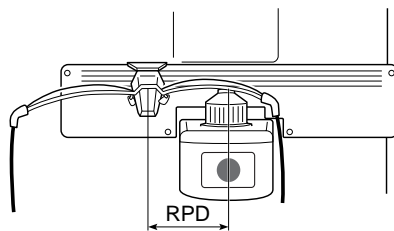

- 4 Press the lens retainer since the lens is in contact with the lens support sideways. Let your hand go with the spectacle frame to prevent PD value shifting.

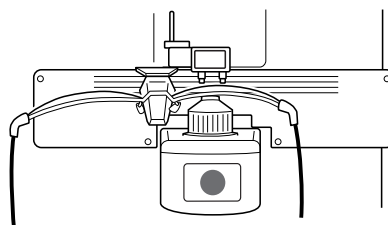

- 5 Press Memory button.

- 6** Follow the similar steps to measure the lens on the opposite side.
Totalled PD will be displayed.

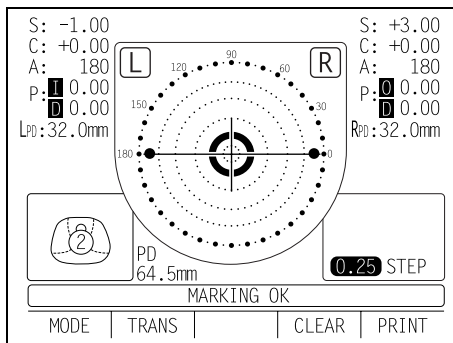

- 7** Bring the nose rest to the extreme right and fold it. It will stick to the lens table by means of a magnet.
Range 25 — 45mm on one side (minimum 0.5mm)

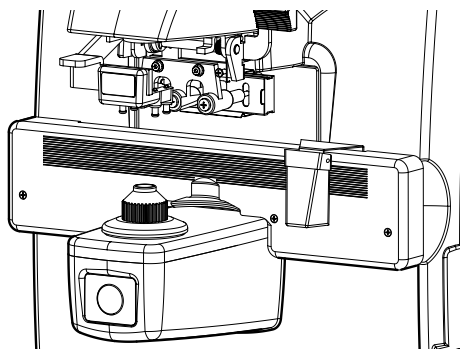

If the measured PD value differs from that of marking PD.

- 8** Difference may occur by the measurement technique and with low-power lenses having a large camber angle.

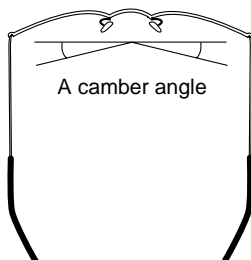
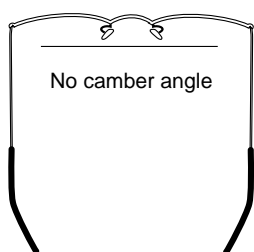

Since the optical center of the glasses mounted for the infinite far is searched, the measured PD value of CL-200 is called the PD/fitting value.

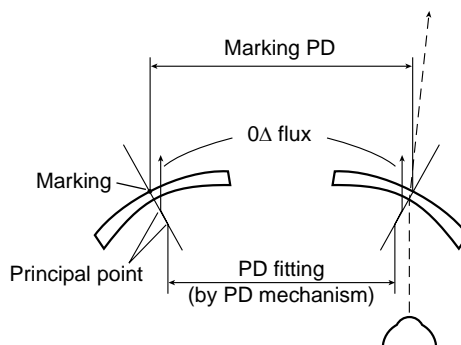

When the pupil is on the marking position in the case of a concave lens, a prism is added outside.

MAINTENANCE

AUTO SHUT-OFF

- 1** The monitor screen will shut off automatically if not in use for about 10 minutes.
- 2** Press any button to resume.
- 3** Select **MENU/AUTO OFF/NO** if it is not desirable.
Press the button ● for 3 sec and longer, and the monitor screen goes OFF.

FUSE

| | |
|--|--|
|  WARNING | To prevent electrical shock, turn off the power switch and disconnect power cable before replacing fuses. Replace fuses with the same rating and type. |
|--|--|

- 1** The fuse holder is provided at the bottom of the instrument.
- 2** Disconnect the power cable.
- 3** The cap of fuse holder comes off when screwdriver turns the cap.
- 4** A glass tube fuse is provided in the holder.

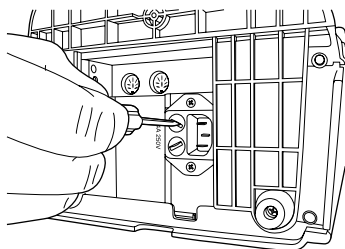

Fuse T 4A 250V: 100-240V

REPLACING THE MARKING INK CARTRIDGE (THE SAME APPLIES TO STEEL NEEDLE SPECIFICATION)

- 1** To replace the marking ink cartridge, remove the top screw. Pull out the cartridge while applying pressure to it so as the spring not jump out from the inside. Work the lens holder/stopper under the lowered condition.

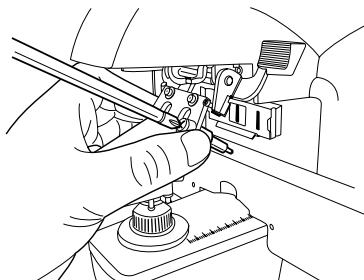

- 2** To set the cartridge, insert the spring and keep the cartridge top well above the marking ink holder, and then fasten the screw.

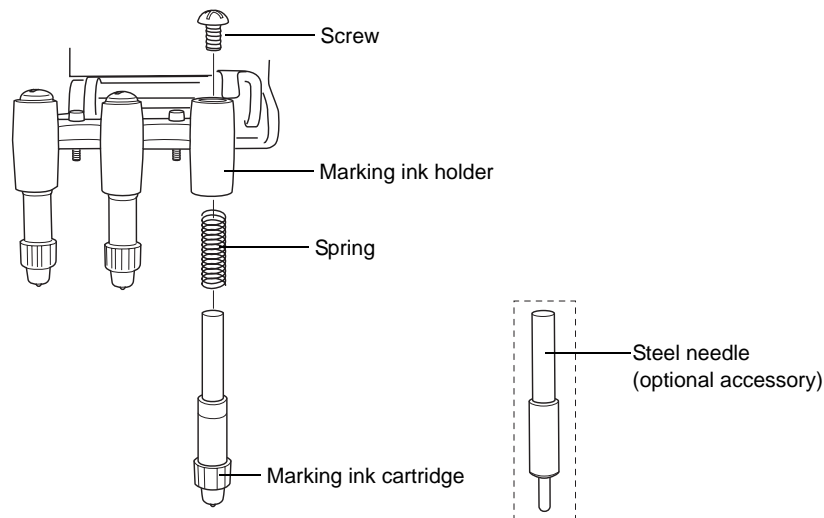

SUPPLY OF INK FOR THE OPTIONAL STEEL NEEDLE

- 1** Replenish ink when poor marking happens.
- 2** Slide laterally and pull out the inkpot.
- 3** Slide off cover from the inkpot.
- 4** Infiltrate supply ink into the sponge well.

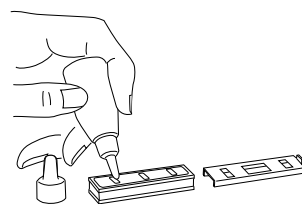

CLEANING COVER GLASSES

If the glass is dirty as indicated by arrows, it will affect measurement accuracy adversely. If this occurs, clean them with the attached silicon cloth.

Remove the lens support before cleaning the cover glass.

If the mark illustrated right appears at the lower part on the screen, it means that the cover glass is dirty.

Carry out the following operation;

- 1** Wipe off the cover glass for cleaning.
- 2** Press CLEAR and TRANS buttons simultaneously and the instrument will restart. If the measurement screen appears, continue the operation.

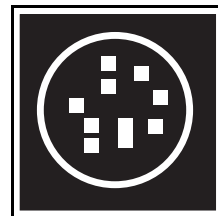
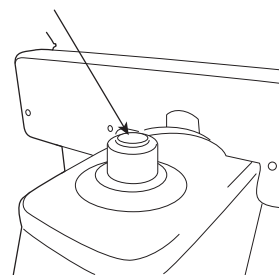

CLEANING THE INSTRUMENT

- 1** Wipe cover with silicone or damp cloth at regular interval. Never use cleanser or other chemicals.

BEFORE REQUESTING SERVICE

CAUTION MESSAGES

| | |
|--|---|
| <p>CLEAN THE COVER GLASS</p>  | <p>Carry out cleaning of the cover glass. Refer to the instruction at page 34.</p> |
| <p>DIOPTRER OVER PRISM OVER' ERROR</p> | <p>Check to see that the lens is in the measurable scope. Check to see that the lens is free from any flaw, dust or oil. Clean both glasses and turn power on again. Check the lens value is not beyond the unit's measuring range.</p> |
| <p>INITIAL ERROR</p> | <p>Request repair service. Remove the lens from the lens support, and turn on power again.</p> |
| <p>PAPER END (with printer specification)</p> | <p>Printer paper is out. Load new paper.</p> |
| <p>CLOSE PRINTER COVER (with printer specification)</p> | <p>Close printer cover. Refer to the instruction at page 16.</p> |

CHECK ITEMS

| | |
|---|--|
| <p>The instrument does not get ready for operation even if the power switch is turned on.</p> | <p>Re-plug the power cord. Give a check to the fuse.</p> |
| <p>The monitor screen can not be clearly seen.</p> | <p>Adjust the BRIGHT control dial.</p> |
| <p>S, C values are wrong.</p> | <p>Is the lens place with power on? Remove the lens and turn on power again. Is the measuring beam blocked by, dust, marks, grease, etc. in the measured lens?</p> |
| <p>Marking is poor.</p> | <p>Replace the marking ink cartridge. For a lens with sharp surface curve, use the optional steel needle marking set.</p> |
| <p>The screen went out all of a sudden.</p> | <p>The auto shut-off function is on. Press the MEMORY button ●, and the instrument will resume.</p> |
| <p>Pushed the Print button but the printer does not work. (with-printer type)</p> | <p>Is printer paper set properly? Not inside out?</p> |

SPECIFICATIONS

SPECIFICATIONS

| | |
|------------------------|---|
| Measurable scope | S: 0~+-25D, C: 0~+-10D, ADD: 0~+10D (0.01/0.12/0.25) P: 0~10 Δ (0.01/0.12/0.25), A: 1~180° (1°) |
| Cylinder mode | MIX/-/+ |
| Prism mode | No display / X-Y (Rectangular coordinates) / P-B (polar coordinates) / mm |
| Contact lens | Contact lenses are measurable. |
| Progressive focal lens | Single focal/progressive lens recognition, distance vision detection, ADD power bar-meter display |
| Compensating | e-line: Setting is no necessary d-line: Compensation of a lens different in Abbe number. |
| Display screen | Color LCD 320X240 dots S, C, A, P, ADD, ADD R/L display Enlarged SCA display. |
| Frame | Auto R/L function |
| Menu screen | Easy-to-watch screen with icon display |
| Lens diameter | ø5-100mm |
| Power supply | 100-240V 50VA (Auto shut-off in 10 minutes) |
| Dimensions, weight | 200 (W)X220 (D)X410 (H) 4kg approx. |

* Subject to changes in design and/or specifications, without advanced notice.

WITH PRINTER SPECIFICATION

Printer : Thermal printer, paper width 58mm

ELECTROMAGNETIC COMPATIBILITY

This product conforms to the EMC Standard (IEC 60601-1-2:2001).

- a) MEDICAL ELECTRICAL EQUIPMENT needs special precautions regarding EMC and needs to be installed and put into service according to the EMC information provided in the ACCOMPANYING DOCUMENTS.
- b) Portable and mobile RF communications equipment can affect MEDICAL ELECTRICAL EQUIPMENT.
- c) The use of ACCESSORIES, transducers and cables other than those specified, with the exception of transducers and cables sold by the manufacturer of the EQUIPMENT or SYSTEM as replacement parts for internal components, may result in increased EMISSIONS or decreased IMMUNITY of the EQUIPMENT or SYSTEM.
- d) The EQUIPMENT or SYSTEM should not be used adjacent to or stacked with other equipment. IF adjacent or stacked use is necessary, the EQUIPMENT or SYSTEM should be observed to verify normal operation in the configuration in which it will be used.
- e) The use of the ACCESSORY, transducer or cable with EQUIPMENT and SYSTEMS other than those specified may result in increased EMISSION or decreased IMMUNITY of the EQUIPMENT or SYSTEM.

| Item | Article code | Model No. | Length(m) |
|------------------------------|--------------|-----------|-----------|
| RS-232C on-line cable | 418120002 | - | 4.8 |
| USB CABLE (USB 2.0 Shielded) | - | - | 1.7 |

| Guidance and manufacturer's declaration - electromagnetic emissions | | |
|---|-------------------|--|
| The CL-200 is intended for use in the electromagnetic environment specified below. The customer or the user of the CL-200 should assure that it is used in such an environment. | | |
| Emissions test | Compliance | Electromagnetic environment - guidance |
| RF emissions CISPR 11 | Group 1 | The CL-200 uses RF energy only for its internal function. Therefore, its RF emissions are very low and are not likely to cause any interference in nearby electronic equipment. |
| RF emissions CISPR 11 | Class A | The CL-200 is suitable for use in all establishments other than domestic and those directly connected to the public low-voltage power supply network that supplies buildings used for domestic purposes. |
| Harmonic emissions IEC61000-3-2 | Class A | |
| Voltage fluctuations/ flicker emissions IEC61000-3-3 | Complies | |

Guidance and manufacturer's declaration - electromagnetic immunity

The CL-200 is intended for use in the electromagnetic environment specified below.
The customer or the user of the CL-200 should assure that it is used in such an environment.

| Immunity test | IEC 60601 test level | Compliance level | Electromagnetic environment - guidance |
|--|--|--|--|
| Electrostatic discharge (ESD) IEC 61000-4-2 | ±6 kV contact ±8 kV air | ±6 kV contact ±8 kV air | Floors should be wood, concrete or ceramic tile. If floors are covered with synthetic material, the relative humidity should be at least 30%. |
| Electrical fast transient/burst IEC 61000-4-4 | ±2 kV for power supply lines ±1 kV for input/output lines | ±2 kV for power supply lines ±1 kV for input/output lines | Mains power quality should be that of a typical commercial or hospital environment. |
| Surge IEC 61000-4-5 | ±1 kV differential mode ±2 kV common mode | ±1 kV differential mode ±2 kV common mode | Mains power quality should be that of a typical commercial or hospital environment. |
| Voltage dips, short interruptions and Voltage variations on power supply input lines IEC 61000-4-11 | <5% U_t (>95% dip in U_t) for 0.5 cycle 40% U_t (60% dip in U_t) for 5 cycles 70% U_t (30% dip in U_t) for 25 cycles <5% U_t (>95% dip in U_t) for 5 sec. | <5% U_t (>95% dip in U_t) for 0.5 cycle 40% U_t (60% dip in U_t) for 5 cycles 70% U_t (30% dip in U_t) for 25 cycles <5% U_t (>95% dip in U_t) for 5 sec. | Mains power quality should be that of a typical commercial or hospital environment. If the user or the CL-200 requires continued operation during power mains interruptions, it is recommended that the CL-200 be powered from an uninterruptible power supply or battery. |
| Power frequency (50/60 Hz) magnetic field IEC 61000-4-8 | 3 A/m | 3 A/m | Power frequency magnetic fields should be at levels characteristic of a typical location in a typical commercial or hospital environment. |

NOTE U_t is the a.c. mains voltage prior to application of the test level.

Guidance and manufacturer's declaration - electromagnetic immunity

The CL-200 is intended for use in the electromagnetic environment specified below.
The customer or the user of the CL-200 should assure that it is used in such an environment.

| Immunity test | IEC 60601 test level | Compliance level | Electromagnetic environment-guidance |
|--|--|-------------------------|---|
| <p>Conducted RF IEC 61000-4-6</p> <p>Radiated RF IEC 61000-4-3</p> | <p>3 Vrms 150kHz to 80MHz</p> <p>3 V/m 80MHz to 2.5GHz</p> | <p>3 V</p> <p>3 V/m</p> | <p>Portable and mobile RF communications equipment should be used no closer to any part of the CL-200, including cables, than the recommended separation distance calculated from the equation applicable to the frequency of the transmitter.</p> <p>Recommended separation distance</p> $d = 1.2\sqrt{P}$ <p>$d = 1.2\sqrt{P}$ 80MHz to 800MHz</p> <p>$d = 2.3\sqrt{P}$ 800MHz to 2.5GHz</p> <p>where P is the maximum output power rating of the transmitter in watts (W) according to the transmitter manufacturer and d is the recommended separation distance in meters (m).</p> <p>Field strengths from fixed RF transmitters, as determined by an electromagnetic site survey,^a should be less than the compliance level in each frequency range.^b</p> <p>Interference may occur in the vicinity of equipment marked with the following symbol:</p> <div style="text-align: center;">  </div> |

NOTE 1 At 80 MHz and 800 MHz, the higher frequency range applies.

NOTE 2 These guidelines may not apply in all situations. Electromagnetic propagation is affected by absorption and reflection from structures, objects and people.

^a Field strengths from fixed transmitters, such as base stations for radio (cellular/cordless) telephones and land mobile radios, amateur radio, AM and FM radio broadcast and TV broadcast cannot be predicted theoretically with accuracy. To assess the electromagnetic environment due to fixed RF transmitters, an electromagnetic site survey should be considered. If the measured field strength in the location in which the CL-200 is used exceeds the applicable RF compliance level above, the CL-200 should be observed to verify normal operation. If abnormal performance is observed, additional measures may be necessary, such as reorienting or relocating the CL-200.

^b Over the frequency range 150 kHz to 80 MHz, field strengths should be less than 3 V/m.

Recommended separation distance between portable and mobile RF communications equipment and the CL-200

The CL-200 is intended for use in an electromagnetic environment in which radiated RF disturbances are controlled. The customer or the user of the CL-200 can help prevent electromagnetic interference by maintaining a minimum distance between portable and mobile RF communications equipment (transmitters) and the CL-200 as recommended below, according to the maximum output power of the communications equipment.

| Rated maximum output power of transmitter W | Separation distance according to frequency of transmitter m | | |
|--|--|--------------------------------------|---------------------------------------|
| | 150kHz to 80MHz $d = 1.2\sqrt{P}$ | 80MHz to 800MHz $d = 1.2\sqrt{P}$ | 800MHz to 2.5GHz $d = 2.3\sqrt{P}$ |
| 0.01 | 0.12 | 0.12 | 0.23 |
| 0.1 | 0.38 | 0.38 | 0.73 |
| 1 | 1.2 | 1.2 | 2.3 |
| 10 | 3.8 | 3.8 | 7.3 |
| 100 | 12 | 12 | 23 |

For transmitters rated at a maximum output power not listed above, the recommended separation distance d in metres (m) can be estimated using the equation applicable to the frequency of the transmitter, where P is the maximum output power rating of the transmitter in watts (W) according to the transmitter manufacturer.

NOTE 1 At 80 MHz and 800 MHz, the separation distance for the higher frequency range applies.

NOTE 2 These guidelines may not apply in all situations. Electromagnetic propagation is affected by absorption and reflection from structures, objects and people.

SYSTEM CLASSIFICATION

- Type of protection against electric shocks: Class I equipment
Class I equipment does not depend on basic insulation only for protection against electric shocks. It can also be earthed; therefore, the metal parts with which one comes into contact do not become conductive if the basic insulation fails.
- Degree of protection against harmful ingress of water: IPx0
CL-200 has no protection against ingress of water. (The degree of protection against harmful ingress of water defined in IEC 60529 is IPx0)
- Classification according to the method(s) of sterilization or disinfection recommended by the manufacturer: not applicable.
- Classification according to the degree of safety of application in the presence of a flammable anaesthetic mixture with air or with oxygen or nitrous oxide: Equipment not suitable for use in the presence of a flammable anaesthetic mixture with air or with oxygen or nitrous oxide. CL-200 should be used in environments where no flammable anesthetics and/or flammable gases are presents.
- Classification according to the mode of operation: Continuous operation.
Continuous operation is the operation under normal load for an unlimited period, without the specified limits of temperature being exceeded.

OPTIONAL ACCESSORIES

Steel needle marking set (steel needle, supply ink, inkpot, holder)





ORDERING CONSUMABLE SUPPLIES AND SPARES

| | Product name | Part code No. | Remark |
|-------------|--|---------------|----------------------------|
| Spare part | Fuse T 4A 250V:100-240V | 42038 9004 | Standard accessory |
| Consumables | Marking ink cartridge (3 cartridges/set) | 42036 9950 | Standard accessory |
| | Lens protection pad | 42036 5800 | Standard accessory |
| | Steel needle marking set | 42036 2510 | Optional accessory |
| | Supply ink | 42036 9006 | Optional accessory |
| | Printer paper | 44800 4001 | With printer specification |

SHAPE OF PLUG

| Country | Voltage/frequency | Shape of plug |
|--------------------|--------------------------|---|
| Mexico | 110V/50Hz | Type C&E |
| Argentina | 220V/60Hz | Type A |
| Peru | 220V/60Hz | Type A |
| Venezuela | 110V/50Hz | Type C&E |
| Bolivia & Paraguay | 220V/60Hz | Type A (Most common) Type H (infrequently) |
| Chile | 220V/60Hz | Type A |
| Colombia | 110V/50Hz | Type C |
| Brazil | 220V/60Hz 127V/60Hz | Type A Type C |
| Ecuador | 110V/50Hz | Type C&E |
| USA | 120V/60Hz | Type A (Hospital Grade) |
| Canada | 120V/60Hz | Type A (Hospital Grade) |

SYMBOL

| Symbol | IEC Publication | Description | Description (French) |
|---|------------------------|---|---|
|  | 60417-5032 | Alternating Current | Courant alternatif |
|  | 60348 | Attention, consult accompanying documents | Attention, consulter les documents d'accompagnement |
|  | 60417-5008 | Off (power: disconnection from the mains) | Éteint (courant: coupure avec le secteur) |
|  | 60417-5007 | On (power: connection of the mains) | Allumé (courant: raccordement sur le secteur) |

USING THE INSTRUMENT AS A SYSTEM

ON - LINE SYSTEM

The data of computerized lensmeter can be transferred to the instruments through RS-232C interface, and also measuring data of the instruments can be transferred to computerized visiontester.

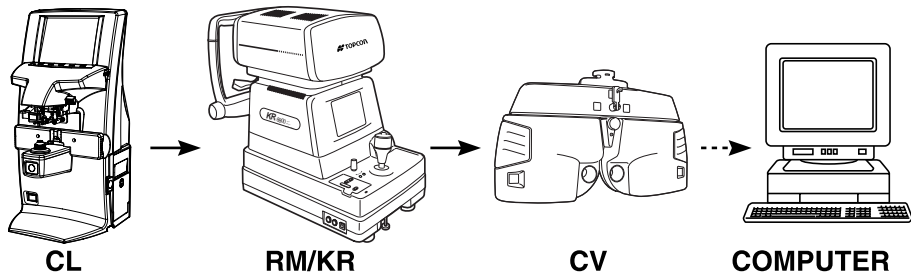

USB

Driver software for receiving of the PC side is under development. For transfer of data using USB, please ask your TOPCON dealer.

When calling please give us the following information about your unit:

- Machine type: CL-200
- Manufacturing No. (Shown on the rating plate on the back of the instrument)
- Period of Usage (Please give us the date of purchase).
- Description of Problem (as detailed as possible).

COMPUTERIZED LENSMETER CL-200

INSTRUCTION MANUAL

Version of 2006 (2006.04-500LW1)

Date of issue: 1th, April, 2006

Published by TOPCON CORPORATION

75-1 Hasunuma-cho, Itabashi-ku, Tokyo, 174-8580 Japan.

CL-200

TOPCON MEDICAL SYSTEMS, INC.

37 West Century Road, Paramus, New Jersey 07652, U.S.A. Phone: 201-261-9450 Fax: 201-387-2710 www.topcon.com

TOPCON CANADA INC.

110 Provencher Avenue, Boisbriand, QC J7G 1N1 CANADA Phone: 450-430-7771 Fax: 450-430-6457 www.topcon.ca

TOPCON EUROPE B.V.

(European Representative)
Essebaan 11, 2908 LJ Capelle a/d IJssel, THE NETHERLANDS Phone: 010-4585077 Fax: 010-4585045 www.topconeurope.com

TOPCON EUROPE MEDICAL B.V.

(European Sole Sales Company)
Essebaan 11, 2908 LJ Capelle a/d IJssel, THE NETHERLANDS Phone: 010-4585077 Fax: 010-2844940 www.topconeurope.com

ITALY OFFICE: Via Dell' Industria n.60, 20037 Paderno Dugnano, (Milano), ITALY Phone: 02-61-25-583 E-mail: info.topconitaly@tiscali.it www.topcon.it

TOPCON DEUTSCHLAND G.m.b.H.

Giesserallee 31-33 D-47877 Willich GERMANY Phone: 02154-8850 Fax: 02154-885111 www.topcon.de Med@topcon.de

TOPCON ESPAÑA S.A.

HEAD OFFICE: Frederic Mompou 5, ED. Euro 3, 08960, Sant Just Desvern Barcelona, SPAIN Phone: 93-4734057 Fax: 93-4733932 www.topconesp.com
MADRID OFFICE: Avenida Burgos, 16E, 1° 28036, Madrid, SPAIN Phone: 91-302-4129 Fax: 91-383-3890

TOPCON S.A.R.L.

89, rue de Paris 92585 Clichy, Cedex, FRANCE Phone: 01-4106-9494 Fax: 01-4739-0251

TOPCON SCANDINAVIA A.B.

Neogatan 2 S-43151 Molndal, SWEDEN Phone: 031-7109200 Fax: 031-7109249 info@topcon.se

TOPCON (GREAT BRITAIN) LTD.

Topcon House, Kennet Side, Bone Lane, Newbury, Berkshire RG14 5PX United Kingdom Phone: 01635-551120 Fax: 01635-551170

TOPCON SOUTH ASIA PTE.LTD.

Blk 192 Pandan Loop, #07-01 Pantech Industrial Complex, SINGAPORE 128381 Phone: 62780222 Fax: 62733540 www.topcon.com.sg

TOPCON INSTRUMENTS (MALAYSIA) SDN.BHD.

Excella Business Park Block C, 1st Floor, Jalan Ampang Putra, Taman Ampang Hillir, 55100 Kuala Lumpur, MALAYSIA Phone: 03-42701192 Fax: 03-42704508

TOPCON INSTRUMENTS (THAILAND) CO.,LTD.

77/162 Sinn Sathorn Tower, 37th Fl., Krungdhonburi Rd., Klontongsai, Klongsarn, Bangkok 10600, THAILAND Phone: 440-1152~7 Fax: 440-1158

TOPCON AUSTRALIA PTY.LTD.

Unit 18, 4 Avenue of Americas Newington NSW 2127 AUSTRALIA Phone: 02-8748-8777 Fax: 02-9647-2926 www.topcon.com.au

TOPCON KOREA CORPORATION

2F Yooseoung Bldg., 1595-3, Seocho-Dong, Seocho-Gu, Seoul, 137-876 KOREA Phone: 02-2055-0321 Fax: 02-2055-0319 www.topcon.co.kr

TOPCON OPTICAL (H.K.) LTD.

2/F., Meeco Industrial Bldg., No.53-55 Au Pui Wan Street, Fo Tan Road, Shatin, N.T., Hong Kong Phone: 2690-1328 Fax: 2690-2221 E-mail: sales@topcon.com.hk

TOPCON CORPORATION BEIJING OFFICE

1070 Poly Plaza Building, 14 Dongzhimen Nandajie Dongcheng District, Beijing, 100027, CHINA Phone: 10-6501-4191 Fax: 10-6501-4190

TOPCON CORPORATION BEIRUT OFFICE

P.O.Box 70-1002 Antelias, BEIRUT-LEBANON Phone: 961-4-523525/523526 Fax: 961-4-521119

TOPCON CORPORATION DUBAI OFFICE

C/O Atlas Medical FZCO., P.O.Box 54304, C-25, Dubai Airport Free Zone, UAE Phone: 971-4-2995900 Fax: 971-4-2995901

TOPCON CORPORATION

75-1 Hasunuma-cho, Itabashi-ku, Tokyo, 174-8580 Japan.

Phone: 3-3558-2520 Fax: 3-3960-4214 www.topcon.co.jp