

Parker Hydrogen Gas Generator

**Models H2PEMPD-510, H2PEMPD-650,
H2PEMPD-850, H2PEMPD-1100, H2PEMPD-1300**

Installation, Operation, and Maintenance Manual

Parker Balston

Technical Information Bulletin

Please note that all Parker gas generators have a warranty period of 1 year from the date of shipment



The H2PEMPD-1300 hydrogen generator, operating at full flow, will consume the entire water reservoir volume in approximately 60 hours.

If the user expects to run the generator, unattended, for greater than 60 hours then the auto water feed feature MUST BE used. See user's guide for details.

Failure to use auto water feed will result in loss of flow and pressure, and could result in damage to generator.

Warning! The Auto Water Feed deionized water supply needs to be regulated down to the maximum allowable inlet pressure of the H2PEMPD Hydrogen Generator of 1.45 psig (0.1 barg).

Warranty

This warranty applies to the generator and associated parts (the equipment) manufactured and supplied by Parker Hannifin Corporation, Gas Separation and Filtration Division (the company).

Use of the generator without the recommended water quality or genuine parts will expressly invalidate the warranty. Any modification of the generator will void the warranty.

It should be noted that the generator must be installed and running within three months of dispatch from the company to ensure the optimum efficiency of the PEM cell. If this is not adhered to the warranty will be invalid. Should the equipment be defective as to materials or workmanship, the company warrants that it will remedy such a defect. Where the equipment is the generator, the warranty period will be 12 months from date of manufacture. Where the equipment is the PEM CELL, the warranty period will be 36 months from date of manufacture. In the case of equipment other than the generator, the warranty period shall commence from the date of dispatch.

Should any defect occur during the warranty period and be notified in writing to the company or its authorized distributor within the said period, the company will, as its sole option, remedy such defect by repair or provision of a replacement part, provided that the equipment has been used strictly in accordance with the instructions provided with each item of equipment and has been stored, installed, commissioned, operated and maintained in accordance with such instruction and with good practice. The company shall not be under any liability whatsoever under the warranty, if, before giving notification in writing to the company as aforesaid, the Customer or any third party meddles, interferes, tampers with or carries out work whatsoever (apart from normal maintenance as specified in the said instructions) in relation to the equipment or any part thereof.

Any accessories, parts and equipment supplied by the company but not manufactured by the company shall carry whatever warranty the manufacturer has given the company providing it is possible for the company to pass on such warranty to the customer.

To claim under the warranty, the goods must have been installed and continually maintained in the manner specified in the User Guide. Our product support engineers are qualified and equipped to assist you in this respect. They are also available to make repairs that may become necessary in which event they will require an official order before carrying out the work. If such work is to be the subject of a warranty claim, the order should be endorsed for consideration under warranty.

Where equipment is sold outside the USA direct to the end user the warranty will cover parts only. Any substitution of parts not manufactured or approved by the company will expressly invalidate the warranty.

1 Safety Information	1
1.1 Markings and Symbols	2
2 Description	3
2.1 Technical Specification.....	3
2.2 Weight and Dimensions.....	4
2.3 Receiving and Inspecting the Equipment	4
2.3.1 Storage.....	4
2.3.2 Unpacking	5
2.3.3 Overview of the equipment	5
2.4 Locating the Equipment.....	5
2.4.1 Environment	6
2.4.2 Space Requirements.....	6
2.4.3 Ventilation Requirements	6
2.4.4 Water Supply Requirements	6
2.4.5 Electrical Supply Requirements	6
3 Installation & Setup.....	7
3.1 Recommended system layout	7
3.1.1 Installation Kit	7
3.2 Connecting the generator.....	8
3.2.1 Environmental filters.....	8
3.2.2 Hydrogen outlet port.....	8
3.2.3 Drain ports.....	8
3.2.4 Electrical supply	8
3.2.5 Filling the water bottle	9
3.2.6 Water supply (generators fitted with Auto Water Fill).....	9
3.3 Options Board Accessory	9
3.3.1 Fitting the Options Board.....	9
3.3.2 Wiring the Options Board	10
3.4 Starting up the Generator	11
4 Operating the equipment	12
4.1 Overview of controls	12
4.2 Starting the equipment	12
4.3 Operating Menus	13
4.3.1 Default Menu.....	13
4.3.2 Conductivity.....	14
4.3.3 Pressure Measurement.....	14
4.3.4 Run Time Data	14
4.3.5 Flow.....	15
4.3.6 Error Log	15
4.3.7 Generator Self-Test	15
4.4 Hard Reset.....	16
4.5 Stopping the equipment and depressurizing	16
5 Servicing.....	16
5.1 Cleaning	16
5.1.1 Service Intervals.....	17
5.2 Service Kits.....	18
5.2.1 Recommended Service A - Required every 4000Hrs (6 months)	18
5.2.2 Recommended Service B - Required every 16000Hrs (24 months)	18
5.3 Consumable Replacement Procedures.....	19
5.3.1 Draining the water bottle	19
5.3.2 Replacing the deionizer cartridge and 100 micron water filter	19
5.3.3 Replacing the Environmental Filters	19
5.3.4 Replacing the water pump.....	19
5.3.5 Replacing the fan guards.....	21
5.3.6 Filling the water bottle.....	21
6 Error Messages.....	20

1 Safety Information

Do not install and operate this equipment until the safety information and instructions in this user guide have been read and understood by all personnel concerned.

USER RESPONSIBILITY

FAILURE OR IMPROPER SELECTION OR IMPROPER USE OF THE PRODUCTS DESCRIBED HEREIN OR RELATED ITEMS CAN CAUSE DEATH, PERSONAL INJURY AND PROPERTY DAMAGE.

This document and other information from Parker Hannifin Corporation, its subsidiaries and authorized distributors provide product or system options for further investigation by users having technical expertise.

The user, through its own analysis and testing, is solely responsible for making the final selection of the system and components and assuring that all performance, endurance, maintenance, safety and warning requirements of the application are met. The user must analyze all aspects of the application, follow applicable industry standards, and follow the information concerning the product in the current product catalogue and in any other materials provided from Parker or its subsidiaries or authorized distributors.

To the extent that Parker or its subsidiaries or authorized distributors provide component or system options based upon data or specifications provided by the user, the user is responsible for determining that such data and specifications are suitable and sufficient for all applications and reasonably foreseeable uses of the components or systems.

Only competent personnel trained, qualified, and approved by Parker Hannifin should perform installation, start-up, service and repair procedures.

This equipment is for indoor use only. Do not operate outdoors.

This equipment is not suitable for use in any Hazardous, Flammable, or Explosive environments. Hydrogen is a highly flammable gas. Keep the generator away from excessive heat and naked flames.

With the exception of oxygen, any gas can cause asphyxiation in high enough concentrations. In most scenarios, however, because hydrogen rises and disperses so rapidly, it is unlikely to be confined where asphyxiation might otherwise occur. Always ensure that the generator is operated in a well-ventilated area and all of the vent ports on the rear of the generator are kept clear and free from blockages.

Use of the equipment in a manner not specified within this user guide may result in an unplanned release of pressure, which may cause serious personal injury or damage.

When handling, installing or operating this equipment, personnel must employ safe engineering practices and observe all related regulations, health & safety procedures, and legal requirements for safety.

Ensure that the equipment is depressurized and electrically isolated, prior to carrying out any of the scheduled maintenance instructions specified within this user guide.

Parker Hannifin cannot anticipate every possible circumstance which may represent a potential hazard. The warnings in this manual cover the most known potential hazards, but by definition cannot be all-inclusive. If the user employs an operating procedure, item of equipment or a method of working which is not specifically recommended by Parker Hannifin the user must ensure that the equipment will not be damaged or become hazardous to persons or property.

Most accidents that occur during the operation and maintenance of machinery are the result of failure to observe basic safety rules and procedures. Accidents can be avoided by recognizing that any machinery is potentially hazardous.

Note: Any interference with the calibration warning labels will invalidate the gas generator's warranty and may incur costs for the recalibration of the gas generator.

Should you require an extended warranty, tailored service contracts or training on this equipment, or any other equipment within the Parker Hannifin range, please contact your local Parker Hannifin office.

Details of your nearest Parker Hannifin sales office can be found at www.Labgasgenerators.com. **Retain this user guide for future reference.**

1.1 Markings and Symbols

The following markings and international symbols are used on the equipment or within this manual:













	Caution, Read the User manual.		Highlights actions or procedures which, if not performed correctly, could lead to electric shock.
	Risk of electric shock.		When disposing of old parts always follow local waste disposal regulations.
	Highlights actions or procedures which, if not performed correctly, may lead to personal injury or death.		Conformité Européenne
	Highlights actions or procedures which, if not performed correctly, may lead to damage to this product.		Waste electrical and electronic equipment should not be disposed of with municipal waste.
	Wear disposable gloves.		Do not expose to naked flame.
	DO NOT OBSTRUCT VENT PORTS LEAVE OPEN TO ATMOSPHERE OR PIPE TO VENTILATED AREA WARNING GENERATOR MUST BE SHUT DOWN AND DEPRESSURIZED BEFORE PERFORMING ANY MAINTENANCE (REFER TO USER GUIDE)		Canadian Standards Association certification

Table 1

2 Description





This generator will produce a constant stream of high purity hydrogen at a predetermined flow rate and pressure when connected to a suitable power supply and fed with a suitable quality of deionized water. It is suitable for use in laboratories and light industrial environments and is nonhazardous for transportation purposes.



In order to guarantee the optimum efficiency of the PEM cell, this generator must be installed and running within three months of dispatch from Parker Hannifin. Failure to do this may invalidate the warranty. The generator will perform a 60 minute (1 hour) initialization sequence when powered for the first time. This sequence, which cannot be aborted, is necessary to guarantee the correct hydration of the cell.

2.1 Technical Specification

This specification is valid when the equipment is located, installed, operated, and maintained as specified within this user guide.

		Units	H2PEMPD-510	H2PEMPD-650	H2PEMPD-850	H2PEMPD-1100	H2PEMPD-1300
Water							
Water Quality		Deionized, ASTM II, > 1MP, <1μS, Filtered to <100μm					
Consumption (Approximate) ¹		cc/week	4000	5000	7000	8000	9000
Supply Pressure (Max) ²		psi g (bar g)	1.45 (0.1)				
Supply Flow Rate (Max) ²		cc/min	1000				
Supply Temperature (Max) ²		°F (°C)	68 (20)				
High Purity Hydrogen (H₂)							
Outlet Flow Rate		ml/min.	510	650	850	1100	1300
Outlet Pressure	H2PEMPd-XXX-100	psi g (bar g)	5-100± 0.5 (0.3-6.89 ± 0.034)				
	H2PEMPd-XXX-175		5-175± 0.5 (0.3-12.06 ± 0.034)				
Purity ³		%	99.99999+%				
Mechanical Connections							
Hydrogen Outlet			1/4" Compression fitting				
Water Drain			Quick release push in fitting				
Automatic Water Fill Inlet (factory or field fit option)			Quick release push in fitting				
Overflow Drain			Quick release push in fitting				
Spillage Drain			1/2" Barbed push on fitting				
Electrical Data							
Power		VA	270	300	340	420	450
Connection Type		IEC320					
Supply Voltage Range/Frequency		100-240Vac 50/60Hz					
Fuse ⁴		A	5				
Environmental Data							
Ambient Temperature		°F (°C)	50-90 (10-32)				
Relative Humidity		-	50% @ 104F (40°C) (80% Max < 87.8°F (31°C))				
IP Rating		-	IP20, NEMA 1, Indoor use only				
Pollution Degree		-	2				
Installation Over Voltage Category		-	II				
Maximum Altitude		ft. (m)	<6562 (2000)				
Noise		dB(A)	<60				

1. Based on full flow with 24 hour 7 day operation at 22C (72°F) ambient temperature.

2. Applies to generators with auto water fill only.

3. The balance is less than 1 ppm O₂ and moisture.

4. Anti-surge (T), 250V, 5 x 20mm HBC, Breaking capacity 1500A @ 250V, IEC 60127, UL R/C Fuse.

Table 2

2.2 Weight and Dimensions

The dimensions and weight of the equipment are specified below.

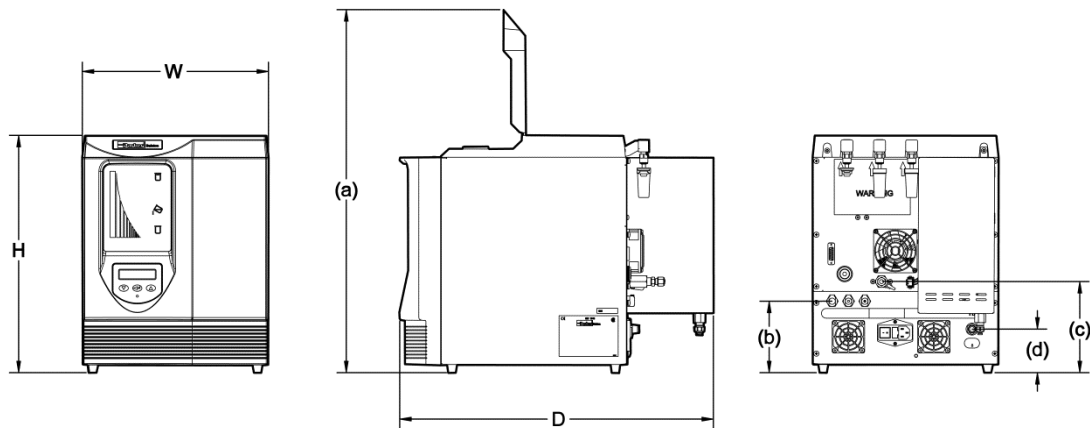

Figure 1

Dimension	Units	H2PEMPD-510	H2PEMPD-650	H2PEMPD-850	H2PEMPD-1100	H2PEMPD-1300
H	in (mm)	17.1 (435)	17.1 (435)	17.1 (435)	17.1 (435)	17.1 (435)
W	in (mm)	13.5 (342)	13.5 (342)	13.5 (342)	13.5 (342)	13.5 (342)
D	in (mm)	21 (533)	21 (533)	21 (533)	21 (533)	21 (533)
(a)	in (mm)	25.4 (645)	25.4 (645)	25.4 (645)	25.4 (645)	25.4 (645)
(b)	in (mm)	4.3 (108)	4.3 (108)	4.3 (108)	4.3 (108)	4.3 (108)
(c)	in (mm)	4.4 (11.5)	4.4 (11.5)	4.4 (11.5)	4.4 (11.5)	4.4 (11.5)
(d)	in (mm)	2.3 (59.5)	2.3 (59.5)	2.3 (59.5)	2.3 (59.5)	2.3 (59.5)
Weight						
Water bottle empty	lb (kg)	51.4 (23.4)	51.4 (23.4)	51.4 (23.4)	51.4 (23.4)	51.4 (23.4)
Water bottle full	lb (kg)	60.2 (27.4)	60.2 (27.4)	60.2 (27.4)	60.2 (27.4)	60.2 (27.4)

Table 3

2.2 Receiving and Inspecting the Equipment

On receipt of the equipment carefully inspect the packaging for damage. If the packaging is damaged inform the delivery company immediately and contact your local Parker Hannifin office.

2.3.1 Storage

If the equipment is to be stored prior to installation, do not remove it from the packaging. Ensure that it is stored in an upright position as indicated by the arrows on the packaging



Warning Do not attempt to lift the generator by yourself. It is recommended that the generator be carried by a minimum of two persons or transported on a pallet truck.

Note. The storage area should be secure and the environmental conditions should fall within those specified in the technical specification. If the generator is stored in an area where the environmental conditions fall outside of those specified, it is essential that it be moved to its final location (installation site) and left to stabilize prior to unpacking. Failure to do this could cause condensing humidity and potential failure of the generator.

2.3.2 Unpacking

Once ready to install, remove the equipment from the packaging and check for signs of damage. Verify that the following items have been included with the shipment:

Description	Qty
Water drain tube	1
Water fill tube ¹	1
Deionizer cartridge	1
Environmental filters	2
Electrical supply cable	5

1. Supplied only with generators fitted with the water fill option

Table 4

If any items are missing or damaged please contact your local Parker Hannifin office. Do not attempt to power up the generator.

2.3.3 Overview of the equipment

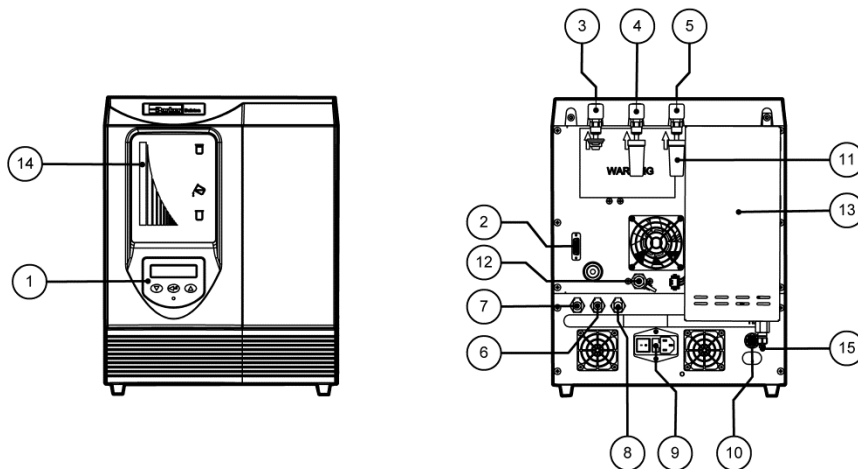

Figure 2

1	Control panel	8	Overflow drain
2	Options board connection port	9	Fused IEC 320 inlet socket and ON/OFF switch
3	O ₂ vent (<250ml/min)	10	Water bottle spillage drain
4	Excess H ₂ vent (<1 ml/min)	11	Environmental filter
5	Water bottle vent	12	Hydrogen outlet port valve
6	Water drain	13	Purifier
7	Auto water fill connection (factory or field fit option)	14	Water level
		15	H2 bleed outlet

Table 5

2.4 Locating the Equipment



This equipment is not suitable for use in any Hazardous, Flammable, or Explosive environments. Keep the generator away from excessive heat and open flames.

2.4.1 Environment

The equipment should be located indoors in an environment that protects it from direct sunlight, moisture, and dust. Changes in temperature, humidity, and airborne pollution will affect the environment in which the equipment is operating and consequently may impair the safety and operation.

It is the customers' responsibility to ensure that the environmental conditions specified in table 2 are maintained.

2.4.2 Space Requirements

The equipment should be mounted on a flat surface, capable of withstanding the weight of the equipment and all ancillary parts. A minimum clearance of 150mm (5.9in) should be provided on all sides of the generator for air flow. Additional space should be provided so that the generator can be moved to allow unrestricted access to the generator during servicing and maintenance.

Do Not block the side vents or the fans located on the rear panel of the generator.

When considering the vertical clearance you must take into account the height required when the front upper access panel is in the open position. Refer to table 3 for overall dimensions of the equipment.

Do Not position the equipment so that it is difficult to operate or disconnect from the electrical supply.

2.4.3 Ventilation Requirements



Warning

The accumulation of hydrogen can displace oxygen thereby creating an asphyxiation hazard. Always ensure that the equipment is operated in a well-ventilated area.

2.4.4 Water Supply Requirements

Generators fitted with an automatic water fill system maintain the water level from a gravity fed fresh deionized water supply. Refer to "Technical Specification" on page 3 for the supply requirements.



Caution

The use of any water, other than deionized water (Deionized, ASTM II, >1 MΩ, <1μS, filtered to <100μm), within this generator will damage and reduce the lifetime of the hydrogen cell.

The generator should be connected to the supply using 1/4" PTFE tubing (1/4" PTFE supplied). **Note.** The automatic water fill system is available as a factory or field fit optional extra. Contact Parker Hannifin for further details.

2.4.5 Electrical Supply Requirements

The equipment should be connected directly from the fused IEC 320 inlet socket to the electrical supply using the appropriate power cord supplied. The equipment should be positioned so that it can be connected to the electrical supply without the use of an extension cord.

It is the customer's responsibility to provide a fused electrical supply to the equipment (Refer to table 2 for the electrical specification). It is recommended that this supply have surge protection.



Warning

The equipment is connected to protective earth (ground) through the power cord. It is essential that electrical supply is equipped with a protective earth (ground) terminal. If an alternative power cord is used to connect the equipment to the electrical supply, ensure that it is suitably rated for the application and contains a protective earth (Ground) conductor.

3 Installation & Setup



Only competent personnel trained, qualified, and approved by Parker Hannifin should perform commissioning and service procedures.

3.1 Recommended system layout

Single Generator Setup

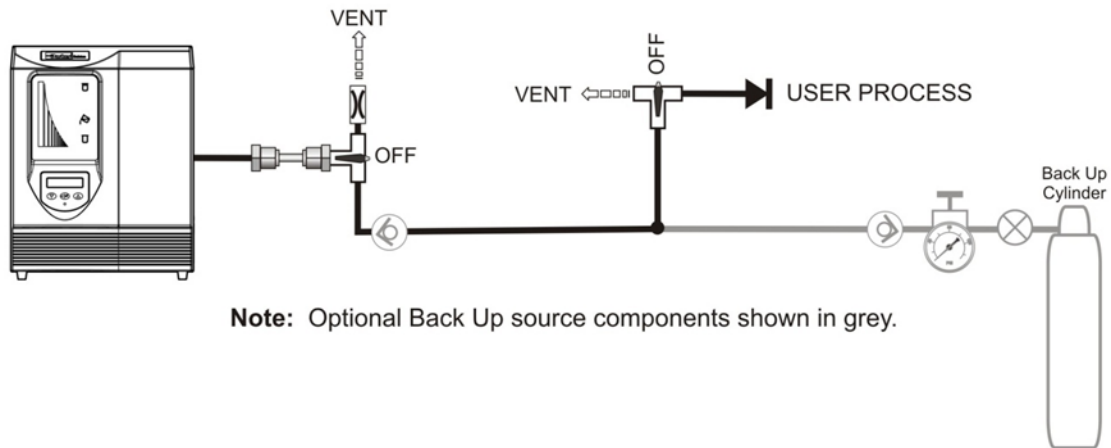

Note: Optional Back Up source components shown in grey.

Figure 3

Icon	Description	Part Number
	1/4" Compression Quick Connect (~1" Tube)	(make part)
	3-Way Valve 1/4" Compression S.S. or Brass	Local Supply Store
	O ₂ Vent Orifice (0.0016) 1/8" NPT connector, must adapt to this.	O'Keefe Controls PN: JSS-4-SS
	Check Valve (3psig cracking pressure)	SwageLock PIN: SS-4CA3 3-50psig
	Pressure Regulator 1/4" Compression S.S. or Brass	Local Supply Store
	Shut-Off Valve 1/4" Compression S.S. or Brass	Local Supply Store

Table 6

Note. For applications that require multiple generators, please contact your local Parker Hannifin office.

3.1.1 Installation Kit

Kit Number	Description
IK-0005	Hydrogen / Outlet Hard Copper Plumb
11417-1	Premium Copper Tubing 1/8"
11412-1	Premium Copper Tubing 1/4"

Table 7

The installation kits shown in table 7 will allow for installations as shown in figure 3. Please contact your local Parker Hannifin office for more details.

3.2 Connecting the generator

3.2.1 Environmental filters

Remove the transit plugs from the vent ports, on the rear of the generator, and fit the environmental filters as shown in figs. 4 and 5.

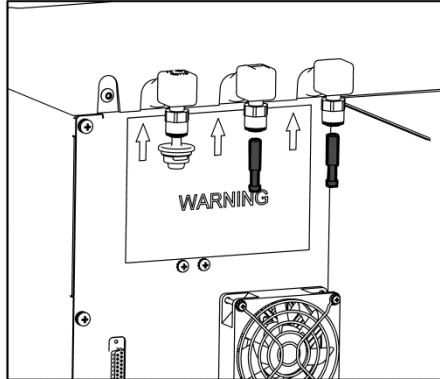

Figure 4

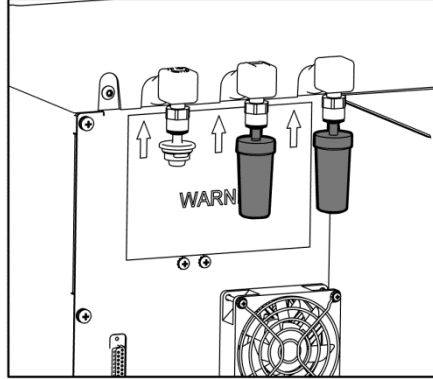

Figure 5

3.2.2 Hydrogen outlet port

Refer to "Recommended system layout" on page 7 for the desired system configuration.

The generator should be connected to the application instrument using either high quality stainless steel tube or grade (B-280) copper tube. Remove the compression plug from the hydrogen outlet port compression fitting. Insert the tube into the outlet port fitting and rotate the tube nut until finger tight. Using a spanner (wrench) tighten the nut one and one-quarter (1 1/4) turns. Take note that the hydrogen outlet port valve remains closed until unit has initialized. When cutting the tubes always use the correct tools to allow a clean perpendicular cut. Cutting tubes will cause debris that, if not removed, may damage the downstream instrumentation. It is recommended that all pipes are purged to remove any debris that may exist. When routing the tubes ensure that they are adequately supported to prevent damage and leaks in the system. All components used within the system must be rated to at least the maximum operating pressure of the equipment. Always protect the system by installing suitably rated pressure relief valves.



Warning To prevent injury, and damage to the application instrument, the system piping will require purging for at least 15 minutes to remove any trapped oxygen. If using a 3-way ball valve with vent line, as recommended on page 7, ensure that the valve is open to the vent line and not to the application instrument. If a ball valve is not being used, ensure that the application instrument is not connected to the system piping. Refer to "Commissioning the Generator" on page 11 for details on purging.

3.2.3 Drain ports

The overflow drain and the water bottle spillage drain must be permanently piped away using 1/2" and 1/4" PTFE tubing respectively. The tube connected to the overflow drain should have a u-bend to prevent contamination of the internal water bottle. Always check with local guidelines for disposing of deionized water.

3.2.4 Electrical supply

Check the rating plate for the correct supply voltage and frequency. Select the required power cord and connect it to the switched IEC 320 socket on the generator. Connect the plug directly to the electrical supply. Do not use an extension cord.

3.2.5 Filling the water bottle



Caution The use of any water, other than deionized water (Deionized, ASTM II, $>1\text{ M}\Omega$, $<1\mu\text{S}$, filtered to $<100\mu\text{m}$), within this generator will damage and reduce the life time of the hydrogen cell.

Fill the water bottle, as shown in figure 6, using fresh deionized water to a level approximately 15mm below the upper lip of the neck of the bottle. If the generator is powered up an audible and visual indication will be given when the correct level is reached. Wearing suitable gloves to prevent contamination, insert the deionizer cartridge into the water bottle and fit the cap securely.

3.2.6 Water supply (generators fitted with Auto Water Fill)

The water fill allows the generator's water bottle to be gravity fed from a suitable deionized water supply. When the water level falls below the mid-point, the water bottle will be replenished from the deionized water supply. Auto water fill is included with all H2PEMPD- 1100 and 1300. For H2PEMPD- 850, 650, 510 order part number XX-XXXX.

Connect the deionized water supply to the automatic water fill inlet using the adaptor provided and clean 1/4" PTFE tubing. It is recommended that a balance line is fitted at the inlet to prevent air locks. Flush the line through to remove any trapped air. Refer to "Technical Specification" on page 3 for water supply requirements.

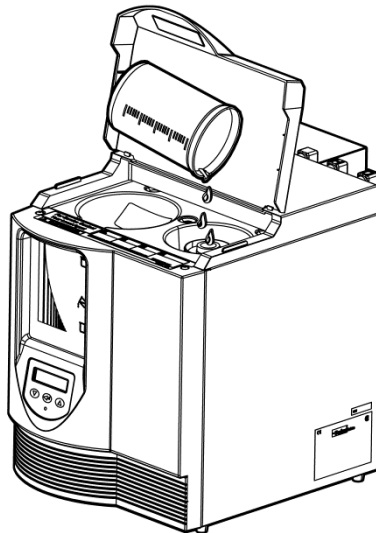

Figure 6

3.3 Options Board Accessory



Warning

The options board is designed for connection to Safe Extra Low Voltage (SELV) systems only. Maximum 12vdc 50mA.

The options board accessory allows direct communication with a PC via the USB port, and connection of water monitoring, remote alarm, and remote stop circuits. For applications requiring load balancing, please contact your local Parker Hannifin office.

3.3.1 Fitting the options Board

Plug the options board harness into the 15-way D-type connector on the rear of the generator. The harness should be secured in place using the retaining screws provided. The options board enclosure can be placed on the bench or behind the generator mounted to the wall.

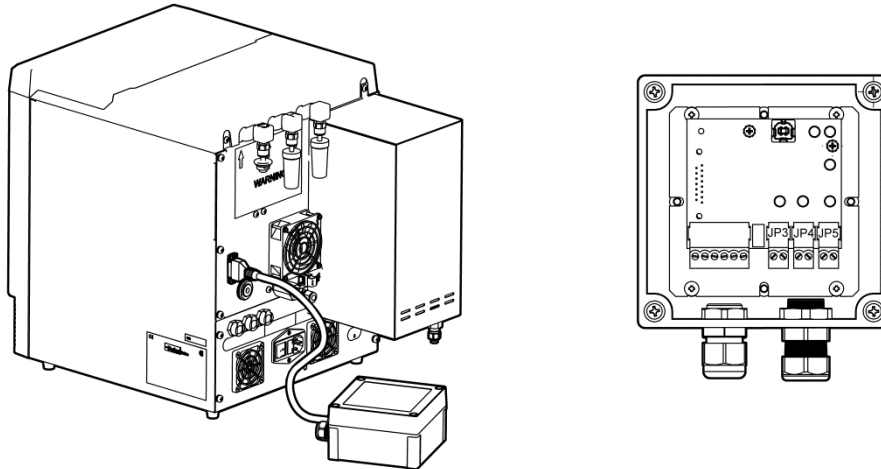



Figure 7

3.3.2 Wiring the Options Board

RS485	JP1_1	Not used (Do not connect)
RS485	JP2_1	Not used (Do not connect)
Remote stop	JP3_1	Switched input
	JP3_2	GND
Alarm output	JP4_1	Open collector output
	JP4_2	
Water fill output	JP5_1	Open collector output
	JP5_2	
USB	JP6	

Table 8

JP3 Remote Stop – The remote stop function allows the generator to be connected to an external stop circuit. Press  to reset the generator.

JP4 Alarm Output – The alarm output is designed for remote alarm indication. When an error occurs on the generator, the output switching circuit is activated causing the remote circuit to be complete.

The remote alarm circuit will be reset when the generator error has been reset.

JP5 Water Fill Output – The water fill output allows for remote monitoring of the water bottle level. When the water level drops below the mid-point in the water bottle, this output activates an external water fill system.

3.4 Starting up the Generator



Warning

Ensure that a suitable vent line is provided during the commissioning stage as hydrogen will flow from the unterminated system piping.

In order to guarantee the optimum efficiency of the PEM cell, this generator must be installed and running within three months of dispatch from Parker Hannifin. Failure to do this may invalidate the warranty. The generator will perform a 60 minute (1 hour) initialization sequence when powered for the first time. This sequence, which cannot be aborted, is necessary to guarantee the correct hydration of the cell.

- 1 Referring to the recommended set up (figure 3), use the 3-way ball valve to isolate the application instrument from the system and divert the flow to the vent line.

If a 3-way ball valve has not been installed, disconnect the application instrument from the system and connect the open ended piping to a suitable vent line

- 2 Connect the generator to the electrical supply and switch it on at the wall socket. Turn the generator on at the power switch (located on the rear of the generator) and wait.

The generator will perform a system check during which time the water bottle indicators will illuminate white then yellow, the system check LED will flash, and the software version number, generator serial number and the company banner will be displayed on the LCD.

On completion the generator will warm up and the display will show "Initializing". Once warm up is complete the unit will revert to the default menu as shown in figure 10.

Note: Upon first use, the generator may appear to stop building pressure while the separation chamber fills with water. Should this happen, restart the generator.

- 3 The internal pressure ("ACT" pressure) of the generator will build up to the required operating pressure ("SET" pressure). To achieve the required pressure at the process instrument, it is recommended that the set pressure of the generator be 10 psig above the required pressure (i.e. to achieve 50 psig at the instrument, set pressure of the generator should be 60 psig). Doing so will negate fluctuations in pressure due to the process and pressure drop within the process piping.
- 4 Once the required pressure is reached, the outlet valve of the generator will be opened, as indicated by "LOAD ✓" on the display. At this time, the hydrogen outlet port valve must be opened and hydrogen will flow through the system piping and out through the atmospheric vent line.
- 5 Close the 3-way ball valve to pressurize the system piping. Check for leaks and repair as required.
- 6 Open the 3-way ball valve to divert the flow to the application instrument.



Caution

During start-up, the generator may revert to the last error mode it experienced. If this occurs press .

When the error is cleared, the generator will continue with the start up procedure. If the error cannot be cleared by this method follow the fault finding procedure in section 6 of this user guide.



Caution

If the pressure envelope of the system has been breached it will be necessary to run through this procedure when starting the generator.

4 Operating the equipment

4.1 Overview of controls

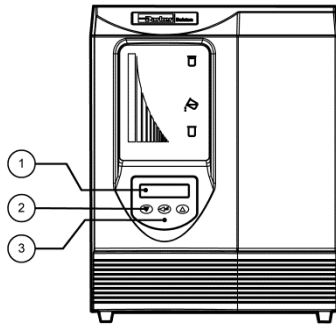

Figure 8

1	16 x 2 line menus display	
2	Control keypad used for menu navigation and generator operation	
3	Tri-colored system check indicator	
	Indicator	Generator status
	Flashing green	Startup Initialization
	Solid green	On-line
	Flashing red	Non critical errors
	Red	Critical errors (system locked)
	Amber	On-line, service required

Table 9

4.2 Starting the equipment

Connect the generator to electrical supply and switch it on at the wall socket. Turn the generator on (I) at the power switch (located on the rear of the generator) and wait.

The generator will perform a system check during which time the water bottle indicators will illuminate white then yellow, the system check LED will flash, and the software version number, generator serial number and the company banner will be displayed on the LCD.

Upon completion, the generator will enter INITIALIZING mode while the purifier is heating. Once complete it will revert to the default menu as shown in figure 10.

Note: Upon first use the generator may appear to stop building pressure while the separation chamber fills with water. Should this happen, restart the generator. The internal pressure (“ACT” pressure) of the generator will build up to the required operating pressure (“SET” pressure). Once the required pressure is reached, the outlet valve of the generator will be opened, as indicated by “LOAD ✓” on the display shown in figure 9, and hydrogen will be supplied to the application instrument.

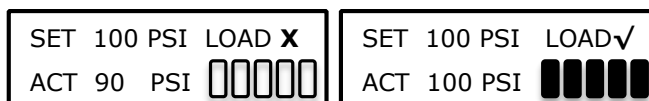



Figure 9



If the generator is being powered for the first time, it will take approximately 48 hours for the generator to reach the purity specified.

During start-up the generator may revert to the last error mode it experienced. If this occurs press [OK]. When the error is cleared the generator will continue with the startup procedure. If the error cannot be cleared by this method follow the fault finding procedure in section 6 of this user guide.

4.3 Operating Menus

There are 8 menus used by the generator to display and access operational parameters and data. These can be accessed from the default menu by sequentially pressing  on the control panel. These menus are shown in table 10.







1		Default
2		Conductivity (water quality)
3		Pressure - units of measurement
4		Run time / Service interval
5		Flow
6		Error log
7		Generator self test

Table 10

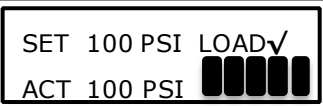
4.3.1 Default Menu

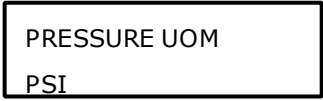
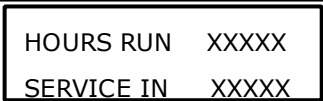
The default menu displays the following data:

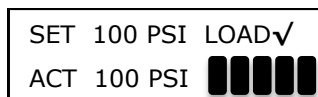





Figure 10

SET - The outlet pressure required by the application.

The required outlet pressure can be adjusted up and down using the  and  keys respectively.

ACT - Current actual internal / outlet pressure of the generator.

LOAD X/✓ - Indicates the status of the generator outlet valve. "X" - Outlet is closed, "✓" - Outlet is open.

 100% - The shaded blocks indicate the rate of hydrogen production. Each block represents 20% of the rated capacity of the generator.

During initial startup, all five blocks will be shaded indicating that the generator is building up pressure and not currently on line. When the generator is on-line and delivering gas to the application, the number of blocks shaded will depend upon the flow required by the application.

Stand by Mode—The flow of hydrogen to the application can be interrupted by switching the generator into standby mode.

Press and hold  to select stand by. The default menu will change to the standby menu as shown to indicate that the outlet valve is closed and hydrogen is no longer being supplied to the application.

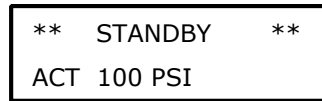



Figure 11

To return to normal operation, press .

Reset—Pressing the enter key (middle key) during an error condition will reset the system.

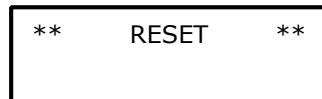

Figure 12

4.3.2 Conductivity

The conductivity menu gives a graphical indication of the water quality. When all 10 blocks are shaded the water quality is to specification.

When the number of shaded blocks drops to four, the “Change Water” error message will be displayed, the water bottle indicator will flash yellow, and an intermittent alarm will sound. Hydrogen will continue to be delivered to the application.

If the water quality degrades to the point at which none of the blocks are shaded, the outlet valve of the generator will close and a conductivity error will be generated. The water bottle indicator will illuminate yellow and a continuous alarm will sound. Hydrogen will not be delivered to the application.

Press  to advance to the next menu.

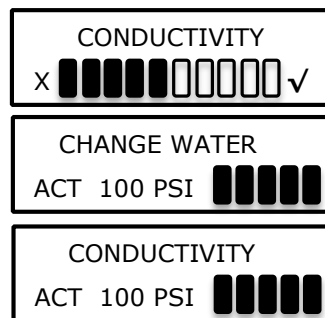





Figure 13



The water bottle should be drained and refilled with deionized water, ASTM II, >1 MΩ, <1μS, filtered to <100μm at the earliest convenient time.

4.3.3 Pressure Measurement

The units of pressure measurement may be changed between bar, psi and Mpa. Press  or  to change the units of measurement. When the desired units have been selected, press  to advance to the next menu

4.3.4 Run Time Data

The Run Time Data Menu displays the following data:

HOURS RUN - Time in hours that the generator has been producing hydrogen.

SERVICE IN -The time in hours that the generator can produce hydrogen before a service is required.

HOURS RUN	XXXXX
SERVICE IN	XXXXX

Figure 14

4.3.5 Flow

The Flow menu displays the current flow and the total amount of hydrogen produced by the generator when on-line.



Flow ml/min. - Current flow in ml/min being produced by the generator. This is for qualitative indication only and we recommend the use of a flow meter to gain an accurate measurement.



Liters - Total amount of hydrogen produced by the generator measured in liters.

FLOW ml / MIN	000
LITERS	000

Figure 15

4.3.6 Error Log

The Error Log menu allows the user to access the 10 most recent error messages. To access the errors press and hold  .

The menu will display the most recent error, message number "0", along with the date and time of when the error occurred. Use the  and  keys to scroll through the remaining error messages. Press  to return to the error log menu.





ERROR LOG	
HOLD  & 	
DD/MM/YY HH:MM	0
* DESCRIPTION *	

Figure 16

4.3.7 Generator Self-Test



The generator must be disconnected from the system when running the self-test routine.

From the Self-Test Menu press and hold  and . As the generator runs through the test routine, the menus will change as follows:

Pressure release— All pressure within the generator is released. The test will not proceed until the generator is fully depressurized.

Pressure build—The generator is pressurized to a maximum operating pressure of 100 or 175 psi g (6.89 or 12.06 bar g). The time taken to reach this pressure is monitored by the generator.

Pressure Hold—The pressure is held for a predetermined time and then monitored for decay.

Pressure Release—The outlet solenoid valve opens to release all pressure within the generator.

Test Passed / Failed—Once fully depressurized the generator switches to standby and the result of the test is displayed.

NOTE: *Always perform a self-test whenever the pressure circuit has been disturbed e.g. changing the desiccant cartridge.*

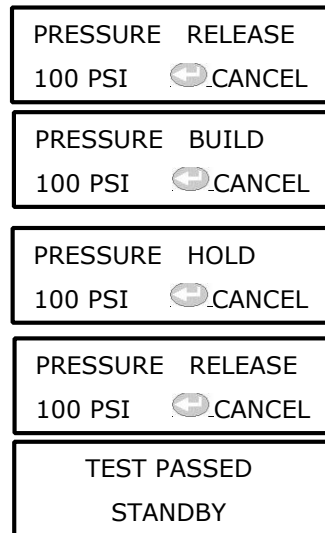

Figure 17

4.4 Hard Reset

If a critical error occurs, an error lock menu will be displayed and the generator will need to be hard reset. If an overpressure, H2 or O2 vent blocked error occurs, the generator will need to be hard reset once the problem has been resolved. This will also be the case if the same error is reset 3 times consecutively.

Before a hard reset is performed the initial fault must be rectified; refer to “Error Messages” on page 21 for guidance. When the faults are rectified, switch the generator off at the mains switch.

Press and hold [←]. At the same time reapply the power to the generator. When the generator has powered up press [→] again. The generator will reset all errors then continue with the normal start up procedure.

4.5 Stopping the equipment and depressurizing



Warning

Ensure that the generator is fully depressurized prior to shipment or servicing.

- 1 Ensure that the application instrumentation no longer requires hydrogen.
- 2 Switch the generator off at the mains power switch and disconnect it from the electrical supply.
- 3 Slowly disconnect the Hydrogen outlet connection pipe from the back of the generator allowing the system to depressurize. Once depressurized, close the hydrogen outlet valve port.



Warning

Hydrogen gas will escape under pressure when the piping is disconnected.

- 4 The generator is now shut down.
- 5 If the generator is to be transported drain the water from the generator as described in section 6. Refit the hydrogen outlet port plug and the two transit plugs to the excess H2 vent and the water bottle vent.

5 Servicing

The recommended service procedures identified below, along with all other repair and calibration work should be undertaken by a Parker Hannifin approved engineer.

5.1 Cleaning

Clean the equipment with a damp cloth only and avoid excessive moisture around any electrical sockets. If required you may use a mild detergent, however do not use abrasives or solvents as they may damage the warning labels on the equipment.

5.1.1 Service Intervals

Component	Operation	Daily	6 months (4000 Hrs.)	24 Months (16000 Hrs.)											
Generator	Check the power ON indicator is illuminated														
Generator	Check the STATUS / FAULT indicator on the control panel														
Generator	Check the water level														
Generator	Check the water conductivity														
Generator	Check the water bottle spillage drains														
Generator	Check for leaks														
Generator	Recommended Service A 6 Month Service														
Generator	Recommended Service B 24 Month Service														
Service	6 months (4000 Hrs.)	12 Months (8000 Hrs.)	18 Months (12000 Hrs.)	24 Months (16000 Hrs.)	30 Months (20000 Hrs.)	36 Months (24000 Hrs.)	42 Months (28000 Hrs.)	48 Months (32000 Hrs.)	54 Months (36000 Hrs.)	60 Months (40000 Hrs.)	66 Months (44000 Hrs.)	72 Months (48000 Hrs.)			
A															
B															
Key:															
	Check		Essential Procedure												

Table 11

5.2 Service Kits

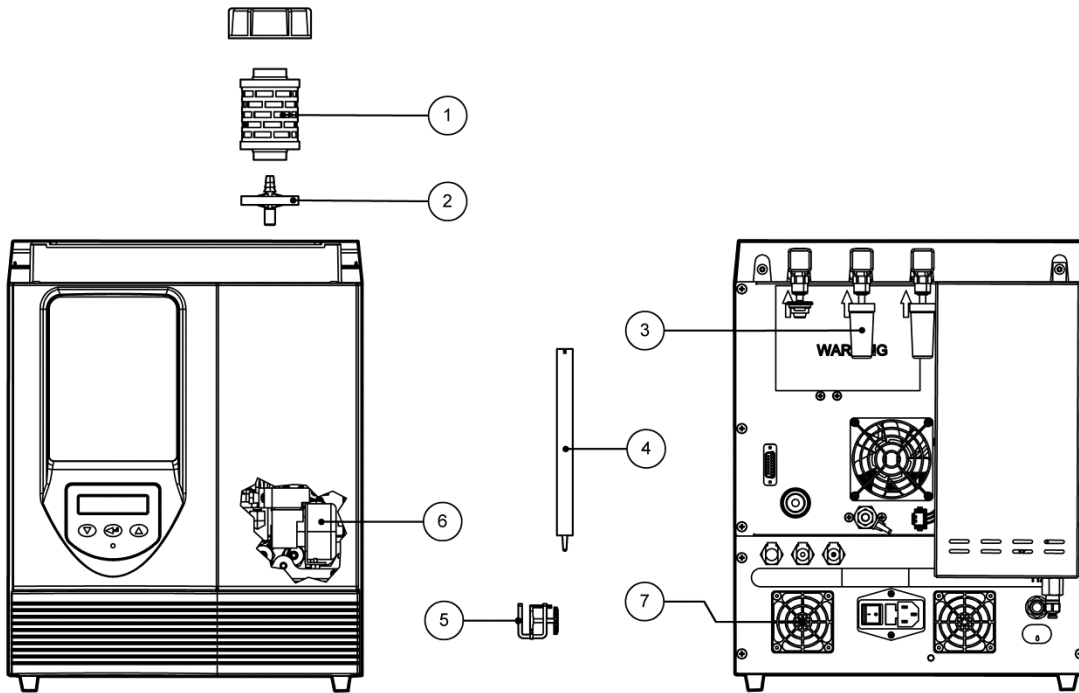

Figure 18

5.2.1 Recommended Service A - Required every 4000Hrs (6 months)

	Description	Kit No.	Contents
	Filter Service	MKH2PEMPD-6M	1. Deionizer cartridge 2. 100 micron water filter 3. Environmental filters (x2) 4. Filter replacement tool

Table 12

5.2.2 Recommended Service B - Required every 16000Hrs (24 months)

	Description	Kit No.	Contents
	Complete Service	MKH2PEMPD-24M	1. Deionizer cartridge 2. 100 micron water filter 3. Environmental filters (x2) 4. Filter replacement tool 5. Tube clamp 6. Water pump 7. Fan guard (x2)

Table 13

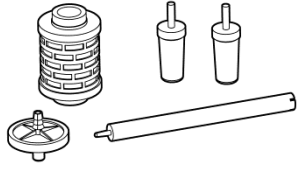
5.3 Consumable Replacement Procedures

5.3.1 Draining the water bottle

Locate the drain port (figure 2) on the rear of the generator and insert the drain line. Ensure that the line is locked in position to obtain a complete seal. Leave the water to drain into a suitable container, then press the lock downwards and remove the line.

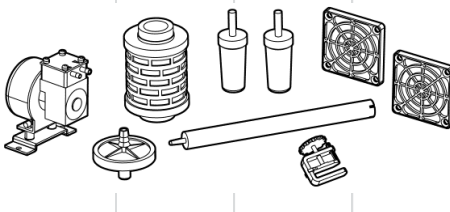

In order to prevent contamination and prolong the life of the cell do not reuse the old water.

5.3.2 Replacing the deionizer cartridge and 100 micron water filter



Change the deionizer cartridge every 4000 hours (6 months), or if it has become contaminated.



Switch the generator into Standby mode. Remove the top front cover as shown in figure 19. Remove the water reservoir cap.

Wearing disposable gloves, remove the deionizer cartridge (figure 18, item 1) and discard. Extract the 100 micron water filter (figure 18, item 2) using the H2 filter replacement tool (figure 18, item 4). Push the tool over the filter so that the webs on the filter fit into the slots on the end of the tool. Unscrew the filter and remove it from the water bottle as shown in figure 20.

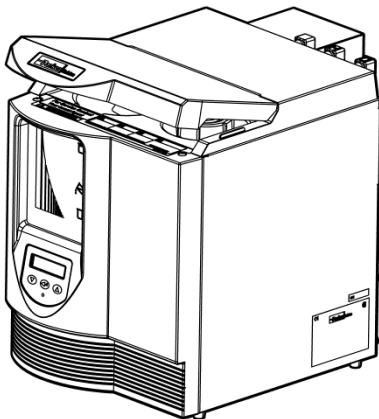

Figure 19

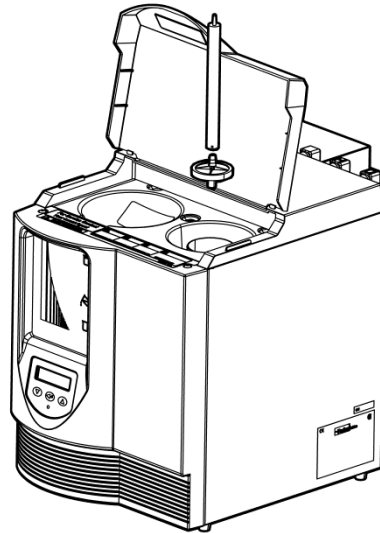

Figure 20

Fit the replacement filter and ensure that it is secured into the water bottle. Refill the water bottle with deionized water, ASTM II, >1 MΩ, <1μS, filtered to <100μm, as described below, and fit the replacement deionizer cartridge.

Refit the water reservoir cap and the top front cover and restart the generator.

5.3.3 Replacing the Environmental Filters

Remove the two environmental filters (figure 18, item 3) from the vent ports by pushing the push in fitting upwards to release. Fit the replacement filters and check that they are secure.

Note: Environmental filters should be changed every six months as there is no visual indication of exhausted filters.



5.3.4 Replacing the Water Pump

Lift the upper service panel from the generator as shown in figure 19 and store the panel safely. Remove the two retaining screws from the top of the front fascia panel. Slide the panel upwards until the locating screws are free from their retaining slots. Carefully move the panel away from the generator as shown in figure 21. Disconnect the display assembly ribbon cable from the control board and store the panel safely. Remove the two retaining screws from the top rear cover as shown in figure 22. Remove the outer heater box being careful of the internal tubing connection. Slide the top rear cover off and store the panel safely as shown in figure 22.

With the Environmental filters still removed, carefully remove the push in fittings from the water reservoir. Remove the retaining screws from the back panel as shown in figure 22. Carefully open the back panel allowing it to rest on the cable stop as shown in figure 23. With the back panel open, carefully disconnect the 4 pin pump connector from the PUMP terminal.

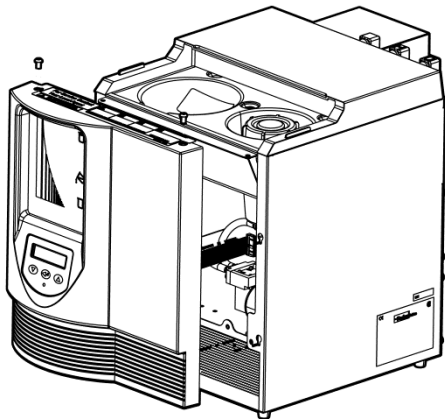

Figure 21

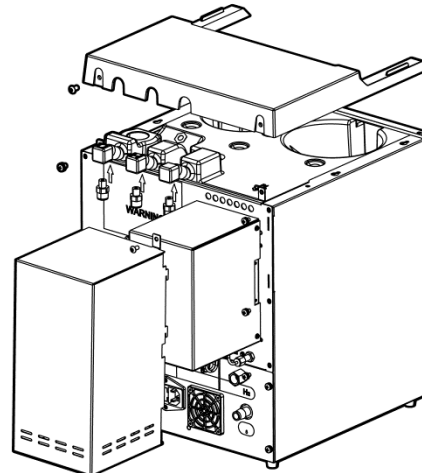

Figure 22

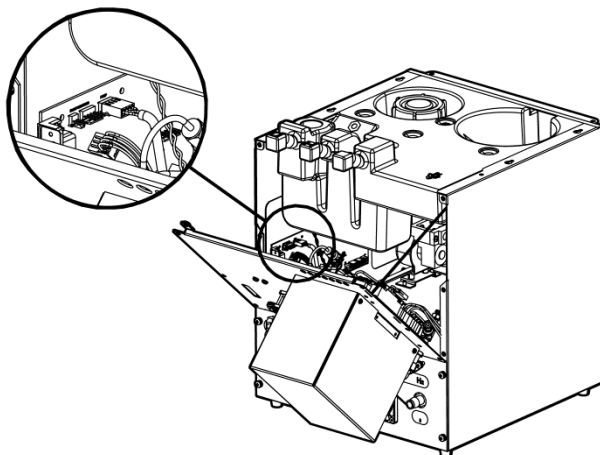

Figure 23

With all the water drained from the water reservoir, place some paper toweling in the bottom of the generator to catch any residual water within the tubes and water pump. As shown in figure 24, clamp the water pump inlet tube and remove the associated hardware. Fit the replacement pump and reconnect the wiring and tubing.

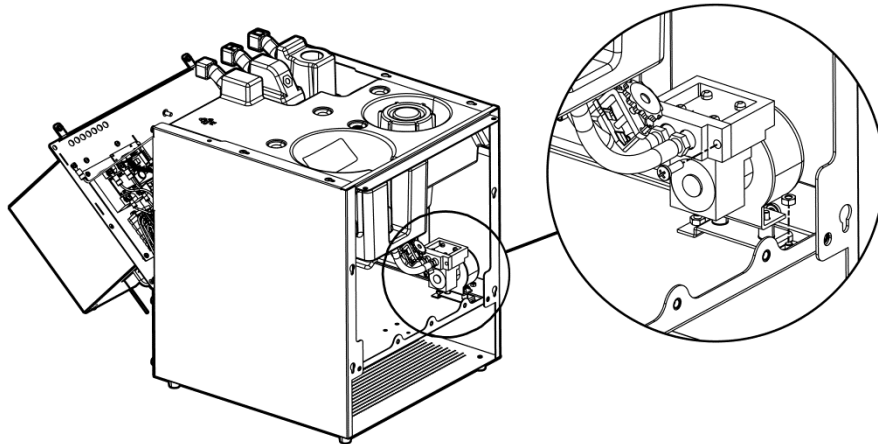

Figure 24

5.3.5 Replacing the Fan Guards

Remove the 4 retaining screws from each fan guard (figure 18, item 7). Fit the replacement fan guards and secure using the previously removed screws.

5.3.6 Filling the water bottle



The use of any water, other than deionized water (ASTM II, $>1 \text{ M}\Omega$, $<1\mu\text{S}$, filtered to $<100\mu\text{m}$ within this generator will damage and reduce the life time of the hydrogen cell.

Remove the top front cover and the water bottle cap. Fill the water bottle using fresh deionized water to a level approximately 15mm below the upper lip of the neck of the bottle.

If the generator is powered during refilling, an audible and visual indication will be given by the generator when the correct level is reached, and the LCD will display "Water Full" message. Once full replace the water bottle cap and top front cover.

Note: If the water has been changed due to high conductivity, the deionizer cartridge must also be changed.

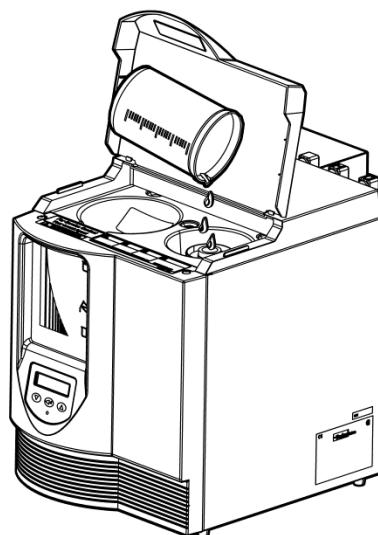

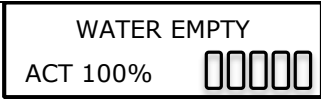
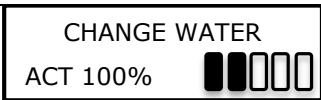
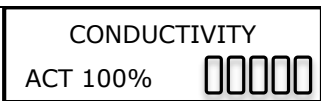
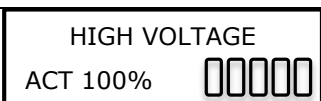
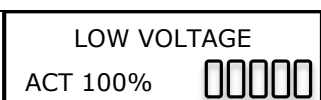
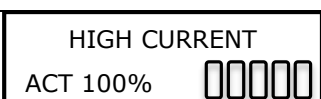
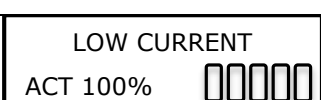
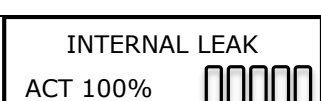
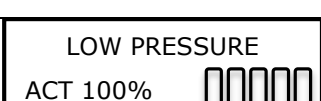
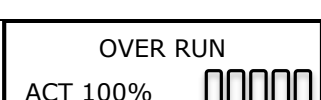













Figure 25

6 Error Messages

When an error occurs the LCD will cycle between the default menu and the error message. In addition to the error messages the generator will provide a visual and audible indication using the System Check LED, Water Bottle Indicator and its integral sounder.

LCD Display	Cause	Generator Status	Action
	Water below the midpoint	On	Fill with Deionized, ASTM II, >1MΩ, <1μS, filtered to <100μm
	Water below the minimum point	Off	Fill with Deionized, ASTM II, >1MΩ, <1μS, filtered to <100μm
	Water conductivity HIGH	On	Drain and refill with Deionized, ASTM II, >1MΩ, <1μS, filtered to <100μm
	Water conductivity HIGH	Off	Drain and refill with Deionized, ASTM II, >1MΩ, <1μS, filtered to <100μm
	Cell voltage HIGH	Off	Reset or hard reset. Contact tech support for cell or PSU replacement if the problem persists.
	Cell voltage LOW	Off	Reset or hard reset. Contact tech support for cell or PSU replacement if the problem persists.
	Cell current HIGH	Off	Reset or hard reset. Contact tech support for cell or PSU replacement if the problem persists.
	Cell current LOW	Off	Reset or hard reset. Contact tech support for cell or PSU replacement if the problem persists.
	Faulty H2 line internal connection	Off	Check all H2 line connections
	Cell low pressure	Off	Check/eliminate overflow condition
	Generator/Cell operating at >100% capacity	Off	Check/eliminate overflow condition

<p>OVER PRESSURE</p> <p>ACT 100% </p>	Generator/Cell HIGH pressure	Off	Contact tech support/ PSU, PCB, Transducer fault
<p>PRESS XDUCER 1</p> <p>ACT 100% </p>	No cell pressure signal	Off	Reset/replace, check connection
<p>PRESS XDUCER 2</p> <p>ACT 100% </p>	No output pressure signal	Off	Reset/replace, check connection
<p>COND XDUCER</p> <p>ACT 100% </p>	Faulty, no signal	On	Reset/ check sensor connection
<p>SEPARATOR BLOCK</p> <p>ACT 100% </p>	Cell separator water level HIGH	Off	Check/replace sensor or connection
<p>CALIBRATION</p> <p>ACT 100% </p>	Calibration file out of date	On	Calibrate conductivity sensor
<p>WATCHDOG</p> <p>ACT 100% </p>	Software timeout	Off	Reset/contact tech support
<p>WATER PUMP</p> <p>ACT 100% </p>	Pump fault – no cell water circulation	Off	Check/replace pump or connection
<p>PSU FAN FAIL</p> <p>ACT 100% </p>	Power supply fan not rotating	Off	Reset/replace the fan
<p>CASE FAN FAIL</p> <p>ACT 100% </p>	Case cooling fan not rotating	On	Reset/replace the external fan
<p>O2 FLOAT CONNECT</p> <p>ACT 100% </p>	Reservoir level sensor faulty	Off	Reset/check connector, replace sensor
<p>TEMP XDUCER</p> <p>ACT 100% </p>	Purifier temp sensor faulty	Off	Reset/check connector. Replace heater

<p>TEMP RATE ACT 100% 000000</p>	<p>Purifier temp rise rate = low</p>	<p>Off</p>	<p>Reset/check connector. Replace heater</p>
<p>OVER TEMP ACT 100% 000000</p>	<p>Purifier temp HIGH</p>	<p>Off</p>	<p>Reset/check connector. Replace heater</p>
<p>LOW TEMP ACT 100% 000000</p>	<p>Purifier temp LOW</p>	<p>Off</p>	<p>Reset/check connector. Replace heater</p>
<p>SERVICE REQUIRED ACT 100% ■■■■■■</p>	<p>Service time</p>	<p>On</p>	<p>Perform service. Use applicable kit</p>
<p>O2 VENT BLOCK ACT 100% 000000</p>	<p>O2 vent is blocked</p>	<p>Off(System lock)</p>	<p>Reset/remove blockage & reset</p>
<p>REMOTE STOP ACT 100% 000000</p>	<p>JP3 on options board shorted</p>	<p>Off</p>	<p>Remove short/reset</p>

Remember To:

Complete and Mail or Fax in Your Warranty Registration Card.
Keep your product certification in a safe place.

Contact:

Contact the Technical Services Department at 1-800-343-4048, 8AM to 5PM Eastern Time (North America only) or email at balstontech-support@parker.com.

For other locations, please contact your local representative or email at TSGIndustrial.Enquiries@parker.com.



Parker Hannifin Corporation
Industrial Gas Filtration and Generation Division
4087 Walden Ave.
Lancaster, NY 14086
Tel: 716-686-6400 Fax: 877-857-3800
www.lbgasgenerators.com

Parker Hannifin Manufacturing Limited
Gas Separation & Filtration Division EMEA
Dukesway, Team Valley Trading Estate
Gateshead, Tyne and Wear, England NE11 0PZ
Tel: +44 (0)191 402 9000 Fax: +44 (0)191 482 6296
www.parker.com/gsfte dhFNS_TSG@parker.com

CELL: SPE