

*Instructions for using*  
**SINGER**  
*Sewing Machine 301*



**THE SINGER MANUFACTURING COMPANY**

*Revolutionary*

---

# SINGER\*

## SEWING MACHINE (301)

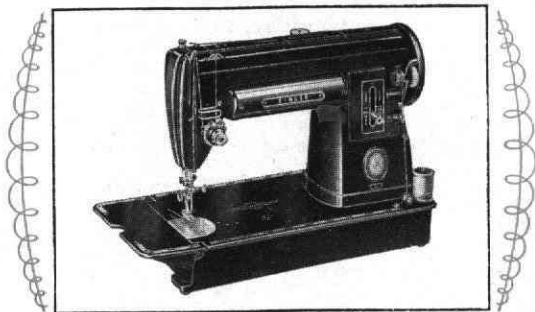

. . . . . represents the ultimate in sewing machine design and styling. A product of the matchless skill and engineering ability of **SINGER** craftsmen, the **SINGER** Class 301 is an outstanding addition to our long line of unexcelled Sewing Machines.

**AS THE OWNER OF THIS ENTIRELY NEW  
SINGER SEWING MACHINE:**

You have a machine revolutionary in design, but made with the same care and craftsmanship that have been the hallmark of SINGER Machines for more than a century. We are acutely aware that SINGER Sewing Machines have become an American tradition and are intensely proud of, and determined to continue, this heritage.

Your SINGER "301" is the product of this pride, determination and the unsurpassed technical skill of SINGER. This smooth-running machine-of-tomorrow will amaze and thrill you with its versatility and ease of operation.

Utilize all the advanced features, combine them with your own skill and discover a new world of sewing enjoyment. Exclusive dresses for yourself, clothing for your family and a multitude of items for your home will be yours — all at a fraction of their ready-made cost.

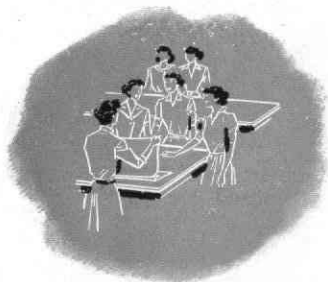

## WHAT SINGER SERVICE MEANS TO YOU

Over 1200 SINGER SEWING CENTERS in the United States alone are fully equipped to serve women who sew.

There you'll find a wide selection of FABRICS, PATTERNS, BUTTONS, THREAD, and FINISHING SERVICES which include COVERING BUTTONS, BELTS AND BUCKLES, making BUTTONHOLES, HEMSTITCHING, etc., plus:

FREE INSTRUCTION in "Sewing Skills" given to purchasers of new SINGER Sewing Machines. Skilled teachers give personalized instruction in home dressmaking, home decoration and Fashion Stitching. They will also assist you in the selection of accessories best suited to your particular needs.

REPAIR SERVICE is as convenient as your telephone. Whenever your machine needs adjustments, a trained, courteous SINGER representative will gladly call at your home. SINGER\* Service assures excellent workmanship, guaranteed repairs, and SINGER\* parts. A written estimate is given you in advance for approval.

And remember, your SINGER SEWING CENTER and the ever ready SINGER Service Car can be easily identified by the famous SINGER Red "S" Trade Mark.

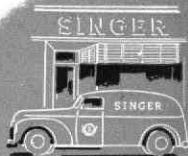

**SINGER 301 FEATURES "AT YOUR SERVICE"**

- **SMOOTHER STITCHING** than ever before is possible with this new, gear-driven, lock-stitch machine.
- **QUIET**, fast and efficient — it whispers at high speeds.
- **FULL-VIEW** work area. Inclined Needle Bar places work in your direct line of vision.
- **PERFECT CONTROL** — even at "hand-stitch" speeds.
- **BALANCED MOTION** of the new SINGER 301 prevents vibration.
- **EASY STARTING** — No coaxing necessary — lightly press the knee or foot control and your 301 starts to sew.
- **SIMPLE THREADING** — no complicated diagrams are needed.
- **REVERSIBLE FEED** for sewing either in a forward or backward direction—easy to back tack and to fasten ends of seams.
- **PREFOCUSED SINGERLIGHT\*** illuminates working area — prevents eye strain.
- **CALIBRATED STITCH REGULATOR** permits finger-tip control of stitch length.
- **STITCHING GUIDES**, with graduated markings to guide seam width and turn square corners.
- **VERSATILE** — use it as a portable or cabinet machine.
- **EASY TO CARRY** — convenient handle is concealed in top of head.
- **LIGHT WEIGHT** — full-sized aluminum head weighs only 16 pounds.

- **SELF-SETTING NEEDLE** makes it impossible to insert needle incorrectly in clamp.
- **FEED THROW-OUT DEVICE** permits darning and embroidering without attachments.
- **RECESSED BOBBIN WINDER**—equipped with automatic stop — it can't break or tangle your thread.
- **HINGED BED EXTENSION** permits quick and easy removal of bobbin.
- **HINGED FACE PLATE**—Simplifies cleaning and oiling.
- **DIAL TENSION** takes the guess work out of upper tension setting.
- **FLEXIBLE SPOOL PINS** — bend but do not break—thread unreels smoothly and easily.
- **COMPLETELY ENCLOSED** motor and principal working parts insure maximum safety.

### ELECTRICAL INFORMATION

#### *The SINGER\* electric motor*

in your sewing machine is furnished for operation on an alternating current of 110-120 volts, 25 to 75 cycles, or on 110-120 volts direct current. Special motors can be provided through your SINGER SEWING CENTER for direct or alternating current for any volt-

age between 20 and 250, and for 32 volts direct current.

#### *Before Inserting Electric Plug—*

be sure that the voltage and the number of cycles stamped on the motor nameplate are within the range marked on your electric meter installed by your power company.

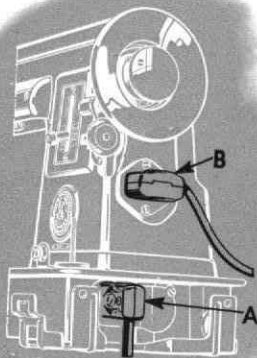

*Fig. 1. Electrical Connections for Machine*

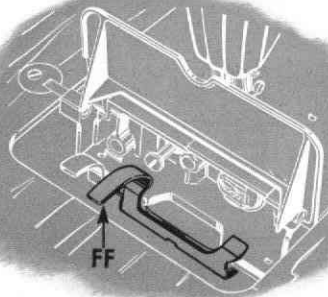

*Fig. 2. Showing Latch for Releasing Machine from Cabinet*

### **ELECTRICAL CONNECTIONS FOR MACHINE**

Push 2-pin terminal plug **A**, **Fig. 1** on 2-pin terminal block at right end of bed.

Push 3-pin terminal plug **B**, **Fig. 1** on 3-pin terminal block at right of machine and connect plug at other end of cord to electrical outlet.

### **Speed Controller**

The speed of machine is regulated by amount of pressure on the pedal of the foot controller or the knee lever.

### **TO USE THE 301 AS A PORTABLE MACHINE**

To remove the machine from the cabinet, disconnect the 3-pin terminal plug **B**, **Fig. 1**, lift handle **C**, **Fig. 3**, raise bed extension at left, depress latch **FF**, **Fig. 2**, and lift out machine. Disconnect 2-pin terminal plug **A**, **Fig. 1** and set machine aside. Then remove controller from its holder in cabinet by pulling it downward. With machine set on a suitable surface near an electrical outlet, reconnect 2-pin and 3-pin terminals and place foot controller on floor.



### HANDLE FOR CARRYING MACHINE

To use handle **C**, turn it up, as shown in **Fig. 3**. When not in use, turn handle down.

**CAUTION:** When you have finished your sewing, always disconnect plug from electrical outlet.

### TO REPLACE MACHINE IN CABINET

Disconnect both terminal plugs. Grasping handle **C**, **Fig. 3**, place machine in cabinet so that holes **MM**, **Fig. 3A**, fit over studs **NN** in machine cradle. Press down on left end of machine until latch **FF**, **Fig. 2**, snaps into position to hold machine in place. Tilt back ma-

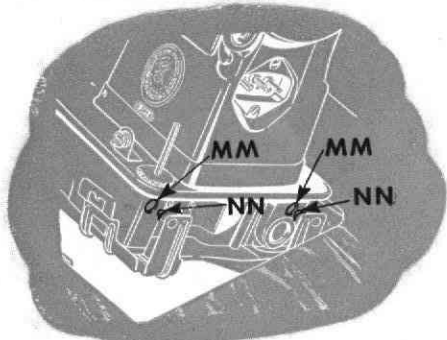

*Fig. 3A. To Replace Machine in Cabinet*

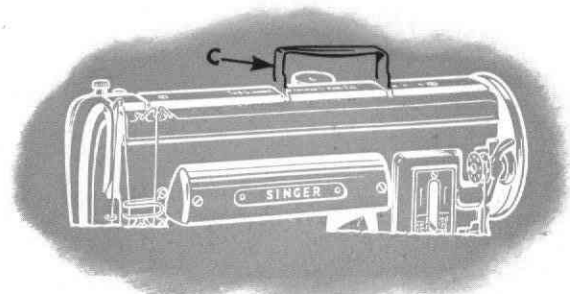

*Fig. 3. Showing Handle for Carrying Machine*  
chine with cradle, install controller in side of cabinet as shown in **Fig. 3B**, then connect 2-pin terminal. Lower machine to sewing position and connect 3-pin terminal.

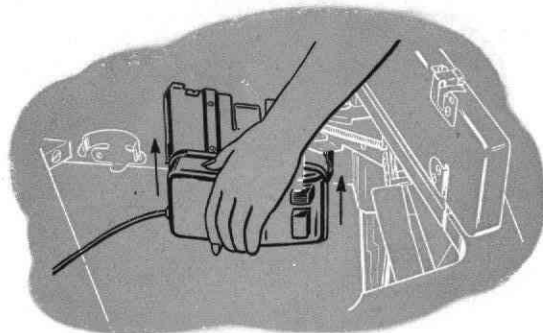

*Fig. 3B. Replacing Controller in Cabinet*

**SINGERLIGHT\***

The SINGERLIGHT is turned "on" or "off" by the switch **F**, **Fig. 4**.

**To Remove Bulb.** Remove two screws **D** and lamp cover **E**. Do not attempt to unscrew bulb. Press it into socket and at same time turn bulb over in direction shown in **Fig. 4B** to unlock bulb pin **G**, then withdraw bulb.

**To Replace Bulb.** Press new bulb into socket with bulb pin **G**, **Fig. 4A** entering slot of socket and turn it over in direction shown in **Fig. 4B** to lock bulb pin **G** in position. Replace lamp cover **E** and securely fasten it in position with two screws **D**.

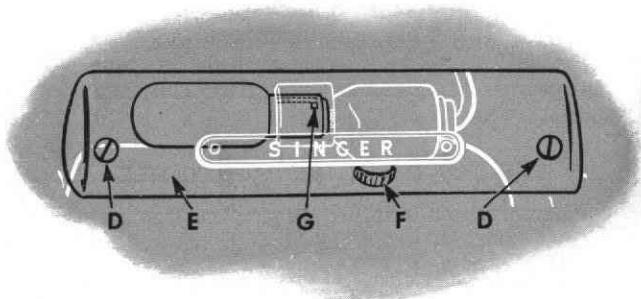

*Fig. 4. Replacing the Bulb*

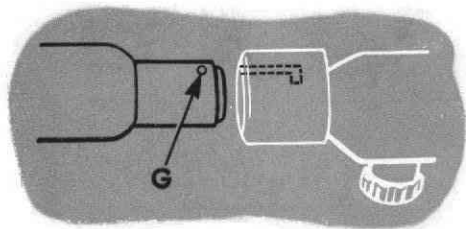

*Fig. 4A.*

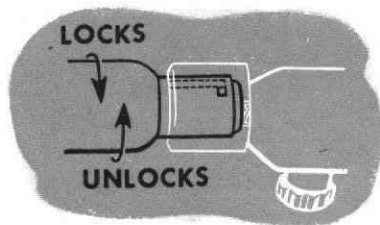

*Fig. 4B.*

## NEEDLES AND THREAD

For perfect stitching, thread should be selected according to fabric to be stitched and needle must be correct size for thread which must pass freely through eye of needle.

## TO SET THE NEEDLE

Select correct needle according to table on page 64. Be sure that needle is not blunt or bent. Raise needle bar to its highest position and loosen thumb screw **H** in needle clamp. Push needle **with its flat side to left** up into needle clamp as far as it will go, then tighten thumb screw. As the needle is self-setting, it cannot be inserted incorrectly in the needle clamp.

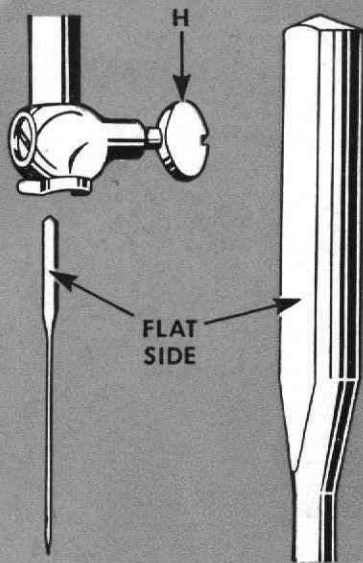

*Fig. 5. Setting the Needle*

10

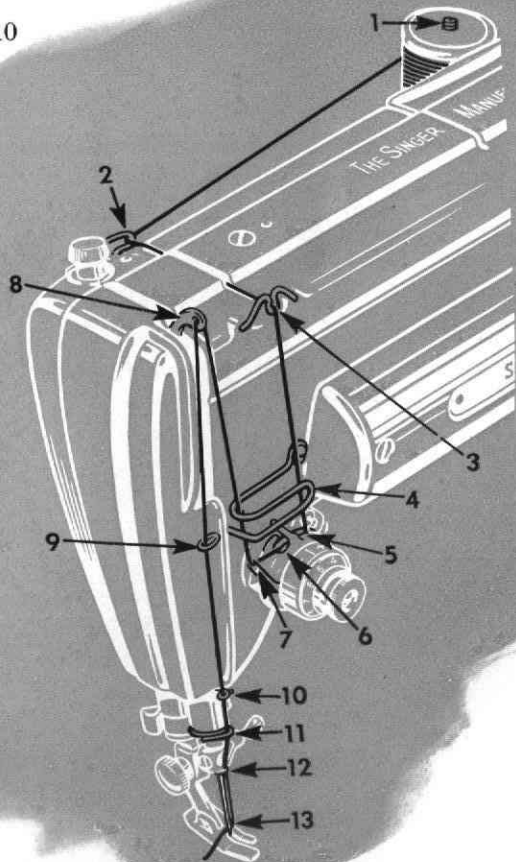

*Fig. 6. Upper Threading*

**UPPER THREADING**

*See Figs. 6 and 7*

**Raise take-up lever 8 to its highest point.**

Place spool of thread on spool pin 1

Lead thread into thread guide 2

Into thread guide 3

Down into thread guide 4

Down, under and from right to left between tension discs 5

Hold spool tightly and pull thread up against take-up spring 7 until it enters retaining fork 6

Pass thread up into thread guide 4

From right to left through hole in take-up lever 8

Down through eyelet 9

Into wire thread guide 10

Into wire thread guide 11

Into guide 12 on needle clamp

From **right to left** through eye of needle 13.

Draw about two inches of thread through eye of needle.

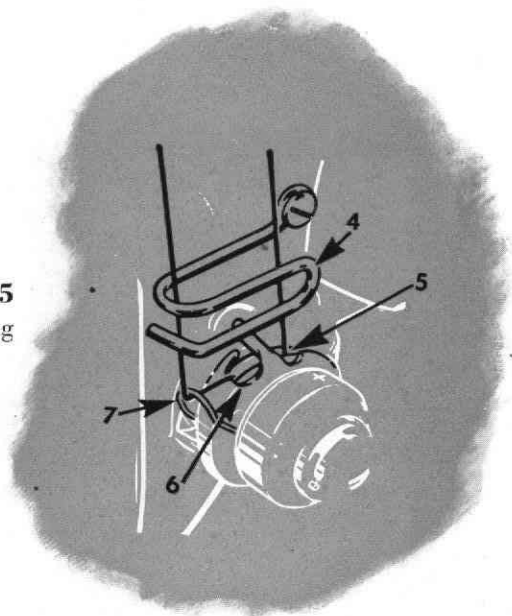

*Fig. 7. Upper Threading*

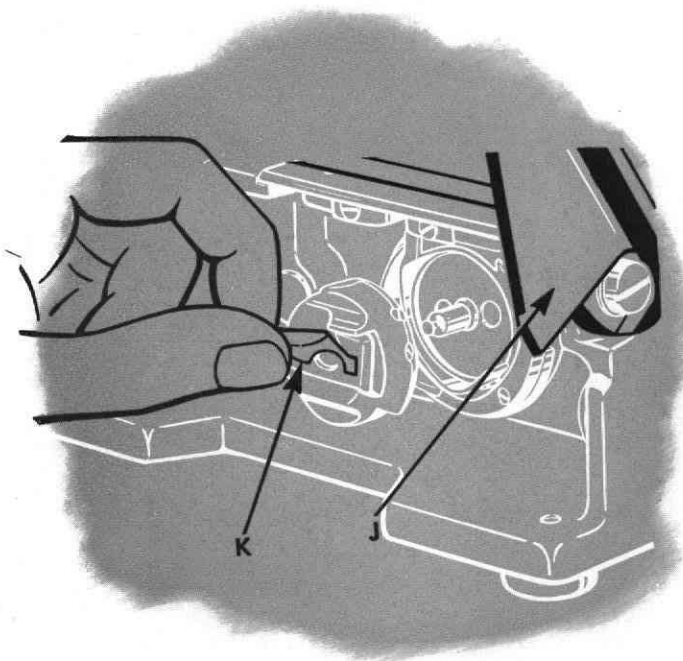

*Fig. 8. Removing the Bobbin Case*

### **TO REMOVE THE BOBBIN**

Raise needle to its highest point.

Raise bed extension **J**. Grasp bobbin case latch **K** and lift out bobbin case. Release latch and remove bobbin.

### **TO WIND THE BOBBIN**

*See Fig. 9 on the following page*

To stop motion of needle, hold hand wheel **L** and loosen knurled screw **M** by turning it over toward you. Lift bobbin winder out of recess and bring its pulley **N** into contact with hub of hand wheel.

Place bobbin on bobbin winder spindle as far as it will go.

Place spool of thread on spool pin **1**.

Draw thread under and between tension discs **2**.

Pass thread through one of the holes in left side of bobbin **3**, from the inside.

Hold end of thread as shown in **Fig. 9** and press controller pedal as for sewing. End of thread must be held until it is broken off.

Allow tension discs to control flow of thread so that it winds on bobbin in uniform, level rows.

The bobbin winder will stop automatically when the bobbin is filled.

Remove bobbin from spindle and return bobbin winder to its recessed position. Tighten knurled screw **M**.

If bobbin does not wind evenly, loosen screw which holds tension bracket **2** in position and move bracket to the left if bobbin winds high on the right; move bracket to the right if bobbin winds high on the left. When bracket is properly centered, thread will wind evenly across bobbin.

If bobbin winds too fully, loosen screw **GG**, **Fig. 10** and move plate **HH**, downward, slightly. To wind more thread on bobbin, move plate **HH**, upward, slightly. Tighten screw **GG**.

Bobbin can be wound while machine is sewing.

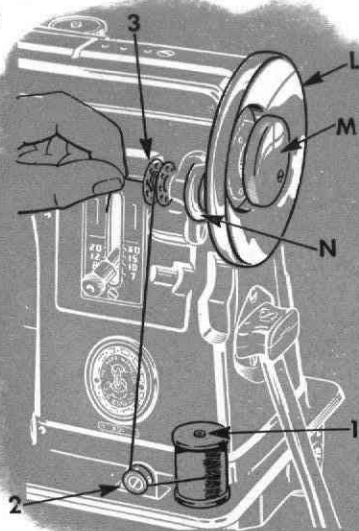

*Fig. 9.*  
*Winding the Bobbin*

*Fig. 10.*  
*Adjustment for*  
*Regulating*  
*Amount of Thread*  
*Wound on Bobbin*

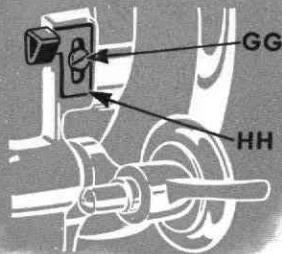
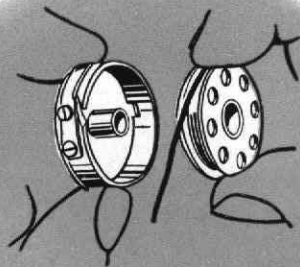

Fig. 11

**TO THREAD BOBBIN CASE**

Hold bobbin so that thread will unwind in direction shown in Fig. 11.

Hold bobbin case as shown in Fig. 11, and place bobbin into it.

Fig. 12

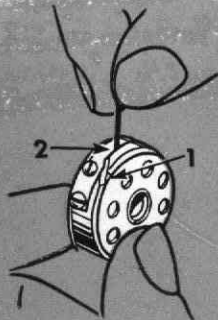
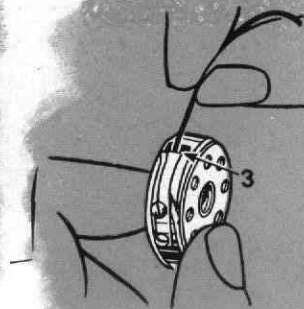

Fig. 13



Pull thread into slot **1**, under tension spring **2** and into slot **3** at end of spring. Allow about three inches of thread to hang free from bobbin case.



## TO REPLACE BOBBIN CASE

Hold bobbin case by latch and place it on stud **Q**, having thread draw from top of bobbin case.

Release latch and press bobbin case back until latch enters groove in stud. Allow about three inches of thread to hang free from bobbin case and turn down bed extension.

### CAUTION:

If throat plate **P** is removed for cleaning stitch forming mechanism, etc., **make certain**, when replacing throat plate, that position finger **R**, Fig. 14 of bobbin case base enters notch **O**, Fig. 14 of position plate attached to underside of throat plate.

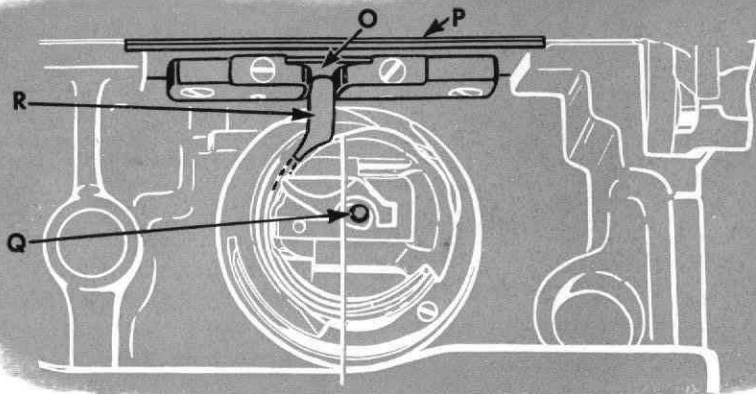
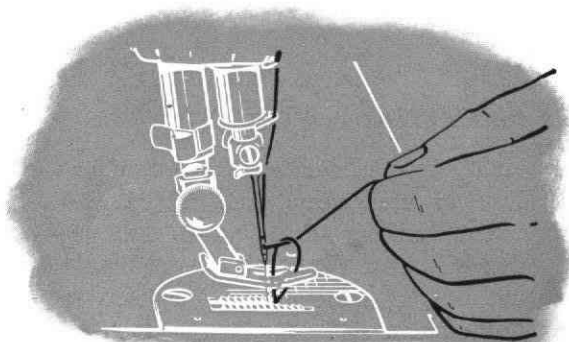

Fig. 14.  
Bobbin Case  
Threaded  
and Replaced

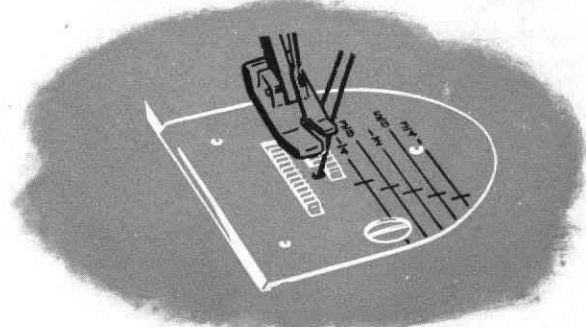

*Fig. 15. Drawing Up Bobbin Thread*

### TO PREPARE FOR SEWING

Hold end of needle thread with left hand and turn hand wheel over toward you until needle goes down and up again and thread take-up lever **S**, **Fig. 17** is at its highest point. Pull up needle thread and bobbin thread will come with it, as shown in **Fig. 15**.

Lay both threads back under the presser foot, diagonally across the feed, as shown in **Fig. 16**, to the right or left, depending upon which side of the needle the material is to be located, so that when the presser foot is lowered, the threads will be firmly held between the feed and the presser foot.



*Fig. 16. Threads in Position to Start Sewing*

**NOTE:** On the throat plate, there are distinct markings to guide the edges of seams and hems. These markings are at  $1/8$ " intervals from  $1/4$ " to  $3/4$ " in distance from the right of the needle, and assist in guiding the fabric uniformly. The crosslines on the throat plate indicate the point at which to pivot on the needle when turning square corners.

## TO START SEWING

Be sure to have thread take-up lever **S** at its highest point.

Place material beneath presser foot **V**, turn hand wheel to bring point of needle into fabric, then lower presser foot by means of presser bar lifter **T** and start to sew. Press controller pedal to start machine. The speed depends upon amount of pressure on controller pedal.

Most materials require only guiding for best sewing results. However, the miracle fabrics such as nylons, dacrons, orlons, blends with various rayons, puffed weaves, sheers, jerseys and tricots, which, by their nature, require light pressure, also require support in the form of holding the material taut at the back and front of the needle as the needle enters the fabric. This support assures a smooth, even seam.

Never pull the material when sewing.

The machine will sew its own thread when sewing from one piece of material to another. However, avoid operating a threaded machine with presser foot up and without fabric under the foot.

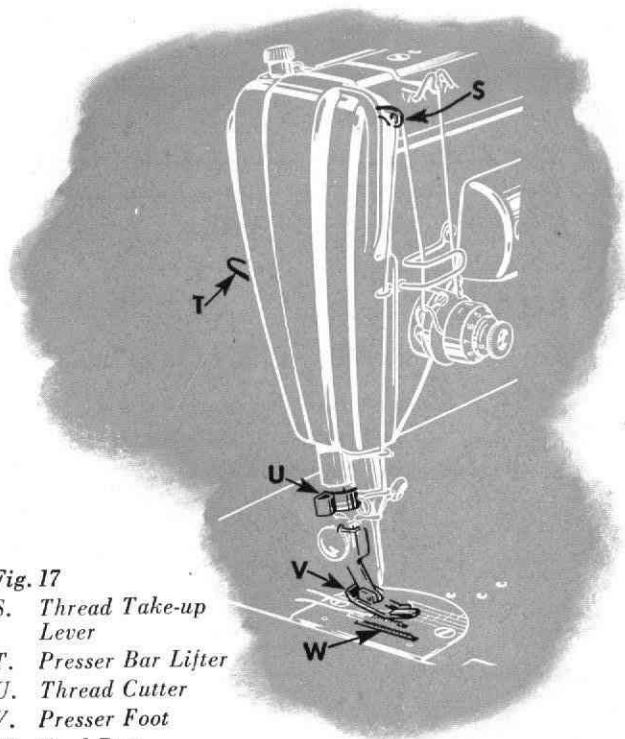

*Fig. 17*

- S. Thread Take-up Lever*
- T. Presser Bar Lifter*
- U. Thread Cutter*
- V. Presser Foot*
- W. Feed Dog*

**TO TURN A CORNER**

Pivot on the eye of the needle. Stop machine when needle is in this position. Raise presser foot and turn work as desired, then lower presser foot and resume sewing.

**BASTING**

Adjust stitch regulator **Y**, **Fig. 18** to make longest stitch.

Machine basting is firmer, more even and much quicker than hand basting.

**TO SEW BIAS SEAMS**

For a smooth bias seam set the stitch regulator between 15 and 20. No change in tensions is required.

**TO REMOVE THE WORK**

Stop machine with thread take-up lever **S**, **Fig. 17** at its highest point.

Raise presser foot, draw fabric back and to left and sever threads on thread cutter **U**, **Fig. 17**.

Place ends of threads under presser foot, as shown in **Fig. 16**.

### TO REGULATE LENGTH OF STITCH

The machine is adjustable to make from 6 to 30 stitches per inch, as indicated by numerals on stitch indicator plate **X**.

To change length of stitch, turn thumb screw on stitch regulator lever **Y**, away from the stitch indicator plate **X**, as far as necessary. Then move the stitch regulator lever until it is in line with the desired number of stitches

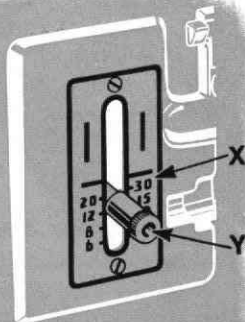

*Fig. 18.*  
Showing Lever for  
Regulating Length  
of Stitch and  
Reversing Direction  
of Feed

to the inch and turn the thumb screw inward **only** until it touches the stitch indicator plate.

The machine will now make the indicated number of stitches to the inch in either a forward or reverse direction, depending on whether the lever **Y** is at its lowest or highest position.

### TO REGULATE DIRECTION OF FEED

To feed the material **from you**, push down the stitch regulator lever **Y**, as far as it will go.

To feed the material **toward you**, raise the stitch regulator lever **Y**, as high as it will go.

The direction of feed can be reversed at any point of a seam without removing work from machine.

The reverse feed makes it easy to "back stitch" and to fasten ends of seams.

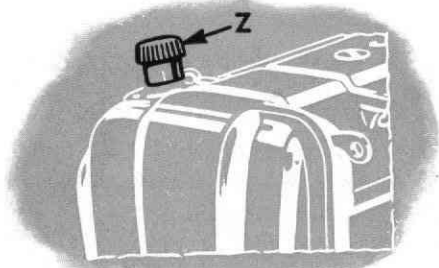

*Fig. 19. Thumb Screw for Regulating Pressure on Presser Foot*



*Fig. 20. Perfect Stitching*



*Fig. 21. Imperfect Stitching*



*Fig. 22. Imperfect Stitching*

### **TO REGULATE PRESSURE ON PRESSER FOOT**

For average materials, the pressure of the presser foot seldom requires changing. Heavy materials require more pressure than lightweight fabrics. The pressure should be only heavy enough to prevent side creeping of material and still obtain a uniform length of stitch. To increase pressure, turn thumb screw **Z** clockwise or downward. To lighten pressure, turn thumb screw so that it screws upward.

### **THREAD TENSIONS**

{ For perfect stitching, the tension on needle and bobbin threads must be heavy enough to pull threads to center of thickness of material and make a firm stitch, as shown in **Fig. 20**.

{ Needle Thread lies straight along top side of material, caused by too heavy tension on needle thread or too light tension on bobbin thread, as shown in **Fig. 21**.

{ Bobbin Thread lies straight along underside of material, caused by too light tension on needle thread or too heavy tension on bobbin thread, as shown in **Fig. 22**.

## TO REGULATE NEEDLE THREAD TENSION

The tension on needle thread can be tested only when presser foot is down.

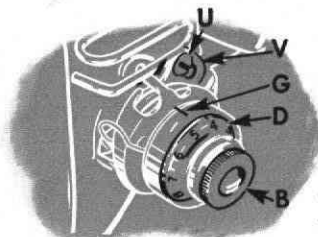

Fig. 23.  
Needle Thread Tension

The numerals "0 to 9" on dial **D**, **Fig. 23** indicate different degrees of tension that can be obtained. The numbers do not denote size of thread or ounces of tension.

When tension has been correctly set as described on **pages 23** and **24**, note number at indicator line **G** so that this setting may be regained should the tension be altered for special work.

**To increase tension**, turn thumb nut **B** gradually to right (clockwise) until required tension is obtained. Each **higher** number denotes increased tension.

The numerals "0 to 9" on dial **D**, **Fig. 23** indicate different degrees of tension that can be obtained. The numbers do not denote size of thread or ounces of tension.

When tension has been correctly set as described on **pages 23** and **24**, note number at indicator line **G** so that this setting may be regained should the tension be altered for special work.

**To decrease tension**, turn thumb nut **B** gradually to left (counter-clockwise) until required tension is obtained. Each **lower** number denotes less tension.

The tension indicator **G** is marked with the signs **+** and **-**, which indicate the direction in which to turn the thumb nut **B** for more or less tension.

## TO REGULATE BOBBIN THREAD TENSION

The tension on bobbin thread is regulated by screw **AA**, **Fig. 24** which is nearest center of tension spring on outside of bobbin case. To increase tension, turn screw **AA** over to right. To decrease tension, turn this screw over to left.

When tension on bobbin thread has been once properly adjusted, it is seldom necessary to change it, as a correct stitch can usually be obtained by varying tension on needle thread.

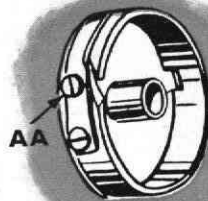

Fig. 24. Bobbin Thread Tension

### TO REMOVE AND DISASSEMBLE NEEDLE THREAD TENSION

Turn thumb nut **B** to left (counter-clockwise) until "O" on numbered dial stops at center line on indicator **G**.

To separate pin **C** in thumb nut **B** from dial **D**, press in dial, unscrew thumb nut and remove it. Then remove dial, stop washer **E**, tension spring **F**, indicator **G** and tension assembly **H**.

**NOTE:** It is not necessary to remove stud **O** from machine to disassemble the thread tension. It is shown removed in **Fig. 25**, only to illustrate the complete assembly.

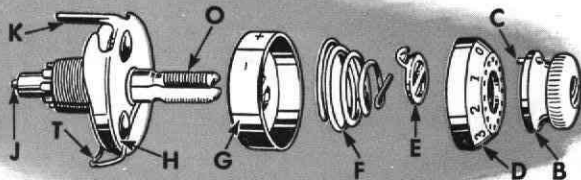

*Fig. 25. Needle Thread Tension Disassembled*

### TO REASSEMBLE AND REPLACE NEEDLE THREAD TENSION

Make sure that tension releasing pin **J** is in place in stud **O**. Place two tension discs **L** with their convex faces together on tension thread guide **M**, then pass eyelet **N** of thread take-up spring under thread guide, having coils of spring above tension discs, as shown in **Fig. 26**.

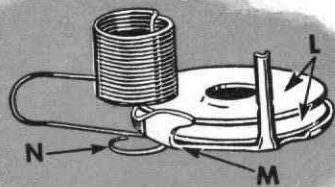
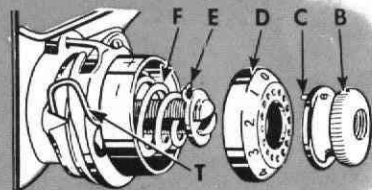

*Fig. 26. Tension Disc Assembly*



Place tension disc assembly on stud **O** so that extension **K** enters hole in machine and tail (inside the coil) of thread take-up spring enters one of grooves in the stud. Next replace indicator **G**, open side out, on stud with plus and minus signs at top and hold parts, thus assembled, against shoulder of stud. Then insert tension spring **F** in indicator with first (half) coil of spring straddling lower half of stud. Place stop washer **E** on stud with extension **S** above stud. If spring and stop washer are in correct position, extension **S** will clear first (half) of tension spring, as shown in **Fig. 28**.

Next, place dial **D** on stud with **No. 2** opposite stop washer extension **S**, then push dial to compress tension spring and at the same time screw thumb nut **B** on stud, inserting pin **C** on nut in one of the holes in dial **D**. Then lower presser bar and turn thumb nut **B** to left until "O" on dial **D** stops at centerline on indicator **G**. Thread the tension and pull thread through tension discs to test amount of tension on thread at the "O" position. At this point there should be a slight pull on the thread to indicate that there is a minimum tension which gradually increases with the turning of thumb nut **B** to the right, providing a full range of tensions with one revolution of the thumb nut.



*Fig. 27. Reassembling Needle Thread Tension*

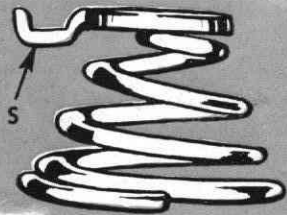

*Fig. 28. Stop Washer and Tension Spring*

If the pull is too strong for a minimum tension, press in dial **D** to disengage pin **C** on nut from dial, and reset pin in one of holes at **left** of previous setting. This resetting will produce less tension at "**O**." Repeat this process until minimum desired tension is obtained.

If there is no tension at "**O**," press in dial **D** and reset pin **C** on nut in one of holes at **right** of previous setting, repeating this process until a slight minimum tension is obtained.

The tension on thread take-up spring **T** and stroke of this spring should be just sufficient to take up slack of needle thread until eye of needle reaches goods in its descent.

To adjust tension on thread take-up spring **T**, remove tension disc assembly, disengage end of spring from groove in tension stud, revolve spring and place its end in the groove which produces correct tension.

For average weights of materials, the stroke of thread take-up spring **T** should release the thread after the needle point has entered the

fabric, i.e., halfway between the point and eye of the needle. To regulate stroke, loosen screw **U**, **Fig. 23** and raise or lower tension thread guide lug **V**, **Fig. 23** until correct stroke is obtained, then tighten screw **U**.

#### **IF CORRECT STITCHING IS NOT OBTAINED**

If bobbin thread tension has been disturbed, or a correct stitch cannot be obtained without a very heavy or very light needle thread tension, the following procedure is recommended.

Using Size 50 Mercerized thread in needle and on bobbin, adjust needle thread tension as instructed on **page 23**. Then turn tension thumb nut until **No. 3** on dial is opposite centerline on indicator and, with two thicknesses of thin material in machine, adjust bobbin thread tension, as instructed on **page 21**, until stitch is correctly locked in material, as shown in **Fig. 20**.

A wide range of materials and threads can now be accommodated without further adjustment of bobbin thread tension.

**SINGER** Needles should be used  
in **SINGER** Machines.  
These Needles and their Containers  
are marked with the  
Company's Trade Mark "SIMANCO."

Needles in Containers marked  
"FOR SINGER MACHINES"  
are NOT **SINGER** made Needles.

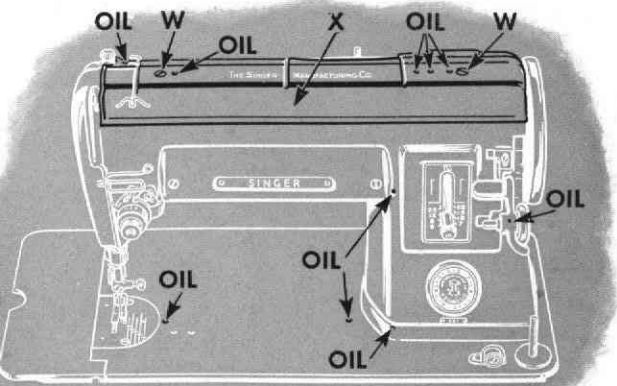

Fig. 29. Front View, Showing Oiling Points

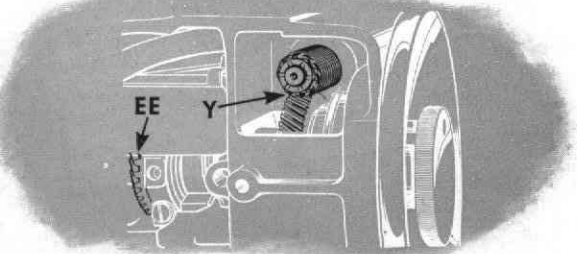

Fig. 30. Lubricating Points for Spiral Gears in Top of Machine

## TO OIL THE MACHINE

If the machine is used continuously, it should be oiled daily. If moderately used, an occasional oiling is sufficient.

Apply one drop of oil at each of the places indicated by arrows in **Figs. 29, 31, 32** and **33**.

### To Lubricate Spiral Gears

About once a year, take out two screws **W**, **Fig. 29**, remove cover **X**, **Fig. 29** and apply a small quantity of **SINGER MOTOR LUBRICANT** to spiral gears **Y** and **EE**, **Fig. 30**, then replace cover **X** and fasten as before with screws **W**.

**Never apply oil to these gears.**

Swing face plate to left and oil the places indicated by arrows in **Fig. 31**, then close face plate.

### ***To Oil Sewing Hook***

Occasionally apply a drop of oil to bobbin case base bearing in sewing hook indicated in **Fig. 32**.

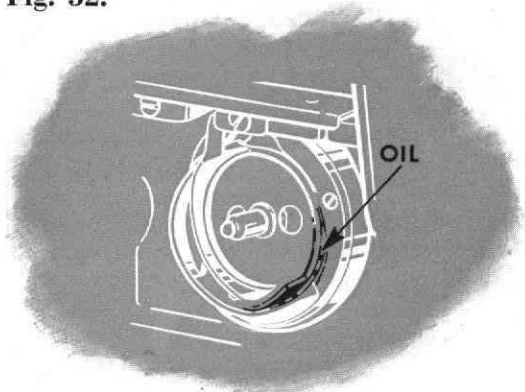

*Fig. 32. Oiling Point in Sewing Hook*

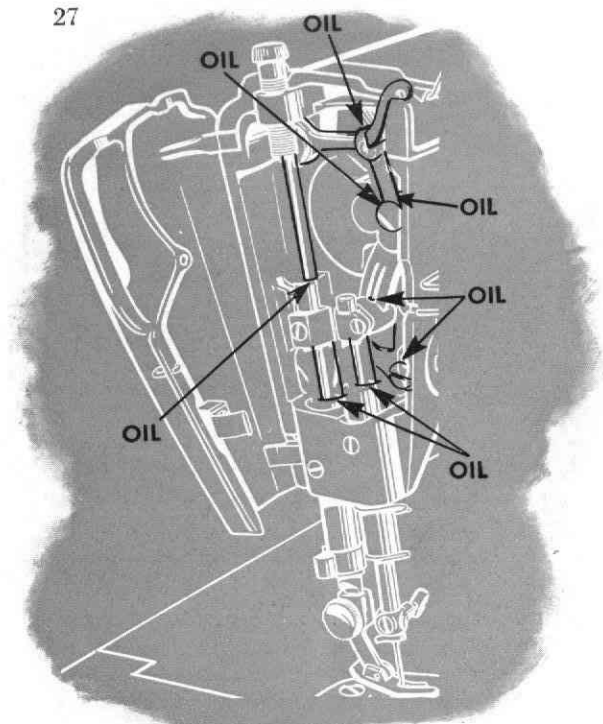

*Fig. 31. Face Plate Opened Showing Oiling Points*

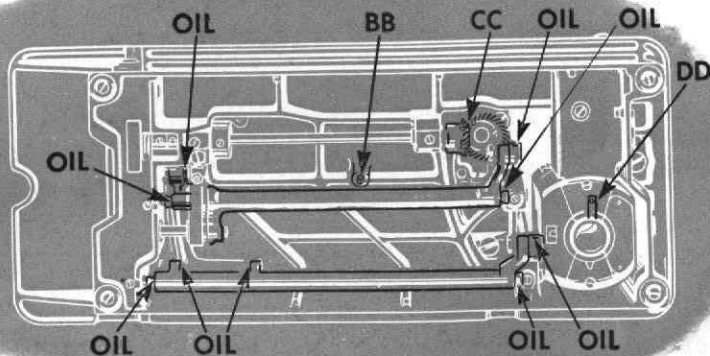

*Fig. 33. Oiling Points in Base of Machine  
Also Showing Motor Grease Tube (DD)*

Remove machine from cabinet as instructed on **page 6**, and then turn machine over on its rear side. Remove thumb nut from screw **BB**, **Fig. 33** being careful not to lose felt washer, and remove large cover from underside of bed. Oil each of places indicated by arrows in **Fig. 33**, and occasionally apply a small quantity of **SINGER MOTOR LUBRICANT** to teeth of

gears **CC**, then replace cover and felt washer and fasten as before with thumb nut (not too tightly).

#### **TO LUBRICATE THE MOTOR**

**NEVER USE OIL OR ORDINARY GREASE FOR LUBRICATING THE MOTOR** as they are harmful for this purpose. **USE ONLY SINGER MOTOR**

**LUBRICANT** from tube supplied with machine. It is the only lubricant which will positively lubricate the motor.

When machine is shipped from factory, the motor grease tube **DD**, **Fig. 33** is filled for approximately six months' use.

Refill grease tube **DD** at least once each six months. Insert the tip of lubricant container into grease tube and squeeze enough grease into tube to fill it. Replace cover on bottom of machine.

**SEWING SUGGESTIONS*****Breaking of Needles Might be Caused by:***

1. Improper Size of Needle for Thread and Material—See **Page 64**.
2. Needle Bent.
3. Pulling of Material when Stitching.
4. Needle Striking Improperly Fastened Presser Foot or Attachments.
5. Crossing Too Thick Seams with Too Small a Needle.

***Breaking of Needle Thread Might be Caused by:***

1. A Knot in Thread.
2. Improper Threading—See **Page 11**.
3. Upper Tension Too Tight—See **Page 21**.
4. Needle not pushed up as far as it will go into needle clamp—See **Page 9**.
5. Needle Blunt or Bent.
6. Thread Too Coarse for Needle—See **Page 64**.

7. Roughened Hole in Throat Plate.

8. Improper Arrangement of Thread to Commence Sewing—See **Page 16**.

***Breaking of Bobbin Thread Might be Caused by:***

1. Improper Threading of Bobbin Case—See **Page 14**.
2. Bobbin Thread Tension Too Tight—See **Page 21**.

***Skipping of Stitches Might be Caused by:***

1. Needle not pushed up as far as it will go into needle clamp—See **Page 9**.
2. Needle Blunt or Bent.
3. Needle Too Small for Thread—See **Page 64**.

**If Machine Runs Heavily** after standing idle for a long period, apply a few drops of kerosene at all oiling places, run machine for a few minutes, then wipe clean and oil—See **Pages 26, 27 and 28**.

Remove the presser foot of your sewing machine, and lower the feed. The design to be followed may be stamped or marked on the right or wrong side of the fabric, according

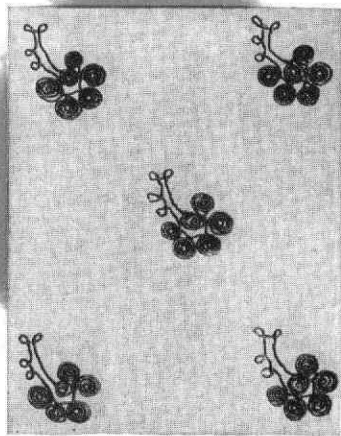

#### CORDONNET STITCH

**Threads:**  
 Bobbin—"Cordonnet," a fine silk gimp thread.  
 Needle—Size A, silk of matching color.  
**Tensions:**  
 Bobbin—Loosen  $\frac{1}{8}$  to  $\frac{1}{4}$  turn of screw from normal.  
 Needle Thread—Tighten 1 to 2 points.  
**Needle:**  
 Size 14 to accommodate size A silk.  
 Trace design on wrong side of fabric. Work from center to edge of each circular motif.

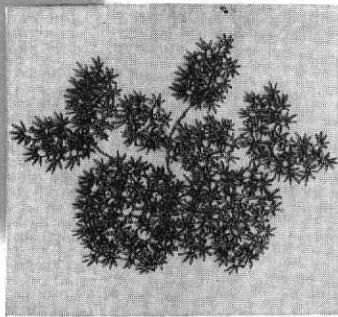

#### SPARK STITCH

**Threads:**  
 Both **Needle** and **Bobbin** carry regular sewing thread; size A silk or mercerized thread in sizes 50, 00 or 000.  
**Tensions:**  
 Bobbin—Loosen  $\frac{1}{4}$  to  $\frac{1}{2}$  turn of screw from normal.  
 Needle Thread—Tighten 3 to 4 points.  
**Needle:**  
 Size 11 or 14 to accommodate needle thread.  
 Trace design on right side of fabric. Hoops are moved in circles resulting in bobbin thread being drawn through the fabric in radiating sparks for outlining or filling a design.

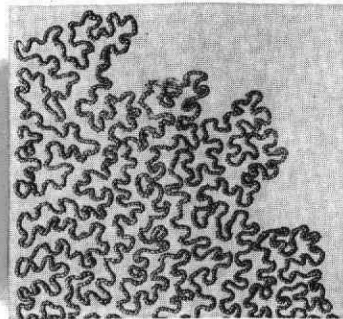

#### METALLIC STITCH

**Threads:**  
 Bobbin—Fine metallic gimp thread.  
 Needle—Size A, silk of matching color.  
**Tensions:**  
 Bobbin—Loosen slightly from normal.  
 Needle Thread—Tighten one to two points.  
**Needle:**  
 Size 14 to accommodate Size A silk.  
 Trace design on wrong side of fabric, or follow free hand heel and toe pattern.



## WITHOUT ATTACHMENTS

to the stitch chosen. Place the work in embroidery hoops, lower the presser bar, and follow the design with the sewing machine needle. Visit your local SINGER SEWING CENTER for further help and advice.

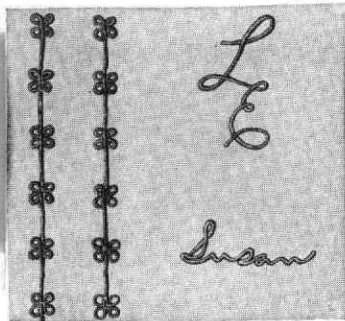

**SIGNATURE STITCH**

**Threads:**

Both **Bobbin** and **Needle** carry regular sewing thread; size A silk or mercerized thread in sizes 50, 00 or 000.

**Tensions:**

**Bobbin**—Loosen  $\frac{1}{4}$  to  $\frac{1}{2}$  turn of screw from normal.

**Needle Thread**—Tighten 2 to 3 points.

**Needle:**

Size 11 or 14 to accommodate needle thread.

Trace design on right side of fabric. Operate machine at moderate speed while moving hoops very slowly so that the bobbin thread completely covers the needle thread in a gimp-like fashion.

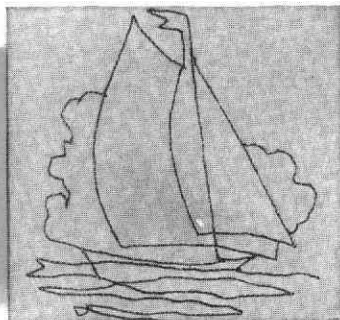

**ETCHING STITCH**

**Threads:**

Both **Bobbin** and **Needle** carry regular sewing threads.

**Tensions:**

Regulate to form an evenly locked stitch as in regular sewing.

**Needle:**

Selected to accommodate the needle thread.

Trace design on right side of fabric. Operate the machine at a moderate and uniform speed, while coordinating with it the even movement of the hoops to produce short, regular stitching.

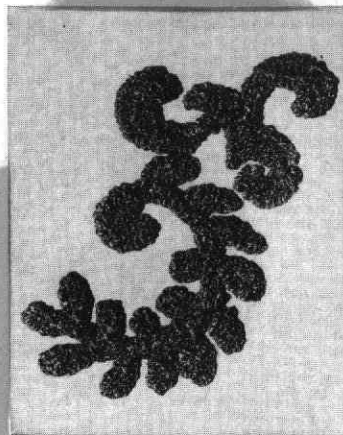

**BOUCLÉ STITCH**

**Threads:**

**Bobbin**—Pearl Cotton #8, single and 2-ply yarns and similar threads.

**Needle**—Size A, silk, or size 50 mercerized thread.

**Tensions:**

**Bobbin**—Loosen  $\frac{1}{2}$  to  $\frac{3}{4}$  turn of screw from normal.

**Needle Thread**—Tighten 1 to 2 points.

**Needle:**

Size 14 to accommodate needle thread.

Trace design on wrong side of fabric. The Bouclé Stitch is always a series of small circles placed closely together to produce a nubby textured solid design. An underlay of orgrandy is often used on jersey or crepe fabrics.

PRESSURE REGULATING  
THUMB SCREW

THREAD TAKE-UP LEVER

FACE PLATE

PRESSER BAR LIFTER

THREAD TAKE-UP SPRING

NEEDLE THREAD TENSION

TENSION REGULATING  
THUMB NUT

PRESSER BAR

THREAD CUTTER

PRESSER FOOT  
THUMB SCREW

PRESSER FOOT

FEED DOG

THROAT PLATE

BED EXTENSION

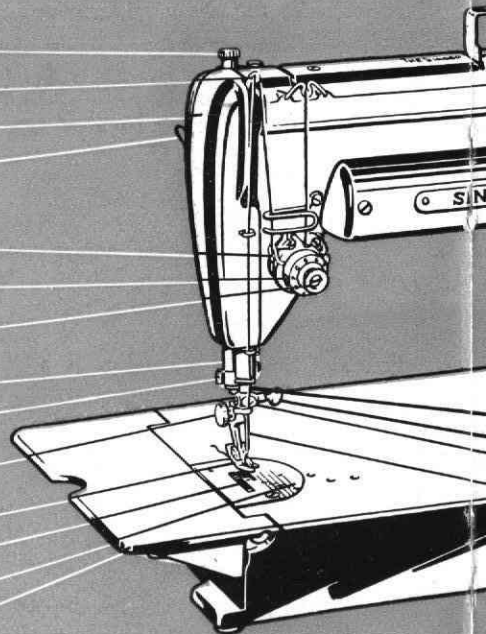

NAMES OF PRINCIPAL P

*Fig. 34*

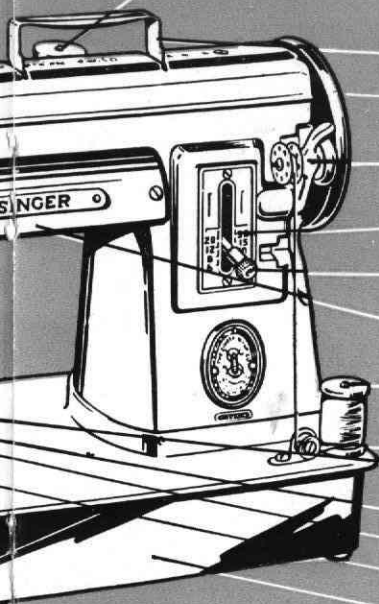

SPOOL PIN

HANDLE

HAND WHEEL

BOBBIN WINDER

STITCH INDICATOR

STITCH REGULATOR AND  
FEED REVERSING LEVER

SINGERLIGHT

BOBBIN WINDER  
SPOOL PINBOBBIN WINDER  
THREAD TENSION

NEEDLE BAR

NEEDLE CLAMP  
THUMB SCREW

NEEDLE CLAMP

NEEDLE

BED

PARTS OF MACHINE 301

## INSTRUCTIONS FOR USING ATTACHMENTS

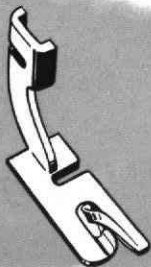

*Fig. 35. Foot Hemmer*

### **THE FOOT HEMMER**

The foot hemmer may be used for hemming edge of material, making hemmed and felled seams and for hemming and sewing on lace in one operation.

#### ***To Attach Foot Hemmer***

Raise needle to its highest point, remove presser foot and attach foot hemmer to presser bar in place of presser foot.

Pull up bobbin thread as instructed on **page 16**.

1. Fold edge of material twice, about  $\frac{1}{8}$  inch each time, for a distance of about two inches. Crease folds.

2. Lay about three inches of needle and bobbin threads back under hemmer. Place creased edge of material under hemmer with end of hem directly under needle. Lower hemmer and tack end of hem with two machine stitches.

3. Raise hemmer. Pull threads and hem slightly from you with left hand, then while holding threads, draw material toward you with right hand into scroll of hemmer until tacked end is caught in hemmer, as shown in **Fig. 36**.

4. Lower hemmer and commence to sew, slightly pulling threads back while sewing. **Keep mouth of hemmer full to produce a smooth, even hem, as shown in Fig. 37.**

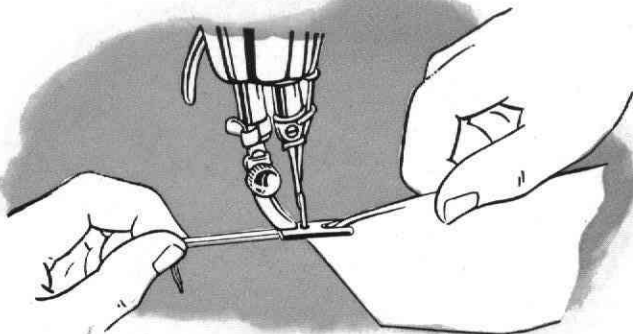

*Fig. 36. Starting Hem at Very End of Material*

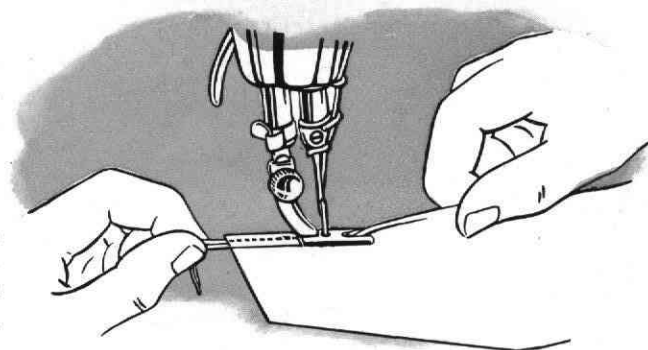

*Fig. 37. Hemming Edge of Material and Pulling Back Threads While Sewing*

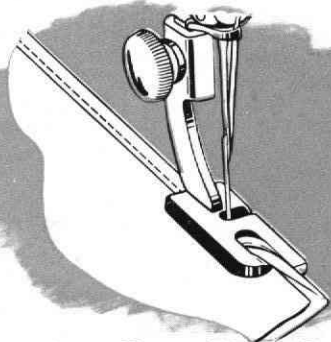

*Fig. 38. Making a Hemmed Seam (First Operation)*

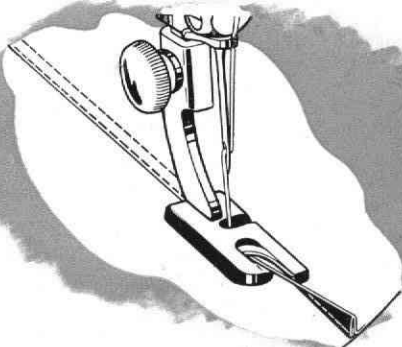

*Fig. 39. Making a Hemmed Seam (Second Operation)*

### **TO MAKE A HEMMED SEAM WITH FOOT HEMMER**

1. When making this seam, the garment must first be fitted and edge of material trimmed, allowing for about  $\frac{1}{8}$  inch seam. Insert the two edges of material, right sides together, in hemmer in same manner as a single hem as shown in **Fig. 38**. If material is bulky, place edge of upper piece of material about  $\frac{1}{8}$  inch to left of edge of under piece.

2. The free edge of hemmed seam may be stitched flat to garment, if desired. To do this, open work out flat, wrong side up, then insert hem in scroll of hemmer, holding edge of hem in position while it is being stitched. If seam is stitched flat to garment, one row of stitching is visible on the right side.

**TO MAKE A FELLED SEAM  
WITH FOOT HEMMER**

1. Place right sides of material together, having edge of upper piece about  $\frac{1}{8}$  inch to left of edge of under piece. Stitch the two pieces together, using hemmer as a presser foot. Guide both pieces by the projecting toe of hemmer, as shown in **Fig. 40**.

2. Open work out flat, wrong side up, and hem free edge of seam, stitching it flat to garment as shown in **Fig. 41**.

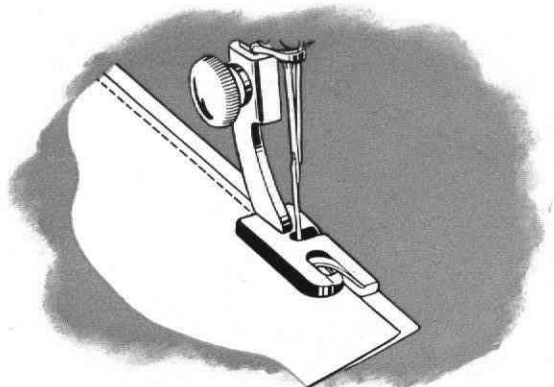

*Fig. 40. Making a Felled Seam (First Operation)*

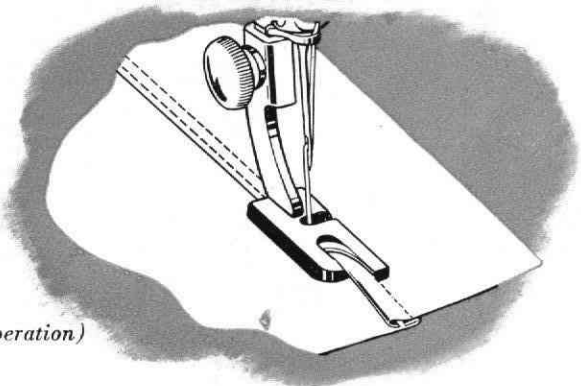

*Fig. 41. Making a Felled Seam (Second Operation)*

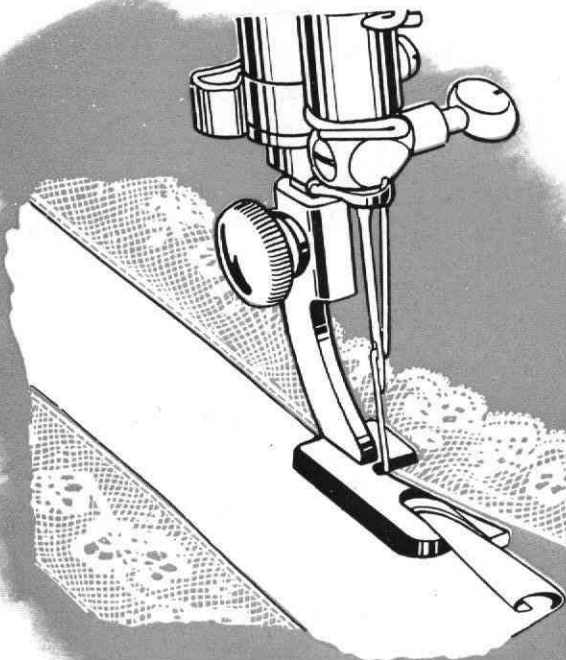

**TO HEM AND SEW ON LACE  
IN ONE OPERATION**

1. Start hem in the regular way.
2. Hold hem in position with needle.
3. Raise presser bar and insert edge of lace in slot of hemmer and back under hemmer.
4. Lower presser bar and commence sewing, catching edge of lace with needle.
5. Guide hem with right hand and lace with the left, being careful not to stretch lace as it enters hemmer.

*Fig. 42. Hemming and Sewing on Lace*



### ADJUSTABLE HEMMER

#### *To Make Hems from 3/16 to 15/16 Inch Wide*

1. Attach adjustable hemmer to presser bar in place of presser foot.
2. Pull up bobbin thread, as instructed on page 16.
3. Loosen thumb screw on hemmer and move scale until pointer registers with number of desired width of hem, **No. 1** indicating narrowest hem and **No. 8**, the widest, then tighten thumb screw.
4. Place cloth in hemmer and draw it back and forth until hem is formed, as shown in **Fig. 43**.
5. Draw end of hem back under needle, lower presser bar and commence to sew.
6. Guide sufficient cloth into hemmer to turn hem properly.

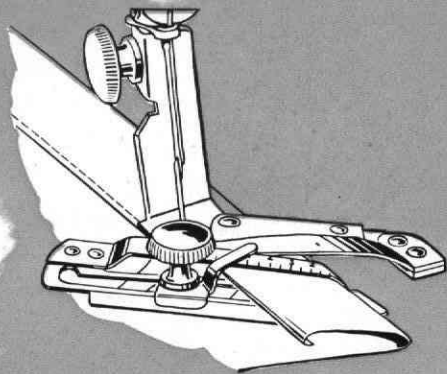

*Fig. 43. Showing How Adjustable Hemmer is Used for Making Hems up to 15/16 Inch Wide*

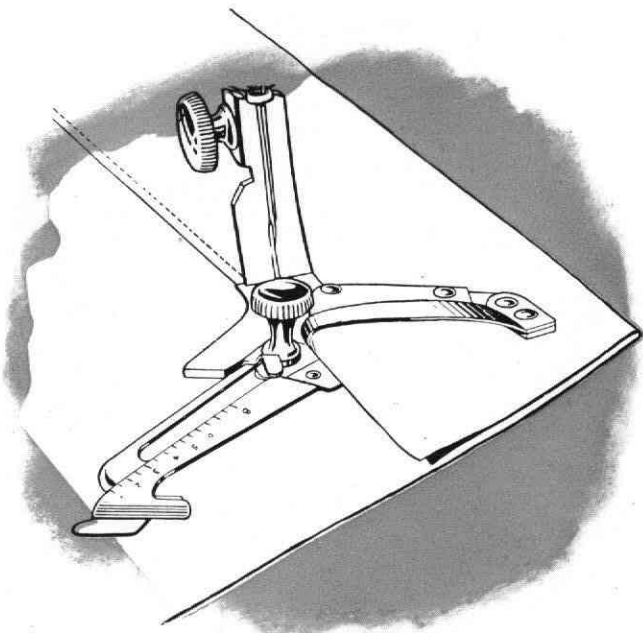

### ADJUSTABLE HEMMER

#### *To Make Hems Wider than 15/16 Inch*

1. Loosen thumb screw on hemmer, move scale to right as far as it will go, then swing it toward you, as shown in **Fig. 44**, and tighten thumb screw.
2. Fold and crease desired width of hem.
3. Place fold under extension at right of hemmer and edge into folder, as shown in **Fig. 44**.
4. Draw end of hem back under needle, lower presser bar and commence to sew.
5. Guide cloth to keep hem flat.

*Fig. 44. Showing How Adjustable Hemmer is Used for Making Hems Wider than 15/16 Inch*

### MULTI-SLOTTED BINDER

The multi-slotted binder will apply **unfolded bias binding 15/16 inch** in width and commercial **folded binding** in sizes **1, 2, 3, 4** and **5** to the seams or to the edges of garments. These sizes of folded binding are **1/4, 5/16, 3/8, 7/16** and **1/2 inch** in width, respectively, and are fed through slots of corresponding sizes in the binder scroll. See **Fig. 45**. Binding may be purchased in a variety of materials and colors.

For convenience in determining the correct width of **unfolded binding (15/16 inch)**, this measurement is marked on the binder, as shown in **Fig. 45**.

The two upright guide pins shown in **Fig. 45** eliminate manual guiding of the binding.

The wide range of bindings that can be applied with this binder makes it useful for a large

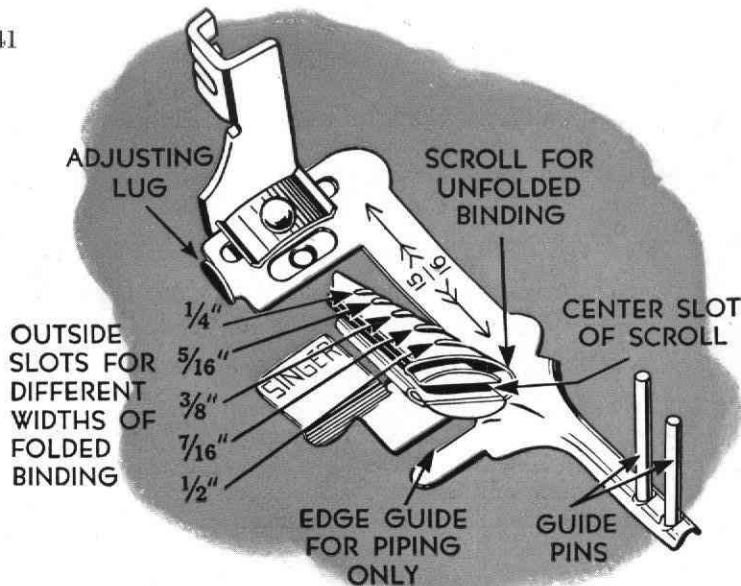

*Fig. 45. Multi-Slotted Binder 160624*

variety of work. It will be found particularly advantageous for making children's wear, lingerie, summer dresses, and other dainty articles which call for the narrower bindings.

As two different widths of binding of contrasting color can be fed through the binder at the same time, attractive binding and piping effects can be produced in one operation.

#### **TO ATTACH THE BINDER**

Raise needle to its highest position, then attach binder to presser bar in place of presser foot.

See that needle enters center of needle hole.

**CAUTION:** When this binder is used, do not raise hinged extension of cloth plate high enough to strike binder, as this would tend to distort and damage binder. Before storing machine, binder must be removed to avoid damage.

#### **TO INSERT BINDING IN BINDER**

Cut all binding to a long point to the left, as shown in **Fig. 46**.

**Folded Bias Binding** must be inserted in slot or slots of corresponding sizes. See **Fig. 49**.

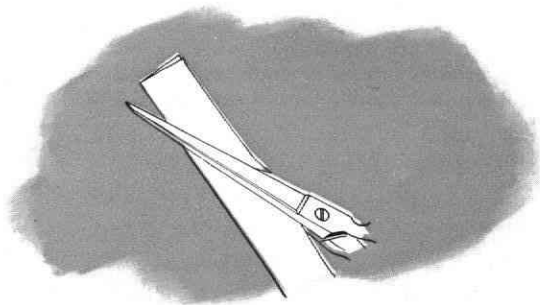

*Fig. 46*

**Unfolded or Raw Edge Bias Binding** must be inserted in open end of scroll. See **Fig. 47**.

After inserting pointed end of binding in binder, push it through until full width of binding is under needle.

Guide binding by means of two upright pins, as shown in **Figs. 47 and 49**.

### TO INSERT GARMENT IN BINDER

Place edge to be bound as far to the right as it will go in center slot of scroll, as shown in **Fig. 47**, and draw it back under binder foot.

Lower binder by means of presser foot lifter and commence to sew. Keep material well within center slot of scroll so that edge will be caught in binding.

### TO ADJUST BINDER

To bring the inner edge of the binding closer to stitching, move scroll **C2**, **Fig. 47** to right by means of lug **B2**, **Fig. 47**. This is the usual adjustment when binding straight edges.

When binding curves, move scroll to left to bring inner edge of binding farther from stitching and allow for sweep of curve.

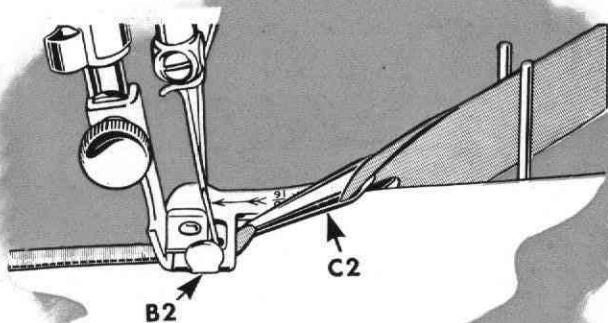

*Fig. 47. Binding with Unfolded Bias Binding*

**PIPED EDGE**

To produce a **pip ed edge** on garments, move lug **B2**, **Fig. 48** to left to bring stitching about midway of folded binding.

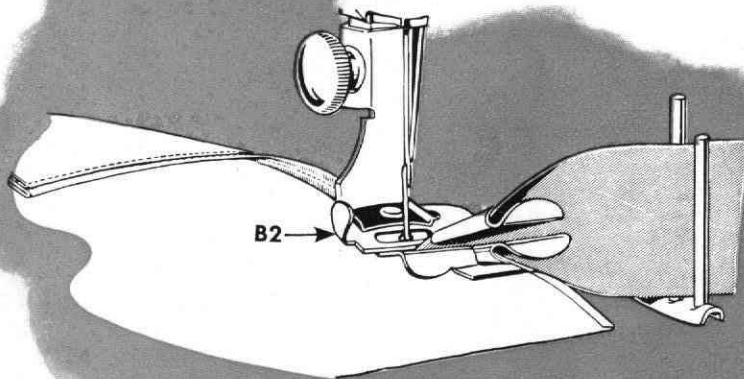

Crease raw edges of garment toward wrong side about 1/8 inch, and insert folded edge, raw edges uppermost, into edge guide on binder and **beneath** binding.

When stitched, both sides of garment will be finished, and right side will show pip ed edge.

*Fig. 48. Positions of Garment and Binding when Piping Edges*

### PIPING AND BINDING IN ONE OPERATION

A garment can be piped and bound in one operation, as shown in **Fig. 49**.

**IMPORTANT:** When piping and binding at the same time, as shown above, insert **narrower width** of binding **first** in its slot, then insert **wider width** in its slot. **Two consecutive widths should not be used at the same time.** That is, if No. 1 is used, the wider binding should not be smaller than No. 3. If No. 2 is used, the wider binding should not be less than No. 4. **Never use Nos. 1 and 2, or 2 and 3, etc., together.**

Use upright guide pins to guide the wider of the two widths of binding as shown in **Fig. 49**.

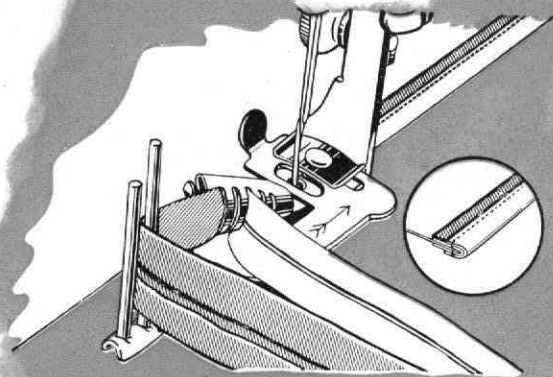

*Fig. 49. Piping and Binding in One Operation*

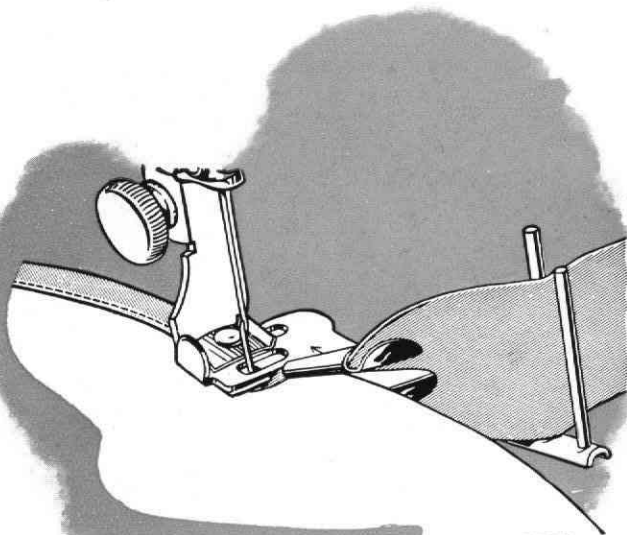

*Fig. 50. Binding on Outside Curve*

### **TO BIND OUTSIDE CURVES**

Allow edge to be bound to pass freely through scroll without crowding against scroll wall. The material must be guided from back of binder and to left, permitting unfinished edges to swing naturally into scroll of binder.

Never pull binding while it is being fed through binder, as this may stretch binding, making it too narrow to stitch or to turn in edges.

When binding curves, turn material only as fast as machine sews.

Do not push material in too fast as this will pucker the edge.

Do not stretch material as this will distort edge so that curve will not have proper shape when finished.

If stitching does not catch edge of binding, adjust scroll slightly to left.



### TO BIND INSIDE CURVES

When binding an inside curve, straighten out inside edge of material while feeding it into binder, being careful not to stretch material.

Soft materials like batiste or crepe de chine require a row of stitching added close to edge of curve before binding.

### TO APPLY FRENCH FOLDS TO CURVES

Place material under binder and stitch binding onto face of material, as shown in **Fig. 51**.

For guidance in applying rows of French folds, mark material with a line of basting stitches or with chalk or pencil.

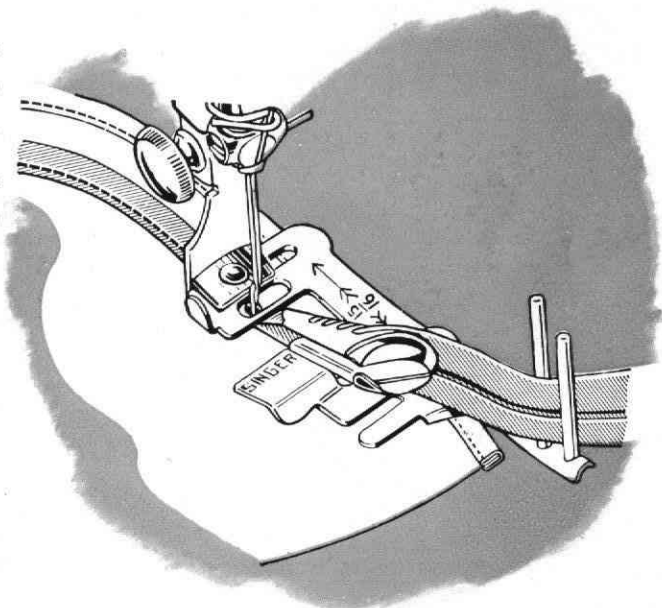

*Fig. 51. Applying a French Fold*

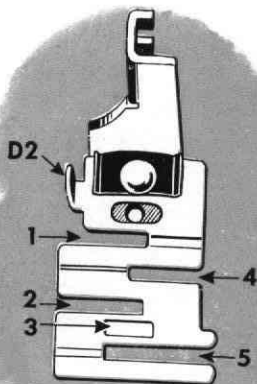

Fig. 52. The Edge Stitcher

### THE EDGE STITCHER

This attachment should be used when the stitching must be kept accurately on extreme edge of material. It is also useful for sewing together laces, insertions and embroideries, sewing in position hemmed or folded edges, piping or sewing flat braid to a garment.

#### *To Adjust the Edge Stitcher*

Fasten this attachment to presser bar in place of presser foot. See that needle enters center of needle hole. The distance from line of stitching to edge of material in slots is regulated by moving lug **D2**, **Fig. 52** to right or left.

#### *To Sew Lace Together*

1. Insert one of laces in slot **1** of edge stitcher and the other in slot **4**, **Fig. 52**.
2. Adjust lug **D2** until edges to be joined are caught by stitching.
3. Slightly overlap edges of lace while stitching to keep them against ends of slots.
4. Loosen both thread tensions to avoid puckering of fine lace.

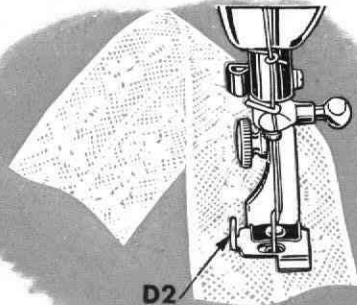
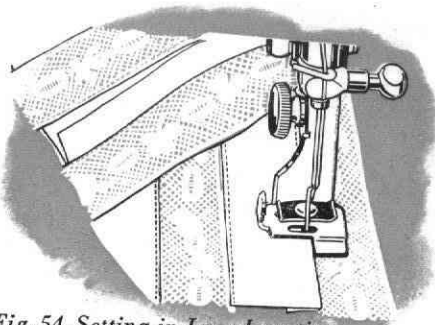

Fig. 53. Sewing Lace Together

### ***To Insert Lace or Ribbon***

1. Fold edge of material to which lace or ribbon is to be sewn and insert it in slot **1** of edge stitcher.
2. Insert lace or ribbon in slot **4** of edge stitcher and proceed to sew.
3. Cut away surplus folded material close to stitching.



*Fig. 54. Setting in Lace Insertion*

### ***To Pipe with Edge Stitcher***

1. Cut piping bias and twice width of slot **3** so that it can be folded once.
2. Insert piping with its folded edge to left in slot **3** and edge to be piped in slot **4**, **Fig. 52**.

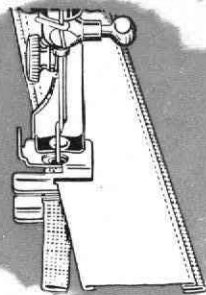

*Fig. 55. Piping with the Edge Stitcher*

### ***To Apply Folded Bias Tape or Military Braid***

1. Place garment under edge stitcher and tape in slot **1** or **4**, **Fig. 52**.
2. To make square corners, sew to turning point, remove tape from attachment, form corner by hand, replace tape and continue stitching.
3. To space two or more parallel rows, mark material with a guide line, using a crease, chalk or basting thread.

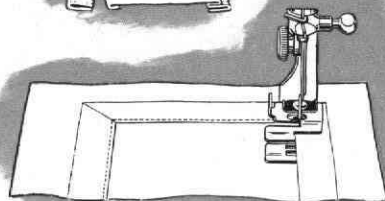

*Fig. 56. Applying Bias Folded Tape*

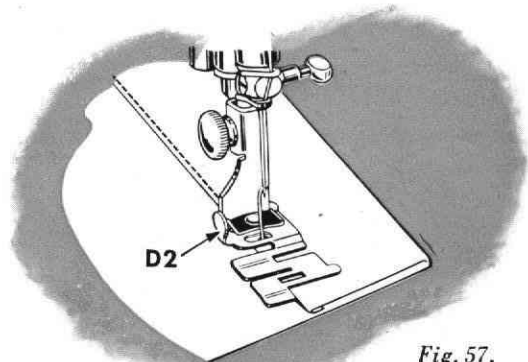

*Fig. 57.  
Making a Wide Hem*

### ***To Stitch a Wide Hem***

1. A wide hem may be stitched evenly on sheets, pillow slips, etc., with edge stitcher after hem has been measured and the edge turned.
2. Insert the edge in slot **5**, **Fig. 52**, and adjust lug **D2** to stitch as close to the edge as desired.

### ***To Make a French Seam***

1. To make a uniform width French seam, insert two edges to be joined, wrong sides together, in slot **1** or **2** and stitch close to edge.
2. Fold both right sides together and insert back of seam in slot **1** and stitch, allowing just enough margin to conceal raw edges.

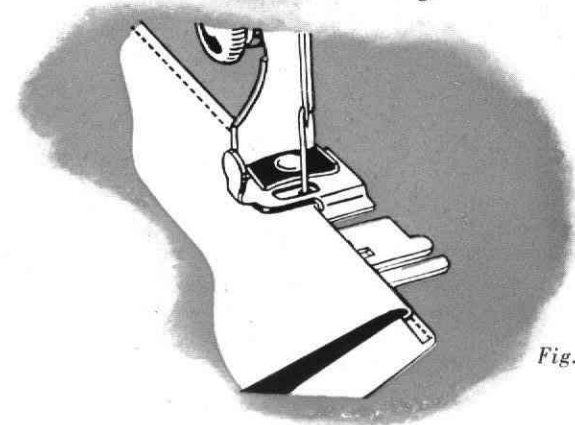
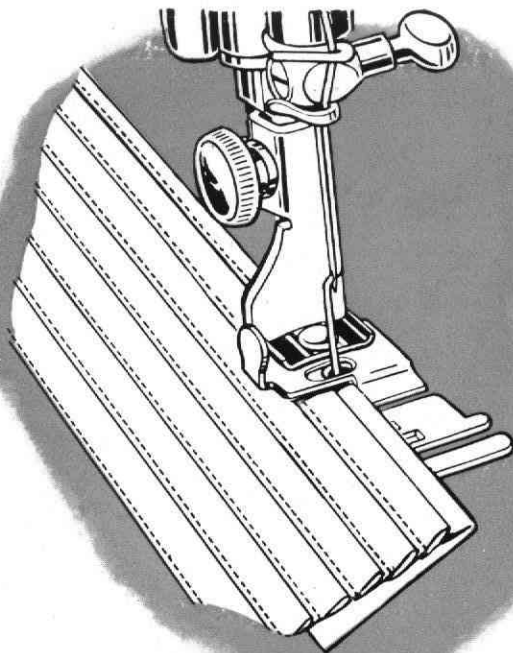

*Fig. 58. Making a French Seam*

### ***To Tuck with Edge Stitcher***

The maximum width of tuck that can be made with edge stitcher is  $\frac{1}{8}$  inch.

1. Fold and crease material for desired width of tuck.
2. For succeeding tucks, fold material desired distance from previous tuck, running fold lengthwise over a straight edge, then crease folds.
3. Insert creased folds in slot 1 and adjust edge stitcher to right or left for desired width of tuck. Use a light tension, short stitch and fine thread and needle.



*Fig. 59. Tucking with Edge Stitcher*

**GATHERING FOOT*****To Shirr with Gathering Foot***

1. Fasten gathering foot to presser bar in place of presser foot.
2. Place material under gathering foot and stitch in usual way.
3. The fullness of shirring or amount of gathering is regulated by length of stitch. A longer stitch increases fullness of gathers.

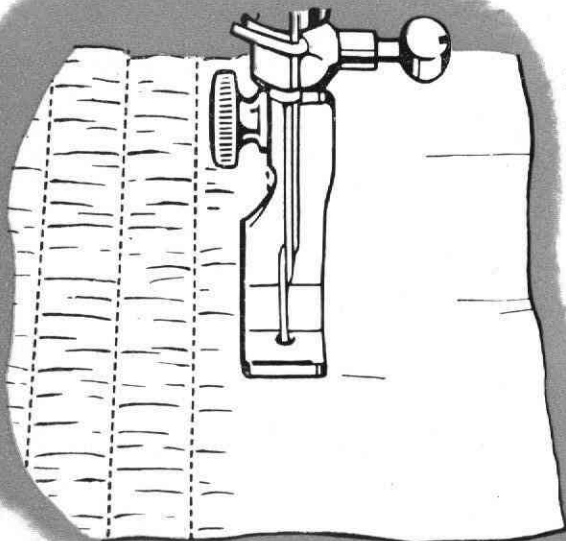

*Fig. 60. Shirring with Gathering Foot*

### PRINCIPAL PARTS OF RUFFLER

**A—Foot**—attaches ruffler to presser bar.

**B—Fork Arm**—straddles needle clamp.

**C—Adjusting Screw**—regulates fullness of gathers.

**D—Projection**—engages slots in adjusting lever.

**E—Adjusting Lever**—sets ruffler for gathering or for making a plait once at every six stitches or once every twelve stitches, as desired; also for disengaging ruffler, when either plaiting or gathering is not desired.

**F—Adjusting Finger**—regulates width or size of plaits.

**G—Separator Guide**—contains slots into which edge of material is placed to keep heading of ruffle even; also for separating material to be ruffled from material to which ruffle is to be attached.

**H—Ruffling Blade**—pushes material in plaits up to the needle.

**J—Separator Blade**—prevents teeth of ruffling blade coming into contact with feed of machine or material to which ruffle or plaiting is to be applied.

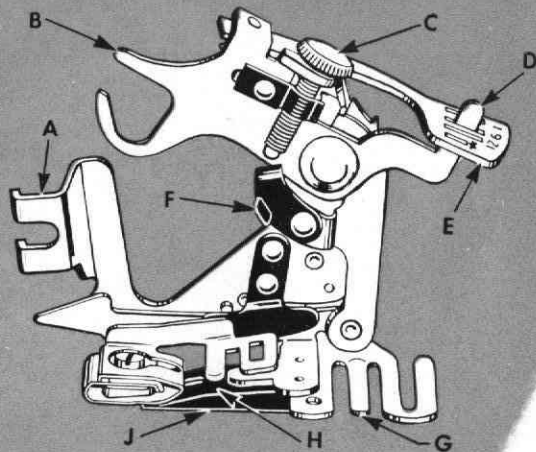

*Fig. 61. Principal Parts of Ruffler*

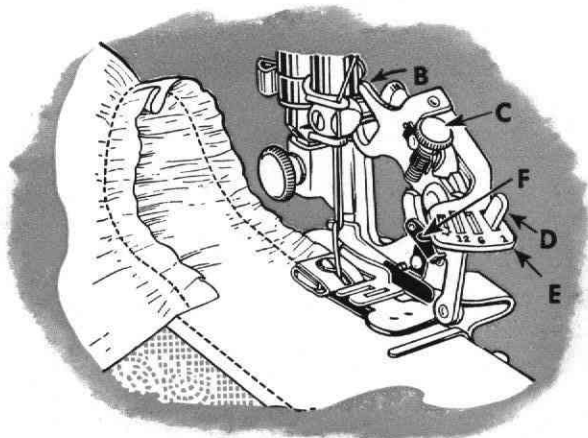

Fig. 62. Gathering with Ruffler

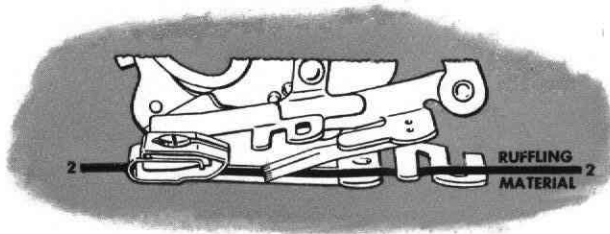

Fig. 63. Correct Position for Material to be Ruffled

### **To Attach Ruffler**

1. Raise needle to its highest point.
2. Loosen presser foot thumb screw and attach ruffler to presser bar in place of presser foot, at the same time placing fork arm B astride needle clamp.
3. See that needle enters center of needle hole in ruffler.

### **To Adjust Ruffler for Gathering**

1. Swing adjusting finger F away from needle.
2. Raise adjusting lever E and move it until projection D can be entered in slot marked "1."
3. Insert material to be ruffled between two blue blades and under separator guide (**Line 2, Fig. 63**).
4. Draw material slightly back of needle, lower presser bar and commence to sew.
5. For fine gathering, turn adjusting screw C upward to shorten stroke. Set the machine for a shorter stitch.
6. For full gathering, turn adjusting screw C downward to lengthen stroke. Set the machine for a longer stitch.



***To Make a Ruffle and Sew it to a Garment in One Operation***

1. Insert material to be ruffled between two blue blades and under separator guide (**Line 2, Fig. 64**).
2. Place material to which ruffle is to be attached under separator blade and under separator guide (**Line 1, Fig. 64**).
3. Proceed the same as for plain gathering.

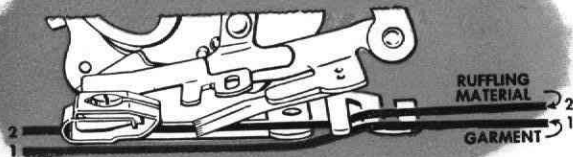

*Fig. 64. Correct Positions for Materials*

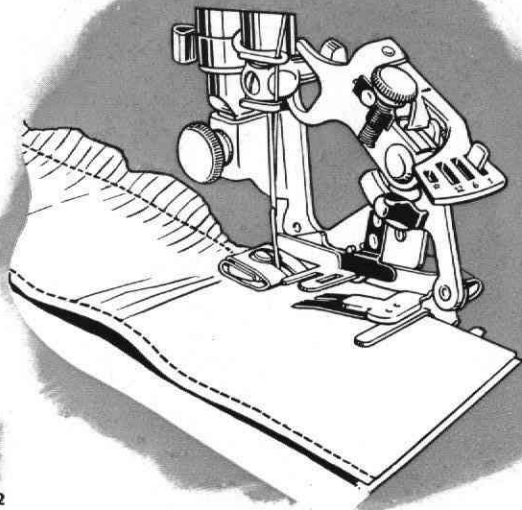

*Fig. 65. Making a Ruffle and Attaching it in One Operation*

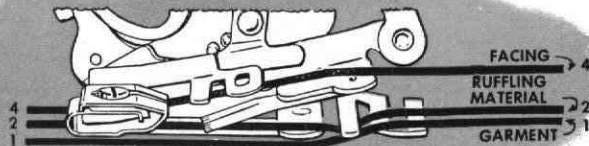
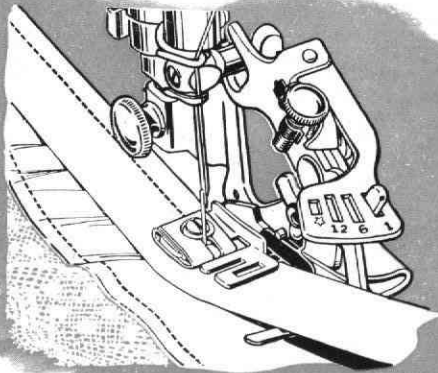

Fig. 66. Correct Positions for Materials



*To Make a Ruffle and Attach it with a Facing in One Operation*

1. Insert material to be ruffled between two blue blades and under separator guide (**Line 2, Fig. 66**).
2. Place material to which ruffle is to be attached under separator blade and under separator guide (**Line 1, Fig. 66**).
3. Place facing material over upper blue blade (**Line 4, Fig. 66**).
4. If facing is to be on **right side** of garment, place wrong sides of garment and ruffle together.
5. If facing is to be on **wrong side**, place right sides of garment and ruffle together.

Fig. 67. Making a Ruffle and Attaching it with a Facing in One Operation

### To Pipe a Ruffle

1. Insert material to be ruffled between two blue blades from the right (**Line 3, Fig. 68**). This material must not exceed 1-1/4 inches in width.

2. The piping material is usually cut on the bias and it should be about 1/4 inch wide when folded in center. Place piping material in ruffler, following (**Line 5, Fig. 68**) with folded edge of piping to right.

3. Fold edge of material to which piping and ruffling are to be attached and insert it in ruffler, from the left following (**Line 6, Fig. 68**).

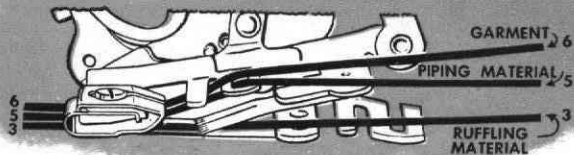

Fig. 68. Correct Positions for Materials

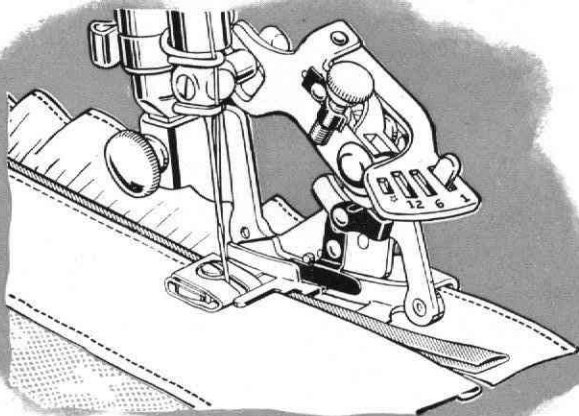

Fig. 69. Piping a Ruffle

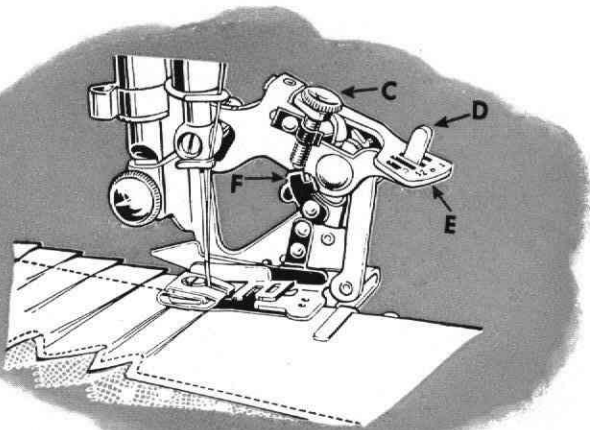
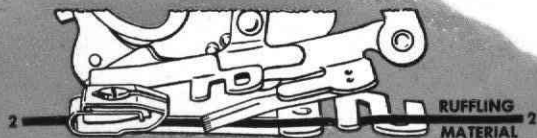

Fig. 70. Plaiting with Ruffler



### *To Adjust Ruffler for Plaiting*

1. Raise adjusting lever **E** and move it until projection **D** can be entered in slot marked "6." The ruffler will then plait once every six stitches. To plait once every 12 stitches, have projection **D** enter slot "12" in adjusting lever **E**.

2. Insert material to be plaited between two blue blades and under the separator guide (**Line 2, Fig. 71**).

3. To increase width of plait, move adjusting finger **F** back toward needle and turn adjusting screw **C** downward. To make a smaller plait, turn adjusting screw **C** upward. The distance between plaits is regulated by length of stitch.

Fig. 71. Correct Position for Material

### *To Adjust Ruffler for Group Plaiting*

1. To make the space between the groups of plaits, raise adjusting lever **E** and move it until projection **D** can be entered in small slot indicated by star on adjusting lever **E**. The ruffler will then stop plaiting and plain stitching will be made.

2. When desired space is made, set projection **D** in either of slots 6 or 12.

3. Insert material to be plaited between two blue blades and under the separator guide (**Line 2, Fig. 73**).

### **TO OIL THE RUFFLER**

Occasionally apply a drop of oil to working parts of ruffler at places indicated in **Fig. 72**.

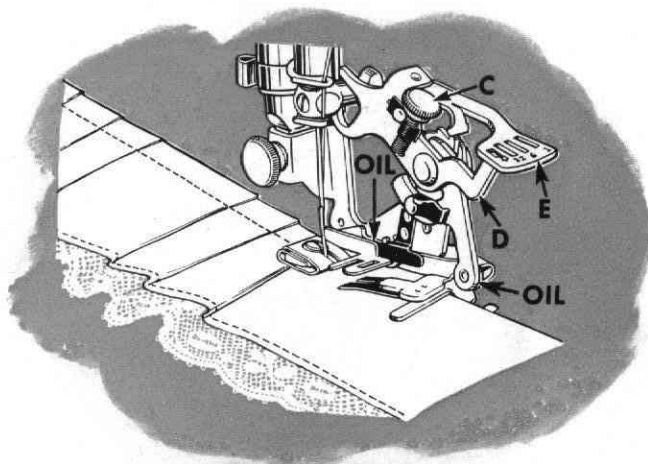

*Fig. 72. Group Plaiting with Ruffler*

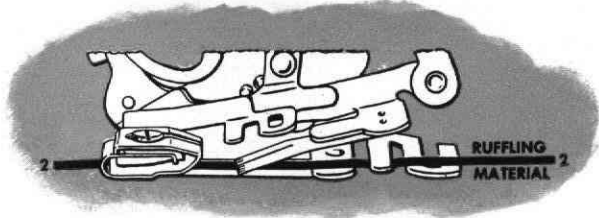

*Fig. 73. Correct Position for Material*

**DARNING OR EMBROIDERING**

Raise bed extension. Using a screwdriver, turn thumb screw **JJ** over from you as far as it will go. The feed is thus rendered inoperative and will not interfere with the free movement of the work.

Move stitch regulating lever **Y**, **Fig. 18** to its neutral position in center of slot at front of machine.

Remove presser foot and let down presser bar lifter **T**, **Fig. 17** to restore tension on needle thread which is released when lifter is raised.

Draw up bobbin thread as instructed on **page 16**.

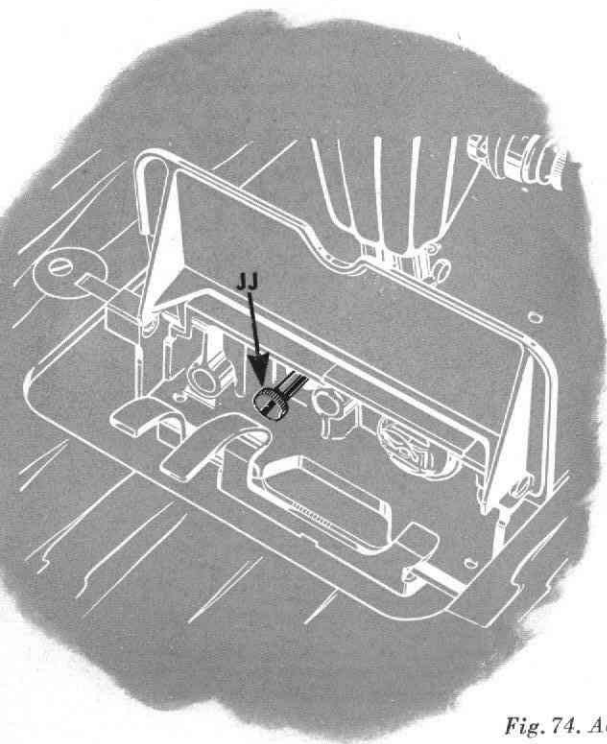

*Fig. 74. Adjustment for Darning or Embroidering*

When darning flat work, it is advisable to use embroidery hoops to hold the work.

Place work with unworn part near hole under needle. Commence darning by making a line of stitches across hole a little longer than width of hole. Continue making parallel lines of stitches across hole, moving work backward and forward and at the same time gradually moving work sidewise until hole is covered with lines of stitches running across hole. Then commence as before and move work lengthwise of hole until stitches across hole are completely covered and darn is finished.

When darning or embroidering is completed, turn thumb screw **JJ**, **Fig. 74** over toward you as far as it will go, using a screwdriver. Raise presser bar lifter **T**, **Fig. 17**, replace presser foot and reset stitch regulating lever **Y**, **Fig. 18** for desired length of stitch.

*Fig. 76. Darning Finished*

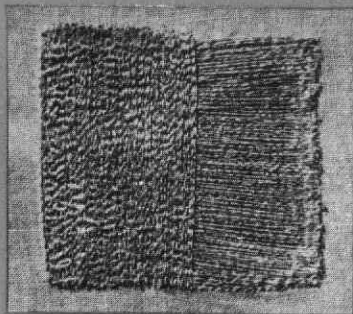

*Fig. 75. Darning in Process*

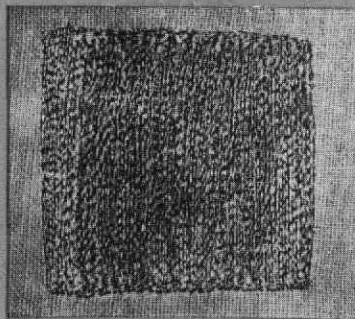

**THE IMPORTANCE OF USING  
SINGER® NEEDLES  
FOR YOUR SEWING MACHINE**

You will obtain the best stitching results from your sewing machine if it is fitted with a SINGER Needle.

SINGER Needles can be purchased from any SINGER Shop or SINGER Salesman.

SINGER Needles are contained in the SINGER Green Needle Packet with the famous red letter "S" upon it.

**THE IMPORTANCE OF USING  
SINGER® LUBRICANTS  
FOR YOUR SEWING MACHINE**

*"The Best is the Cheapest"*

**Use SINGER OIL on Machine**

Knowing from many years' experience the great importance of using good oil, SINGER sells an extra quality machine oil, especially prepared for sewing machines.

**Use SINGER MOTOR LUBRICANT  
on Motor and Gears of Machine**

The SINGER MOTOR LUBRICANT is especially prepared for lubricating the bearings of the electric motor and gears of the sewing machine. This is a pure non-flowing compound which retains its consistency and possesses high lubricating qualities.



## CONTENTS

	Page		Page
<b>Attachments</b>			
Foot Hemmer.....	34	<b>Portable Machine</b> .....	6
Adjustable Hemmer.....	39	Handle for Carrying Machine.....	7
Binder.....	41	<b>Presser Foot, to Regulate Pressure on Material.</b>	20
Edge Stitcher.....	48	<b>Service</b> .....	3
Gathering Foot.....	52	<b>Sewing</b>	
Ruffler.....	53	To Prepare for Sewing.....	16
<b>Bobbin</b>		To Commence Sewing.....	17
Removing.....	12	To Turn a Corner.....	18
Winding.....	12	Basting.....	18
Replacing.....	15	To Sew Bias Seams.....	18
<b>Darning or Embroidering</b> .....	60	To Remove the Work.....	18
<b>Electrical Information</b> .....	5	To Regulate Length of Stitch.....	19
Electrical Connections.....	6	To Regulate Direction of Feed.....	19
Singerlight.....	8	Sewing Suggestions.....	29
Features of 301 Machine.....	4	<b>Threading</b>	
<b>Lubrication</b>		Upper Threading.....	11
To Oil the Machine.....	26	Bobbin Case Threading.....	14
To Lubricate the Motor.....	28	<b>Thread Tensions</b> .....	20
Names of Principal Parts of 301 Machine.....	32	To Regulate Needle Thread Tension.....	21
<b>Needles and Threads to Use</b> .....	64	To Regulate Bobbin Thread Tension.....	21
<b>Needle Setting</b> .....	9	To Remove and Disassemble Needle Thread Tension...	22
		To Reassemble and Replace Needle Thread Tension...	22

**CHART SHOWING RELATIONSHIP OF TYPES OF FABRICS, THREAD AND  
NEEDLE SIZES AND MACHINE STITCHES TO THE INCH**

TYPES OF FABRICS	THREAD SIZES	NEEDLE SIZES	MACHINE STITCHES PER INCH	
			INSIDE SEAMS	TOP STITCHING
Filmy materials comparable to Net, Marquissette, Organdie, Ninon.	100 Cotton 00 and 000 Silk	9	20	30
Sheer materials comparable to Lawn, Dimity, Voile, Batiste, Chiffon, Rayon Sheer, Rayon Crepe.	80 to 100 Cotton O Silk	11	16	20
Lightweight materials comparable to Gingham, Chambray, Sheer Wool Crepe, Tafféta.	60 to 80 Cotton A and B Silk	14	12	18
Medium lightweight materials comparable to Pique, Poplin, Percale, Cretonne, Chintz, Faille, Bengaline, Wool Flannel, Wool Jersey, Wool Crepe.	50 to 70 Cotton B Silk	14	12	16
Medium heavy materials comparable to Corduroy, Crash, Gabardine, Velveteen, Rep.	40 to 50 Cotton C Silk	16	10	12
Heavy materials comparable to Sailcloth, Denim, Ticking.	30 to 40 Cotton D Silk	18	8	10
Plastic materials	Mercerized Cotton	11	10	12

*When ordering needles, always specify "Class and Variety 15x1" and state the size and quantity required.*

**TO ALL WHOM IT MAY CONCERN:**

The improper placing or renewal of the Trade Mark "SINGER" or any other of the Trade Marks of The Singer Manufacturing Company (all of which are duly Registered Trade Marks) on any machine that has been repaired, rebuilt, reconditioned, or altered in any way whatsoever outside a SINGER factory or an authorized SINGER agency is forbidden.

**FOR YOUR PROTECTION**

SINGER sells its machines only through SINGER SEWING CENTERS, identified by the Red "S" on the window, and never through department stores or other outlets.

When your machine needs servicing, call your SINGER SEWING CENTER and be sure of warranted SINGER parts and service.

See address in classified telephone directory listed only under

**SINGER SEWING MACHINE COMPANY**

