



BERNINA 330 | 350 PE | 380

made to create **BERNINA**

# LOOKING FOR A NEW SEWING PROJECT?

You can find what you want in "inspiration", our sewing magazine. Thanks to great sewing patterns and detailed sewing instructions, every project succeeds right away.

Inspiration magazine  
is available in German, English,  
French and Dutch



\* Not available in all countries.

Dear Bernina Customer,

Congratulations!

You've decided on BERNINA, a reliable choice that will delight you for years to come. For over 100 years, our family has placed the highest value on satisfied customers. For myself, it is a matter of personal pride to offer you Swiss precision at the height of perfection, future-oriented sewing technology, and a comprehensive customer service.

The BERNINA 330, 350 and 380 are primarily aimed at the occasional sewer who puts great stock in design and customer benefit. These sewing computers are very ergonomically built and therefore even easier to operate, to help you, our esteemed customers, on your journey to even greater sewing pleasure and perfect results.

Enjoy creative sewing with BERNINA:

Find out about our varied range of accessory and let yourself be inspired by new sewing projects at [www.bernina.com](http://www.bernina.com).

And don't forget to make use of service and maintenance offers from our highly trained BERNINA dealers.



H.P. Ueltschi  
Owner  
BERNINA International AG  
CH-8266 Steckborn  
[www.bernina.com](http://www.bernina.com)



# SAFETY INSTRUCTIONS

## IMPORTANT SAFETY INSTRUCTIONS

When using an electrical appliance, basic safety precautions should always be followed, including the following:

Read all instructions before using this sewing computer.

**When the sewing computer is not in use, it should be disconnected from the electricity supply by removing the plug from the outlet.**

### **DANGER!**

To reduce the risk of electrical shock:

1. The sewing computer should never be left unattended when plugged in.
2. Always unplug the sewing computer from the electrical outlet immediately after using and before cleaning.
3. LED radiation. Do not view directly with optical instruments. LED class 1M

### **WARNING!**

To reduce the risk of burns, fire, electric shock or injury to persons:

1. Use the sewing computer only for purposes as described in this manual. Use only attachments/accessory recommended by the manufacturer as contained in this manual.
2. Do not allow the sewing computer to be used as a toy. Close attention is necessary when this sewing computer is used by or near children and infirm persons. This sewing computer is not intended for use by persons (including children) with reduced physical, sensory or mental capabilities, or lack of experience and knowledge, unless they have been given supervision or instruction concerning use of the sewing computer by a person responsible for their safety. Children must be kept under supervision to ensure that they do not play with the sewing computer.

3. Never operate this sewing computer if:
  - it has a damaged cord or plug
  - it is not working properly
  - it has been dropped or damaged
  - it has fallen into waterTake the sewing computer to the nearest authorized BERNINA dealer for examination, repair, electrical or mechanical adjustment.
4. Never operate the sewing computer with any air vents blocked. Keep ventilation openings of the sewing computer free from lint, dust and/or fabric bits.
5. Keep fingers away from all moving parts. Special care is required in the needle area of the sewing computer.
6. Never drop or insert any objects into any opening on the sewing computer.
7. Do not use the sewing computer outdoors.
8. Do not operate the sewing computer where aerosol products (spray) or oxygen is being administered.
9. Do not pull or push the fabric while stitching. This may deflect the needle, causing it to break.
10. Do not use bent needles.
11. Always use the BERNINA original stitch plate. The wrong stitch plate can cause needle breakage.
12. To disconnect, turn power switch to «0» (off), then remove the plug from the outlet. Do not unplug by pulling the cord, instead grasp the plug to pull it from the outlet.
13. Turn power switch to «0» (off) when making any adjustments in the needle area, such as changing the needle or the presser foot, etc.
14. Always unplug the sewing computer from the electrical outlet when carrying out cleaning or maintenance work or any other user servicing adjustments mentioned in this manual.
15. This sewing computer is provided with double insulation (except USA and Canada). Use only genuine replacement parts. Please note the advice on the servicing of double-insulated products.

## SERVICING DOUBLE INSULATED PRODUCTS

In a double-insulated product, two systems of insulation are provided instead of grounding. No grounding means is provided on a double-insulated product nor should a means for grounded be added to the product. Servicing a double-insulated product requires extreme care and knowledge of the system and should only be done by qualified service personnel. Replacement parts for a double-insulated product must be identical to the original parts in the product. A double insulated product is marked with the words: «Double-Insulation» or «double-insulated».

The symbol  may also be marked on the product.

## DISCLAIMER

No liability will be assumed for any possible damage which arises from misuse of this sewing computer.

This sewing computer is intended for household use only.

## SAVE THESE INSTRUCTIONS!



Please find the latest version of your instruction manual at [www.bernina.com](http://www.bernina.com)



### Environmental Protection

BERNINA is committed to the protection of the environment. We strive to minimize the environmental impact of our products by continuously improving product design and our technology of manufacturing.

At end of life please dispose this product in an environmentally responsible way according to the national directive. Do not throw away this product with your household waste. In case of doubt, please contact your dealer.



If the sewing computer is stored in a cold room, it should be brought to a warm room about one hour before use.

<b>Accessory</b>		<b>5-7</b>
<b>Preparation</b>		<b>8-23</b>
<ul style="list-style-type: none"> <li>■ Details of the sewing computer 8</li> <li>■ Preparation for sewing 10</li> </ul>		
<b>Functions</b>		<b>24-29</b>
<ul style="list-style-type: none"> <li>■ Function buttons on the sewing computer 24</li> <li>■ Details of the screen 26</li> <li>■ Memory 27</li> </ul>		
<b>Sewing stitches</b>		<b>30-43</b>
<ul style="list-style-type: none"> <li>■ Practical stitches 30</li> <li>■ Examples of application 31</li> <li>■ Buttonholes 36</li> <li>■ Practical-/Quiltstitch 43</li> </ul>		
<b>Cleaning, maintenance</b>		<b>44</b>
<ul style="list-style-type: none"> <li>■ Sewing computer and screen 44</li> <li>■ Lubricating 44</li> </ul>		
<b>Troubleshooting</b>		<b>45</b>
<b>Stitch patterns</b>		<b>46</b>
<b>Index</b>		<b>47-49</b>

## Glossary

<b>Balance</b>	Correcting abnormalities in stitch formation due to the fabric
<b>clr</b>	Deleting settings or data
<b>LED</b>	Sewing light system
<b>FHS</b>	Free-Hand System = Knee-operated presser-foot lifter
<b>mem</b>	Memory = Longterm data store
<b>Bartack</b>	Buttonhole-bead cross-connections
<b>Satin stitching</b>	Dense zig-zag
<b>Fabric fold</b>	Folded edge of material
<b>Hook</b>	«Catches» the needle-thread loop, forming the seam together with the lower thread



**Very important!  
Risk of damage!**



Supplementary information!

\* **Not** supplied as standard with the BERNINA 330  
 \*\* **Not** supplied as standard with the BERNINA 350  
 \*\*\* **Not** supplied as standard with the BERNINA 380

## Standard Accessory



- Fabric cover
- Accessory box \*\*
- Accessory case \*\*\*
- Foot control
- Power cable
- Slide-on table\*
- Stitch pattern summary card
- Free-Hand System FHS \*\*

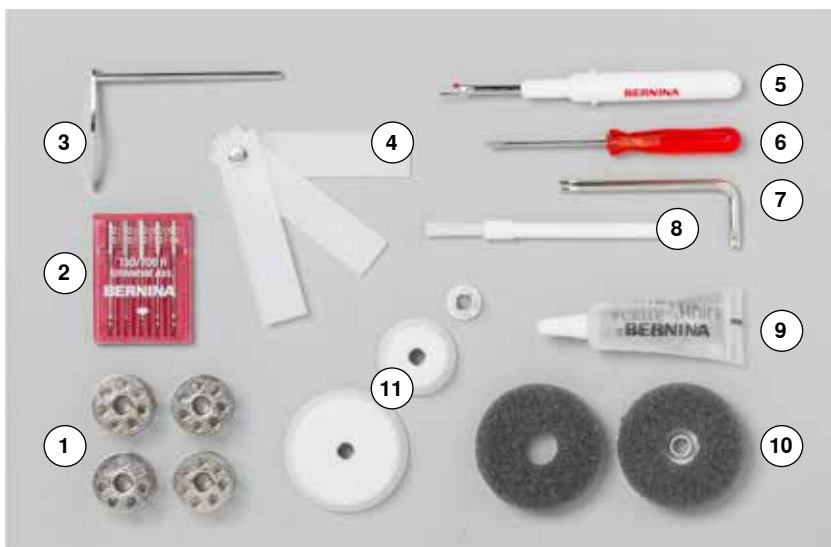

- 1 5 bobbins (one of them in the bobbin case)
- 2 Selection of needles
- 3 Seam guide, right
- 4 Height compensating tool
- 5 Seam ripper
- 6 Screwdriver, red
- 7 Angular Torx button
- 8 Lint brush
- 9 Lubricator
- 10 2 foam pads
- 11 3 spool discs

**Presser Feet/Snap-On Soles (BERNINA 330/350/350 PE/380)**

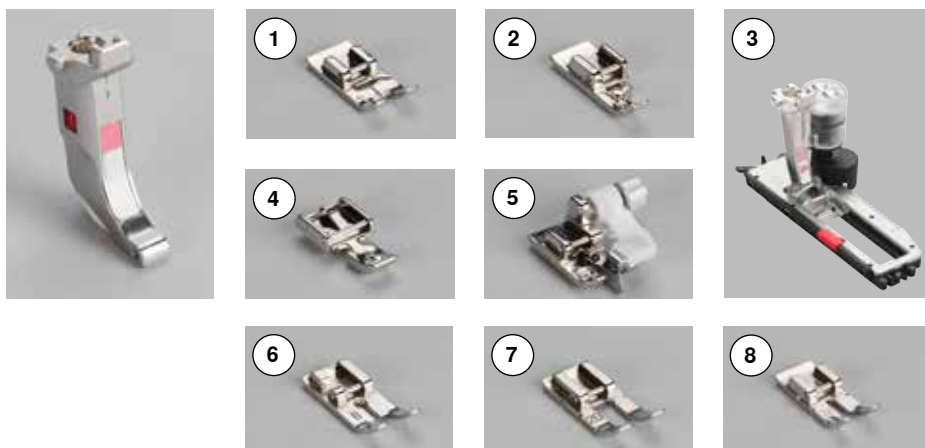

- 1 No. 1 Reverse pattern sole
- 2 No. 2 Overlock sole (without 350 PE)
- 3 No. 3A Automatic Buttonhole foot with slide
- 4 No. 4 Zipper sole
- 5 No. 5 Blindstitch sole
- 6 No. 8 Jeans sole \*/\*\*/(without 350 PE)
- 7 No. 20 Open embroidery sole \*
- 8 No. 37 Patchwork sole (only 350 PE)

**Presser Feet - Standard (BERNINA 350/350 PE/380)**

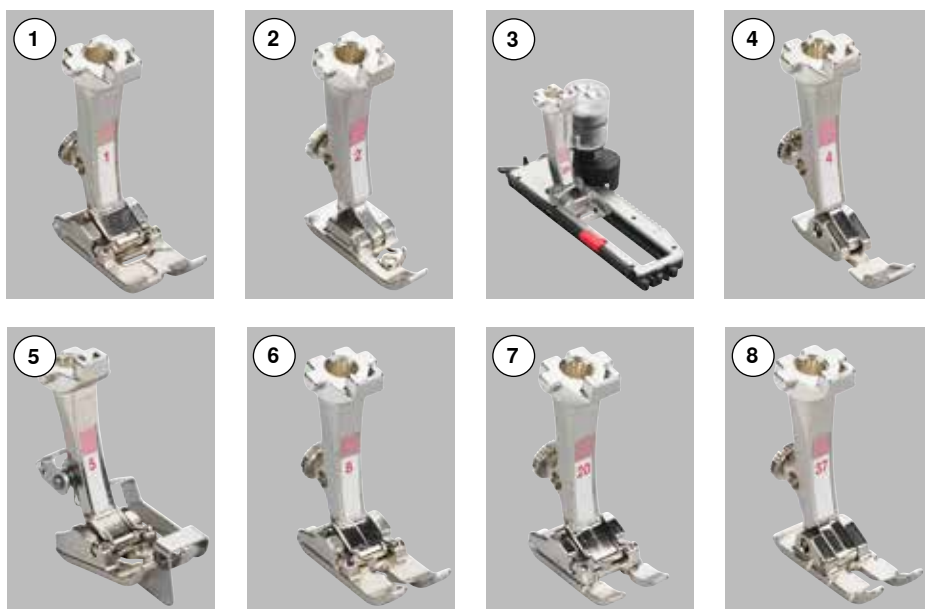

- 1 No. 1 Reverse pattern foot
- 2 No. 2 Overlock foot (without 350 PE)
- 3 No. 3A Automatic Buttonhole foot with slide
- 4 No. 4 Zipper foot
- 5 No. 5 Blindstitch foot
- 6 No. 8 Jeans foot \*\*/(without 350 PE)
- 7 No. 20 Open embroidery foot
- 8 No. 37 Patchwork foot (only 350 PE)

 More accessories you can found on [www.bernina.com](http://www.bernina.com)

Presser Feet: can vary from country to country (Snap-On Soles or Standard).



### Accessory Box \*/\*\*



#### Storing Accessory

Standard accessory are supplied in a plastic bag. They can be stored as shown in the picture.



### Accessory Case \*\*\*



Standard accessory for the models B330/350 can be carefully stored in the case. Buttonhole foot 3A is stored inside in a separate compartment.

**8 Preparation - Details of the sewing computer**

**Front View**



**Detail View**

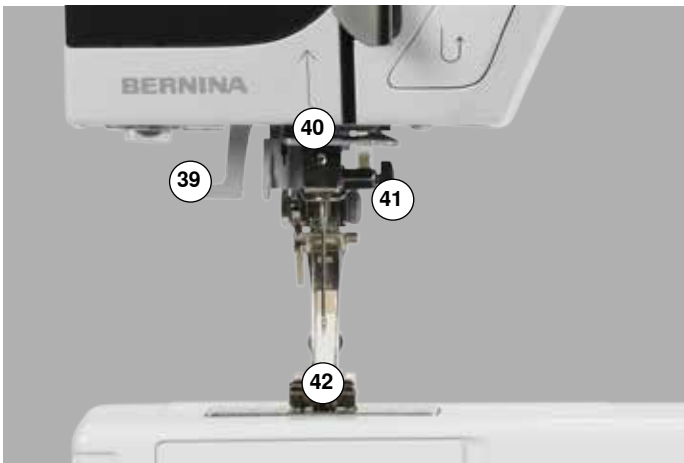



- |   |  |
|---|--|
| 1 Bobbin cover                          | 26 FHS (Free Hand System) connection * |
| 2 Stitch plate                          | 27 Thread tension adjustment wheel     |
| 3 Attachment base for special accessory | 28 Rear thread guide                   |
| 4 LED sewing light                      | 29 Carrying handle                     |
| 5 Quick reverse button                  | 30 Vertical spool pin                  |
| 6 Start/Stop button                     | 31 Horizontal spool pin                |
| 7 Thread take-up cover                  | 32 Eyelet                              |
| 8 Thread take-up lever                  | 33 Handwheel                           |
| 9 Bobbin winder pre-tension             | 34 Balance adjuster                    |
| 10 Speed control                        | 35 Foot control socket                 |
| 11 Screen                               | 36 Feed-dog drop                       |
| 12 Needle stop up/down button           | 37 Power switch on/off                 |
| 13 Pattern end button                   | 38 Power plug socket                   |
| 14 Mirror image button */**             | 39 Needle threader                     |
| 15 Stitch length buttons                | 40 Thread guide                        |
| 16 Needle position buttons              | 41 Needle clamp                        |
| 17 Stitch width buttons                 | 42 Presser Foot                        |
| 18 Bobbin winder device                 | 43 Thread cutter in hook opening       |
| 19 Thread cutter on bobbin winder       | 44 Feed dog                            |
| 20 Memory buttons                       | 45 Thread cutter on head frame (left)  |
| 21 Alphabet button                      | 46 Presser foot lifter                 |
| 22 Stitch selection buttons             | 47 Darning hoop connection             |
| 23 #-button (hash button)               |  |
| 24 «clr» (clear) button                 |  |
| 25 Slide-on table socket                |  |



**(USA/Canada only):**

The sewing computer has a polarized plug (one blade wider than the other). To reduce the risk of electrical shock, this plug is intended to fit in a polarized outlet only one way. If the plug does not fit fully in the outlet, reverse the plug. If it still does not fit, contact a qualified electrician to install the proper outlet. Do not modify the plug in any way!

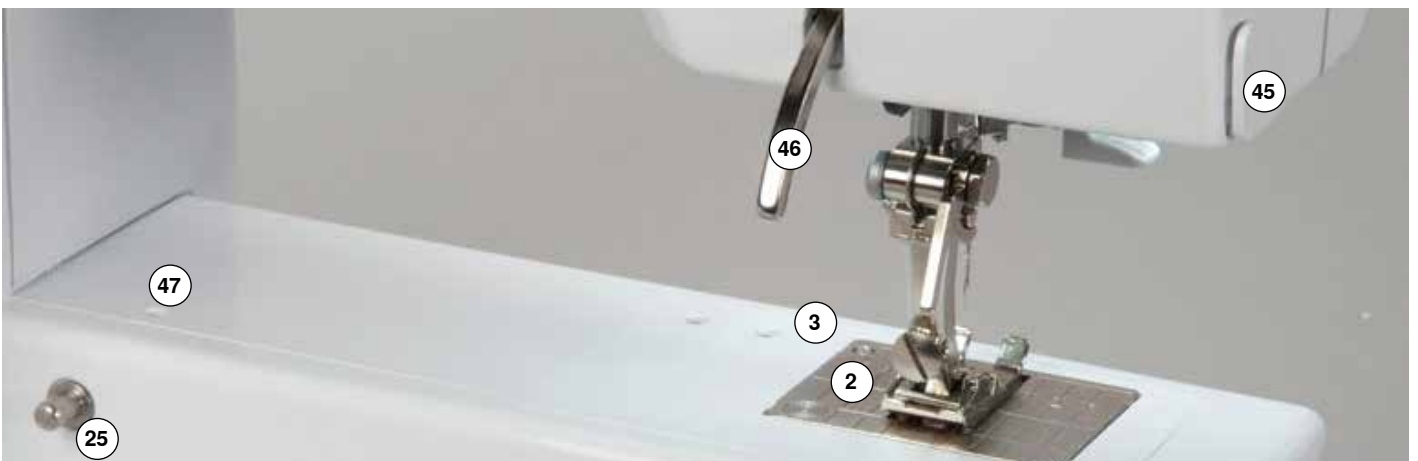

## Foot Control

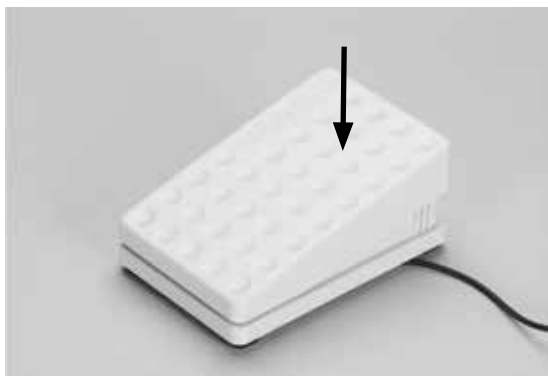

### Sewing speed control

- control the sewing speed by pressing the foot control



### Self storing cord

- wind the cable around the spool
- insert the plug into the groove provided

### While sewing

- unwind the cable

## LED Sewing Light



The LED sewing light illuminates the sewing area and has a long product life.



**Please note that a defective sewing light must ONLY be replaced by an authorized technician.**

**The sewing computer must be taken to an authorized BERNINA dealer!**

## Slide-on Table \*



The slide-on table increases the sewing surface.

### Attaching the slide-on table

- raise needle and presser foot
- slide over free-arm to the right until it engages

### Removing the slide-on table

- raise needle and presser foot
- press button down and pull off slide-on table to the left

## Presser Foot Lifter (FHS) \*/\*\*



The FHS raises and lowers the presser foot.

### Attaching the lifter

- insert into the opening; you should be able to operate the FHS with your knee in your normal sitting position

### Raising and lowering the presser foot

- with your knee push lever to the right
- the presser foot is raised; the feed dog is lowered simultaneously. The thread tension is released
- the feed dog is raised as soon as the first stitch is sewn



Your dealer can adjust the FHS if necessary.

## Vertical Spool Pin

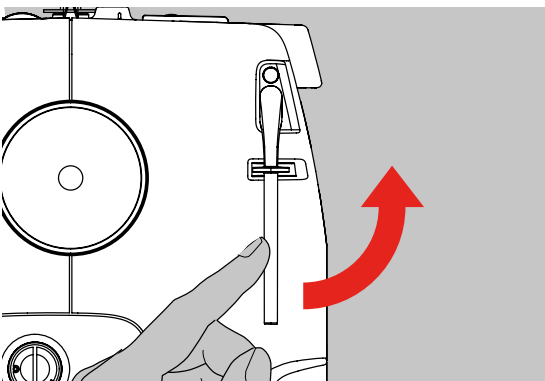

- the vertical spool pin is on the side behind the handwheel
- it is an essential aid for sewing with more than one thread, i.e. double needle work
- raise the pin until it clicks into its vertical position
- when using large reels, add the foam pad **A** for stability

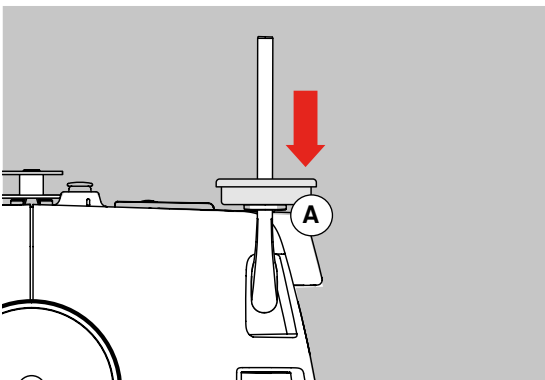

## Winding a Bobbin

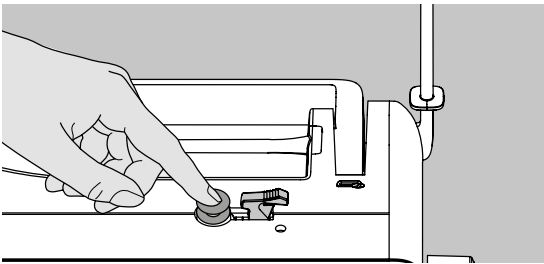

- turn power switch on (to «I»)
- place empty bobbin on spindle
- place thread on spool pin
- attach appropriate spool disc; diameter of thread spool determines disc size
- following the direction of the arrow take thread through the rear guide and round the pre-tension stud
- wind the thread two to three times around the empty bobbin and cut off any excess thread on the thread cutter
- push engaging lever against bobbin, the winder works automatically
- the motor will stop automatically when the bobbin is full

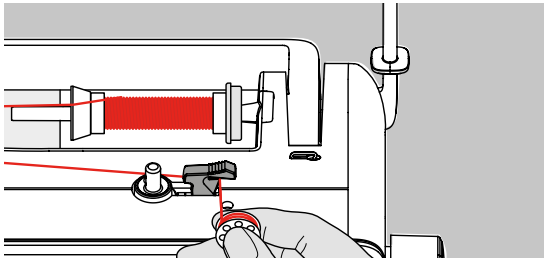
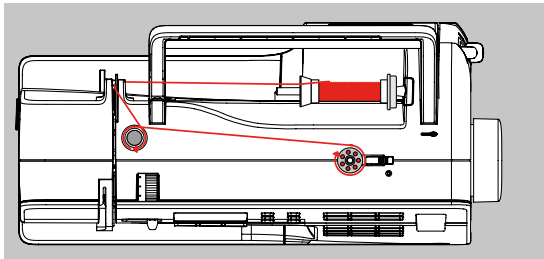

### Thread cutter

- pull thread over thread cutter when removing the bobbin

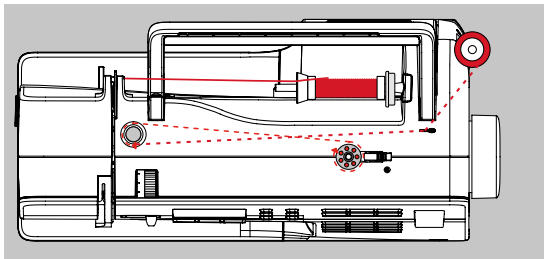

### Bobbin winding while sewing

- place thread spool on vertical spool pin then, following the direction of the arrow, take thread through the thread guide and around the pre-tension stud
- then proceed as mentioned above

## Inserting a Bobbin

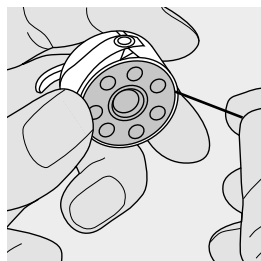
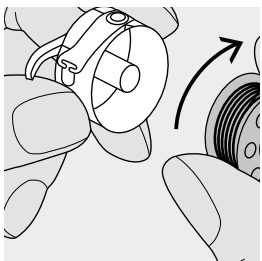

Insert the bobbin so that the thread runs clockwise.

### Laying the thread into the slot

Pull the thread counter clockwise into the slot.

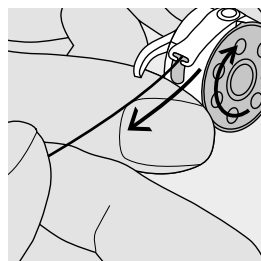
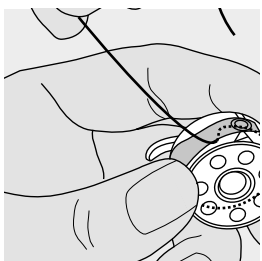

### Pulling the thread under the spring

Pull the thread to the left under the spring until it lies in the T-shaped slit at the end of the spring. The bobbin must turn clockwise.

## Bobbin Case

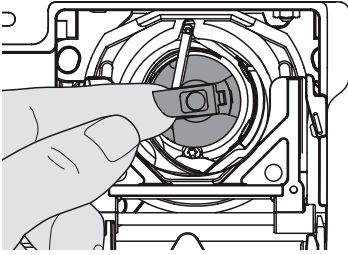

### To remove the bobbin case

- raise needle
- power switch to «0» (off)
- open the bobbin cover
- grasp the latch of the bobbin case
- remove bobbin case

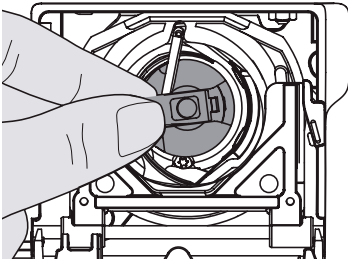

### To insert the bobbin case

- hold the bobbin case latch
- the finger on the case should point upwards
- insert the case so that it clicks into place



The bobbin thread does not have to be brought up as the loose end is just the right length to start sewing.

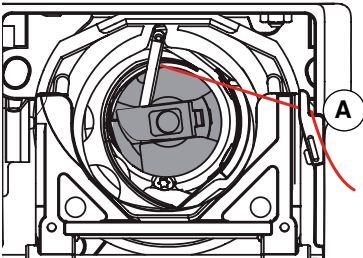

### Bobbin thread cutter

- insert the bobbin case
- take the thread over cutter **A** and cut it
- close the bobbin cover

## Needle Threader

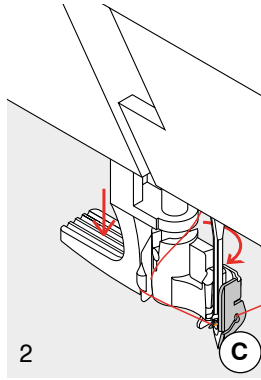
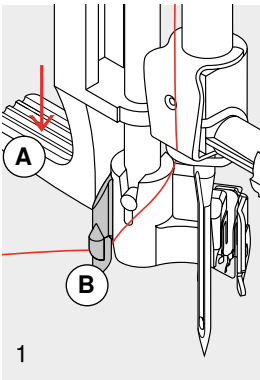

### 1 Press lever down

- raise needle
- lower the presser foot
- hold thread to the left and back
- press lever A down and simultaneously guide the thread around hook B to the right to the needle

### 2 Guide thread to front of the needle

- put the thread from the front into the guide C until it catches in the wire hook

### 3 Release lever and thread

- release lever A and thread
- put the thread under the foot and pull the thread backwards or
- put the thread under the foot and pull it from front to back over the thread cutter on left side of the head frame

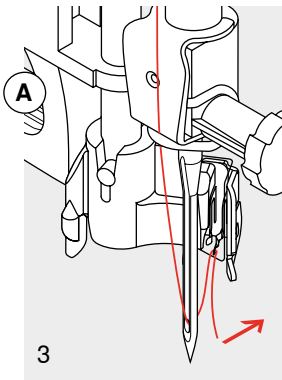

## Threading the Upper Thread

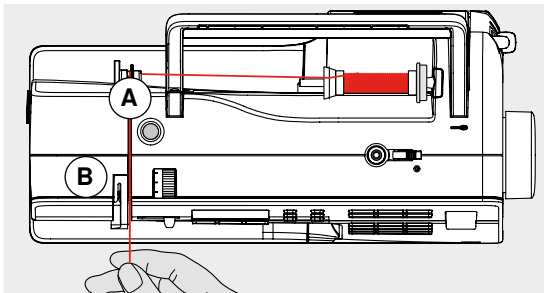

### Attaching the thread spool

- raise the needle and presser foot
- power switch to «0» (off)
- place foam pad on pin base
- place spool on pin (thread unwinds clockwise)
- attach appropriate spool disc - diameter of spool determines disc size, there must be no clearance between the disc and the spool
- take thread through rear guide A
- then into slit of upper thread tension B
- pull thread down to the right of the take-up cover and around C
- take thread up to the left of the cover and around D, placing it in the take-up lever
- take thread down and through guides E and F

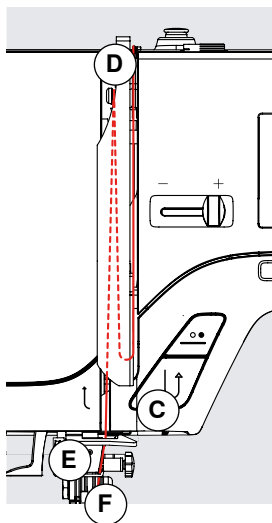
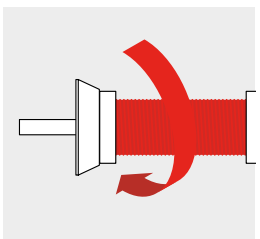
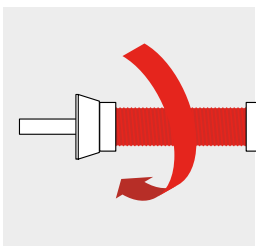



## Threading the Double Needle

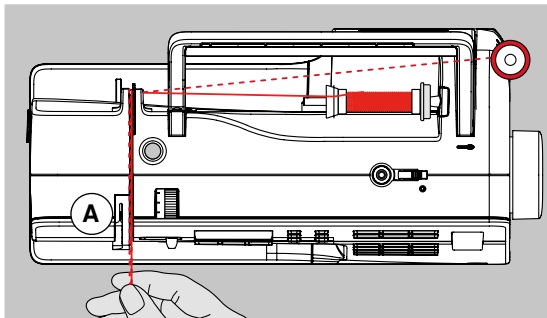

### Threading the First Thread

- place thread spool on horizontal spool pin and thread
- guide the thread to the front in the slit and past the tension disc **A** on the right side
- thread sewing computer as usual and thread the right needle

### Threading the Second Thread

- place thread spool on the vertical spool pin and thread
- guide the thread to the front in the slit and past the tension disc **A** on the left side
- thread the left needle
- threads must not be twisted together

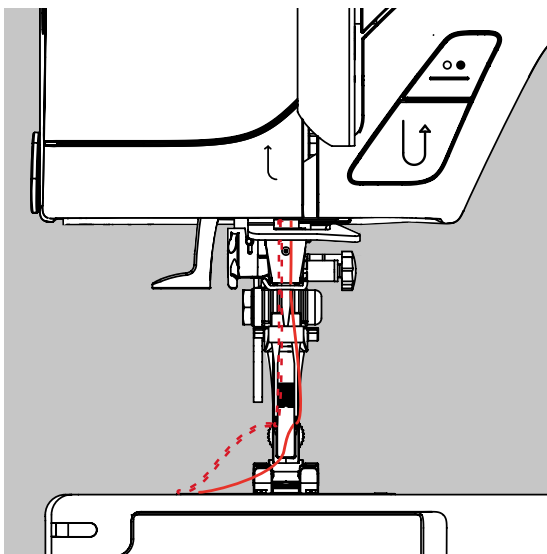

## Threading the Triple Needle

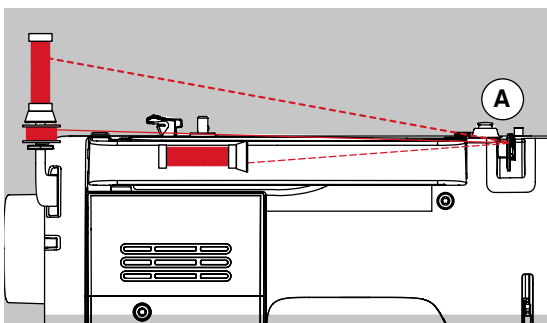

- two thread spools and one full bobbin are needed
- place one thread spool on horizontal spool pin
- place second thread spool and the bobbin, separated by a spool disc, on vertical spool pin (both spools have to turn in the same direction)
- thread as usual by guiding two threads on the left side of the tension disc **A** and one thread on the right side of the disc

## Thread Cutter

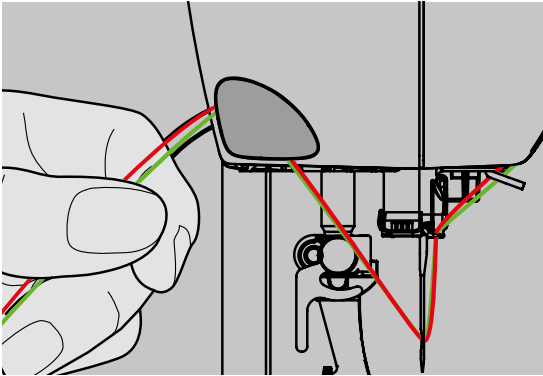

### On the left of the head frame

- pull both threads from front to back over the cutter
- the threads release automatically as soon as the first stitch is sewn

## Changing the Needle

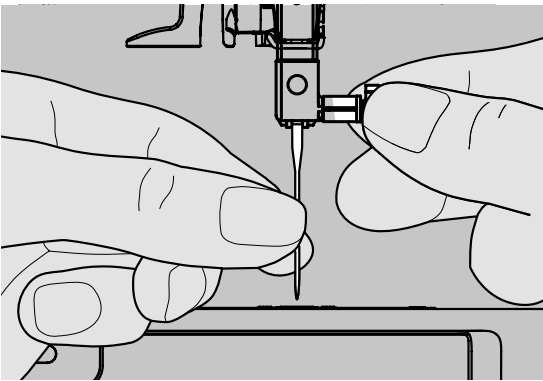

### Removing the needle

- raise needle
- power switch to «0» (off)
- lower the presser foot
- loosen the needle clamp screw
- pull the needle down to remove

### Inserting the needle

- flat side of needle to the back
- insert the needle as far as it will go
- tighten the needle clamp screw

## Changing the Presser-Foot Sole

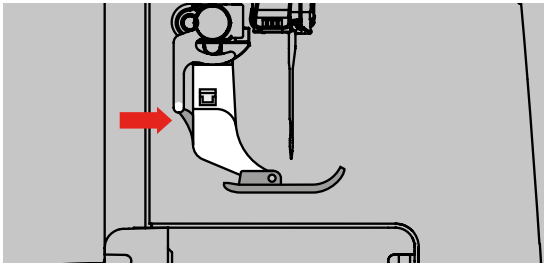

- raise the needle and the presser foot shaft
- power switch to «0» (off)
- press the button on the shaft to release the sole

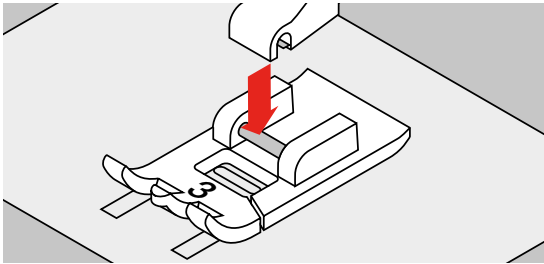

### Attaching the presser-foot sole

- place the presser-foot sole under the shaft so that the peg sits under the opening of the shaft

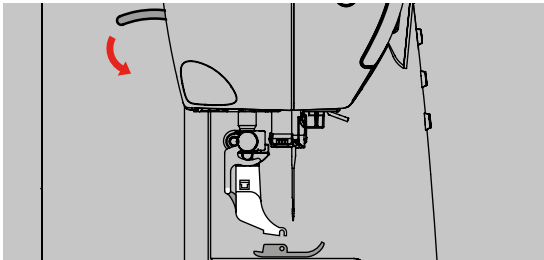

- lower the presser-foot lifter and the foot sole will click into position

## Changing the Presser Foot

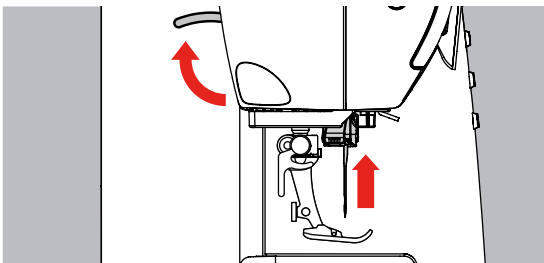

### Changing the Presser Foot

- raise the needle and presser foot
- power switch to «0» (off)

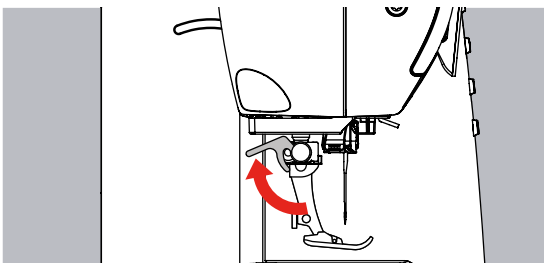

### Raising the Lever

- raise the clamping lever
- remove the presser foot

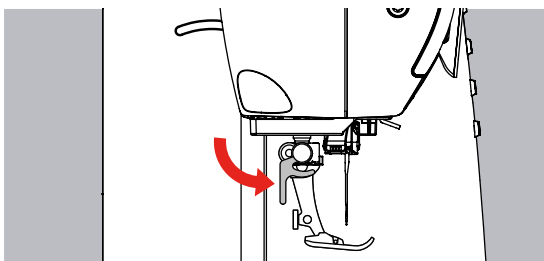

### Attaching the Presser Foot

- guide the foot upwards over the cone
- press the clamping lever down

## Stitch Plate

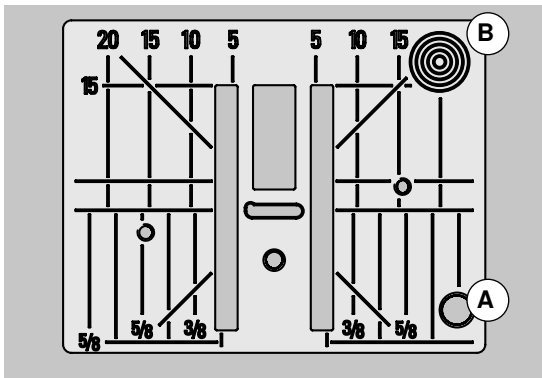

### Stitch Plate Markings

- the stitch plate is marked with vertical, horizontal and diagonal lines in mm and inches
- the lines help to guide the fabric for sewing seams and precise topstitching, etc.
- the horizontal markings are helpful for sewing corners and buttonholes, etc.
- the diagonal markings are useful for quilting
- the vertical measurements correspond to the distance between the needle and the line
- needle insertion point is position 0 (center needle position)
- the measurements are marked to the right and left, measuring from the center needle position

### Removing the Stitch Plate

- raise the presser foot and needle
- power switch to «0» (off)
- press the stitch plate down at the right back corner **B** until it flips up
- remove the stitch plate

### Replacing the Stitch Plate

- place the stitch plate over the opening **A** and press down until it clicks into place

## Thread Tension

**Optimal upper thread tension is set in the factory. For this, Metrosene threads 100/2 weight (Mettler, Switzerland) are used in the bobbin and also in the upper thread.**

The tension may vary when using other types of thread such as embroidery thread, and it may therefore be necessary to adjust the tension to suit the fabric and stitch type.

**For example:**

	Tension	Needle
<b>Metallic thread</b>	approx. 3	90
<b>Monofilament</b>	approx. 2-4	80

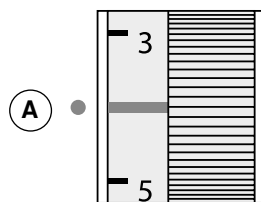

### The Basic Setting

- is indicated when the red line on the tension adjustment wheel is in line with the marking **A**
- the tension does not need adjusting for normal sewing work
- for special sewing work, the tension can be adjusted to suit the fabric



### Perfect Stitch Formation

- the interlooping of the threads is in the fabric



### Upper thread tension too tight

- the lower thread is pulled more up, i.e. to the right side of the fabric
- to reduce the upper thread tension turn tension adjustment wheel to 3-1



### Upper thread tension too loose

- the upper thread is pulled more down, i.e. to the wrong side of the fabric
- to increase the upper thread tension turn tension adjustment wheel to 5-10

## Balance

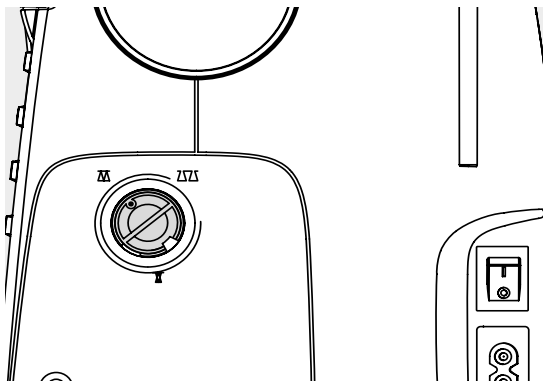

Different fabrics, threads and stabilizers can naturally affect the stitch balance so that the stitch patterns are sewn too close together or not close enough.

This can be remedied with Balance to suit the fabric and produce perfect results.



### Test-sewing

When using decorative stitches, we recommend to test-sew the stitch pattern on a piece of the project fabric.

If the balance has been adjusted, return it to the normal setting once sewing is completed!

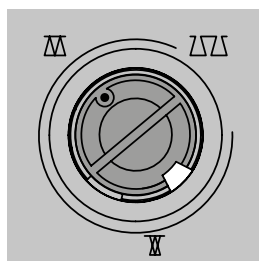

Normal position

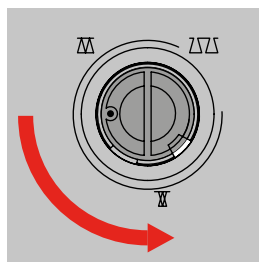

Denser stitch formation - pulling the stitch pattern closer together (shorter stitch length)

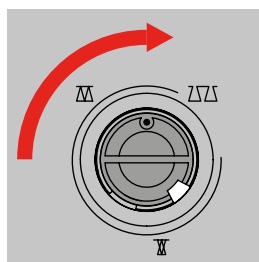

Finer stitch formation - extending the stitch pattern (longer stitch length)

## Feed Dog

### Feed-Dog Drop

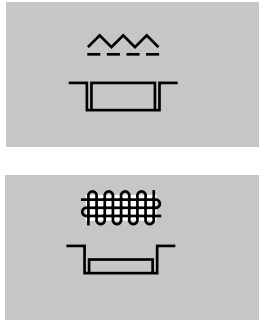
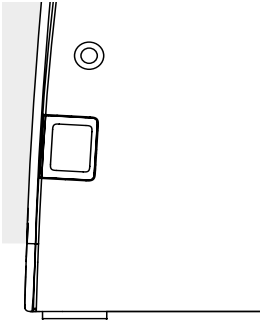

Button flush with housing = sewing position.  
Button depressed = feed-dog is lowered.

■ for free-motion sewing (darning, embroidery, quilting, etc.)

### Feed-dog and fabric feed

With each stitch the feed dog moves forward by one step. The length of this step is determined by the stitch length selected.

With an extremely short stitch length, the steps are also very short. The fabric moves under the foot quite slowly, even at full sewing speed. e.g. buttonholes, satin stitch and decorative stitches are all sewn with a very short stitch length.

Let the fabric feed evenly.

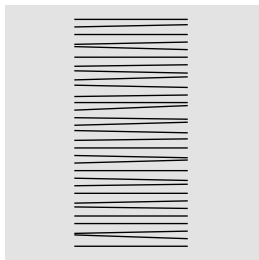
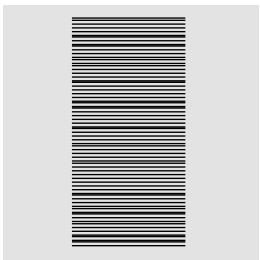
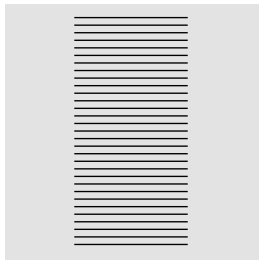

Pulling, pushing or holding back the fabric will result in uneven stitches.

## Height Compensation of Uneven Layers

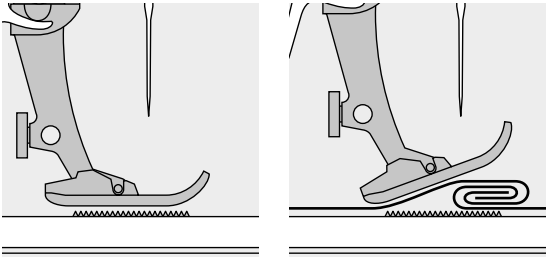

The feed dog works accurately when the foot is level.

If the foot is at an angle, e.g. when sewing over thick to thin or vice-versa, the feed dog cannot grip and feed the fabric. The fabric might jam.

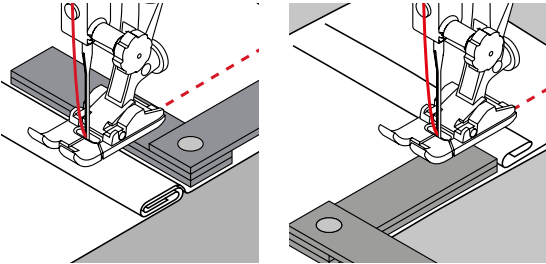

To solve this problem, place one, two or three compensating plates as required behind the needle under the presser foot to level it.

To correct the height in front of the foot, place one or more plates to the right of the foot close to the needle. Sew until the foot is level again and remove the plates.

## Sewing Corners

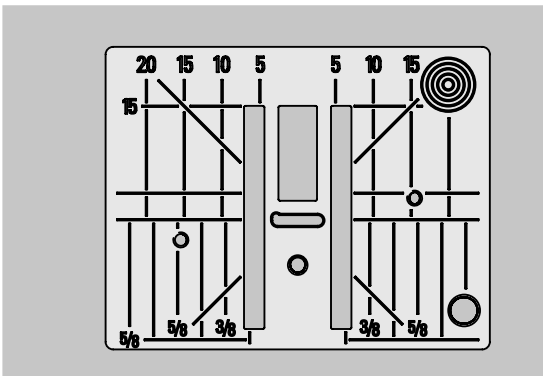

When sewing corners only a small section of the fabric is actually on the feed dog. Therefore it cannot grip the fabric well.

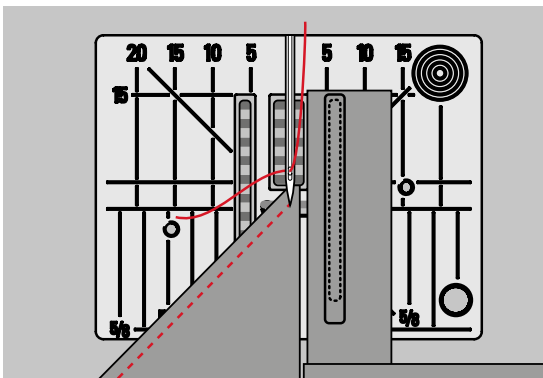

Correct this by placing one or more compensating plates as close as possible to the edge of the fabric.

## Important Facts about Sewing Needles

### Thread

The thread is chosen according to use. For a perfect sewing result, thread and fabric quality play an important role. It is recommended to use quality brands.

#### Cotton thread

- cotton thread has the advantage of being a natural fiber and therefore is especially suitable for sewing cotton fabrics
- if cotton thread is mercerized, it has a slight sheen

#### Polyester thread

- it has a high tensile strength and is particularly colorfast
- polyester thread is more flexible and is recommended where a strong and elastic seam is required

### Needle, Thread and Fabric

Care must be taken when choosing needle and thread.

The correct needle size depends on the selected thread and fabric. The fabric weight and type determine the thread weight, needle size and point form.



#### Checking the needle condition

**The needle condition should be checked and the needle replaced regularly. A defective needle not only damages the fabric but also the sewing computer.**

**Follow these guidelines:**

**Always replace the needle when starting a new sewing project.**

### Needles, Threads

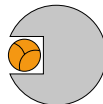

#### Correct needle/thread combination

When sewing, the thread should travel smoothly down the long groove on the front of the needle.



#### Too thin thread or too thick needle

The thread has too much clearance in the groove. Skipped stitches and damage to the thread can occur.

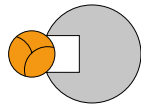

#### Too thick thread or too fine needle

The thread rubs on the edges of the groove and can get jammed. This can break the thread.









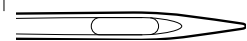

#### Fabric/Thread

#### Needle size

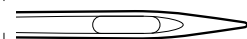
Fine fabrics: Fine thread (darning thread, embroidery thread)	70-75
Medium weight fabrics: Normal thread	80-90
Heavy weight fabrics:	100, 110, 120

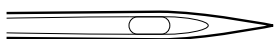

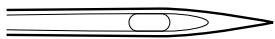
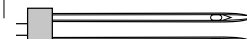
## Overview Needles

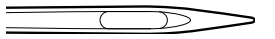
 <p><b>Universal</b> 130/705 H/60-100</p> <p>Normal point, slightly rounded</p> <p>For nearly all natural and synthetic fabrics (woven and knitted)</p>	 <p><b>Metafil</b> 130/705 H-MET/75-90</p> <p>Large eye</p> <p>Sewing with metallic threads</p>
 <p><b>Jersey/Stretch</b> 130/705 H-S, H-SES, H-SUK/70-90</p> <p>Ball point</p> <p>Jersey, knits, stretch fabrics</p>	 <p><b>Cordonnet (Topstitching)</b> 130/705 H-N/80-100</p> <p>Small ball point, long eye</p> <p>Topstitching with thick thread</p>
 <p><b>Leather</b> 130/705 H-LL, H-LR/90-100</p> <p>With cutting point</p> <p>Natural and synthetic leather and plastic films</p>	 <p><b>Wing needle (hemstitch needle)</b> 130/705 HO/100-120</p> <p>Wide needle (wing)</p> <p>Hemstitching</p>
 <p><b>Jeans</b> 130/705 H-J/80-110</p> <p>Very fine sharp point</p> <p>Heavy weight fabrics such as jeans, canvas, overalls</p>	 <p><b>Double wing needle</b> 130/705 H-ZWI-HO/100</p> <p>Special effects with hemstitch embroidery</p>
 <p><b>Microtex</b> 130/705 H-M/60-90</p> <p>Especially fine sharp point</p> <p>Micro fiber fabrics and silk</p>	 <p><b>Double needle</b> 130/705 H-ZWI/70-100</p> <p>Needle distance: 1.0/1.6/2.0/2.5/3.0/4.0</p> <p>Visible hems in stretch fabrics, pintucks, decorative sewing</p>
 <p><b>Quilting</b> 130/705 H-Q/75-90</p> <p>Fine sharp point</p> <p>Straight and topstitching</p>	 <p><b>Triple needle</b> 130/705 H-DRI/80</p> <p>Needle distance: 3.0</p> <p>For decorative sewing</p>
 <p><b>Embroidery</b> 130/705 H-SUK/75-90</p> <p>Large eye, slight ball point</p> <p>Embroidery on all natural and synthetic fabrics</p>	

## Function Buttons on the Sewing Computer



### Stitch Selection

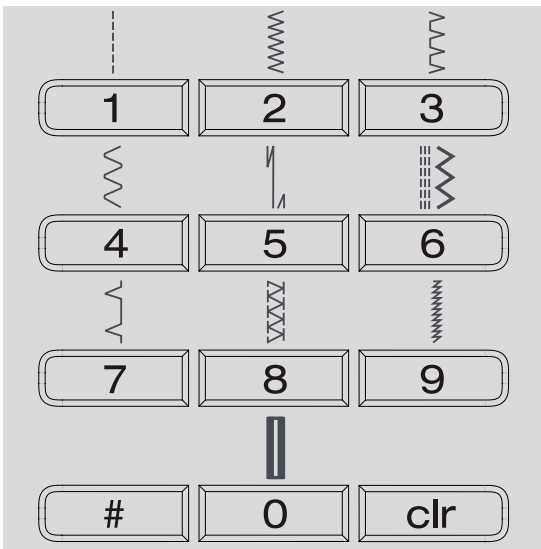

- for stitch patterns 1-10:  
press the number button of your choice; stitch number and default width and length settings appear
  - press «0» to select stitch number 10 (standard buttonhole)
- for stitch patterns 11-99:  
press #-button and enter desired stitch number
- for stitch patterns 100 and beyond:  
press #-button twice and enter desired stitch number

### Customizing Stitch Settings

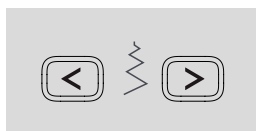

#### Altering stitch width

- left button = narrow the stitch width
- right button = widen the stitch width
- the basic settings of the chosen stitch blink constantly

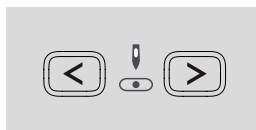

#### Altering needle position

- left button = needle to the left
- right button = needle to the right



#### Altering stitch length

- left button = shortens the length
- right button = elongates the length



**Quick reverse temporary:**

- press the button
- the sewing computer sews stitch pattern in reverse until button is released (max. stitch length 3mm)

**Application:**

- programs buttonholes
- programs darning length
- for switching when in the straight stitch securing program
- manual securing (seam begin and end)

**continuous reverse:**

- press button quickly twice
- the sewing computer sews the chosen stitch in reverse
- press button once to cancel



**Start/Stop button**

- starts and stops the sewing computer when operating it without foot control - the connected foot control is idle

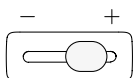

**Speed control**

- to infinitely adjust the speed control when operating the sewing computer via start/stop button



**Needle stop**

Basic setting is needle stop up (arrow points up).

- press the button
- arrow points down = sewing computer stops with needle down (needle in the fabric)
- press button again
- arrow points up = sewing computer stops with needle up



Press button a bit longer = the needle will go automatically up or down.



**Pattern end**

- press the button
- sewing computer stops at the end of a single stitch pattern or stitch combination (in Memory)



**Mirror image (right/left) \*/\*\***

- press the button
- selected stitch pattern will be sewn in mirror image

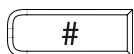

**#-button**

- stitch selection button (see page 24)



**clr» (clear) button**

- press button = reverts to basic settings
- other selected functions are cleared

**Exception:**

- needle stop up/down
- press «clr» button twice to clear altered basic settings of the auto-length buttonhole



**Letters, numbers and characters (330 only Block alphabet)**

- press Alphabet button
- one of the fonts will appear on the screen
- select desired font by pressing the alphabet button
- press the right button to scroll letters and numbers forwards (A B C ...)
- press the left button to scroll letters and numbers backwards (@ Ç ?...)

**Alphabet contents**

ABCDEFGHIJKLMNOPQRSTUVWXYZ  
 Å Ö Ü Ä Æ Ç Ø Ñ È É Ê Æ Å  
 0 1 2 3 4 5 6 7 8 9 0 \_ . ' & ? Ç @



**Memory**

- press the button 2
- «mem» will appear on the display
- the number of available memory spaces (capacity of 30) and the cursor blink
- use the left 1 and right arrow buttons 3 to scroll patterns, letters and numbers
- use the right arrow button 3 to save

**Temporary altered stitch Memory**

- any stitch length or width alterations will be saved automatically

For example:

- sew an altered stitch, e.g. zig-zag
- select and sew another stitch, e.g. straight stitch
- return to zig-zag, your alterations are still active

**Return to basic settings**

- individual stitch patterns can be reverted to basic settings manually
- all altered settings are lost when the «clr»-button is pressed or when the sewing computer is turned off

**Application:**

- for all stitch patterns
- particularly useful for switching between different applications

### Details of the Screen

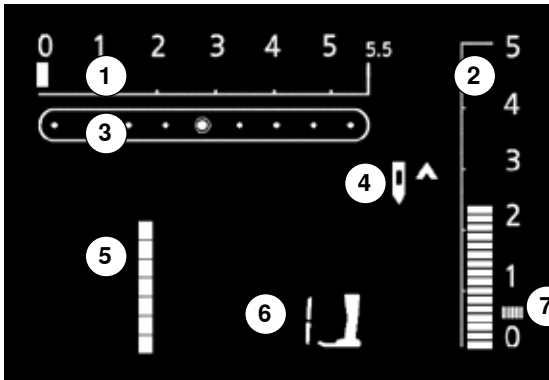

- 1 Stitch width (basic setting always visible - blinks)
- 2 Stitch length (basic setting always visible - blinks)
- 3 Needle position (9 possibilities)
- 4 Needle stop up/down
- 5 Number of stitch pattern
- 6 Number of presser foot (for selected stitch pattern)
- 7 Satin stitch: dense, short zig-zag stitch

## Memory

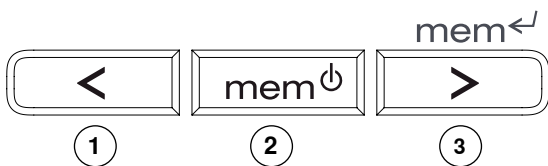

Stitch patterns, letters, and numbers can be combined and stored in memory (capacity of 30 spaces). It's a long-term memory. The contents remain saved until deleted by the user. Power cuts or switching off («0») the sewing computer for a longer time will not affect the saved program. The stitch lengths or widths and the needle position can be changed at any time. Individual stitch patterns, letters or numbers can be deleted or overwritten.

### Memory buttons

- use the left button **1** to scroll the memory contents backwards
- use the center button **2** to open and close the memory
- use the right button **3** for programming the memory and scrolling the memory contents forwards

## Programming Practical and Decorative Stitches

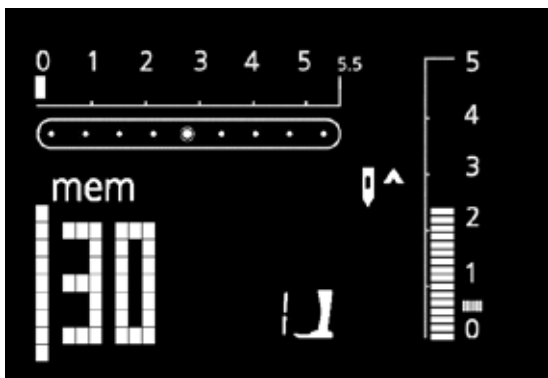

### Opening the memory

- press the button **2**
- the cursor and the available number of empty memory spaces (e.g. 30) start to blink, and «mem» appears
- select desired stitch pattern
- the number of the stitch pattern appears on the display
- press the button **3**
- the stitch is programmed
- the number of available memory spaces appears
- select the next stitch pattern and program as described, etc.

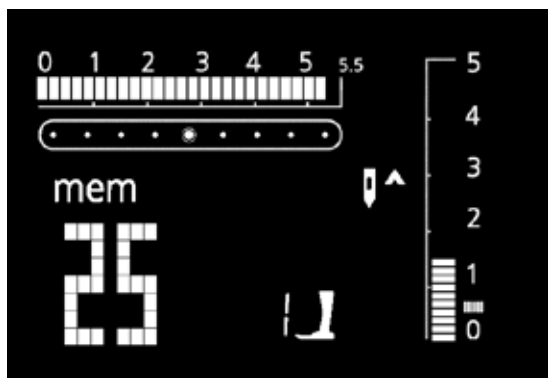

**Starting to sew**

- press the foot control = the sewing computer starts automatically at the beginning of a stitch pattern combination
- select Pattern End as well = the sewing computer stops automatically at the end of a stitch pattern combination



**The following special programs cannot be saved in memory:**

**330:**

- No. 5 Securing program
- No. 10 Buttonhole
- No. 11 Button sewing-on program
- No. 16 Darning program

**350:**

- No. 5 Securing program
- No. 10-11 Buttonholes
- No. 12 Button sewing-on program
- No. 13 Eyelet
- No. 20 Darning program
- No. 21 Basting stitch

**380:**

- No. 5 Securing program
- No. 10-13 Buttonholes
- No. 14 Button sewing-on program
- No. 15 Eyelet
- No. 22 Darning program
- No. 23 Basting stitch

**Programming Alphabets and Numbers**

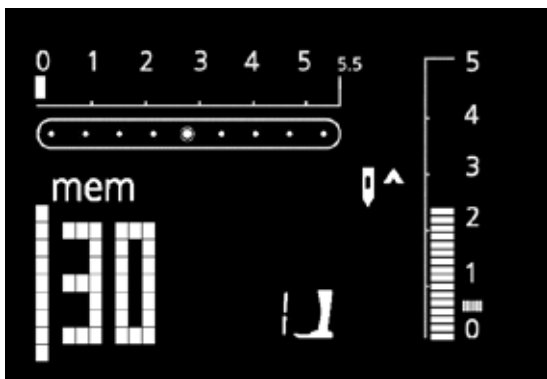
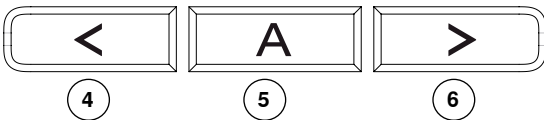

**Opening the memory**

- press the button **2**
- the cursor and the available number of empty memory spaces (e.g. 30) start to blink, and «mem» appears
- press the Alphabet button **5** to select the alphabet of your choice
- the letter A in the alphabet of your choice appears on the display
- use the arrow buttons **4** and **6** to scroll the alphabet
- select letter/number
- press the button **3** = letter/number is programmed
- the number of available memory spaces appears
- proceed as described to select and program more letters and/or numbers
- when programming more than one word, select the underscore symbol ( \_ ) to program a space between the words

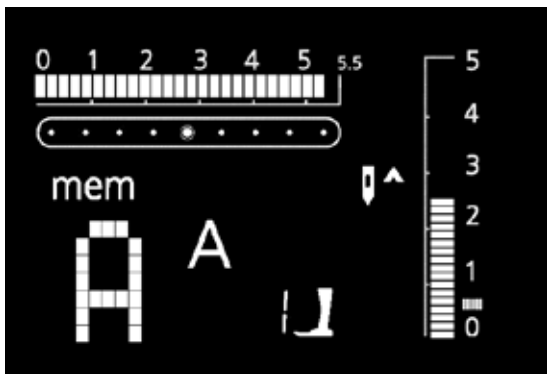

If the stitch length and/or width of letters or numbers have been altered, the alterations will affect all of them. If you only want to alter single letters or numbers, this must be done individually.

## Corrections in Memory

The contents of the Memory remain saved even when the sewing computer is disconnected from the electrical supply. They can be recalled at any time.

The contents of the memory will be lost if the sewing computer is switched off without pressing the button **2** before closing the memory.

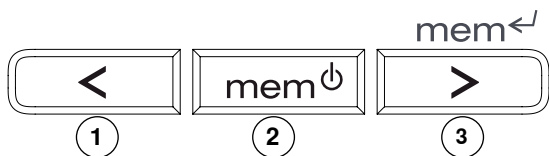

### Overwriting individual stitch patterns, letters and numbers

- scroll with the right **3** or left **1** button to find the stitch pattern you want to overwrite
- select new stitch number/letter/number, new stitch length/width or needle position
- press the right arrow button **3**; the stitch pattern is overwritten

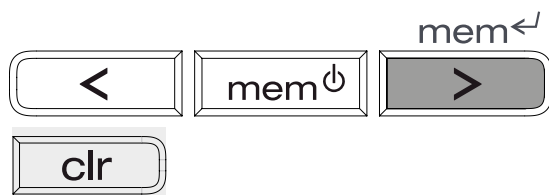

### Deleting individual stitch patterns, letters and/or numbers

- scroll with the right **3** or left **1** button to find the stitch pattern you want to delete
- press the «clr» button
- stitch pattern/letter/number is deleted

## Deleting complete Memory contents



- press the «clr»-button, keep depressed and press the button **2**
- release both buttons
- leave memory by pressing the button **2**
- Memory is now completely deleted

## Leaving the Memory



- press button **2** = contents are saved
- Memory is closed
- «mem» disappears from the display

## Practical Stitches



### Straight stitch

All non-stretch fabrics; all straight-stitch work



### Zig-zag stitch

Most fabric types; all simple zig-zag such as overcasting edges. Sewing on elastic and lace



### Vari-overlock

Primarily for fine jerseys, stretch overlock seams and hems



### Running stitch

Most types of fabric. Mending, patching, reinforcing seams, etc.



### Securing stitch

All types of fabric. Secures the beginning and end of seams sewn with straight stitch



### Triple straight and triple zig-zag

Reinforced seams in firm, heavy fabrics



### Blindstitch

Most types of fabric. Blind hems; shell edging on soft jerseys and fine fabrics; decorative seams



### Double overlock

All types of knit; Overlock = sew and neaten in one operation

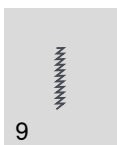

### Super stretch

For super-stretch fabrics; open seam in all super-stretch fabrics



### Gathering stitch

Most types of fabric. Gathering with shirring elastic. Butted seams = butting two pressed edges and sewing together



### Stretch overlock

Mediumweight knits, toweling and firm wovens. Overlock seams, flat joining seams



### Jersey stitch

Natural, blended or synthetic fabrics and delicate knits. Visible seams and hems. Mending jersey/interlock



### Universal stitch

Firm fabrics such as felt and leather. Flat joining seams, visible seams, attaching elastic, decorative seams



### Lycra stitch

All two-way stretch fabrics, flat joining seams and hems, reinforced seaming on underwear



### Stretch stitch

All stretch fabrics; open seam in sportswear

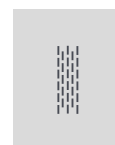

### Darning program

Automatic darning for fine and medium-weight fabrics

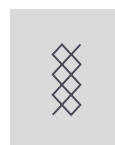

### Honeycomb stitch

Most types of interlock and smooth fabrics; visible seams and hems



## Examples of Application

### Zippers

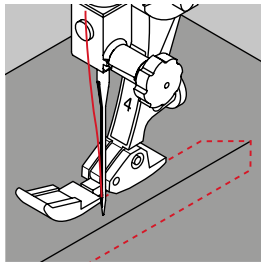

#### Zipper foot/sole No. 4

#### Straight Stitch

##### Preparation

- baste seam closed and clean finish the seam allowance
- baste or pin zipper in place so that fabric folded edges meet over the center of the zipper

##### Sewing

- open zipper a little
- start sewing from top left
- position the foot so the needle stitches along the edge of the zipper coils
- stop in front of the pull (needle position down), raise the presser foot and close zipper again
- continue to sew to the base of the zipper (needle position down)
- turn fabric and sew across the seam (needle position down)
- turn fabric again and sew second side of the zipper from bottom to top

##### Variation: Sew both sides of zipper from bottom to top

- suitable for all fabrics with nap or grain (e.g. velvet)
- prepare zipper as described above
- start sewing in the seam of the zipper end and sew first side from bottom to top
- sew the second side the same way from bottom to top



##### To sew around zipper pull

- close the zipper and sew up to about 2" (5cm) away from the pull
- stop with the needle down in the fabric, raise the presser foot. Open zipper, pulling the tab below the needle; lower presser foot and continue to sew

##### Seam begin

Hold thread firmly when starting to sew = pull fabric slightly to the back (fewer stitches).

##### Zipper or fabric is thick or densely woven

For even stitch formation use a 90 -100 needle.

## Darning

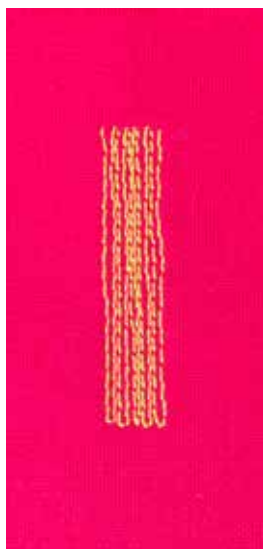

**Reverse pattern foot/sole No. 1**  
**Automatic Buttonhole foot with slide No. 3A**

### Darning program

#### Quick darning of holes or worn areas

Replaces threads along the lengthwise grain in all fabrics.

#### Darning with Reverse pattern foot/sole No. 1 (auto stitch counter)

- insert the needle in the top left of the worn area
- sew the first vertical row and stop the sewing computer
- press the Quick reverse button to program the length
- complete Darning program; the sewing computer stops automatically
- clear the program by pressing the «clr» button

Move project accordingly for a wider and/or longer darning area.

#### Darning with the Automatic buttonhole foot with slide No. 3A

- use for small tears and damaged areas, not more than 3cm (1 1/4") long
- same procedure as with foot No. 1



#### Reinforcement

Use fine fabric or (adhesive) interlining as a backing.

#### Preparation

Hoop fabric into darning ring to prevent puckering.

## Zig-zag

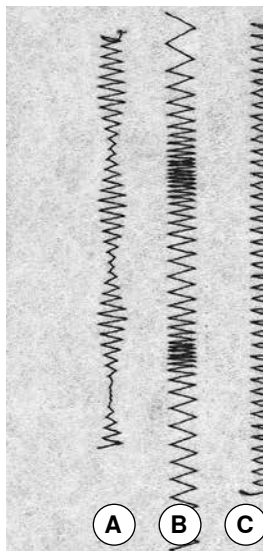

**Reverse pattern foot/sole No. 1**

- for all fabrics
- overcasting
- elastic seams
- decorate sewing

#### Overcasting edges

- guide edge of fabric into the center of the presser foot
- do not select too wide a width or too long a stitch
- needle goes into fabric on one side and over the edge into the air on the other side
- the edge should lie flat and not roll
- use a fine darning thread for lightweight fabric

#### Satin stitch

- dense, short zig-zag stitch (stitch length 0.5-0.7mm, 1/5" to 1/3")
- use satin stitch for appliqué, embroidery, etc

- A** Zig-zag stitch with altered stitch width
- B** Zig-zag stitch with altered stitch length
- C** Edge neatened with zig-zag stitch

## Vari-Overlock

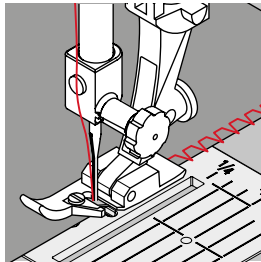

**Overlock foot/sole No. 2**  
**Reverse pattern foot/sole No. 1**

### Vari-overlock stitch

The Overlock foot/sole No. 2 is specifically designed for overlock stitching. The pin on the foot allows for more thread in each stitch so that the elasticity of the seam is maintained.

#### Closed seam

Stretchy seam in fine, soft knits such as silk jersey and interlock.

#### Sewing

- guide the open edge along the pin on the foot/sole
- the stitch will form over the pin and over the edge of the fabric



#### Knits and jersey

Use a new Jersey needle to prevent damaging the loops.

#### Sewing stretch fabrics

If necessary use a stretch needle (130/705H-S) = needle point slides between the fibers.

## Double Overlock

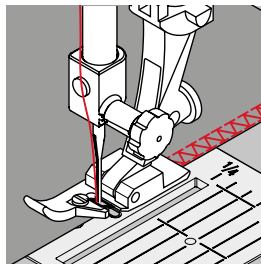

**Overlock foot/sole No. 2**  
**Reverse pattern foot/sole No. 1**

### Double overlock stitch

#### Closed seam

Overlock seam in loose knits and cross seams in knits and jerseys.

#### Sewing

Guide the open edge along the pin on the foot/sole.

## Ribbing with Overlock Stitch

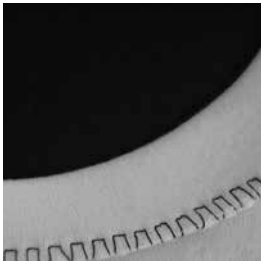

Wrong side of fabric



Right side of fabric

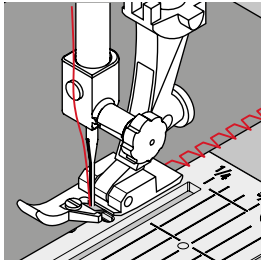

**Overlock foot/sole No. 2**  
**Reverse pattern foot/sole No. 1**

### Vari-overlock stitch

For all fine cotton, synthetic and mixed fiber jersey.

#### Preparation

- fold ribbing in half and press
- with right sides together, pin and baste ribbing to neckline

#### Sewing

- sew Vari-overlock over the raw edge
- guide the open edge along the pin on the foot/sole
- the stitch will form over the pin and over the edge of the fabric



#### Needle stop down

Needle stays in fabric when you stop to adjust the ribbing - great aid when sewing curves (necklines/armholes).

## Honeycomb Stitch Edges

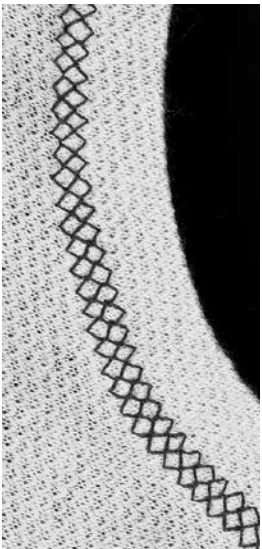

**Reverse pattern foot/sole No. 1**

### Honeycomb stitch

For all firm knits, especially cotton, wool, synthetic and mixed fiber jersey.

#### Preparation

Press (and baste if required) edge 1 cm (3/8") to wrong side.

#### Sewing

- sew from the right at a foot's width from the edge
- trim surplus fabric (wrong side)



#### Needle stop down

Needle stays in fabric when you stop to adjust the ribbing - great aid when sewing curves (necklines/armholes).

## Blind hem

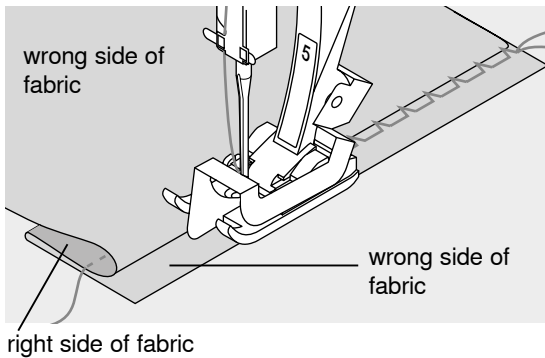
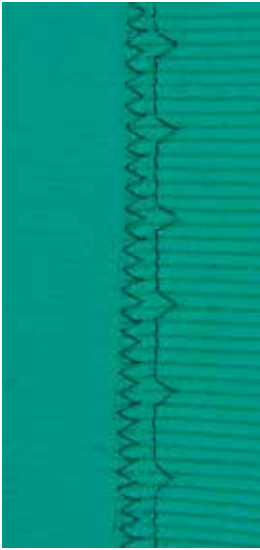

### Blindstitch foot/sole No. 5

#### Blindstitch

For invisible hems in medium to heavy cotton, wool and blended fabrics.

#### Preparation

- finish raw edges
- fold the hem and baste or pin in place
- fold the fabric back over the right side of the fabric to expose the finished lower edge (see drawing)
- place the work under the presser foot with the guide positioned against the folded-back fabric

#### Sewing

- the needle should just pierce the edge of the fold (as when hand blind-stitching)
- adjust the stitch width to suit the fabric thickness
- after sewing about 4" (10cm), check both sides of fabric and adjust width again if necessary
- the metal guide on the sole of the blindstitch sole can be adjusted sideways by turning the screw on the right



#### Fine stitch-width adjustment

Guide the folded edge evenly along the metal guide on the foot = even depth.

## Securing Stitch



### Reverse pattern foot/sole No. 1

#### Securing program

- for all fabrics
- secures beginning and end of seam

#### Sewing long seams

- quicker securing at beginning and end of seam
- even securing by defined stitch count

#### Sew begin

- the sewing computer secures seam automatically (5 stitches forward, 5 stitches reverse)
- then it continues with straight-stitch forward



#### Ending the seam

- press the Quick reverse button on head frame; the sewing computer secures automatically (5 stitches reverse, 5 stitches forward)
- the sewing computer stops automatically when securing is complete

## Buttonhole Summary



**Standard buttonhole**  
Fine to mediumweight woven fabrics; blouses, shirts, trousers, bedlinens, etc.



**Straight-stitch buttonhole**  
Stay-stitch program for bound buttonholes (foot no. 3A) or pocket openings (foot no. 3)



**Stretch buttonhole**  
All stretch fabrics made from cotton, wool, silk and synthetic fibers



**Button sewing-on program**  
For buttons with 2 and 4 holes



**Keyhole buttonhole**  
Heavy weight, non-stretch fabrics. Jackets, coats, trousers, leisure wear, etc.

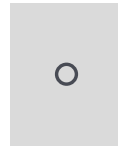

**Straight-stitch eyelet**  
Openings for cords and narrow ribbons, decorative work

## Everything you need to know about buttonholes

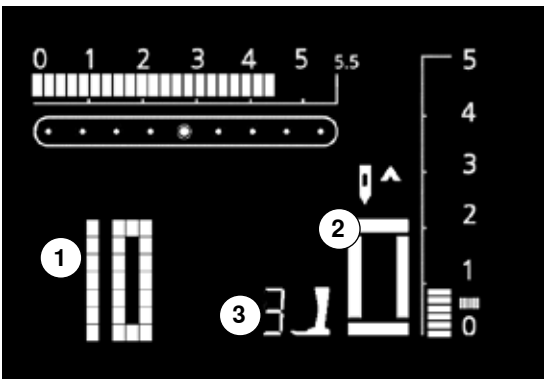

**Buttonholes are not only practical closures, they can also be used to decorative effect**

Select the buttonhole of your choice; the following appears on the screen:

- 1 Buttonhole number
- 2 Buttonhole symbol (blinks)
- 3 Presser foot indicator

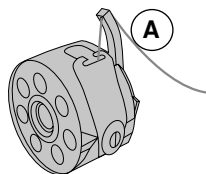

### Thread tension for sewing buttonholes

- thread the bobbin thread through the finger **A** of the bobbin case = the bobbin thread tension is a little tighter
- this gives the beads on the right side of the fabric a slightly rounded appearance
- the buttonhole looks more attractive
- gimp reinforces buttonholes and enhances their appearance (page 38)

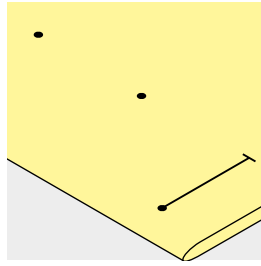
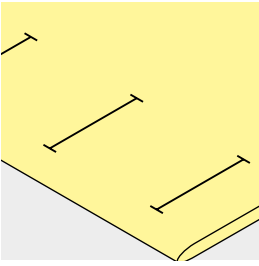

#### Marking the length of manual buttonholes

- mark the buttonhole length in the desired position
- use Buttonhole foot/sole no. 3 \*/\*\*/\*\*

#### Marking the length of automatic buttonholes

- mark the length of just one buttonhole
- after sewing the first buttonhole, the length for all subsequent buttonholes is automatically programmed
- mark only the beginning of all subsequent buttonholes
- use Automatic buttonhole foot with slide no. 3A

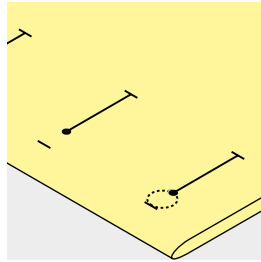

#### Marking the length of keyhole buttonholes

- mark the bead length only
- the correct length eye will be added when the buttonhole is sewn

#### Test sewing

- always sew a test sample on the fabric with stabilizer you intend to use
- select the buttonhole type you intend to use
- sew the buttonhole in the same direction on the fabric (horizontal or vertical, with or against the grain)
- cut the buttonhole open
- push the button through
- adjust the buttonhole length if necessary

#### To adjust the bead width

- alter the stitch width

#### Altering the stitch length

- stitch length adjustments affect both buttonhole beads (spacing between the stitches)
- reprogram the buttonhole length after changing the stitch length

#### Balance for automatic and manual buttonholes

Any balance alterations to the manual and auto-length buttonholes affect both beads identically because they are sewn in the same direction.



If a buttonhole is sewn at right angles to the fabric edge/fold, we recommend the use of the height compensating plates for buttonholes (available as optional accessory). Place the plates from the back between fabric and bottom of slide foot up to the thick part of the fabric and push to front.

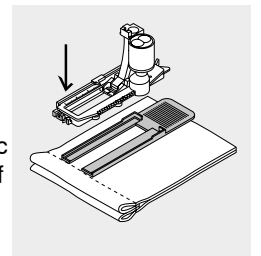

**When all buttonholes have been sewn, return balance to the normal setting!**

## Corded Buttonhole

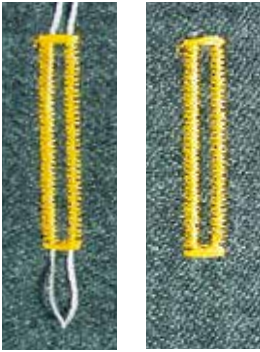

### Cording

- use cording to reinforce buttonholes and enhance their appearance
- the loop of the cord should be at the end of the buttonhole that is most subject to wear = where button is sewn on
- position the work accordingly

### Ideal cords

- Perle cotton no. 8
- strong hand-sewing thread
- fine crochet yarn

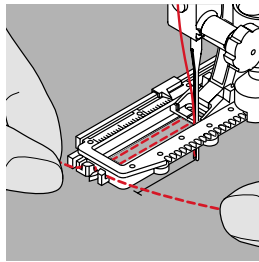
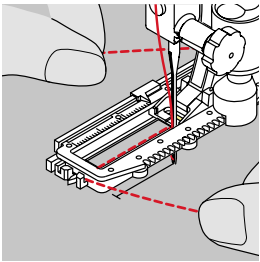

### Hooking the cord in the buttonhole foot with slide no. 3A

- insert the needle at the beginning of the buttonhole
- raise the presser foot
- guide the cord under the foot to the right
- hook the cord over the pin at the back of the foot
- guide the cord back to the front under the foot to the left
- pull the cord ends into the slits

### Sewing

- sew the buttonhole in the usual manner, do not hold the cord
- the buttonhole will form over the cord, covering it

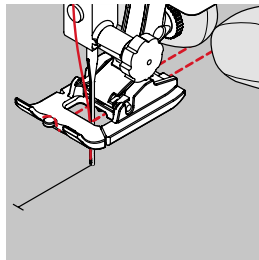
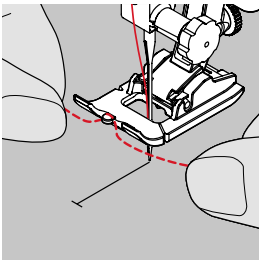

### Hooking the cord onto presser foot no. 3 or buttonhole sole no. 3 \*/\*\*/\*\*\*

- insert the needle at the beginning of the buttonhole
- raise the presser foot
- hook the cord over the center pin on the front of the foot
- place both ends of the cord in their respective grooves on the sole of the foot and pull them to the back
- lower the presser foot

### Sewing

- sew the buttonhole in the usual manner, do not hold the cord
- the buttonhole will form over the cord, covering it

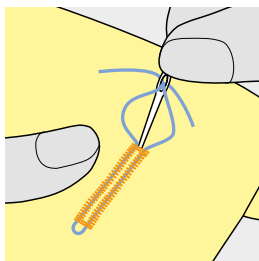

### Securing the cord

- pull the cord through the buttonhole until the loop disappears into the end of it
- pull the ends of the cord through to wrong side of the fabric, using a hand stitching-needle
- knot or secure with stitches



It might be useful to secure the bartack with an extra pin when working short buttonholes.

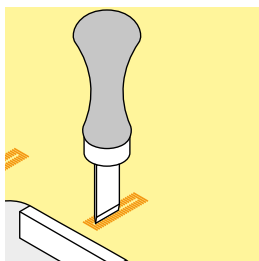
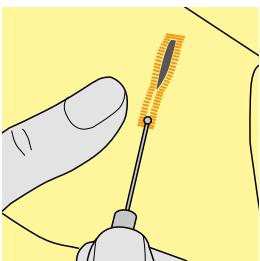

### Cutting buttonholes open with the seam ripper

- using the seam ripper, cut from the ends towards the middle

### Buttonhole cutter and block (special accessory)

- place the fabric on the wood
- place the cutter in the centre of the buttonhole
- press down on the cutter with your hand or a hammer



## Automatic Standard Buttonhole with Auto-Length



### Automatic buttonhole foot with slide No. 3A

#### Automatic standard buttonhole

The lens on automatic buttonhole foot 3A automatically registers the length of the buttonhole for exact duplication.

- the active step blinks on the screen



When any automatic buttonhole is selected, presser foot no. 3 is indicated on the screen.



**The slide foot must lie perfectly flat on the fabric! If the slide foot rests on a seam allowance, the length cannot be measured accurately.**



1

#### Programming the standard buttonhole

- sew the first bead forwards, stop the sewing computer
  - press the Quick reverse button «auto» and the presser foot no. 3A appear on the display = buttonhole length is programmed.



2



3



4



5

the sewing computer sews the following automatically:

- straight stitches in reverse
- the first bartack
- the second bead forwards
- the second bartack and securing stitches
  - the sewing computer stops and returns automatically to buttonhole begin

#### Auto-buttonhole

- all subsequent buttonholes will be sewn to exactly the same length (no need to press the Quick reverse button)
- clear the program by pressing the «clr» button
- the programmed buttonhole can be saved in the long-term memory (refer to page 42)



#### Sewing speed

- sew at moderate speed for best results
- sew all buttonholes at the same speed for a consistent bead density

## Automatic Keyhole Buttonhole with Auto-Length



Automatic buttonhole foot with slide No. 3A

Automatic keyhole buttonhole



1

### Programming the buttonhole

1. sew the straight stitch forward, stop the sewing computer
  - press the Quick reverse button
 «auto» and presser foot no. 3A appear on the screen = buttonhole length is programmed.
2. the sewing computer automatically sews the eye
3. the first bead in reverse
4. straight stitches forwards
5. the second bead in reverse
6. the bartack and securing stitches
  - the sewing computer stops and returns automatically to buttonhole begin

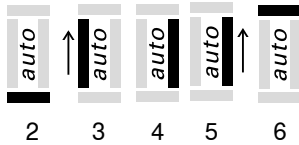

2

3

4

5

6

### Auto-buttonhole

- all subsequent buttonholes will be sewn to exactly the same length (no need to press the Quick reverse button)
- clear the program by pressing the «clr» button
- the programmed buttonhole can be saved in the long-term memory (refer to page 42)



#### Exact duplicates

The auto function ensures that each buttonhole will be exactly the same length as the previous one.

#### Double-sewn keyhole buttonholes

- keyhole buttonholes can be sewn twice on thick fabrics - use a longer stitch length for the first run
- after sewing the first buttonhole, do not move the work
- reduce the stitch length and tap the foot control once to begin sewing again

## Manual buttonhole (all types)



Sewing buttonholes manually is ideal if you only need to sew one; also for repairing existing buttonholes.  
The number of steps depends on the type of buttonhole.  
Manual buttonholes cannot be saved.

### Buttonhole foot/sole No. 3 \*/\*\*/\*\*

#### Preparation

- select the desired buttonhole
- display shows:
- the number of the selected buttonhole
- Buttonhole foot no. 3
- the buttonhole symbol (the first step blinks on the display)
- insert the lower thread in the finger of the bobbin case

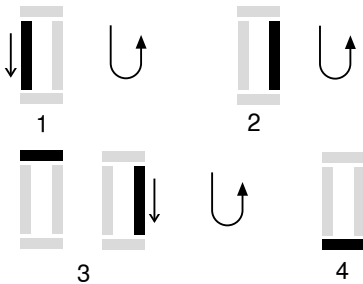

#### Sewing a manual standard buttonhole

1. sew the bead up to the end of the length marking
  - stop the sewing computer
  - press the Quick reverse button
2. sew reverse straight-stitch, stop the sewing computer at the first stitch of the bead (buttonhole begin)
  - press the Quick reverse button
3. sew the top bartack and the second bead, stop the sewing computer
  - press the Quick reverse button
4. sew the bottom bartack and securing stitches

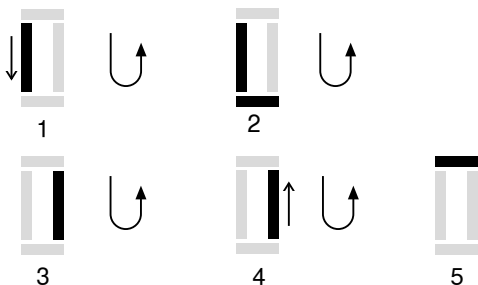

#### Manual keyhole buttonhole

1. sew straight-stitch forwards, stop the sewing computer
  - press the Quick reverse button
2. sew the eye and the first bead in reverse, stop the sewing computer at the first stitch of the bead (buttonhole begin)
  - press the Quick reverse button
3. sew straight-stitch forwards and stop the sewing computer at the keyhole
  - press the Quick reverse button
4. sew the second bead in reverse, stop the sewing computer at the first stitch of the bead (buttonhole begin)
  - press the Quick reverse button
5. sew bartack and securing stitches



Sew both beads at the same speed.

## Buttonhole in Long-Term Memory

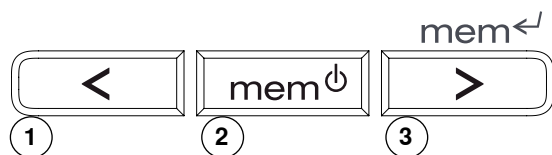

### Saving programmed buttonholes in long-term memory

- after programming press the button 3
- the buttonhole is now saved in long term memory

### Recalling saved buttonhole

Programmed saved buttonholes can be opened for re-use even after the sewing computer has been disconnected.

- select the desired buttonhole type
- press the button 2
- sew the programmed buttonhole
- only one length per buttonhole can be saved. Saving a new length with the button 3 will overwrite the previously saved buttonhole length

## Button Sewing-On Program

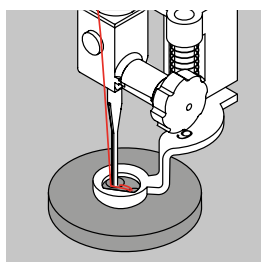
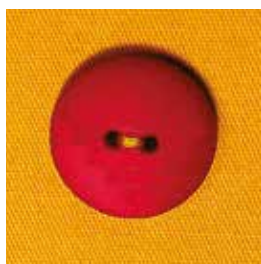

### Darning foot No. 9 \*/\*\*/\*\*\*\*

### Button sew-on foot No. 18 \*/\*\*/\*\*\*\*

Sews buttons with 2 or 4 holes.

### Sewing on buttons

- buttons sewn on for decorative purposes only are stitched without a thread shank
- the length of the shank (= thread between button and fabric) can be made shorter or longer as required with foot no. 18

### Sewing on buttons with Darning foot no. 9

- select Button sew-on program
- check distances between holes with the handwheel and adjust stitch width if necessary
- sew the securing stitches; hold the threads when starting to sew
- sew program
- sewing computer stops automatically when program is completed and is ready for the next button

### Beginning and ending threads

- the threads are secured and can be trimmed

### For secure results

- pull both bobbin thread ends until the ends of the upper thread are visible on the wrong side (knot if required)
- trim thread ends

### Sewing on buttons with foot no. 18

- set the shank length with the screw on the foot
- select Button sewing-on program and continue as with foot no. 9

### Beginning and ending threads

- the threads are secured and can be trimmed

### For secure results

- pull both bobbin thread ends until the ends of the upper thread are visible on the wrong side (knot if required)
- trim thread ends

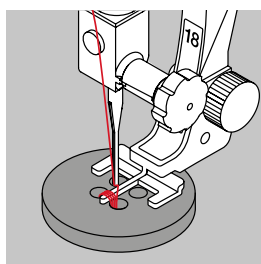

### Sewing 4-hole button

- sew the front holes
- carefully move the button forward
- sew the back holes with the same program

## Basting Stitch



**Darning foot No. 9** \*/\*\*/\*\*

### Basting stitch

- for all work which requires a very long stitch
- for basting seams, hems, quilts, etc.
- temporary joining
- easy to remove

### Preparation

- lower the feed-dog
- pin work at a right angle to basting direction to prevent the layers from slipping

### Basting

- position work under the presser foot and sew one stitch; hold threads when starting to sew
- pull work from behind to the required length of the stitch
- sew one stitch and repeat the procedure



#### Securing/fixing the thread

Sew a few short basting stitches at the beginning and end of a seam.

#### Thread

Use a fine darning thread for basting as it is easier to remove.

## Handlook Quilting Stitch

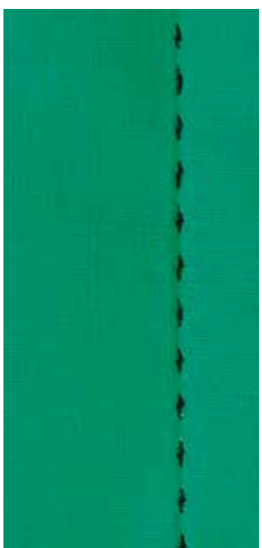

**Reverse pattern foot/sole No. 1**

### Handlook quilting stitch

Suitable for all fabrics and work which should look «hand sewn».

### Test sewing

- the bobbin thread must come through to the right side
- 1 stitch is visible (bobbin thread)
- 1 stitch is invisible (monofilament) = hand-look effect

### Upper thread tension

Depending on the fabric = increase the tension (6-9).

### Balance

Adjust stitch with the Balance if necessary.



#### Perfect corners

- activate Pattern end and Needle stop down and pivot the work
- when pivoting make sure that the fabric does not become distorted

#### Monofilament breaks

- sew more slowly
- reduce upper thread tension slightly

## Cleaning, Maintenance



### Cleaning the screen and the sewing computer

Wipe with a damp cloth.

### Feed-dog area

Clean the sewing computer after every use - remove any lint from under the stitch plate and in the hook area.

- power switch to «0» (off)
- pull out plug from electrical outlet
- remove presser foot and needle
- open the free arm cover
- press the stitch plate down at the back right corner, lift and remove
- clean the area with the lint brush
- replace the stitch plate



### Cleaning the hook

- power switch to «0» (off)
- pull out plug from electrical outlet
- remove the bobbin case
- push the release lever to the left
- let down the locking lever and the black hook race cover
- remove the hook
- clean the hook race with a cloth or brush, never use a sharp instrument
- replace the hook, turning the handwheel if necessary until the hook driver is on the left
- close the hook race cover and secure with the locking lever, the locking pin must engage
- check by turning the handwheel
- insert the bobbin case



### Lubricating

- power switch to «0» (off)
- pull out plug from electrical outlet
- squeeze 1 or 2 drops of oil into the hook race
- run the sewing computer for a short time without thread to prevent oil soiling your work



**Disconnect plug from the socket before cleaning or lubricating!**



**Never use alcohol, petrol, white spirit or any type of solvent to clean the sewing computer!**

## Troubleshooting

In most cases you will be able to identify and remedy faults by checking the following.

### Check whether:

- the upper and lower threads are threaded correctly
- the needle is inserted correctly with the flat side to the back
- the needle size is correct - check the needle/thread table page 22
- the needle tip and shaft are undamaged
- the sewing computer is clean - brush out any thread lint
- the hook race is clean
- any threads are trapped between the tension discs or under the bobbin case spring

Fault	Cause	Repair
<b>Uneven stitch formation</b>	<ul style="list-style-type: none"> <li>■ Upper thread too tight/too slack</li> <li>■ Needle blunt or bent, poor-quality needle</li> <li>■ Needle inserted incorrectly</li> <li>■ Poor-quality thread</li> <li>■ Needle/thread combination is incorrect</li> <li>■ Incorrectly threaded</li> </ul>	<ul style="list-style-type: none"> <li>■ Reduce/increase upper thread tension</li> <li>■ Use new, high-quality needle (BERNINA)</li> <li>■ The flat side of the shank must be to the back</li> <li>■ Use quality threads (Isacord, Mettler, Gütermann)</li> <li>■ Match the needle to the thread size</li> <li>■ Check upper thread threading path/lower thread threading path</li> </ul>
<b>Skipped stitches</b>	<ul style="list-style-type: none"> <li>■ Incorrect needle system</li> <li>■ Needle blunt or bent, poor-quality needle</li> <li>■ Needle inserted incorrectly</li> <li>■ Incorrect needle point</li> </ul>	<ul style="list-style-type: none"> <li>■ Use needle system 130/705 H</li> <li>■ Use new, good quality needles</li> <li>■ Insert needle as far up as it will go</li> <li>■ Match the needle type to the fabric</li> </ul>
<b>Upper thread breaks</b>	<ul style="list-style-type: none"> <li>■ Upper thread tension too tight</li> <li>■ Incorrectly threaded</li> <li>■ Poor-quality or old thread</li> <li>■ Stitch plate or hook tip damaged</li> </ul>	<ul style="list-style-type: none"> <li>■ Reduce upper thread tension</li> <li>■ Check upper thread threading path</li> <li>■ Use high-quality thread</li> <li>■ Have sewing computer checked by a specialized dealer</li> </ul>
<b>Lower thread breaks</b>	<ul style="list-style-type: none"> <li>■ Lower thread tension too tight</li> <li>■ Stitch hole in the stitch plate has been damaged</li> <li>■ Needle blunt or bent</li> </ul>	<ul style="list-style-type: none"> <li>■ Reduce lower thread tension</li> <li>■ Have sewing computer checked by a specialized dealer</li> <li>■ Use new needle</li> </ul>
<b>Needle breaks</b>	<ul style="list-style-type: none"> <li>■ Needle not correctly inserted</li> <li>■ Fabric was pulled</li> <li>■ Fabric was pushed when thick material used</li> <li>■ Poor-quality thread, unevenly wound or knotted</li> </ul>	<ul style="list-style-type: none"> <li>■ Tighten the needle clamp screw</li> <li>■ Do not pull the fabric during sewing</li> <li>■ Use the correct presser foot for thick material (e.g. Jeans foot no. 8, use height compensating tool when sewing over a thick seam)</li> <li>■ Use high-quality thread</li> </ul>
<b>Thread is caught in the area of the take-up lever</b>	<ul style="list-style-type: none"> <li>■ Upper thread breaks</li> </ul>	<p>If the lower thread breaks and the thread is trapped in the area of the take-up lever, proceed as follows:</p> <ul style="list-style-type: none"> <li>■ power switch to «0» (off)</li> <li>■ remove the screw on the headframe with the angular Torx button</li> <li>■ turn headframe cover slightly to the left, then slide it upwards</li> <li>■ remove remnants of thread</li> <li>■ attach headframe and retighten screw</li> </ul>
<b>Faulty stitching</b>	<ul style="list-style-type: none"> <li>■ Remnants of thread between the tension discs</li> <li>■ Incorrect threading</li> <li>■ Remnants of thread under the bobbin case spring</li> </ul>	<ul style="list-style-type: none"> <li>■ Fold a piece of thin fabric and slide the folded edge (not the raw edges) between the thread tension discs, moving the fabric back and forth to clean the right and left side of the thread tension</li> <li>■ Check upper and lower thread</li> <li>■ Carefully remove any thread remnants from under the spring</li> </ul>
<b>Sewing computer</b>	<ul style="list-style-type: none"> <li>■ Sewing computer fails to run or runs slowly</li> </ul>	<ul style="list-style-type: none"> <li>■ Plug not properly inserted</li> <li>■ Power switch to «0» (off)</li> <li>■ Sewing computer has been standing in a cold room</li> </ul>

## Stitch-Pattern Summary

### BERNINA 330

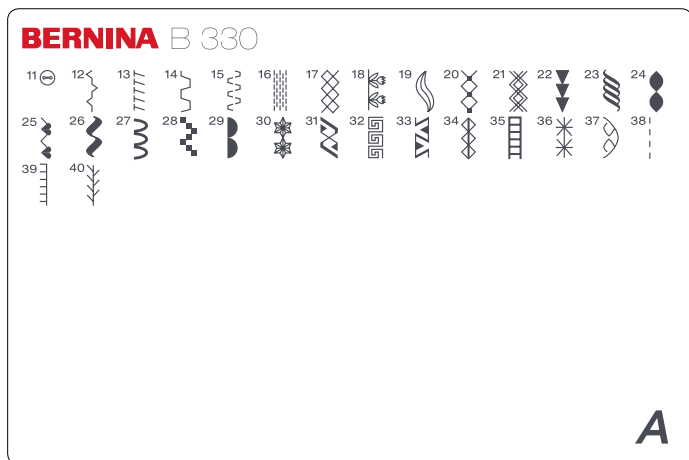

- 11 Button sewing-on program
- 12 Gathering stitch
- 13 Stretch overlock
- 14 Universal stitch
- 15 Lycra stitch
- 16 Darning program
- 17 Honeycomb stitch
- 18-37 Decorative stitches
- 38-40 Quilting stitches

### BERNINA 350/350 Patchwork Edition

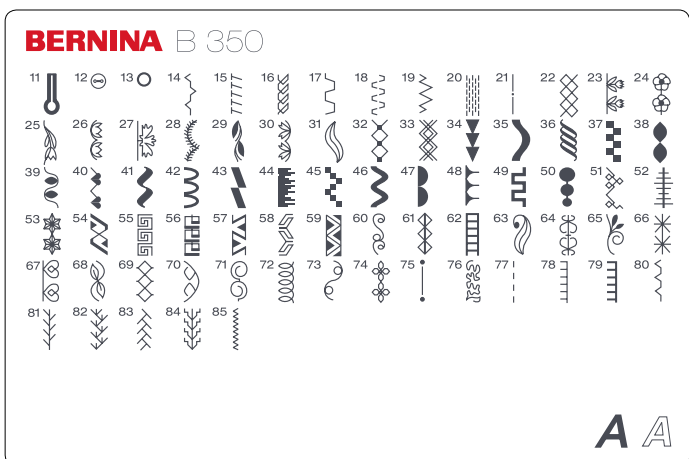

- 11 Keyhole buttonhole
- 12 Button sewing-on program
- 13 Straight-stitch eyelet
- 14 Gathering stitch
- 15 Stretch overlock
- 16 Jersey stitch
- 17 Universal stitch
- 18 Lycra stitch
- 19 Stretch stitch
- 20 Darning program
- 21 Basting stitch
- 22 Honeycomb stitch
- 23-74 Decorative stitches
- 75-85 Quilting stitches

### BERNINA 380

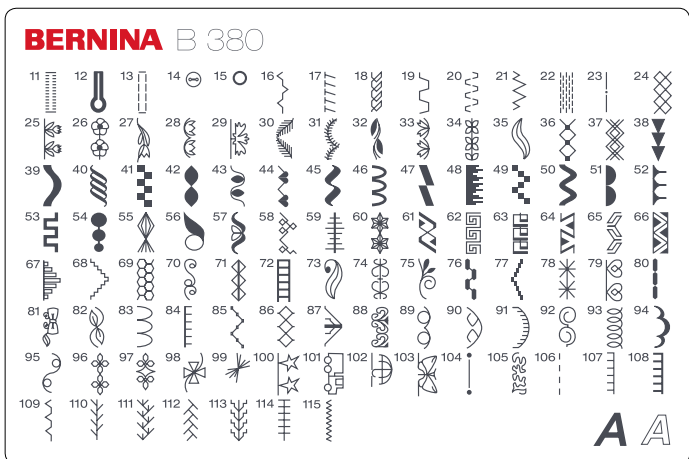

- 11 Stretch buttonhole
- 12 Keyhole buttonhole
- 13 Straight-stitch buttonhole
- 14 Button sewing-on program
- 15 Straight-stitch eyelet
- 16 Gathering stitch
- 17 Stretch overlock
- 18 Jersey stitch
- 19 Universal stitch
- 20 Lycra stitch
- 21 Stretch stitch
- 22 Darning program
- 23 Basting stitch
- 24 Honeycomb stitch
- 25-103 Decorative stitches
- 104-115 Quilting stitches



# Index

## A

<b>Accessory</b>	<b>5-7</b>
<b>Adjusting the stitch width/length</b>	<b>24</b>
<b>Alphabets/characters</b>	
■ Changing the size of lettering	28
■ Combining	28
■ In long-term memory	42
■ Selecting	9, 25, 28
■ Sewing	28
<b>Automatic Buttonhole</b>	
■ Foot with slide 3A	6
■ Programming	39-40
<b>Automatic functions</b>	
■ Darning	32
■ Needle stopp	9, 25
■ Pattern end	9, 25

## B

<b>Balance</b>	<b>19</b>
■ Buttonholes	19, 37
■ Decorative stitches	19
<b>Basting</b>	<b>43</b>
<b>Blind stitch</b>	
■ Practical stitch	30, 35
■ Presser foot	6
<b>Bobbin</b>	
■ Removing/inserting the bobbin	12
■ Winding	12
<b>Bobbin case</b>	
■ Removing/inserting	13
<b>Button sew-on program</b>	<b>42</b>
<b>Buttonhole</b>	
■ 4-steps	41
■ 5-steps	41
■ Automatic	39-40
■ Balance	37
■ Buttonhole type	36
■ Cutting open	38
■ Important information	36-37
■ In long-term	42
■ Manual	41
■ Presser feet	6
■ Programming	39
■ Stabilizers	38

## C

<b>Carrying handle</b>	<b>9</b>
<b>Change</b>	
■ Letter size in alphabets	28

■ Programmed buttonhole	42
■ Sewing speed	10, 25
■ Stitch patterns	27
■ Stitch width and length	9, 24, 28
■ Thread tension	9, 18, 36

<b>Cleaning</b>	<b>44</b>
-----------------	-----------

### Combining

■ Alphabets	28
■ Correcting	29
■ Deleting	29
■ Practical-/decorative stitches	27
■ Saving	27-28

<b>Contents</b>	<b>4</b>
-----------------	----------

## D

<b>Darning</b>	<b>30, 32</b>
----------------	---------------

<b>Decorative Stitch patterns</b>	<b>46</b>
-----------------------------------	-----------

■ Summary	46
-----------	----

### Deleting

■ clr	25
■ Combinations	29
■ Stitches	29

### Details

■ Accessory	5
■ Sewing computer	8-9

### Display

■ Overview	26
------------	----

### Double and triple needles

■ For decorative stitching	23
■ Threading double and triple needles	15

## E

<b>External function buttons</b>	<b>9, 24-25</b>
----------------------------------	-----------------

## F

### Fabric

■ Feed	20
■ Needle and thread	22

### Fabric feed

	<b>20</b>
--	-----------

### Feed-dog

■ Position	20
■ Raising/lowering the feed-dog	20

### Foot control

■ Connection	9
--------------	---

<b>Free Hand System (FHS)</b>	<b>5, 9, 11</b>
-------------------------------	-----------------

**H**

<b>Handwheel</b>	<b>9</b>
<b>Hem</b>	
■ Blind hem	35
<b>High compensation tool</b>	<b>5, 21</b>

**I**

<b>Inserting a bobbin</b>	<b>12</b>
---------------------------	-----------

**L**

<b>LED sewing light</b>	<b>10</b>
<b>Lettering size</b>	<b>28</b>
<b>Long Term Memory</b>	<b>27, 42</b>
<b>Lubricating</b>	<b>44</b>

**M**

<b>Main power switch</b>	<b>9</b>
<b>Maintenance and troubleshooting</b>	<b>44-45</b>
■ Cleaning	44
■ Maintenance	44
■ Troubleshooting	45
<b>Manual threading</b>	
■ Double and triple needles	15
■ Lower thread	12
■ Upper thread	14
<b>Memory</b>	
■ Modifications	29
■ Opening	27, 28
■ Stitch combinations	27
<b>Mirror-image function</b>	
■ Left/right	25

**N**

<b>Needle</b>	
■ Altering the needle position	24
■ Changing the needle	16
■ Double and triple needles	15, 23
■ In standard accessory	5
■ Information	22
■ Needle stop up/down	25
■ Needle summary	23
■ Needle/thread combination	22
■ Position button	24
■ Threading	14
<b>Needle clamp</b>	<b>9</b>

**O**

<b>Overlock</b>	
■ Overlock foot	6
■ Seam	33-34
■ Stitches	30
<b>Overwriting</b>	<b>29</b>

**P**

<b>Patchwork</b>	
■ Special Feet	6
<b>Permanent reverse Sewing</b>	<b>25</b>
<b>Power cable</b>	
■ Connection	9
<b>Practical stitches</b>	
■ Adjusting individual	24
■ Brief Description	30
■ Overview	30
<b>Preparing and setting up</b>	
■ The sewing computer	8-23
<b>Presser foot</b>	
■ Changing the presser foot	17
■ Display	26
■ Presser feet summary	6
■ Raise/lower the presser foot	9, 11
<b>Pre-tension</b>	<b>9</b>

**Q**

<b>Quilting</b>	
■ Stitches	43, 46

**R**

<b>Reverse sewing</b>	
■ Button	9, 25
■ Permanent reverse sewing	25
<b>Running stitch</b>	<b>30</b>

**S**

<b>Safety instructions</b>	<b>2</b>
<b>Saving</b>	
■ Function button	25
■ Saving stitch pattern combinations	27, 28
<b>Select</b>	
■ Alphabets	9, 25, 28
■ Buttonholes	36, 46
■ Practical stitches	30, 46
■ Quilting stitches	46
■ Stitch patterns	24, 46
<b>Servicing</b>	<b>44</b>

**Sewing**

- Accessory 5
- Balance 19
- Basic settings 26
- Content 4
- Function buttons 24-25
- Reverse sewing/Backstepping 25
- Sewing corners 21
- Sewing pattern combinations 28
- Stitchcategory 46
- With height compensation plates 21

**Sewing computer cover** 5

**Sewing light LED** 10

**Sewing speed** 10, 25

**Single pattern**

- Changing in pattern combination 29
- Deleting 29
- Securing 25
- Selection by number 24

**Slide on table** 5, 9, 10

**Speed control** 9, 25

**Spool discs** 5

**Spool holder** 9, 11

**Start-Stop Button** 9, 25

**Stitch pattern**

- Buttonholes 36, 46
- Decorative stitches 46
- Display 26
- Functions 25
- Overview 46
- Practical stitches 30, 46
- Quilt stitches 46

**Stitch pattern selection**

- By number 24

**Stitch plate**

- Attaching/removing 18

**Stitchcategory** 46

**Straight stitch** 30

**Summary**

- Screen 26
- Sewing computer 8-9
- Sewing functions 25
- Stitch patterns 46

**T**

---

**Thread**

- General facts 22
- Matching fabric, thread and needle 22

**Thread cutter**

- For bobbin thread 13
- For bobbin winder 9, 12
- On Head Frame 9, 16

**Thread path/Thread guides** 9

**Thread take up cover** 9, 14

**Thread tension** 9, 18

**Triple Needle** 15, 23

**Triple Straight Stitch** 30

**Troubleshooting** 45

**U**

---

**Upper thread**

- Breaks 45
- Tension 18
- Threading 14

**W**

---

**Winder**

- Pre-tension 9
- Switching on/off 12

**Z**

---

**Zig-zag stitch** 30, 32

**Zipper**

- Inserting a zipper 31
- Zipper foot 6

**Text**

Herbert Stolz

**Graphics**

[www.sculpt.ch](http://www.sculpt.ch)

**Fotos**

Patrice Heilmann, CH-Winterthur

**Typesetting, Layout**

Susanne Ribl/Erika Vollenweider-Czibulya

**Copyright**

2009 BERNINA International AG, CH-Steckborn

**All rights reserved**

For technical and product improvement reasons, the sewing computer's features, parts and accessory are subject to unannounced changes and alterations at any time. The accessory included can differ from country to country.

