

**Thermo Scientific
Shandon Cytospin® 4 Cyto centrifuge**



Thin-layer Cell Preparation System

Thermo Scientific Shandon Cytospin® 4 Cyto centrifuge

The ultimate thin-layer cell preparation system.

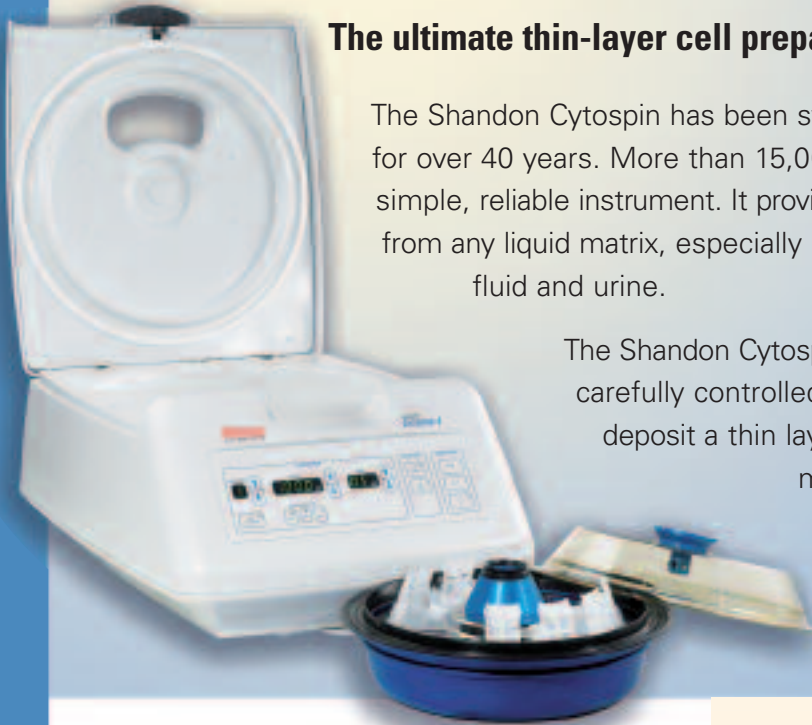

The Shandon Cytospin has been synonymous with cyto centrifugation for over 40 years. More than 15,000 laboratories worldwide use this simple, reliable instrument. It provides economical thin-layer preparations from any liquid matrix, especially hypocellular fluids such as spinal fluid and urine.

The Shandon Cytospin was the first device to use carefully controlled centrifugation to separate and deposit a thin layer of cells on slides while maintaining cellular integrity. It produces better cell capture and good representation of all cell types present in homogeneous liquid samples.

Features

- Processes 12 specimens at one time.
- Accepts all protocols from Shandon Cytospin 1, 2, and 3.
- Redesigned lid-release mechanism allows for one-handed opening and closing of the outer lid for easy access. As an added safety measure, the Shandon Cytospin 4 will only operate when the lid is locked into position. The lid remains locked at all times during rotation. The polycarbonate window allows the operator to see the sealed head during cyto centrifugation.
- Excellent safety design prevents accidental fluid spillage from damaging the mechanical or electronic components and allows for easy disinfecting. It meets stringent IEC 61010 standards for centrifuge safety.
- Pull-out program card allows for up to nine programs to be logged for fast and convenient retrieval (erasable ink pen included).

Safe and Reliable

The Shandon Cytospin 4 is designed to protect the operator before, during and after sample preparation. Safety is our top priority. The ability to load the Shandon Cytospin 4 sealed head in a microbiological cabinet is the ultimate safety procedure.

- Auto-locking, plastic outer lid
- Autoclavable sealed head
- Disposable sample chambers with caps
- Safety alarms that protect users and specimens
- Wipe-clean control panel

Simple Principle for Excellent Presentation

Using centrifugal principles, the Shandon Cytospin deposits cells onto a clearly-defined area of a glass slide and allows for the absorption of the residual fluid into the sample chamber's filter card (except Shandon EZ Megafunnel). Cyto centrifugation also constructively flattens cells for excellent nuclear presentation. During operation, the instrument's spinning action tilts the Shandon Cytofunnels® upright and centrifuges cells onto the deposition area of the slide, giving all cell types equal opportunity for presentation. In the Load or Stop position, this unique tilting feature reduces cell loss by preventing residual fluid from coming into contact with the prepared slide.

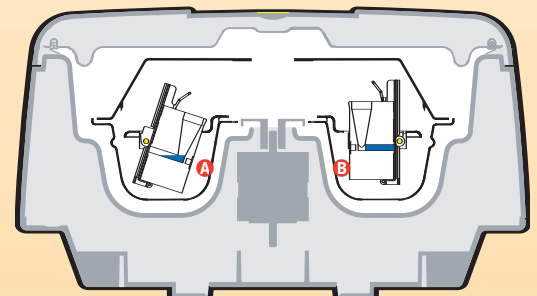

- A** In Load Position (Stopped)
- B** In Operation (Spin)

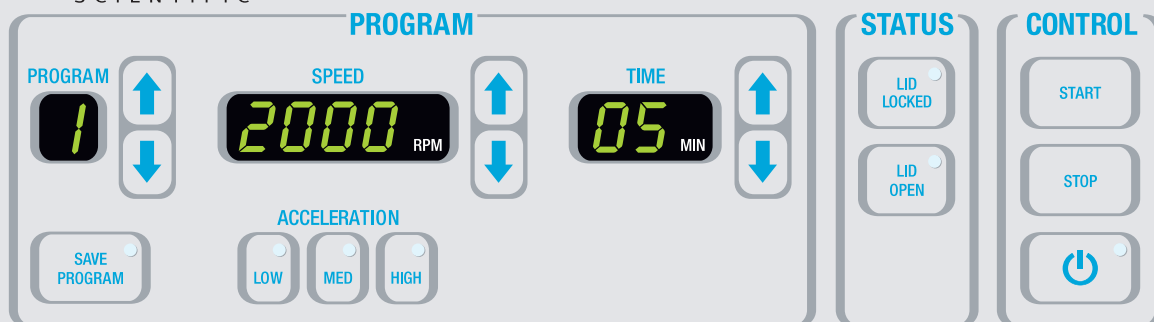

Simple and Precise Controls

- Protected program memory stores up to 23 routines for instant recall and protects from power loss.
- Program key pad has “easy-touch” design that allows for easier keystrokes and more intuitive programming.
- Speed window displays the programmed spinning speeds from 200 – 2000 rpm.
- Three acceleration control buttons allow the operator excellent flexibility and exceptional protection for fragile samples.
- Time window displays the programmed and remaining run time from 1– 99 minutes.
- Control feature has a standby power saving mode. Displays are also turned on and off by the standby key.
- Specimen safety alarm feature has been added to remind users at one-minute intervals to remove specimens, protect them from “air-drying” and ensure consistent results.
- Safety alarms include an audible alarm that signals the operator if the Shandon Cytospin 4 is out of balance, outside the speed tolerance, or if the lid is not properly locked. As an extra measure of safety for the user, the unit will not spin if the lid is not locked.

Shandon Cytospin 4 Specifications

Description	Order Number
Shandon Cytospin 4 Cytocentrifuge (Unit Only)	A78300002
Shandon EZ Funnel Starter Kit	A78710013
Includes 25 Shandon EZ Megafunnels™, 20 Shandon EZ Single White Cytofunnels®, 20 EZ Double Cytofunnels, and Shandon Cytoslides®	
Shandon Clipped Funnel Starter Kit	3120110
Includes 25 Shandon EZ Megafunnels, 50 Shandon Single White Cytofunnels®, 25 Double Cytofunnels, Shandon Cytoslides, and 12 Shandon Cytoclips®	

Physical Specifications

Dimensions (H x W x D)

With Closed Lid: 9.5" x 16" x 24.5" (24 x 40.5 x 62cm)

With Opened Lid: 25" x 16" x 24.5" (62.5 x 40.5 x 62cm)

Weight

26.5 lbs. (12 kg)

Power Requirements

100-240 VAC, 50/60 Hz, 1 Ph, 150 VA Max

Included with Product*	Pkg/Qty	Order Number
Sealed Head/Rotor	Each	59910018
Marking Pen	Each	AP14891
Operator Manual (specify language)	Each	A78310250
Service Record Book	Each	A78410106
Standard Workflow Diagram	Each	A783-1001

* Contents, Packaging, and Quantities of items listed under “Included with Product” are subject to change without prior notice.

Additional Accessories	Pkg/Qty	Order Number
Service Manual	Each	A78310251
Sealed Head Seals	3 / Pk.	59910019
Shandon Cytofunnels		See pages 4-7
Glass Microscope Slides		See page 9.

Agency Approvals

IEC 61010, CSA, UL, and CE Mark (IVDD compliant).

Shandon Cytospin 4 Sealed Head

- One sealed head is included with the Cytospin 4, but many laboratories shorten preparation time by having a second sealed head ready for when the first finishes processing.
- Autoclavable, 12-chamber head seals completely.

Description	Pkg/Qty	Order Number
Shandon Cytospin Sealed Head	Each	59910018



Thermo Scientific Shandon EZ Cytofunnel® Sample Chambers

No more Clips!!

- Intended for single use with all Shandon Cytospin 2, 3, and 4 Cyto centrifuge applications.
- Simple and easy to use operational illustrations are included in the package.
- Optimizes cell yield.
- Safe – reduces the risk of exposure to pathogenic samples.
- Disposable – eliminates time-consuming decontamination and cleaning.
- Decreases the possibility of cross-contamination.
- Eliminates the need for metal Shandon Cytoclips®.
- Closure caps provided with kit.
- Produces more cost-effective thin-layer preparations when compared to other thin-layer methods.



Shandon EZ Cytofunnel Bench Stand

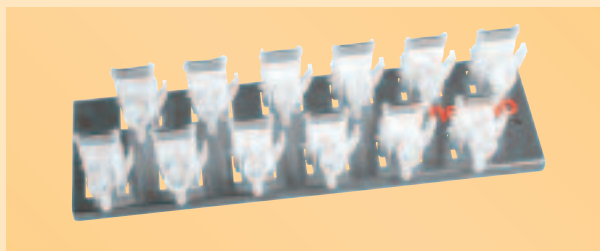

- Convenient for loading samples outside of the Shandon Cytospin 4 chamber.
- Stainless steel construction.
- Holds 12 Shandon EZ Cytofunnels, single or double.

Description	Pkg/Qty	Order Number
Shandon EZ Cytofunnel Bench Stand	Each	A78710022

Shandon EZ Megafunnel™

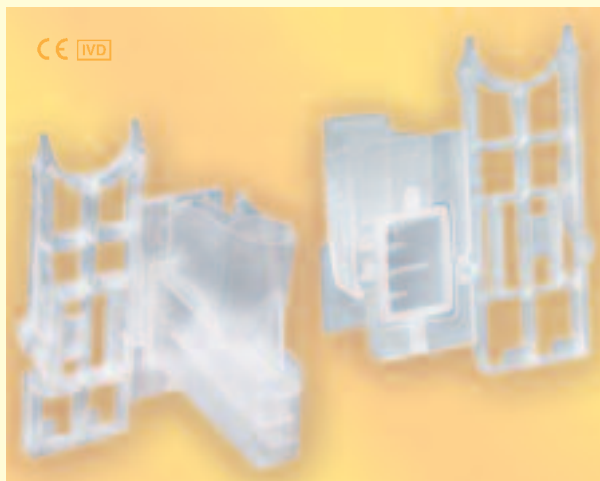

- Designed for convenient preparation of larger volume samples.
- Shandon Cytofunnels designed for spinning large samples up to 6ml.
- Minimizes the need to pre-centrifuge.
- Cell deposition area of 22 x 14.75mm (325mm²) for increased cell yield.
- Shandon Megafunnel Cytoslides® included.
- Can prepare both air-dried and fixed preparations, providing additional valuable diagnostic information.

Description	Pkg/Qty	Order Number
Shandon EZ Megafunnel With Caps And Slides	25 / Box	A78710001

Shandon EZ Single Cytofunnel with White Filter Cards



- Disposable sample chambers with white filter cards.
- Use for sample volumes up to 0.5ml.
- Cell deposition area of 6mm in diameter (28 mm²).
- Pre-attached white filter card for high absorbency.

Description	Pkg/Qty	Order Number
Shandon EZ Single Cytofunnel With White Filter Cards and Caps	40 / Box	A78710003
Shandon EZ Single Cytofunnel With White Filter Cards and Caps	200 / Pk.	A78710020

Shandon EZ Single Cytofunnel with Brown Filter Cards



- Disposable sample chambers with brown filter cards.
- Use for sample volumes of 0.4 ml or less.
- Cell deposition area of 6mm in diameter (28mm²).
- Pre-attached brown filter card for slower absorbency.
- Excellent for scanty specimens such as CSF.

Description	Pkg/Qty	Order Number
Shandon EZ Single Cytofunnel With Brown Filter Cards and Caps	40 / Box	A78710004

Shandon EZ Double Cytofunnel



- Disposable sample chambers.
- Allows 2 sample deposition areas on a single slide.
- Double the number of sample presentations per run.
- Funnel markings correspond to slide markings for simple identification.
- Pre-attached filter card.

Description	Pkg/Qty	Order Number
Shandon EZ Double Cytofunnel With White Filter Cards and Caps	40 / Box	A78710005
Shandon EZ Double Cytofunnel With White Filter Cards and Caps	200 / Pk.	A78710021

Thermo Scientific Shandon Cytofunnel® Sample Chambers

The original is still the most trusted clipped funnel available today.

Shandon Single Cytofunnel

with White Filter Cards



- Disposable sample chambers with white filter cards.
- Use for sample volumes up to 0.5ml.
- Pre-attached filter card.

Description	Pkg/Qty	Order Number
Shandon Single White Cytofunnels With Caps	50 / Box	5991040
Shandon Single White Cytofunnel Economy Pack With Caps	500 / Case	1102548

Shandon Single Cytofunnel

with Brown Filter Cards



- Disposable sample chambers with brown filter cards.
- Use for sample volumes of 0.4ml or less.
- Pre-attached filter card.
- Excellent for scanty specimens such as CSF.
- Increases cell yield.

Description	Pkg/Qty	Order Number
Shandon Single Brown Cytofunnels With Caps	50 / Box	5991043

Shandon Double Cytofunnel

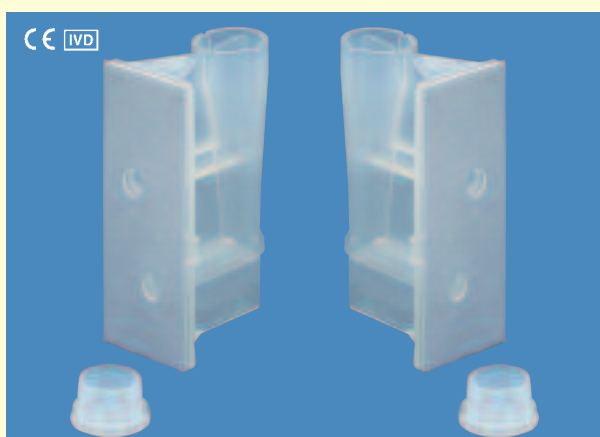

- Disposable Sample Chambers.
- Reduce preparation time.
- Funnel markings correspond to slide markings for simple identification.
- Pre-attached filter card.
- Ideal for use with immunochemistry techniques.

Description	Pkg/Qty	Order Number
Shandon Double White Cytofunnel With Caps	25 / Box	5991039
Shandon Double White Cytofunnel Economy Pack With Caps	500 / Cs.	1102547

Shandon Cytoclip™

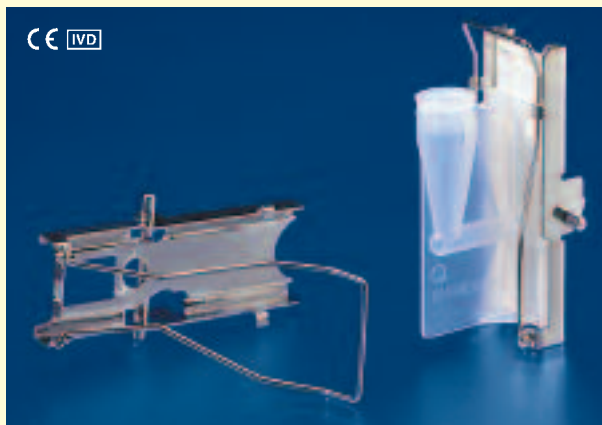

- Shandon Cytoclip holds Cytofunnel® disposable sample chamber against the microscope slide for preparation in the Shandon Cytospin Cyto centrifuge.
- Eliminates contact between contaminated Shandon Cytofunnels and laboratory personnel.
- Clips are autoclavable and reusable.

Description	Pkg/Qty	Order Number
Shandon Cytoclip Stainless Steel Slide Clip	6 / Box	59910052

TPX® Single Sample Chamber, Caps, and Filter Cards

TPX Single Sample Chamber and Caps

- Reusable and autoclavable.
- Choice of using disposable white filter cards for sample volumes up to 0.5ml or disposable brown filter cards for sample volumes of 0.4ml or less.



Filter Cards

- Highly absorbent disposable filter cards for use with TPX chamber.
- Not for use with Cytofunnel disposable sample chambers.
- Use white filter cards for samples up to 0.5ml.
- Use brown filter cards for samples of 0.4ml or less.

Description	Pkg/Qty	Order Number
TPX Sample Chamber	12 / Pk.	A78710018
Sample Chamber Closure Caps, For Shandon TPX Chambers	12 / Pk.	59910025
Brown Filter Cards	200 / Box	5991023
White Filter Cards	200 / Box	5991022

How the Cytofunnel Works

The Cytofunnel fits snugly against a specially marked Cytoslide and is held in place by a Shandon Cytoclip. Twelve Shandon Cytoclip assemblies fit into the Cytospin head.

After cyto centrifugation, the Shandon Cytoclip easily unlocks to dispose of the sample chamber and to remove the slide.

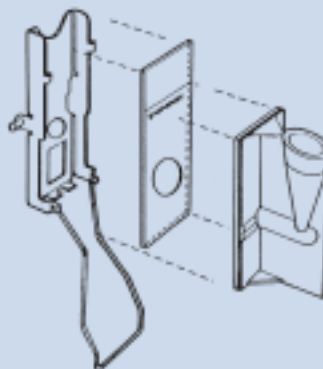

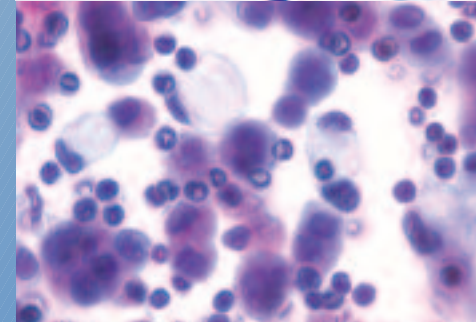
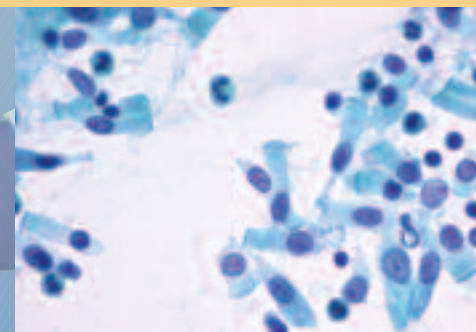

Disciplines That Use the Cytospin:

Cytology

- Still the gold standard for Non-Gynecological Cytology, especially hypocellular fluids.
- Many types of collection fluids and funnel options to choose from.
- Quality presentation at a fraction of the cost of other "thin-layer" technologies.
- Prepares both "air-dried" and "fixed" specimens.

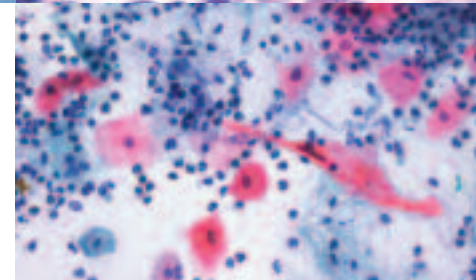

Microbiology

- Micro-organisms are often present in low numbers from limited sample volumes. Cyto-centrifugation effectively spins the micro-organisms onto the slide, maximizing the yield and presenting those organisms in a clean, defined area, allowing for straightforward morphological identification.
- Only a small sample volume is needed so multiple samples may be run for a variety of special staining and support testing. It also concentrates samples for Gram stains.

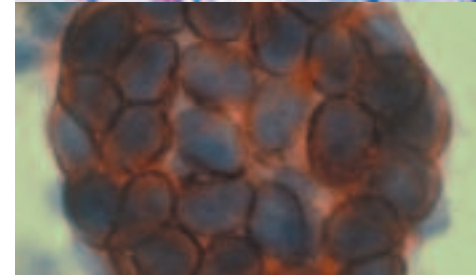

Hematology/Oncology

- Easy to achieve a constant cell/unit volume.
- Excellent for all fluids, bone marrow, and peripheral blood.
- Even with a cell count of "zero," the Cytospin often locates the few cells in the fluid that the counter missed.

Virology

- There are many published technical papers utilizing the Cytospin for the rapid detection of respiratory viruses, CMV Detection, ISH, FISH, etc.

Research/General Use

- The most cost-effective, time-effective way to make quality thin-layer cell presentations.
- Excellent for molecular studies, specialized staining applications, and EM.
- Used in veterinary, dental and chemosensitivity protocols.



Thermo Scientific Shandon Cytoslides®

Cytoslides

- Specially marked slides for the Shandon Cytospin 4.
- Specimen area is outlined for rapid location during screening.
- All slides are 75 x 25mm, made from high-quality optical glass.

Coated Slides

- Eliminates the need for albumin coating procedures.
- Saves labor and resource time.
- Eliminates background staining on albuminized, IHC or ISH processed slides.

Shandon Double Cytoslides



- Specially made for use with Shandon EZ Double Cytofunnel® Chambers.
- Each specimen is displayed onto the slide within a circle marked "1" or "2" which corresponds with the Shandon EZ Double Cytofunnel chamber.

Description	Pkg/Qty	Order Number
Shandon Cytoslide, Double Circle, coated	100/box	5991055
Shandon Cytoslide, Double Circle, non-coated	100/box	5991054

Shandon Single Cytoslides



- Specially made for use with Shandon EZ Single Cytofunnels.
- A white, 12mm diameter circle on the slide defines the area where cells will be displayed to allow for efficient and rapid location.
- Uncoated slides available with circle on front or back.

Description	Pkg/Qty	Order Number
Shandon Cytoslide, Single Circle coated with circle on back	100/box	5991056
Shandon Cytoslide, Single Circle non-coated with circle on back	100/box	5991051
Shandon Cytoslide, Single Circle non-coated with circle on front	100/box	5991059

Shandon Mask Cytoslides



- Specially produced for immunofluorescence.
- Black-coating masks out UV light so that only the specimen within the circle can be viewed through a microscope.

Description	Pkg/Qty	Order Number
Shandon Cytoslide, Single Circle, Black mask	100/box	5991057
Shandon Cytoslide, Double Circle, Blue mask	100/box	B5991050

Thermo Scientific Shandon Cytology Collection Fluids

Shandon Cytospin® Collection Fluid



- Ready-to-use alcohol/CARBOWAX® (PEG) combination for direct specimen collection and fixation.
- Permits storage of specimens or unstained slides for weeks without adverse effect.
- Packaged in several forms, including convenient pump bottle and pre-filled specimen cups.

Description	Pkg/Qty	Order Number
Shandon Cytospin Collection Fluid	3.8L x 1 (with pump)	6768001
Shandon Cytospin Collection Fluid	500ml x 2	6768315
Shandon Cytospin Collection Fluid	10L x 2	9990310
Shandon Cytospin Collection Fluid	120ml Cups, filled to 60ml, 125 / Cs.	9990323

Shandon Cell-Fixx™ Spray Fixative



- Spray fixative for convenient preparation of slides.
- Includes CARBOWAX which coats the smear to maintain cellular detail.
- Prevents air-drying artifact and cell loss.

Description	Pkg/Qty	Order Number
Shandon Cell-Fixx	50ml Pump Spray Bottle x 6	6768326

CytoRich® Red Collection Fluid (Concentrated Formula)



- Ready-to-use alcohol-based fluid.
- The easiest way to lyse RBC's and to solubilize proteins.
- For a higher cell-yield and a cleaner background.
- Compatible with immunohistochemistry.
- Pre-filled containers available.

Description	Pkg/Qty	Order Number
CytoRich Red Collection Fluid	3.8L x 1	B9990800
CytoRich Red Collection Fluid	500ml x 2	B9990801
CytoRich Red Collection Fluid	20ml Cups, filled to 10ml, 180 / Cs.	B9990802
CytoRich Red Collection Fluid	120ml Cups, filled to 60ml, 125 / Cs.	B9990803

Shandon Mucolexx™



- Ready-to-use mucoliquifying preservative.
- Liquifies (with agitation) mucoid cytology specimens.
- Maintains cellular detail.
- Short term preservation of specimens.

Description	Pkg/Qty	Order Number
Shandon Mucolexx	3.8L x 1	9990371
Shandon Mucolexx	500ml x 4	9990370
Shandon Mucolexx	120ml Cups, filled to 60ml, 50 / Cs.	9990375

Thermo Scientific Shandon Cytology Stains

Biological Stain Commission Certified Dyes.

Shandon EA-50

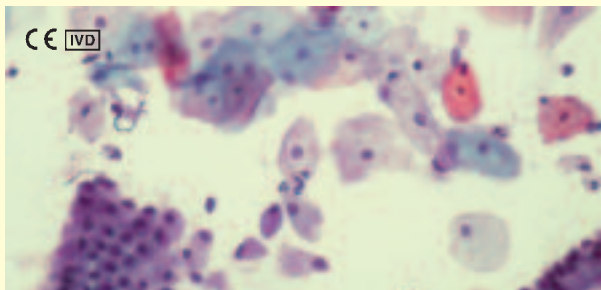

- Polychromatic cytoplasmic stain.
- Clearly differentiates cellular components with pink, green, and blue-green hues.

Description	Pkg/Qty	Order Number
Shandon EA-50	4L x 1	6766002
Shandon EA-50	1L x 2	6766001

Shandon EA-65

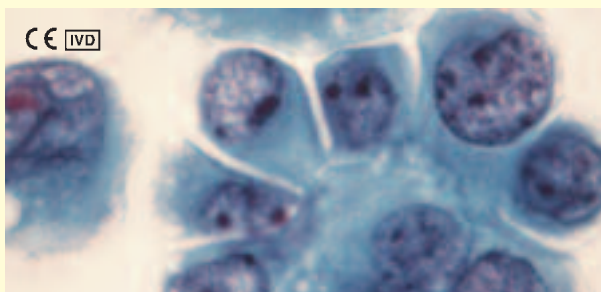

- Polychromatic cytoplasmic stain.
- Lower concentration of Light Green improves expression of eosin-stained components.
- Ideal for thicker non-GYN preparations.

Description	Pkg/Qty	Order Number
Shandon EA-65	4L x 1	6766004
Shandon EA-65	1L x 2	6766003

Shandon Cytology Spatula



- Economical.
- Designed with classic Ayre end and tapered tip.
- Made from smooth, select wood for good cell retention and release.

Description	Pkg/Qty	Order Number
Shandon Cytology Spatula	1000 (40 Bags x 25)	9990330

Shandon OG-6

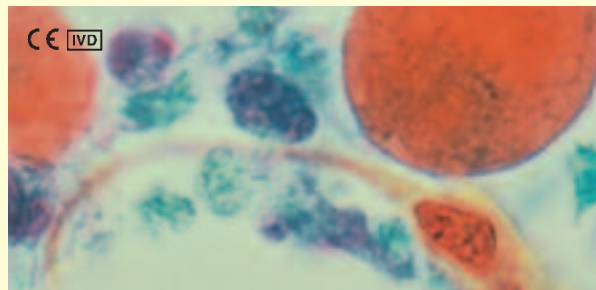

- Demonstrates keratin in cytoplasm.

Description	Pkg/Qty	Order Number
Shandon OG-6	4 L x 1	6766006
Shandon OG-6	1 L x 2	6766005

Shandon Kwik-Diff™ Stains*

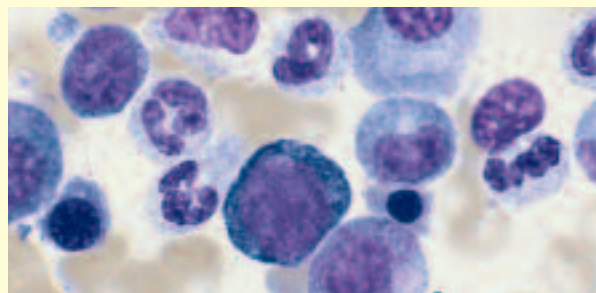

- Fast 3-step differential stain for cytologic preparations, FNAs and microorganisms such as Helicobacter pylori.
- A quick alternative to traditional Wright's and Giemsa Staining procedures.
- Kit Components: Reagent 1: Fixative
Reagent 2: Eosin
Reagent 3: Methylene Blue
- Available in kit form or as individual components.

Description	Pkg/Qty	Order Number
Shandon Kwik-Diff Stain Kit	500ml Reagent Size	9990700
Shandon Kwik-Diff Stain Kit	125ml Reagent Size	9990701
Shandon Kwik-Diff Reagent 1	4L x 1	9990705
Fixative		
Shandon Kwik-Diff Reagent 2	4L x 1	9990706
Eosin		
Shandon Kwik-Diff Reagent 3	4L x 1	9990707
Methylene Blue		

*Sold only in the USA.

Thermo Scientific Shandon Cytoblock® Cell Block Preparation System



- Facilitates processing of FNAs, tissue fragments and cell buttons quickly and reliably.
- Increases ability to process scanty or unseen material for cell block and reduces loss of critical material.
- Suitable for immunohistochemical techniques.
- Replaces time-consuming and costly agar and thrombin techniques.
- Requires phosphate-free fixative on processor, such as Zinc Formal-Fixx™, Formal-Fixx™, or Glyo-Fixx™ (formalin substitute) or simply bypass formalin fixation steps on processor. Cytoblock can also be run on a rapid biopsy program.

Description	Pkg/Qty	Order Number
Cytoblock Cell Block Preparation System	1 kit / 50 specimens	7401150
Replacement Reagents	11ml / Each	7401151

Thermo Scientific Shandon Octospot™

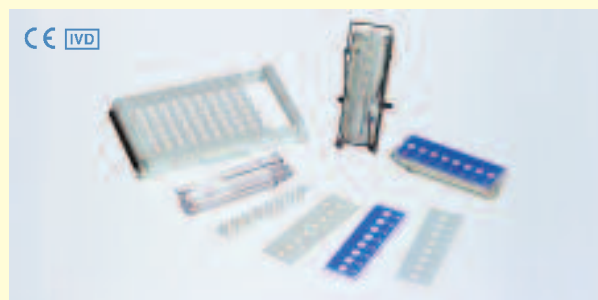

- Cyto-centrifuge cells from 8-well microtiter strips directly onto a microscope slide (96 spots per spin). Turn 8 slides into 1.
- Incorporates an 8-well strip, an 8-well slide, a holding block and filter card assembled in a standard Cytoclip.
- Solvent-resistant slides retain separate reagents in individual wells to prevent cross-contamination.

Description	Pkg/Qty	Order Number
Octospot Starter Pack with Easy Write Slides	Each	1001622
Octospot Starter Pack with Solvent Resistant Slides	Each	1001623
Filter Cards Thick (for protein free samples of 30-40 microliters)	100 / Pk	1001641
Filter Cards Thin (for 15-20 microliter samples)	200 / Pk	1001649
8-well Strips	12 strips/rack x 5	1001643
8-well Strips Loose	60 / Bag	1001642
Solvent-Resistant Slides 8 spots	100 / Box	1001645
EZ-Write Slides 8 spots	100 / Box	1001646
Coverglass 22 x 70mm, 1.0 thickness	1oz. Pk x 10 / Cs.	1001624
Holding Block	Each	1001644
Slide Rack Lids	50 / Pk	1001647

©2008 Thermo Fisher Scientific Inc. All rights reserved. Octospot is a trademark of Bath Analytical. All trademarks are the property of Thermo Fisher Scientific and its subsidiaries.

Anatomical Pathology

Richard-Allan Scientific
Subsidiary of Thermo Fisher Scientific
4481 Campus Drive
Kalamazoo, MI 49008
1-800-522-7270
(269) 372-2674 fax

Thermo Shandon Limited
Subsidiary of Thermo Fisher Scientific
93/96 Chadwick Road
Astmoor, Runcorn
Cheshire WA7 1PR
0800 0189396 +44 (0) 1928 562501
+44 (0) 1928 562627 fax

www.thermo.com/pathology