

# **Cryotome<sup>®</sup>**

*STANDARD AND ELECTRONIC*

## **Standard & E**

ENGLISH

Issue 3

## **OPERATOR GUIDE**

## **77210163**

**Thermo**  
S C I E N T I F I C

# SYMBOLS

The following symbols and conventions are used throughout this manual and on the instrument.



**THIS SYMBOL IS USED ON THE EQUIPMENT, OR IN A DOCUMENT, TO WARN THAT INSTRUCTIONS MUST BE FOLLOWED FOR SAFE AND CORRECT OPERATION. IF THIS SYMBOL APPEARS ON THE INSTRUMENT, ALWAYS REFER TO THIS OPERATOR GUIDE.**



**THIS SYMBOL IS USED ON THE EQUIPMENT, OR IN A DOCUMENT, TO WARN THAT A HAZARD MAY EXIST DUE TO AN EXTREME OF TEMPERATURE. IF THIS SYMBOL APPEARS ON THE INSTRUMENT, ALWAYS REFER TO THIS OPERATOR GUIDE.**



**THIS SYMBOL IS USED ON THE EQUIPMENT, OR IN A DOCUMENT, TO WARN THAT THERE MAY BE A BIOHAZARD ASSOCIATED WITH THE INSTRUMENT. ALWAYS ACT WITH COMMON SENSE AND BE AWARE OF THE SAMPLES USED. TAKE SUITABLE PRECAUTIONS**



**THIS SYMBOL IS USED ON THE EQUIPMENT, OR IN A DOCUMENT, TO WARN THAT HARMFUL CHEMICALS ARE USED WITH THE INSTRUMENT. REFER TO THE MATERIAL SAFETY DATA SHEETS FOR THE CHEMICALS USED. ALWAYS ACT WITH COMMON SENSE AND BE AWARE OF LOCAL LABORATORY PROCEDURES. TAKE SUITABLE PRECAUTIONS**



**A warning is given in the document if there is a danger of personal injury or damage to samples or equipment**

## Note

- Notes give more information about a job or instruction but do not form part of the instruction*



**The Cryotome range meets the following CE Mark requirements:**

In Vitro Diagnostic Directive 98/79/EC

Low Voltage Directive 73/23/EEC, as amended by 93/68/EEC.



Thermo Fisher Scientific makes every endeavour to ensure that the information contained in its support documentation is correct and clearly stated but does not accept responsibility for any errors or omissions. The development of Thermo products and services is continuous. Make sure that any published information that you use for reference is up to date and relates to the status of the product. If necessary, check with Thermo or your local Thermo representative.

© 2009 Thermo Fisher Scientific. All rights reserved.

This manual may not, in whole or in part, be copied, photocopied, reproduced, translated, or converted to any electronic or machine readable form without prior written consent of Thermo

# LIST OF CONTENTS

CONTENTS	This Page
<b>WELCOME</b> Introduction; Safety	4
<b>DESCRIPTION</b> Overview	7
<b>CONTROLS</b> Description; Main Control Panel; Connections;	8
<b>INSTALLATION AND SETTING UP</b> Introduction; To Unpack; To Set Up the Cryotome; Electrical Requirements;	21
<b>OPERATION</b> Description, Safety Considerations, Precautions.	40
<b>CLEANING AND MAINTENANCE</b> Introduction; Routine Cleaning and Maintenance Instructions	47
<b>TROUBLE SHOOTING</b> Introduction; Instrument Function; Sectioning Problem Solutions	53
<b>SPECIFICATION AND ACCESSORIES</b>	57
<b>WARRANTY STATEMENT</b> Warranty Statement; Declaration of Conformity	60
<b>INDEX</b>	62
<b>APPENDIX A - TRANSPORTATION INSTRUCTIONS</b> To Repackage the Instrument; Product Return Safety Declaration	65
<b>APPENDIX B - APPROVED REAGENT LIST</b>	69
<b>APPENDIX C - EXAMPLES</b>	70

Thermo Shandon Limited is an ISO 9001 and TickIT Accredited Company  
*Cryotome*, *Cryomatrix*™ and *Cryochrome*™ are trade marks of Thermo Shandon Limited  
Thermo Fisher Scientific is the trading name of Thermo Shandon Limited

All information contained in this manual is proprietary and confidential, and the exclusive property of Thermo Fisher Scientific. This manual is protected by copyright and any reproduction is prohibited. This manual is for use only by the individuals to which it has been made available by Thermo Fisher Scientific.

# WELCOME

## 1 INTRODUCTION

Welcome to the Cryotome Electronic (E) and standard cryostats. The Cryotome series of cryostats is designed for the routine sectioning of quick-frozen tissue specimens embedded in a medium, for subsequent preparation and diagnosis by a pathologist. The Cryotome series of cryostats are intended for use in Pathology Laboratories by appropriately trained Medical Laboratory Technicians.

Designed and made with care, the instrument is safe to use, simple to operate, and easy to maintain. The Cryotome series of cryostats conforms with IEC1010-1 the safety standard for laboratory instruments.

This Operator Guide gives instructions for the correct operation and use of the Cryotome E and Cryotome. Instructions and information that applies only to a particular version of Cryotome are marked [*E only*] for Electronic Cryotomes, or [*Std only*] for Standard Cryotomes.

## 2 SAFETY



**THIS PARAGRAPH DETAILS IMPORTANT SAFETY INFORMATION. PLEASE READ THIS SECTION CAREFULLY.**

Thermo products are designed for convenient and reliable operation and to accepted standards of safety. The use of the Cryotome does not entail any hazard if operated in accordance with the instructions given in this manual. However, incorrect actions by a user may damage the equipment, or cause a hazard to health. It is important for you to obey the following safety precautions:

- i All users must read and understand the Operator Guide and only operate the unit in accordance with the instructions. If the instructions are not followed, then the protection provided by the instrument may be impaired.**
- ii Do not modify the instrument - if unauthorised modifications are carried out, the instrument may be made unsafe and the warranty may be invalidated.**
- iii Potentially lethal voltages above 110V a.c. or 50V d.c. are present inside the instrument.**

- iv This instrument has a protective earth system and must be properly connected to a good earth (Ground) via the mains input supply.
- v Do not remove any panels or covers unless specifically instructed to do so. Cryotome does not have any user serviceable parts inside the instrument.
- vi It is important that normal standards of safety and good laboratory practices are employed. Always use common sense and the best known practice when operating the instrument.
- vii Sharp knives and blades are used in this instrument. Make sure you understand the correct methods for their fixing and use.
- viii The Centre of Gravity position for the Cryotome is shown below:

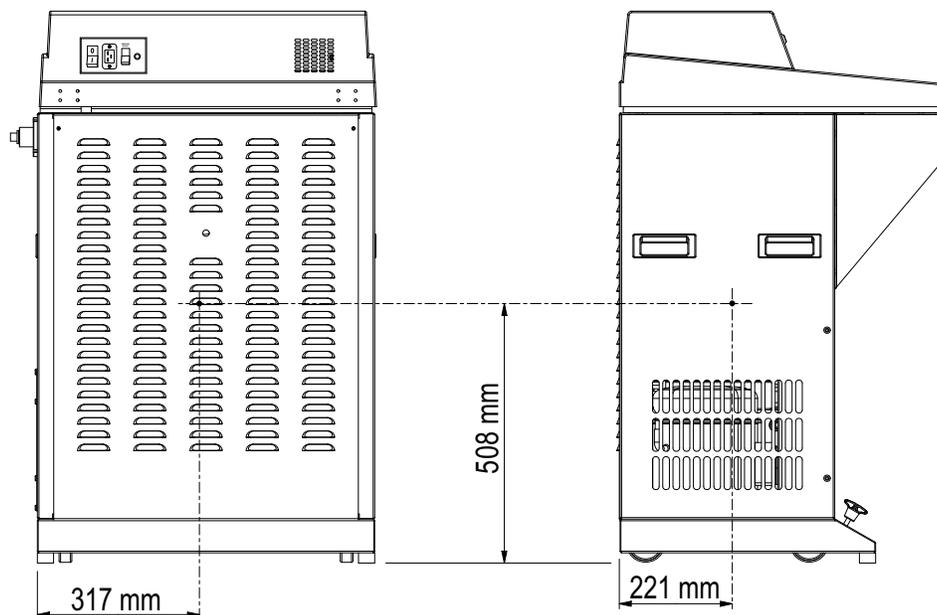

- ix The Cryotome weighs approximately 120 kilograms (265 lbs) when empty; get help to move it.
- x If the instrument has been used with materials that are toxic or contaminated with pathogenic micro-organisms, follow your laboratory guidelines and the fumigation and cleaning instructions given in Chapter 5 of this Operator Guide. The Product Return Certificate (in Appendix A) must be completed if the instrument is to be returned to Thermo or serviced by a Thermo trained engineer.

- xi The instrument should be regularly cleaned as described in Chapter 5 of this Operator Guide. Refer to Material Safety Data Sheets when dealing with the reagents specified in Appendix B.**
  
- xii Do not use the Cryotome for general refrigeration purposes, such as storage of specimens. Use a conventional freezer.**
  
- xiii Use only Thermo approved accessories or replacement parts with the Cryotome.**
  
- xiv Correct maintenance procedures are essential to maintain safe operation and for consistent performance. It is recommended that a Maintenance Contract is taken out with your supplier.**
  
- xv The instrument must be serviced annually by a Thermo trained engineer in accordance with the instructions contained in the Cryotome Service Manual (77210166).**
  
- xvi Any problems and queries should be referred to your supplier.**

#### **xvii Refrigeration System**

**The Cryotome uses R404A refrigerant**



**THE REFRIGERATION SYSTEM MUST ONLY BE WORKED ON BY SUITABLY QUALIFIED ENGINEERS**



**REFRIGERANTS ARE GREENHOUSE GASSES AND ALL PRECAUTIONS MUST BE TAKEN TO RECOVER ANY GAS REMOVED FROM UNITS AND TO PREVENT ITS RELEASE INTO THE ATMOSPHERE**



**ALWAYS USE THE CORRECT REFRIGERANT TO CHARGE THE INSTRUMENT AND ALWAYS DISPOSE OF ANY USED REFRIGERANT IN ACCORDANCE WITH LOCAL AND NATIONAL REGULATIONS**

# DESCRIPTION

## 1.1 CRYOTOME OVERVIEW

The Cryotome is designed for cutting frozen sections of fixed and unfixed specimens, rapidly and accurately, for future examination by microscope. It operates by rapidly freezing the sample in a temperature controlled environment, and provides means for sectioning the frozen sample by conventional microtome.

The different components of the Cryotome are shown in the diagram.

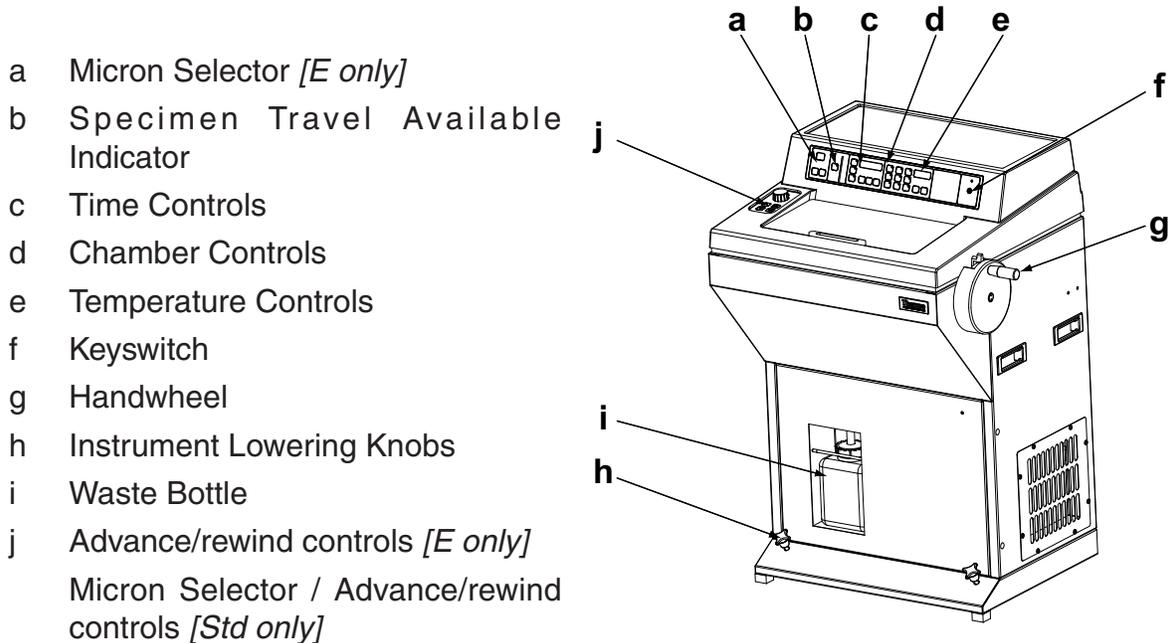

For optimum performance, the microtome Specimen Head and Knife Holder are held within the refrigerated chamber. The main body of the microtome is mounted outside the chamber to give more space for working in, and for easier cleaning.

Principal factors for good sectioning of frozen specimens are:

- i the temperature must be correct for the specimen being cut.
- ii the microtome must be correctly adjusted and operated.
- iii the cutting blade must be sharp and set at the correct angle.
- iv the anti-roll plate must be correctly adjusted.

# CONTROLS

## 2.1 DESCRIPTION

This chapter describes the displays and the functions of all the controls on the instrument.

## 2.2 MAIN CONTROL PANEL

The Main Control Panel is situated on the front of the instrument (a). Operation of the buttons is confirmed by an audible tone, a change in the display, or by an integral pushbutton indicator. Display panels show instrument status and error messages.

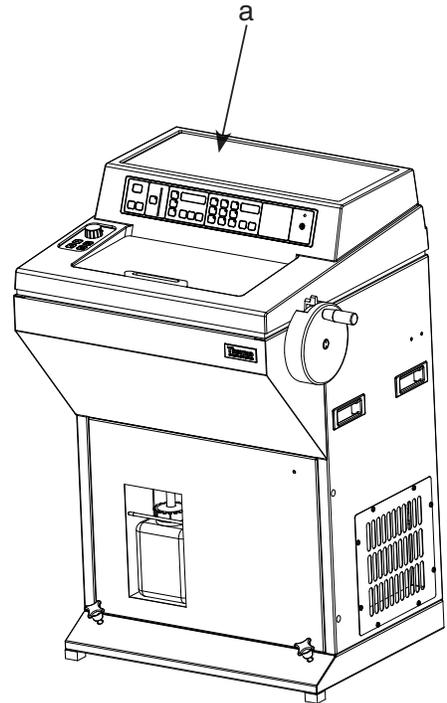

### Note

1 There is no 'feel' when a switch operates.

The Main Control Panel is divided into five sections.

### 2.2.1 MICRON SELECTOR [E only]

The Micron Selector section of the Control Panel displays the thickness in microns of the sections being taken.

The number in the display is changed by pressing the [+] and [-] buttons. Press [+] to increase the thickness by 1 (if the number is in the range 0 - 19), or 5 (if the number is in the range 20 - 55). Press [-] to decrease the thickness by the same amounts.

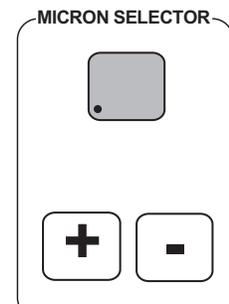

### Note

1 A dot in the left hand side of the display (i) indicates that the Specimen Head is moving in the REWIND direction. A dot to the left of the right hand digit in the display (ii) indicates that the Specimen Head is moving in the ADVANCE direction.



2 The Micron Selector on the Standard Cryotome is a rotary knob which changes the thickness in  $1\mu\text{m}$  steps between 1 and  $30\mu\text{m}$  (see section 2.3.1)

## 2.2.2 SPECIMEN TRAVEL

The vertical bar graph contains separate segments that light up sequentially as the Specimen Head advances from its maximum available travel position. The proportion of lit to unlit segments indicates the amount of travel still available at any time.

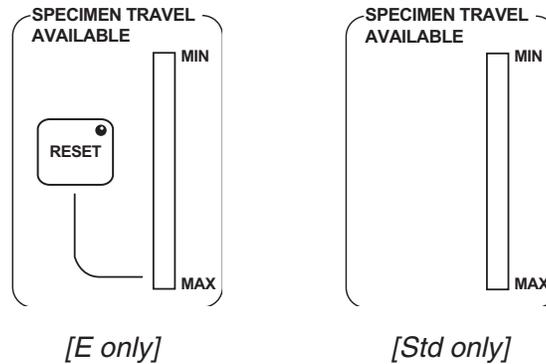

When the instrument is first powered up, the first segment flashes to indicate that the Specimen Head is in its maximum available travel (MAX) position. As the Specimen Head advances at the end of each cutting stroke, the segments of the display light one by one until eventually all the segments are lit when no more travel is available. An audible alarm operates when the end of travel is reached.

*[E only]:*

Press **[RESET]** to return the Specimen Head to its maximum available travel position. The button LED will light and the display will flash during the reset and the segments will count down until the Specimen Head reaches maximum travel. The first segment will flash.

### Note

- 1 When the instrument is being reset, all other advance or rewind functions are over-ridden. This occurs each time the instrument is switched on, or **[RESET]** is pressed.

## 2.2.3 TIME CONTROLS

The Time Controls allow you to set the clock time, defrost times and fumigate times. Real time is displayed in 24 hour clock format, and a flashing colon (:) shows that operation is normal.

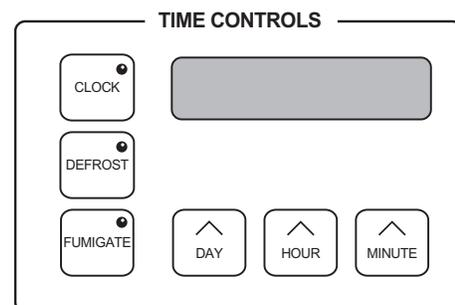

### 2.2.3.1 TO SET THE CLOCK

Press and hold [**CLOCK**] and then press the relevant button detailed below. Release the buttons when the correct information is displayed.

To Set the...	Press and hold [ <b>CLOCK</b> ] then press:	Display will show:
Day	[ <b>DAY</b> ]	1 - 7 <b>Note</b> <i>Keep Monday as Day 1 to avoid confusion</i>
Hours	[ <b>HOURS</b> ]	0 - 23
Minutes	[ <b>MINUTES</b> ]	1 - 59

### 2.2.3.2 TO SET DEFROST TIMES

Press and hold [**DEFROST**] and then press the relevant button detailed below. Release the buttons when the correct information is displayed.

To Set the...	Press and hold [ <b>DEFROST</b> ] then press:	Display will show:
Day	[ <b>DAY</b> ]	0 - 9 ( <i>see note 1 below</i> )
Hours	[ <b>HOURS</b> ]	0 - 23
Minutes	[ <b>MINUTES</b> ]	1 - 59

**Note:**

1 Use the following settings for the days:

- DAY 0* = prevents the programmed function.
- DAY 1-7* = defrosting starts at the time set on the day shown (set Monday as Day 1 to avoid confusion).
- DAY 8* = defrosting starts at the set time every day
- DAY 9* = **STANDBY (PSAVE = power save)**

2 Standby (**PSAVE**) allows the instrument to remain switched on in a defrosted state for up to 24 hours until a pre-determined time. It then returns to its normal operational state

**To set Standby (PSAVE) mode**, press and hold [**DEFROST**] then press [**DAY**] and select day 9. Set the time that normal operation is required to resume. Release the buttons.

**To start (PSAVE) mode immediately**, press **[IMMED DEFROST]**. The instrument then runs its defrost cycle for 15 mins and goes to (PSAVE) on completion. Use **[CANCEL DEFROST/ FUMIGATE]** to end the function before the cycle is complete.

**Note:**

- 1 It can take 1 - 2 hours after (PSAVE) mode to cool the Refrigerated Chamber sufficiently for use. Make allowance for this when setting the resume time.

### 2.2.3.3 TO SET FUMIGATE TIMES

Follow the instructions in 2.2.3.2 (To Set Defrost Times), but press **[FUMIGATE]** instead of **[DEFROST]**.

**To start (PSAVE) mode**, press **[IMMED FUMIGATE]**. The instrument then starts the 5 hour Fumigate cycle before going into (PSAVE).

## 2.2.4 CHAMBER CONTROLS

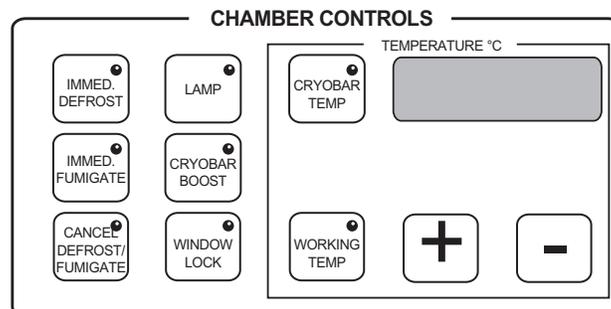

### 2.2.4.1 [IMMED DEFROST]

Press **[IMMED DEFROST]** to defrost the refrigeration system. In addition:

- i the compressor switches on,
- ii Cryobar Boost is switched off,
- iii **[IMMED DEFROST]** is lit,
- iv **dEF** shows in the temperature display.
- v After 5 minutes the defrost heater and compressor switch off for a further 10 minutes.

Defrosting stops after 15 minutes and the instrument reverts to its previous state. Press **[CANCEL DEFROST/FUMIGATE]** to stop the defrosting process earlier if required.

**Note**

- 1 *The compressor will not restart until 3 minutes after it stopped*
- 2 *Defrosting cannot take place if the Chamber or Cryobar temperature is above 0°C*
- 3 *If the Day 9 option is selected when setting the defrost times, then the instrument will enter STANDBY (PSAVE) mode when defrosting finishes.*

**2.2.4.2 [IMMED FUMIGATE]**



**TAKE CARE WHEN FUMIGATION IS IN PROGRESS. BE AWARE OF THE HAZARDS POSED BY FORMALIN AND ACT ACCORDINGLY. REFER TO MATERIAL SAFETY DATA SHEET (MSDS) FOR FORMALIN**

**Note**

- 1 *The window **MUST** be shut and locked before fumigation can start. If **[IMMED FUMIGATE]** is pressed when the window is not shut, Err 4 is displayed and the fumigate cycle is aborted.*
- 2 *Fumigation can only be cancelled by **[CANCEL DEFROST/FUMIGATE]** during stages iii and iv that follow. Stage v and vi cannot be cancelled.*

Press **[IMMED FUMIGATE]** to initiate the following sequence:

- i the **[IMMED FUMIGATE]** button LED lights and the display shows Ald (Formaldehyde).
- ii the window lock is activated if the window has not already been locked by manual use of the **[WINDOW LOCK]** push-button.
- iii a 5 minute defrost is started, then....
- iv the compressor is switched off and a one hour chamber defrost starts,
- v the Formalin trough is heated to 100°C for 45 minutes
- vi the heater is switched off and fumigation takes place over four hours.

- vii the instrument reverts to its previous setting when the fumigate cycle is finished.

#### **Note**

- 1 *If the Day 9 option is selected when the fumigation time is set, then the instrument enters Standby (PSAVE) mode when fumigation finishes.*

#### **2.2.4.3 [CANCEL DEFROST/FUMIGATE]**

Press **[CANCEL DEFROST/FUMIGATE]** to terminate a Defrost or Fumigate sequence. The button LED remains lit until the process has finished.

#### **2.2.4.4 [LAMP]**

Press **[LAMP]** to switch on the fluorescent lamp to illuminate the work area. The button LED is lit when the light is on. The next press switches off the lamp and indicator.

#### **2.2.4.5 [CRYOBAR BOOST]**

Press **[CRYOBAR BOOST]** to turn on the peltier element in the Cryobar for 10 minutes. The compressor is also switched on for this period. *(However, if the compressor switched off within the last three minutes, there is a delay of up to three minutes before the compressor re-starts.)*

If **[CRYOBAR BOOST]** is pressed while its LED is flashing at the end of the boost period, the boost is repeated for a further 10 minutes, otherwise normal operation follows when a boost period times out.

#### **Note**

- 1 *The Cryobar is situated on the refrigeration pipework and its temperature can vary considerably. Do not use the Cryobar for storing specimens.*

#### **2.2.4.6 [WINDOW LOCK]**

**[WINDOW LOCK]** locks the window in the closed position. The window must be fully closed before the lock can operate. A second press releases the lock. If the window is not properly closed when the button is pressed, **Err 4** is displayed. The lock remains in the locked state during power off (if already locked).

## 2.2.5 TEMPERATURE CONTROLS

To set the working temperature, the appropriate button must be pressed with **[+]** and **[-]** to raise or lower the value of the number in the display. Press and hold until the desired temperature is displayed, then release both buttons. The display then reverts to showing the actual temperature in °C.

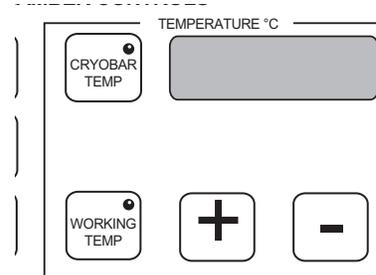

### Note

- 1 *It is not possible to set the temperature of the Cryobar. The Cryobar is situated on the refrigeration pipework and its temperature can vary considerably.*
- 2 *To monitor the temperature, press and release **[CRYOBAR TEMP]** or **[WORKING TEMP]** as appropriate. The display will show the actual temperature of that component in °C. A lit LED shows which selection is displayed.*

Working temperatures are automatically controlled to within 1°C of the set temperature. If no temperature is set, or after a reset, the working temperature automatically defaults to -20°C, or the last programmed temperature.

**[CRYOBAR TEMP]** displays the surface temperature of the Cryobar. However, if **[CRYOBAR BOOST]** is lit on the adjacent panel, the display shows the approximate surface temperature of the peltier element in the Cryobar.

## 2.2.6 KEYSWITCH CONTROL

The Control Panel can be locked from the two-position keyswitch. The Control Panel is disabled when the key is vertical (off) and the LOCKED indicator is lit. The key is removable when vertical.

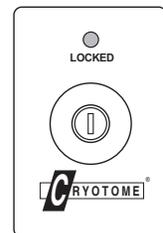

To unlock the Control Panel, insert the key and turn it clockwise. The LOCKED indicator is not lit when the Control Panel is unlocked, and the key is held in the switch.

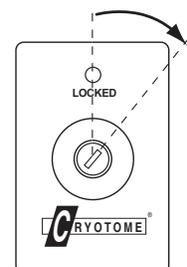

## 2.3 ADVANCE CONTROL PANEL

The Advance Control Panel is the horizontal panel located to the left of the window.

### 2.3.1 Standard Cryotome only

The Advance Control Panel on the standard Cryotome contains two rotary control knobs.

The small knob (*a*) is the Micron Selector. This sets the section thickness - the distance that the Specimen Head advances after each cutting stroke. The range is 0 - 30 $\mu$ m in increments of 1 $\mu$ m.

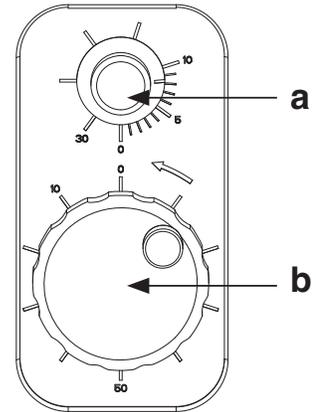

The larger knob (*b*) is the Rewind/Advance Control. Use this for coarse adjustment of the Specimen Head position and also to retract the Specimen Head to the Maximum Travel Available position.

Turn the Rewind/Advance Control knob clockwise to rewind the head and anti-clockwise to advance the head. One rotation of the knob equates to a movement of 100 $\mu$ m at the Specimen Head.

### 2.3.2 Cryotome E only

The Advance Control Panel on the Cryotome E contains the following buttons that control movement of the Specimen Head;

-  - REWIND
-  - ADVANCE
-  - FAST REWIND
-  - FAST ADVANCE

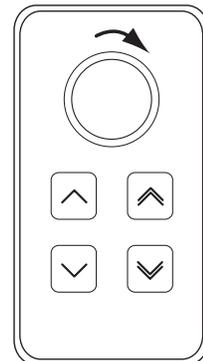

There is also a notched Electronic Rotary Control that advances or retracts the Specimen Head 8 microns per notch dependent on the direction of rotation - clockwise to advance; counter clockwise to retract.

## 2.4 MESSAGE CODES

The following displays show in the Temperature display when conditions are appropriate.

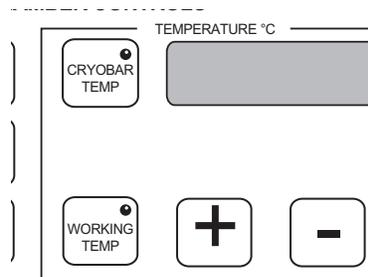

- i **Ald** shows when fumigation is in progress.
- ii **LOBAT** signifies that the internal back-up battery is not charged sufficiently to retain information during an interruption of the mains supply.

The battery retains programmed information in memory while the power is switched off. Stored information is lost if it is allowed to discharge.

Power must be on to recharge the battery. If **LOBAT** still shows after power is restored for more than 12 hours, contact your Thermo dealer for service.

- iii **dEF** shows when defrosting is in progress.
- iv --- shows if the associated temperature probe is faulty.
- v Fault Codes show in the Temperature display if the instrument malfunctions. Press **[WORKING TEMP]** or **[CRYOBAR TEMP]** to over-ride most faults. Faults F:11, F:12 and F:13, cause the instrument to wait for 30 mins then reset and attempt to reach its default temperature of -20°C.

### Note

1 *If the fault fails to clear, contact your Thermo Dealer for service.*

Indications that show in the Time Controls display are as follows:

- i **P FAIL** (flashing) shows after a normal switch OFF then ON, or if power failed and recovered. The Temperature display shows the temperature of the Refrigerated Chamber at the time power was restored (i.e. the warmest temperature).

Press [**CLOCK**] to clear.

- ii **rESEt** (flashing) shows if a problem caused the instrument to reset and clear its memory to its default status. The number in Temperature display is the temperature of the Refrigerated Chamber at the time normal operation resumed.

Press [**CLOCK**] to clear.

- iii **P SAVE** shows until the programmed time if the instrument is in Standby (PSAVE) mode following the selection of a DAY 9 Defrost or Fumigate function.

Press [**CANCEL DEFROST/FUMIGATE**] to override.

- iv **Err 1** denotes an invalid push-button entry, or if too many push-buttons are pressed simultaneously.

Press [**CLOCK**] to clear.

- v **Err 2** denotes an invalid push-button entry during Defrost/Fumigate, or if Defrost is inhibited because the Cryobar and Refrigerated Chamber are too warm

Press [**CLOCK**] to clear.

- vi **Err 4** denotes a window lock error (not locking or unlocking).

Press [**CLOCK**] to clear.

## Note

- 1 *Err 3 is not used on these versions of Cryotome.*

## 2.5 CONNECTIONS

The connections to the electronics box are shown below:

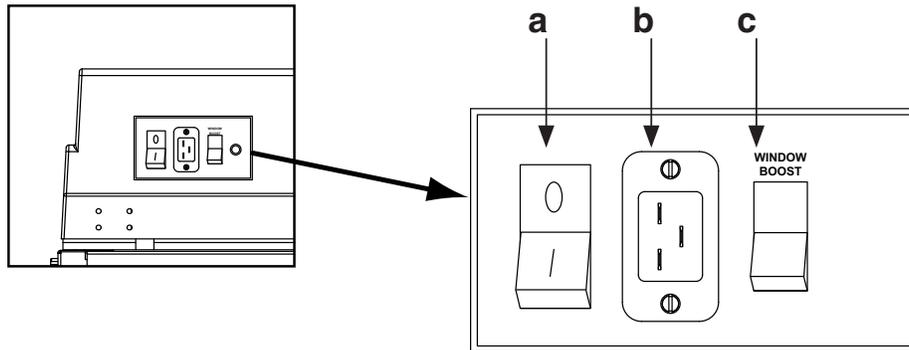

### **a Mains On/Off Circuit Breaker**

This is the main power switch of the instrument. Its use is fully described in section 3.5.

### **b Power Inlet**

The mains power inlet. It is fully described in section 3.4.

### **c Window Boost**

Press the Window Boost switch to provide extra de-misting power in conditions of high humidity. Its use is described in section 5.4.

# INSTALLATION AND SETTING UP

## 3.1 INTRODUCTION

The Cryotome is a precision instrument that must be unpacked and installed with care.

The maximum overall dimensions of the Cryotome cryostat are:

Width	660 mm	(26 ins)
Depth	640 mm	(25¼ ins)
Height	1070 mm	(42¼ ins)



**THE CRYOTOME WEIGHS APPROXIMATELY 120kg (265lbs). ALWAYS GET HELP TO SAFELY MOVE THE INSTRUMENT WITHOUT RISK OF INJURY**

## 3.2 TO UNPACK

If the packaging has been damaged, check the condition of the instrument. Contact your dealer if there is any damage.

Check that the detail on the label of the crate corresponds with the Purchase Order, and that the power supply capability of your local socket outlet is compatible with the power demand of the Cryotome.

Move the crate near to where the instrument is to be sited. Cut the retaining straps then lift the outer case vertically. Read the label on the rear of the instrument and check that it conforms with your order.

Retrieve the accessories pack from on top of the pallet in front of the instrument, then lift the Cryotome off the Pallet. Make sure that you have received all the parts listed on the packing list supplied with the instrument. Contact your dealer if necessary

### Notes

- 1 *Inform your dealer immediately if there are any breakages or shortages. Quote the instrument Serial Number, your Order Number, Invoice Number, Delivery Note (or Packing Slip) Number and the date.*

- 2 *If you ever need to transport the instrument, refer to Appendix A for repacking instructions.*

**WARNING** Always keep the instrument vertical to prevent damage to the refrigeration system.

**WARNING** Consult your Thermo dealer if the Cryotome is to be moved to another building, or out of the area. Transit fixings must be re-fitted. The instrument must be kept upright at all times.



**THE CRYOTOME WEIGHS APPROXIMATELY 120kg (265lbs). ALWAYS GET HELP TO SAFELY MOVE OR LIFT THE INSTRUMENT WITHOUT RISK OF INJURY**

To move the Cryotome, turn the lowering knobs clockwise until the two front feet of the instrument are on the floor. Push the instrument. Alternatively, two people can lift the instrument using the hand-holds on either side of the instrument.

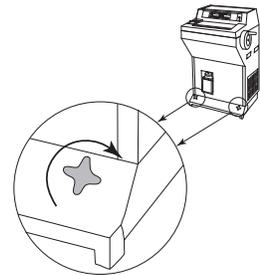

**THE INSTRUMENT IS HEAVY. ALWAYS MAKE SURE THE ROUTE IS CLEAR WHEN MOVING THE INSTRUMENT TO AVOID COLLISIONS**

### 3.3 TO REMOVE THE TRANSIT FIXINGS



**TRANSIT FIXINGS ARE ATTACHED TO VARIOUS INTERNAL STRUCTURES TO PROTECT THE INSTRUMENT DURING TRANSPORT. IT IS ESSENTIAL THAT THESE ARE ALL REMOVED BEFORE AN ATTEMPT IS MADE TO OPERATE THE INSTRUMENT**

#### Note

- 1 *The transit fixings that are to be removed are painted red.*
- 2 *Store all the transit fixings for future use when transporting the Cryotome.*

The rear panel must be removed to reach the transit fixings.

To remove the rear panel, undo and remove the bolt from the centre of the rear panel. Undo the 8 screws that secure the rear panel, then carefully pivot the panel around its left hand side (as seen from the rear of the instrument). Lean the panel against the left hand side panel.



**DO NOT DISTURB THE EARTH WIRE THAT IS CONNECTED TO THE REAR PANEL**

### Refrigeration Transit Fixings:

Undo and remove the two red handles (*a*) from the centre of the compressor mounting plate between the fan (*b*) and the compressor (*c*).

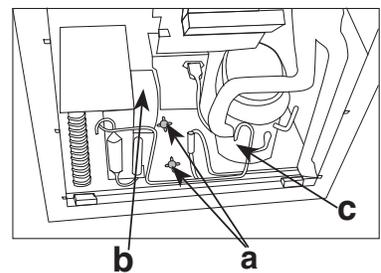
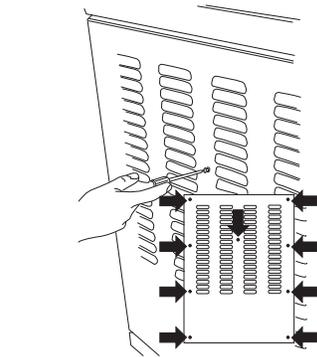

Remove the two wood supports (*d*), coloured red, from under the compressor mounting plate.

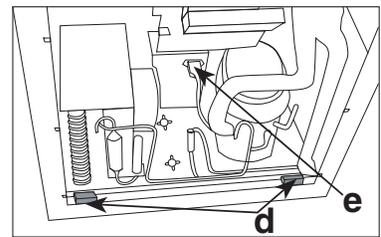

Make sure that the power lead from the compressor to the junction box (*e*) is securely fitted.

Firmly hold the blue plastic coil of the defrost valve on the transit plate at the back of the microtome, then cut the ties that hold the valve (*f*).

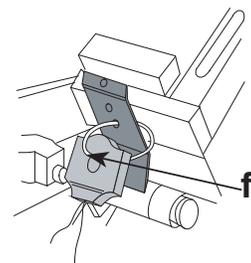

With the coil of the defrost valve still connected to the white wires, place the coil over the tube that projects upward from the copper tube on top of the compressor cooling matrix (*g*). Unpack the blue plastic components and fit the nameplate, the washer, and then the nut to hold the coil of the defrost valve in position. Fit the plastic plug in the hole in the centre of the rear panel.

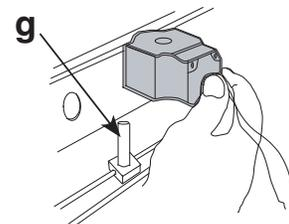

### Microtome Transit Fixings: [E only]

From the underside, support the stud of the clamping bracket that prevents damage to the microtome leadscrew, then undo and remove the top nut (*h*). Support the stud from underneath while allowing it to fall clear of the leadscrew arm.

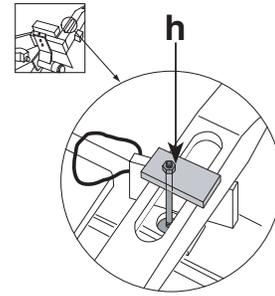

Support the leadscrew arm and use the nylon loop (*i*) to remove the spacer from between the arm of the leadscrew and the casting of the microtome.

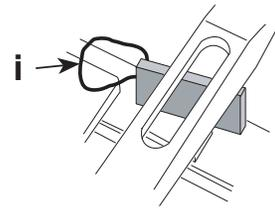

Check that the detection flag at the end of the arm is in line with the slots in the two black plastic opto units of the printed circuit board (*j*). This signifies that the leadscrew and trunnion nut are located correctly.

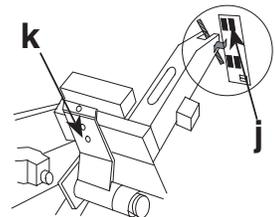

### Note

- 1 Turn the leadscrew to adjust the setting if necessary.

Undo and remove the transit plate that supported the defrost valve (*k*). Replace the rear panel and 8 screws. Retain the transit plate for future use when moving the Cryotome.

## 3.4 TO INSTALL THE CRYOTOME

Move the instrument to its permanent location. This must be **level** and provide a 300 mm (12") clearance to the sides and rear of the instrument for ventilation.

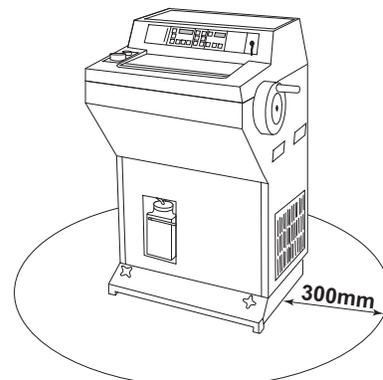

## Note

1 *Inadequate ventilation may have an adverse effect on the cooling system. The recommended ambient temperature is 20°C (68°F); maximum = 35°C (95°F). Performance is adversely affected at ambient temperatures above 30°C (86°F).*

2 *Siting of the instrument on an uneven surface can have an adverse effect on the cooling system. Make sure that the unit is level.*



**THE EFFICIENCY OF THE CHAMBER CAN BE AFFECTED BY DOWNDRAUGHTS. DO NOT SITE THE INSTRUMENT NEAR TO SOURCES OF DOWNDRAUGHTS SUCH AS WINDOWS OR HEATING / VENTILATION DUCTS**

Turn the lowering knobs counter-clockwise until the feet of the instrument are on the floor. The retraction knobs can be unscrewed completely and removed if preferred.

Raise the front edge of the top cover, remove the transit packing from the top of the sliding window, then lower the cover back into position. Push open the sliding window to gain access to the Refrigerated Chamber.

Remove the rubber band and any other packing material from the area around the Cryobar (*h*) on the left hand wall of the Refrigerated Chamber.

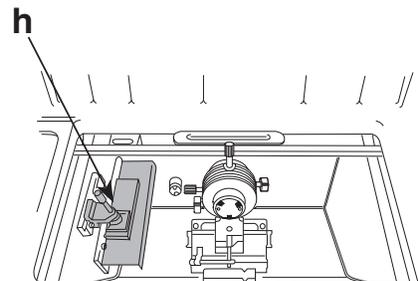
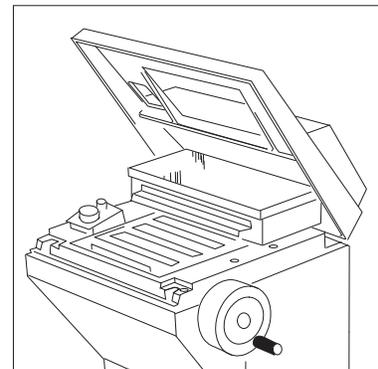
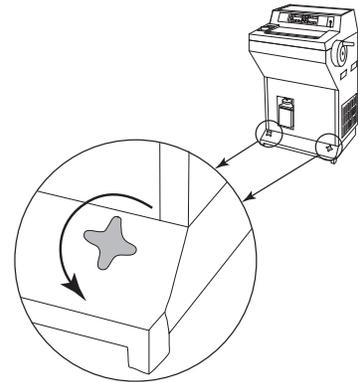

Slide the handwheel carefully onto the drive shaft at the top of the right hand side panel. The handwheel is supplied in the Accessory Pack. Make sure that the locating pin of the handwheel fits into the key-way of the drive shaft.

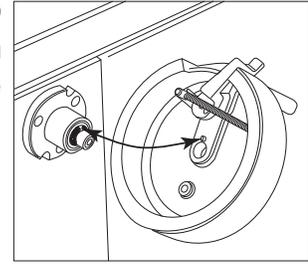

The lever next to the handwheel handle is used to lock the handwheel to prevent inadvertent rotation. To lock the handwheel, push the lever away from you.

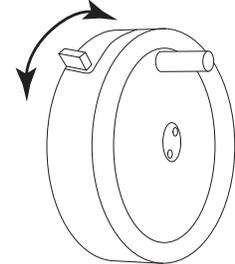

Fit the handwheel bolt then use the special Handwheel Bolt Key to turn the retaining bolt clockwise to tighten. Rotate the handwheel and check that movement is smooth and produces a corresponding movement of the Specimen Head.

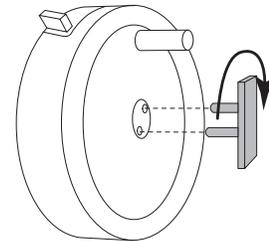

Turn the handwheel until the handle is at the 12 o'clock position then push the lever of the lock away from you. Check that the lock operates and that the handwheel cannot rotate. Check that the Specimen Head is at the top of its travel.

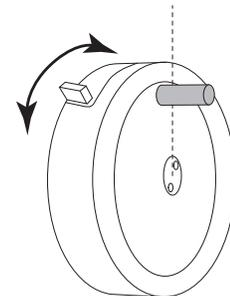

Move the lock lever towards you and check that the handwheel rotates smoothly and produces vertical oscillations of the Specimen Head. Check also that the lock operates at the 'quarter past' and 'half past' the hour clock positions.

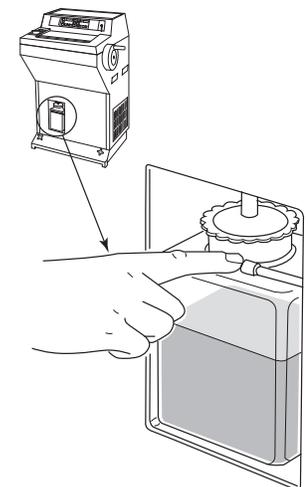

Slide the waste bottle retaining bar to the right, and remove the Waste Bottle. Use a 10% solution of Formalin to fill the Waste Bottle sufficient to cover the outlet tube - approximately 15mm (1/2 inch) deep. The lid of the waste bottle turns counter clockwise to undo.



REFER TO MATERIAL SAFETY DATA SHEET (MSDS) FOR FORMALIN



KEEP SUFFICIENT FORMALIN SOLUTION TO COVER THE END OF THE OUTLET TUBE IN THE WASTE BOTTLE AT ALL TIMES TO PREVENT THE RELEASE OF AEROSOLS OR CONTAMINANTS DURING USE.

### 3.5 ELECTRICAL REQUIREMENTS

Make sure that the voltage of the mains supply corresponds with the voltage rating on the rating plate on the back of the instrument. The mains supply requirements are listed in section 7.1.2 & 7.1.3.

#### Note

- 1 The ~ symbol on the rating plate indicates that the instrument operates on an alternating current supply (a.c.)

Make sure that the I / O power switch at the rear of the instrument is switched off (O side of the switch pushed inward) (a).

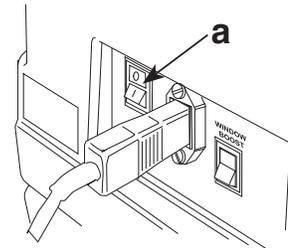

Instruments are supplied with power cords with moulded plugs suitable for many countries. If another plug is required, it is necessary for a technically competent person to remove the moulded plug from the supplied power cord and fit a suitably rated, and where appropriate, fused plug using the wiring convention shown below:

<b>European cable</b>	<b>US cable</b>	<b>Terminal</b>
<i>Brown:</i>	<i>Black</i>	<i>Live (L or L2)</i>
<i>Blue:</i>	<i>White</i>	<i>Neutral (N or L1)</i>
<i>Green / yellow:</i>	<i>Green</i>	<i>Earth - E, ground or <math>\perp</math></i>



**THE CRYOTOME MUST BE PROTECTIVELY EARTHED. MAKE SURE THAT THE INSTRUMENT IS PLUGGED INTO A PROPERLY EARTHED (GROUNDED) MAINS SUPPLY**



**IT MUST BE POSSIBLE TO INTERRUPT THE MAINS SUPPLY AT SOURCE BY REMOVING THE PLUG FROM THE MAINS SUPPLY SOCKET**

Select the appropriate mains lead from those supplied and plug it into the mains inlet socket in the rear panel of the instrument (*b*). Connect the mains supply cable to the local power supply outlet.

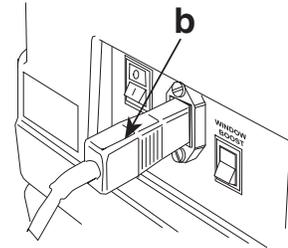

**MAKE SURE THAT BODY OF THE INSTRUMENT IS EFFECTIVELY EARTHED (GROUNDED). A PROPRIETARY GROUND FAULT CIRCUIT INTERRUPTION DEVICE (EARTH LEAK DETECTION) MAY BE FITTED AT THE WALL SOCKET AS AN ADDITIONAL SAFEGUARD**

## 3.5 TO SWITCH ON AND OFF

### 3.5.1 TO SWITCH ON

Press the I (ON) side of the I / O switch inward to switch the instrument on.

Check that the following occur during power on:

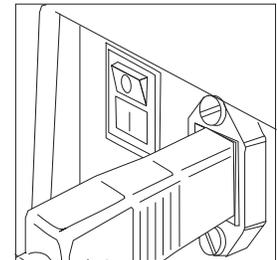

- i ALL lights and indicators of the Control Panel light for three seconds.
- ii *E only*: the Specimen Travel Available bar chart changes to one segment flashing (when the automatic RESET function completes).

*Standard only*: the Specimen Travel Available bar chart remains flashing. Rewind the Specimen Head to give maximum travel available (only one segment flashing). Advance the Specimen Head to stop the single segment flashing and to silence the alarm.

- iii 'P FAIL' shows in the Time Controls display (unless the internal battery is discharged in which case the indication is 'rESEt').

Insert the key in the keyswitch of the Control Panel and turn it clockwise. The LOCKED indicator is not lit when the panel is unlocked and available for use.

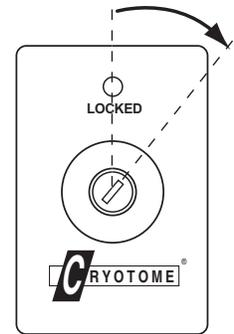

Press [**CLOCK**] to clear the flashing display. The compressor starts operating within three minutes if the desired working temperature set in the Temperature Display is less than the current temperature of the Refrigerated Chamber.

### 3.5.2 TO SWITCH OFF

Press the O (OFF) side of the I / O switch inward to switch the instrument off.

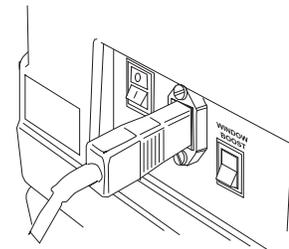

## 3.6 TO PREPARE THE INSTRUMENT FOR USE



Practice good biological safety procedures whenever the Cryotome is used.



Make sure that the Waste Bottle is filled with sufficient 10% Formalin solution to cover the outlet pipe. Refer to the formalin Material Safety Data Sheet



Do not use the Cryotome for general laboratory refrigeration purposes.



Fumigate regularly to ensure decontamination of the Refrigeration Chamber and accessories.



Use mesh gloves when handling knives and blades.

**WARNING** Use the correct type of knife or blade appropriate for the Knife Holder.

**WARNING** Make sure that the knife guard is correctly installed.



If you know that a specific virus or bacteria is likely to be present in the specimen, make sure that you are aware of a suitable decontaminant before you introduce the specimen into the Refrigerated Chamber.



Always make sure that the window is closed before any sections are cut. Aerosols can form when the specimen traverses the knife. These can be hazardous if inhaled.

Setting up the Cryotome for routine operation involves the installation and adjustment of one or more of the following components of the microtome.

- i Knife Holders
- ii Knife Guards
- iii Standard Solid Knife
- iv Cutting Angle
- v Disposable Blades
- vi Disposable Blade cutting angle
- vii Anti Roll Plate angle
- viii Anti-Roll Plate parallelism
- ix Anti-Roll Plate gap
- x Anti Roll Plate height

Both the Standard solid Knife and Disposable Blade Knife Holders fit on a common Carrier attached to the floor of the Refrigerated Chamber.

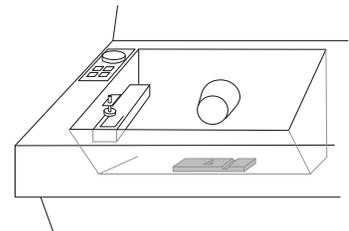

A cam operated screw in the bottom of the knife base engages with a locating slot in the carrier. Pulling the pivoting lever toward you releases the assembly and enables it to be slid forward or backward on the Carrier. The setting determines the distance between the Knife Holder and the Specimen Head of the microtome.

### 3.6.1 TO FIT A KNIFE HOLDER



**ALWAYS LOCK THE HANDWHEEL TO PREVENT IT MOVING WHEN WORKING NEAR THE KNIFE HOLDER**

The Knife Holder is constructed of two parts - a Top and a Base. There are three types of Top to suit the types of knife or blade. The same Base supports all versions of Top.

To fit a Knife Holder on the carrier for disposable blades (*shown in the diagram*), or a standard solid knife, first pull the left hand pivoting lever of the Knife Holder fully toward you.

Engage the sprung dowel at the bottom of the Knife Holder into the circular aperture in the locating slot of the carrier.

Push the bottom of the Knife Holder away from you, then lock in position by pushing the left hand pivoting lever away from you.

Pull the right hand pivoting lever of the Knife Holder fully toward you.

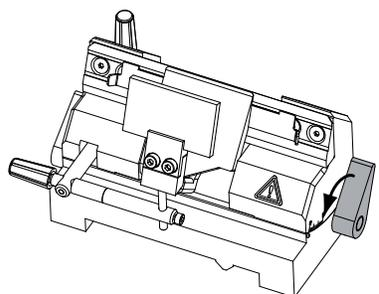
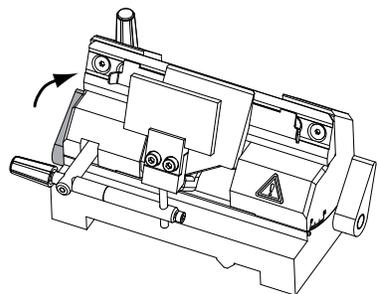
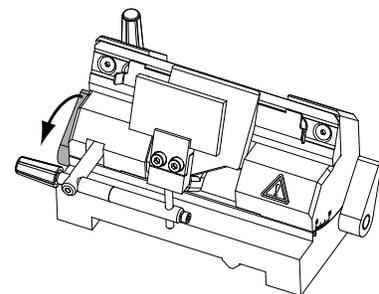
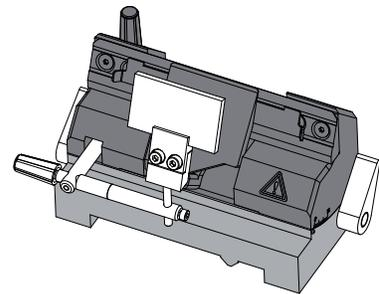

Adjust the angle of the Knife Holder until the '0' of the angle scale is approximately in line with the marker on the knife base, then push the right hand lever away from you to lock.

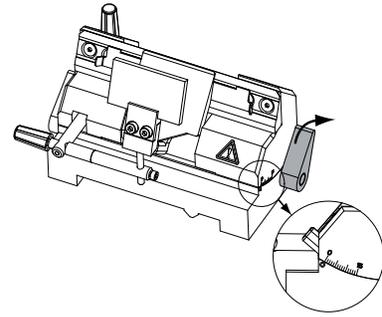

**Note**

- i The Knife Holder is adjusted to its precise operating angle later, after the blade or knife is installed*

**3.6.2 TO FIT A STANDARD SOLID KNIFE**



**THE KNIFE IS SUBSTANTIAL, EXTREMELY SHARP, AND COULD CAUSE SERIOUS INJURY IF MISHANDLED. ALWAYS WEAR MESH GLOVES WHEN HANDLING A KNIFE**



**STORE ALL KNIVES IN THEIR TRANSPORT BOXES WHEN NOT REQUIRED FOR IMMEDIATE USE**



**ALWAYS PLACE THE PLASTIC KNIFE GUARD OVER THE CENTRE OF PORTION OF THE KNIFE WHENEVER THE INSTRUMENT IS NOT BEING USED FOR CUTTING**

**Note**

- 1 The stainless steel knife guard is specifically designed to operate with 160 x 34 x 10mm knife profiles.*

Loosen the two clamp knobs on the standard solid Knife Holder by turning them counter clockwise.

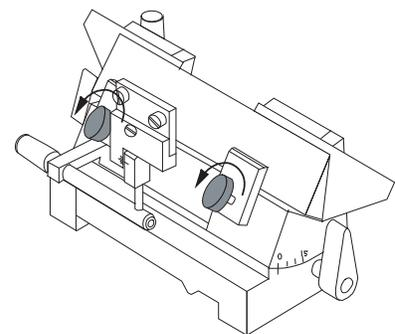

Turn the control bar of the Anti Roll Plate towards you to provide clearance for the knife between the anti roll plate and the knife guard.

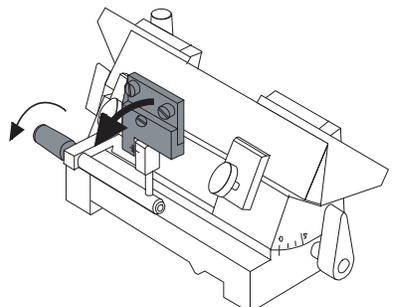

Carefully slide the knife in front of the removable knife guard and place it centrally and squarely in the base of the Knife Holder. Tighten the clamps clockwise to secure the knife in position

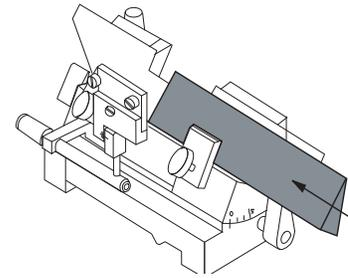

### 3.6.3 TO SET UP THE KNIFE HOLDER AND ANTI-ROLL PLATE FOR STANDARD SOLID KNIVES

#### Note

- 1 *These are the recommended settings. You may need further minor adjustments to obtain best results.*

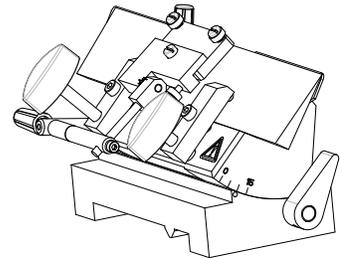

Release the angle clamp by pulling the right hand pivoting lever of the Knife Holder towards you.

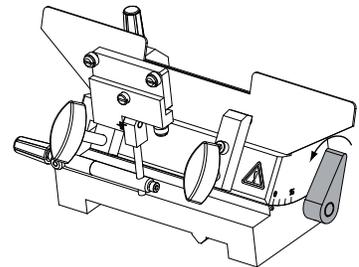

Set the angle of the holder between 4° and 5° (depending on the blade facet angle), then lock it at that angle by pushing the right hand lever away from you.

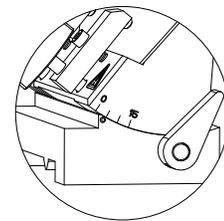

Adjust the angle of attitude of the anti roll plate by lining up the datum line with the third line of the head. Use an Allen key to slacken the head as necessary; tighten after adjustment.

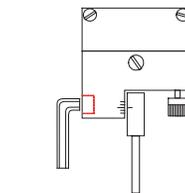

#### Note

- 1 *If the sections appear to curl slightly after cutting, reduce the angle of attitude slightly.*

Ensure that there is a good edge i.e. there are no 'nicks' - on the anti roll plate. Use the brush supplied to keep the anti roll plate, the blade, and the clamp clean.

## Note

- 1 To prevent the anti-roll plate heating up, make sure that it is kept close to the knife

Use the two adjusting screws to set the anti-roll plate gap. Place a thin strip of paper between the knife/blade and the anti-roll plate. Check that it is just free to move - all along the gap - left to right.

Use the adjusting screw (a) on the anti roll plate support bar to set the approximate height for the anti roll plate. Loosen and tighten the Allen screw as necessary.

Use the height adjust control (b) to set the precise height of the anti-roll plate. You should JUST be able to see the top of the anti-roll plate above the edge of the knife/blade. Fine adjust so that the specimen JUST misses the anti roll plate when cutting.

Use the nylon adjuster screw (c) to rectify any slew of the anti roll plate. Make sure that the top of the anti roll plate is parallel with the top edge of the knife/blade.

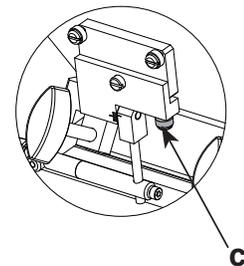
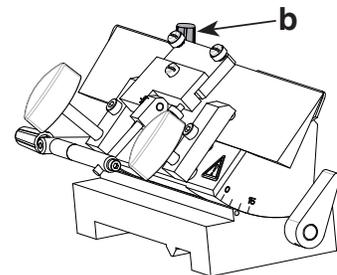
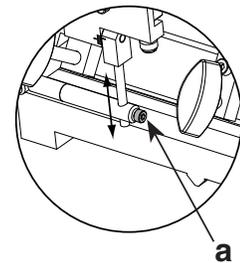
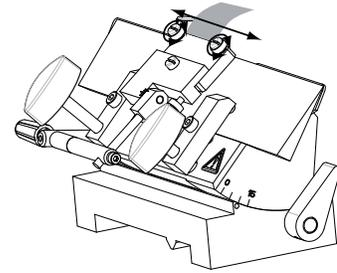

### 3.6.4 TO FIT A DISPOSABLE BLADE

Slide the Blade Transporter as far as possible to the right.



**ALWAYS USE MESH GLOVES TO AVOID INJURY WHEN HANDLING DISPOSABLE BLADES. USE THE DISPENSER WHEN FITTING A NEW BLADE**



**ALWAYS PLACE THE PLASTIC KNIFE GUARD OVER THE CENTRE OF PORTION OF THE KNIFE WHENEVER THE INSTRUMENT IS NOT BEING USED FOR CUTTING**

Swing the anti roll plate away from the blade clamp by turning the control bar toward you.

Move the blade clamp lever to the left (clockwise) until it is vertically down.

Push the end of the blade to be installed part way out of the dispenser and put its left end under the plate of the blade clamp. Slide the blade to the left until its right hand end drops into the recess of the blade transporter.

Use the transporter to move the blade into its first cutting position, then push the blade clamp lever to the right (counter clockwise) to lock the blade in position.

With use it is possible that the blade clamp mechanism loosens slightly so that the blade does not clamp properly. Adjust the screw (*d*) at the rear of the Knife Holder as necessary to obtain the required locking action.

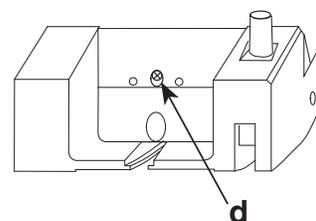
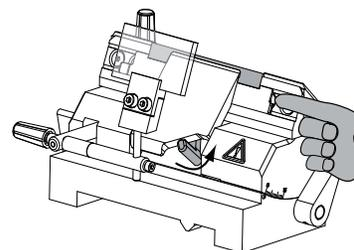
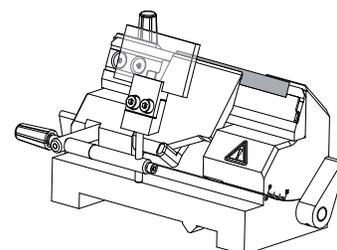
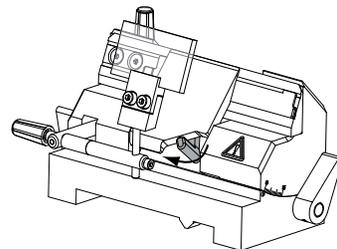
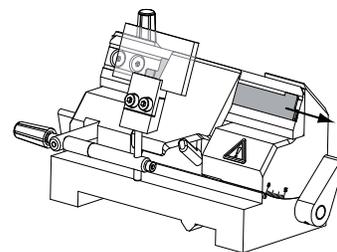



**USE THE CORRECT BLADE TYPE FOR THE BLADE HOLDER - EITHER LOW OR HIGH PROFILE**

### 3.6.5 TO SET UP THE KNIFE HOLDER AND ANTI-ROLL PLATE FOR DISPOSABLE BLADES

#### Note

- 1 *These are the recommended settings. You may need further minor adjustments to obtain best results.*

Make sure that the top edge of the glass plate is parallel to the knife. If adjustment is necessary, use a 3mm A/F Allen key to loosen the two screws that hold the assembly together.

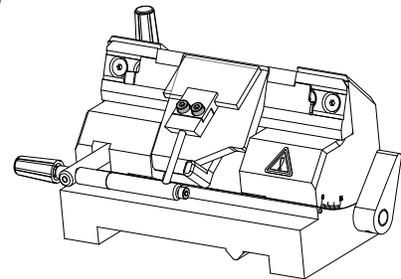

Move the glass plate carefully until the top edge is parallel to the knife. Hold the glass plate firmly in position and tighten up the two screws.

Use the Height Adjust Control (*a*) to set the height of the Anti-Roll Plate relative to the knife edge. Once adjusted, further movement should not be required.

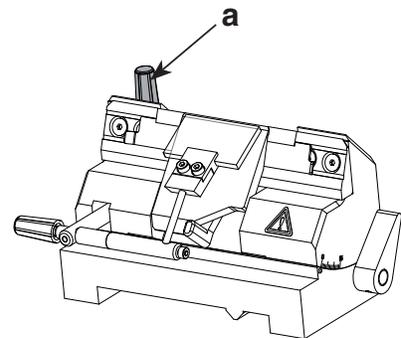

#### Note

- 1 *This is a very fine adjustment. If it is set too low, sections will curl above the Anti-Roll Plate. If it is set too high, the block will foul the Anti-Roll Plate.*

When cutting sections, lower the Anti-Roll Plate carefully into position on the knife blade - do not let it drop onto the blade. Any damage to the edge of the glass will result in loss of performance.

Ensure that there is a good edge i.e. there are no 'nicks' - on the anti roll plate. Use the brush supplied to keep the anti roll plate, the blade, and the clamp clean.



**THE EDGES OF THE GLASS ANTI-ROLL PLATE ARE SHARP**

**Note**

- 1 To prevent the anti-roll plate heating up, make sure that it is kept close to the knife

### 3.6.6 SPECIMEN HEAD

The Specimen Head is designed to accept a Thermo Cryocassette that already has a frozen specimen mounted.

The frozen specimen on the Cryocassette is held in the Specimen Head by a Quick Release Cryocassette Clamp. The Clamp lever (*b*) at the top of the Specimen Head operates a moveable jaw that holds the Cryocassette firmly in position.

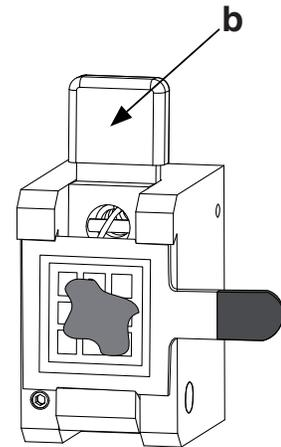

To install a cryocassette in the Quick Release Clamp:

- i Pull the Clamp lever (*b*) towards you.
- ii Fit the cryocassette under the two fixed jaws as shown.
- iii Release the Clamp lever.

#### 3.6.6.1 Fixed Orientation Head (*supplied with instrument*)

To secure the cryocassette in the Fixed Head, insert the shaft on the Quick Release Clamp into the hole in the Fixed Head and tighten the knob on top of the Fixed Head (*c*).

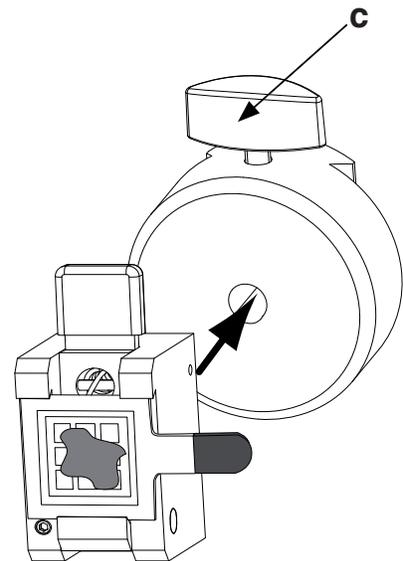

### 3.6.6.2 Fine Orientation Head

Unscrew the shaft on the Quick Release Clamp to remove it. Screw the Quick Release Clamp onto the shaft in the centre of the Fine Orientation Head and turn the Orientation Clamp (*c*) on the right hand side of the Orientation Head away from you to secure the Clamp.

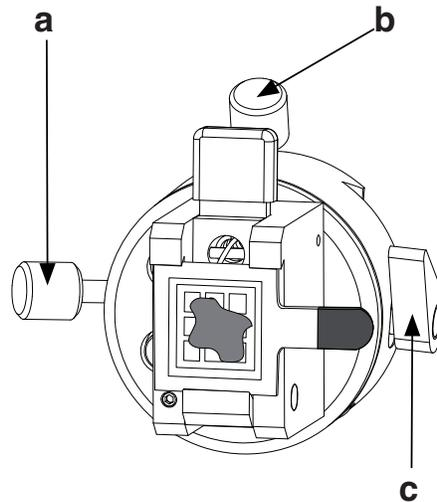

To adjust the up-to-down and left-to-right orientation of the specimen before sectioning takes place, turn the Orientation Clamp towards you to unlock the clamp.

Use the knurled rotary control (*b*) at the top of the Orientation Head to set the vertical orientation of the specimen. Clockwise rotation tilts the specimen upward; counter-clockwise rotation tilts the specimen downward.

Use the knurled rotary control (*a*) at the left hand side of the Orientation Head to set the horizontal orientation of the specimen. Clockwise rotation tilts the specimen to the left; counter-clockwise rotation tilts the specimen to the right.

Turn the Orientation Clamp away from you (clockwise) to lock the specimen in the required position.

### 3.6.6.3 Coarse Orientation Head

Insert the shaft of the Quick Release Clamp into the hole in the centre of the Coarse Orientation Head. Turn the Orientation Clamp (*d*) on the left hand side of the Orientation Head to secure the Clamp.

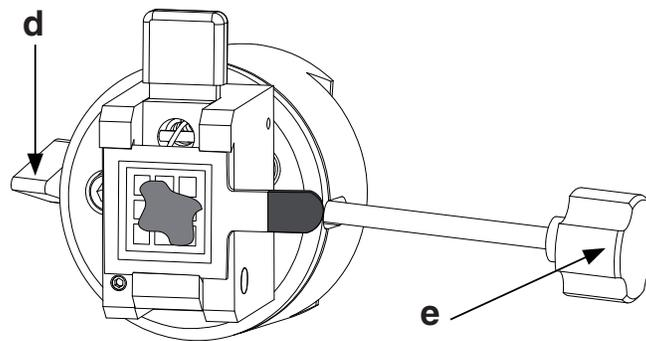

To adjust the up-to-down and left-to-right orientation of the specimen before sectioning takes place, first turn the knob (*e*) on the end of the adjustment shaft towards you to unlock the movement of the head.

Move the adjustment shaft to set the vertical and horizontal orientation of the specimen.

When the specimen is in the correct position, tighten the knob (*e*) to lock it into position.

### 3.6.6.4 To Change the Orientation Heads

Each Orientation Head is fitted in the same way.

To remove the Orientation Head, loosen the allen screw at the side of the Orientation Head support (*f*).

Slide the Orientation Head up to remove the head.

To replace the Orientation Head, locate the dovetail on the Head with the dovetail on the support. Slide it downwards as far as it will go. Tighten up the allen screw to secure it.

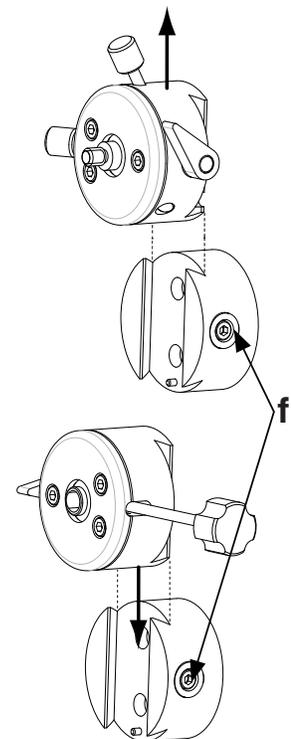

# OPERATION

## 4.1 INTRODUCTION

When the instrument is not in use, lock the Handwheel and keep the instrument switched on, with the sliding window closed and locked, and the Refrigerated Chamber at approximately  $-15^{\circ}\text{C}$  to  $-20^{\circ}\text{C}$ .

The Control Panel is disabled, and the instrument is inoperable, when the keyswitch is vertical. The yellow 'Locked' indicator is lit when the Control Panel is disabled and the key can be removed to keep the instrument locked.

Insert the key in the keyswitch and turn it clockwise to unlock the Control Panel. The Locked indicator is not lit when the Control Panel is enabled, and the key cannot be removed.

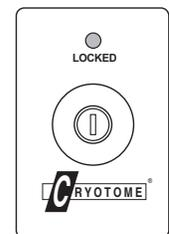

If [WINDOW LOCK] is lit, press the [WINDOW LOCK] push-button once to release the window and extinguish the indicator.

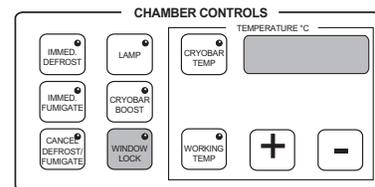

### Note

- 1 Performance will be adversely affected if the ambient temperature exceeds  $30^{\circ}\text{C}$  ( $86^{\circ}\text{F}$ )

## 4.2 MOUNTING A SPECIMEN



**ALWAYS BE AWARE THAT ANY SAMPLE MAY POSE A BIOHAZARD. TAKE SUITABLE PRECAUTIONS**

Lower the heat sink on to the Cryobar and then press and release [CRYOBAR BOOST].

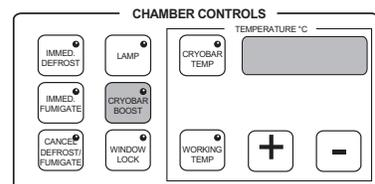

Wait for a few minutes then press **[CRYO BAR TEMP]** to check that the temperature of the peltier element in the Cryobar is between  $-50^{\circ}\text{C}$  and  $-60^{\circ}\text{C}$  i.e. approximately  $20^{\circ}\text{C}$  below the normal Cryobar temperature,

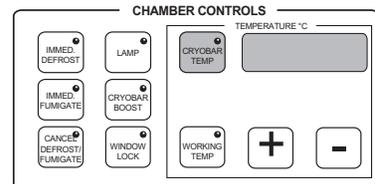

**THE CRYO BAR OR PELTIER ELEMENT ARE EXTREMELY COLD AND CAN CAUSE FROSTBITE. DO NOT TOUCH THEM WITH BARE HANDS**

Use the table in Appendix C to select the suggested temperature for the specimen to be cut. To set the temperature, keep **[WORKING TEMP]** pressed while using the **[+]** or **[-]** push-buttons to set the Chamber temperature to the required temperature.

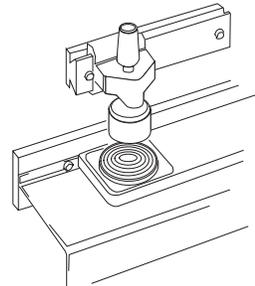

There are several methods of embedding a specimen for work on a cryotome. The following instructions describe one suggested method.

Take a clean Cryocassette that has been held at room temperature. Apply a layer of specimen embedding medium, such as Cryomatrix™ or Cryochrome™, to the grooved side of the Cryocassette, then lift the heat sink sufficiently to allow you to place the Cryocassette on the Peltier platform of the Cryobar.

*Cryomatrix™ and Cryochrome™ are proprietary Thermo consumables*

When the mountant starts to freeze, place the specimen directly from the cutting-up board on to the mountant and press down lightly to eliminate any entrapped air.

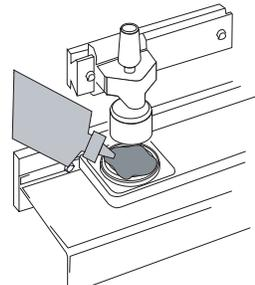

Add a final coat of mountant and allow it to freeze.

Lower the heat sink gently over the specimen. Take care not to touch the specimen. Allow the specimen and mountant to freeze until both are opaque and firm.

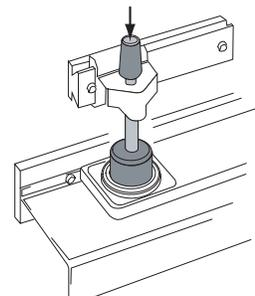



### TO AVOID THE POSSIBILITY OF CROSS CONTAMINATION:

- 1 MAKE SURE THAT THE PELTIER PLATFORM OF THE CRYOBAR IS COLD ENOUGH
- 2 DO NOT USE TOO MUCH PRESSURE WHEN APPLYING THE HEATSINK.
- 3 MAKE SURE THE CRYOCASSETTES AND HEAT SINKS ARE CLEAN BEFORE USE

### Notes

- 1 *Do not use too much mountant or get it onto the sides or back of the Cryocassette.*
- 2 *Normal compressor operation resumes 10 minutes after cryobar boost is initially enabled. During this period, you may:*
  - i *Manually switch off the cryobar boost facility by pressing [**CRYOBAR BOOST**].*
  - ii *Enable Cryobar Boost for a further 10 minutes by pressing [**CRYOBAR BOOST**] while the Cryobar Boost LED is flashing.*

Turn the handle of the handwheel to the 12 o'clock position, and apply the brake.

Transfer the Cryocassette, complete with frozen specimen, from the Cryobar to the Specimen Head and secure it in position with the Specimen Clamp (see 3.6.5).

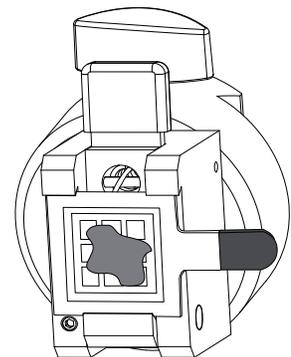

## 4.3 TO SET THE KNIFE HOLDER FOR CUTTING SPECIMEN

Turn the handwheel to 3 o'clock and lock it in position. Pull the pivoting lever at the left hand side of the Knife Holder towards you then carefully push the base of the Knife Holder along the carriage away from you until the blade is almost touching the specimen. Lock the Knife Holder in position by pushing the pivoting lever away from you.

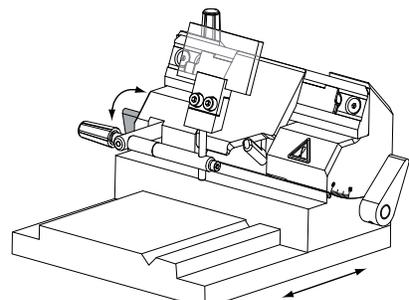

[E only]: Alternatively, if sufficient 'Travel Available' is indicated on the Specimen Travel Indicator, advance the specimen towards the knife using the double chevron (coarse), then the single chevron (fine), push-buttons of the miniature control panel on the left hand side.

If necessary use the Rotary Control to obtain fine positioning of the specimen with respect to the knife. The Rotary Control moves the specimen 8 microns ( $\mu\text{m}$ ) with each 'click'.

[Standard only]: Advance the specimen towards the knife using the Rewind/Advance knob on the Advance Control Panel.

## 4.4 TO CUT SECTIONS



**KEEP THE WINDOW CLOSED WHEN CUTTING OR INJURIOUS AEROSOLS MAY BE INHALED.**

At the Micron Selector panel use the [+] and [-] push-buttons [E only] or the Micron Selector Knob [Standard only] to set the required section thickness.

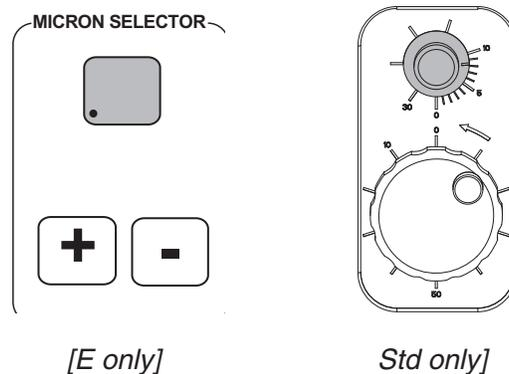

To cut sections, turn the Handwheel smoothly. The instrument performs a single cutting stroke with each full revolution of the Handwheel and cuts a section of the specimen.

Continue to turn the Handwheel until the required number of sections have been cut. The Specimen automatically advances by the set distance before the start of each cutting stroke.

## 4.5 TO REMOVE THE SPECIMEN FROM THE CRYOCASSETTE

When the last section is cut, lock the Handwheel at the 3 o'clock position. Remove the cryocassette from the clamp.

If the specimen is to be stored frozen, wrap it in metal foil before putting it into a freezer. Do not store it in the Refrigerated Chamber of the Cryotome.

If the specimen is to be fixed, allow it to thaw before placing it in a suitable fixative; otherwise discard it by the usual method for unfixed tissue. Brush away any debris that has collected around the Cassette Clamp or Head.

Decontaminate and clean the Cryocassette.

## 4.6 HOUSEKEEPING

**Daily:** Decontaminate the specimen brush by putting it overnight in a solution of 10% Formalin. Wash and dry the brush each morning before use.

**After Fumigation:** Carefully remove the debris tray, Knife Holder and any debris. Wash in running hot water initially to remove the debris, then immerse overnight in a solution of 10% Formalin. The following day, wash, dry, and replace in the Cryotome.

Wash the Refrigerated Chamber with alcohol or warm soapy water to remove debris, and rinse the outlet tube in the bottom of the chamber, and the grill beneath the fins of the heat exchanger with a solution of 10% Formalin.



**ALWAYS REFER TO MATERIAL SAFETY DATA SHEET (MSDS) FOR REAGENTS SPECIFIED IN APPENDIX B**

# CLEANING AND MAINTENANCE

## 5.1 GENERAL

It is important that decontamination and cleaning of the instrument becomes an automatic routine - especially if the source of material is unknown. It is recommended that a log is kept which lists:

- i Material Cut.
- ii Degree of Risk.
- iii Decontamination Performed.
- iv Name of User.
- v Department.

Cleaning is a part of good laboratory housekeeping practice. External cleaning requirements are straightforward. The Refrigerated Chamber should only be washed and cleaned after the Chamber is thoroughly decontaminated by fumigation. The instrument should be inspected for obvious damage whenever it is cleaned. If any damage is found, contact your Thermo supplier.

Routine maintenance by the Operator does not require the removal of any panels or fixtures. Precision maintenance and adjustment should only be performed by Thermo trained Service personnel and it is recommended that a Maintenance Contract is obtained from our Service Department.



**IF HAZARDOUS MATERIAL IS SPILT ON, OR INSIDE, THE INSTRUMENT, THE USER SHOULD CARRY OUT THE APPROPRIATE DECONTAMINATION**  
(see World Health Organisation 'Laboratory Biosafety Manual')



**CLEANING OR DECONTAMINATION METHODS, OTHER THAN THOSE RECOMMENDED IN THE OPERATOR GUIDE, SHOULD BE CHECKED WITH A THERMO AGENT TO ENSURE THAT THE PROPOSED METHOD WILL NOT DAMAGE THE EQUIPMENT**



**ALWAYS REFER TO MATERIAL SAFETY DATA SHEET (MSDS) FOR REAGENTS SPECIFIED IN APPENDIX B**



**ALWAYS WIPE UP ANY SPILLS IMMEDIATELY. IN THE EVENT OF A MAJOR SPILLAGE, DISCONNECT THE INSTRUMENT FROM THE MAINS SUPPLY WITHOUT DELAY AND DO NOT RECONNECT AND SWITCH ON UNTIL THE INSTRUMENT HAS BEEN THOROUGHLY DRIED OUT AND CHECKED BY A SERVICE ENGINEER.**



**POTENTIALLY LETHAL VOLTAGES ABOVE 110V a.c. ARE PRESENT INSIDE THE UNIT. DO NOT REMOVE ANY ACCESS COVERS**

**WARNING** Always wear protective gloves when you clean or decontaminate the Cryotome to protect yourself against the effects of chemicals

**WARNING** Do not use any chemicals that may interact with materials of manufacture. If in doubt, check with Thermo Service department

**WARNING** Do not use abrasive compounds or metal components to clean the Cryotome or its components and accessories

## 5.2 FUMIGATION

Carefully load the heating trough in the Refrigerated Chamber with 2 ml of concentrated formalin solution. Close the window .

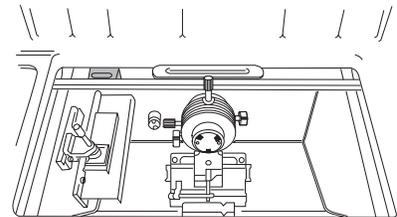

Press **[WINDOW LOCK]** and check that the push-button indicator is lit.

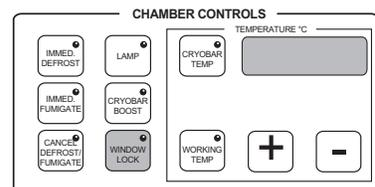

To start the fumigation immediately, or to program in a start time, press **[IMMED FUMIGATE]** in the Chamber Controls panel.

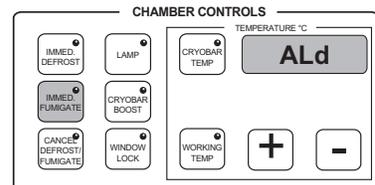

Fumigation takes place at the same time every day if the 'DAY 8' option is selected in the Fumigation program. Before the scheduled time for fumigation each day it is therefore essential that:

- i 2 ml of concentrated formalin is in the heater trough;

- ii the window is shut and locked;
- iii the key is removed from the Control Panel.

Normally, the chamber will return to the set temperature after fumigation and the formaldehyde will condense. However, if 'DAY 9' is set in the fumigation program, the instrument goes into 'Standby Mode' (PSAVE) after fumigation is completed. To neutralise the formaldehyde fumes, carefully open the window and insert a beaker containing 10 ml of Ammonia SG 0.88 in the Refrigeration Chamber to absorb residual formaldehyde from the atmosphere in the Chamber. Keep the chamber closed while allowing the beaker to stand for an hour.

#### Note

- 1 *For safety, the fumigation cycle cannot take place if the window is not closed and locked.*

**WARNING** If the Cryotome is not refrozen after fumigation has taken place, formaldehyde fumes will be present in the chamber. Take care when opening the window.

## 5.3 CLEANING

Use a proprietary spray foam cleanser, or a cloth damped in soapy water, and a dry polishing cloth to periodically clean the outside of the cabinet. **DO NOT USE EXCESSIVE WATER.**

Periodically wash the Refrigerated Chamber with alcohol or warm soapy water to remove debris. Rinse well with a solution of 10% Formalin. Wash the Formalin solution down the outlet tubes in the bottom of the chamber, and beneath the fins of the heat exchanger.

Wipe and dry the walls of the Refrigerated Chamber carefully using a chamois leather damped with the cleaning solution followed by a dry polishing cloth.

The high polish finish inside the Refrigerated Chamber is designed to minimise the adhesion of particles to the side walls.

**WARNING** Do not use scouring powder or harsh detergents or you will degrade the polished finish

### 5.3.1 TO CLEAN THE KNIFE HOLDER

**WARNING** Remove the knife or blade before cleaning Knife Holder

It is important to keep the Knife Holder clean. To clean behind the clamp plate, drip xylene behind the clamp plate to loosen any wax build up. Remove any wax build up with a fine brush.

## 5.4 DEFROSTING

**WARNING** Remove the specimen from the cryobar before defrosting. The cryobar will reach temperatures of +80°C during the Defrost cycle

The accumulation of frost within the Refrigerated Chamber reduces the efficiency of the refrigeration system. Press **[IMMED DEFROST]** if the cooling coils are frosted up, or if the performance of the refrigeration unit deteriorates.

Alternatively, use the 'DAY 8' setting of the timer to defrost for 15 minutes at a regular time each day. The temperature of the Refrigerated Chamber will not normally rise above 0°C.

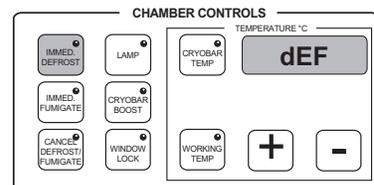

### Note

- 1 This cycle is used to remove the build up of small amounts of ice around the main evaporator coil and the cooling fins at the rear of the cryo-chamber.

For a thorough defrost of the complete instrument, use the Fumigate cycle every week. This takes about 5 hours and will totally defrost all of the pipes. The resulting condensate will flow into the waste bottle and the temperature of the cryo-chamber will rise above 0°C during the cycle.

## Note

- 1 *It is not necessary to use formalin during the Defrost/Fumigate cycle*

The waste bottle collects water from the cooling coils of the heat exchanger. It also collects debris when the Refrigerated Chamber is washed down so the contents must be disposed of in an appropriate manner.



**ALWAYS KEEP AT LEAST 200ml OF 10% FORMALIN SOLUTION OR SIMILAR DE-CONTAMINANT IN THE WASTE BOTTLE. MAKE SURE THAT THE END OF THE DRAINTUBE IS KEPT SUBMERGED.**

If condensation appears on the window in conditions of high relative humidity, set the Window Boost switch at the rear of the instrument to 'ON'.

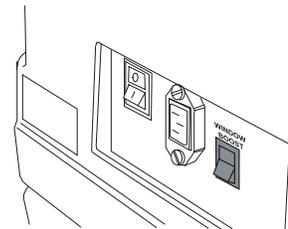

## Note

- 1 *The window boost facility provides extra de-misting power in conditions of high humidity*
- 2 *The refrigeration system operates less efficiently if the window boost facility is left switched on unnecessarily*

## 5.5 MAINTENANCE



**SWITCH OFF THE INSTRUMENT AT THE MAINS AND REMOVE THE PLUG FROM THE WALL SOCKET BEFORE PROCEEDING WITH ANY MAINTENANCE.**

### 5.5.1 TO REMOVE THE LAMP TUBE

Lift up the top cover.

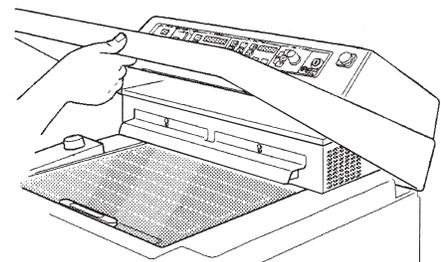

Loosen the two screws that hold the shade.

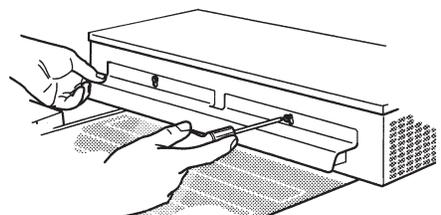

Slide the shade along its two keyhole slots, then lift it off.

Grip the fluorescent tube firmly, rotate it 90°, and pull it towards you to slide it from the end connectors.

### 5.5.2 TO FIT A LAMP TUBE

Hold the replacement tube firmly at the ends and align the connector pins with the slots at each end of the fitting.

Carefully push the tube into place.

Rotate the tube a quarter turn.

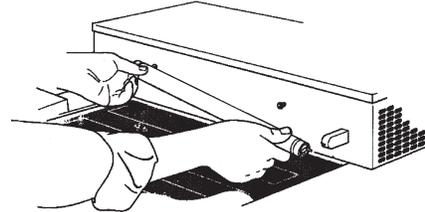

Fit the shade into its two keyhole slots and push it into position.

Tighten the two screws that hold the shade, and replace the top cover.

## 5.6 ELECTRICAL PROTECTION

The mains input supply feeds the Cryotome via a trip device that interrupts the electrical supply to the instrument if an internal fault occurs. The trip replaces the function of a fuse.

When the electrical protection device trips, the mains switch goes to its **O** position (OFF) and the instrument becomes inoperative.

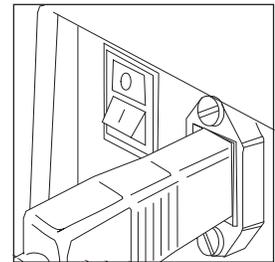

If the protection circuit operates, this will normally indicate a compressor problem. Check that there is adequate space around the outside of the unit for cooling air and that the inlet grill on the right hand side is free of obstructions and dust. Allow 1 hour for the compressor to cool before attempting to reset the trip circuit.

Press and release the **I** side of the mains ON/OFF switch to switch the instrument on again. If the protection circuit keeps tripping the switch, contact your Thermo Service representative.



**ELECTRICAL PROTECTION IS INCLUDED TO PROTECT THE OPERATOR AND THE INSTRUMENT. DO NOT ATTEMPT TO OVERRIDE THE PROTECTION TRIP**

**WARNING**

**Portable Appliance Testing (PAT) should only be carried out annually to avoid damaging the equipment**

**WARNING**

**Flash testing should only be carried out when absolutely necessary as damage to sensitive electronic devices may occur**

# TROUBLE SHOOTING

## 6.1 GENERAL

Correct service and maintenance is essential for the long term serviceability of precision engineered products such as the Cryotome. We strongly recommend that a Thermo Service Contract is used to ensure future reliability, and consistency of performance.

Cryotome has self test routines built in so that fault codes (**F:(Number)**) show in the displays if malfunctions occur. No operator response is involved following a fault code other than to contact your Thermo Engineer for service.

Table 1 lists basic instrument function problems and solutions.

Table 2 lists other problems and their causes that are not shown in the displays.

Table 3 lists alarm signals, their causes, and the remedial action to be taken.

If a fault indication continues or recurs, remove the samples from the refrigerated chamber and store them in a suitable refrigerated container and contact your Thermo Service Representative.

**TABLE 1 INSTRUMENT FUNCTION**

SYMPTOM	CAUSE	REMEDY
The Cryotome does not respond when the mains power is switched on	<ol style="list-style-type: none"> <li>1 The instrument is still carrying out initial tests</li> <li>2 No mains supply</li> <li>3 The mains fuses have blown</li> </ol>	<ol style="list-style-type: none"> <li>1 Wait 30 seconds for the initial tests to finish</li> <li>2 Connect the power lead Switch on the mains power and instrument main power switch <i>(see paragraphs 3.4 and 3.5)</i></li> <li>3 Replace the mains fuse Replace the instrument fuses <b>(Note only a technically competent person should replace fuses)</b></li> </ol>
The Cryotome is powered up, but does not respond correctly	<ol style="list-style-type: none"> <li>1 The Cryotome may have started incorrectly</li> </ol>	<ol style="list-style-type: none"> <li>1 Switch off the instrument. Wait for 30 seconds. Switch on the main power switch.</li> </ol>

**TABLE 2 PROBLEMS - WHEN SECTIONING**

<b>SYMPTOMS</b>	<b>POSSIBLE CAUSE</b>	<b>REMEDY</b>
Specimen cracks as it is frozen	<ol style="list-style-type: none"> <li>1 Too rapid freezing</li> <li>2 Specimen too thick</li> </ol>	<ol style="list-style-type: none"> <li>1 Cut specimen into thinner block.</li> </ol>
Specimen falls off Cryocassette.	<ol style="list-style-type: none"> <li>1 Specimen too thick.</li> <li>2 Cryocassette too cold before mountant added.</li> <li>3 Specimen unsupported.</li> </ol>	<ol style="list-style-type: none"> <li>1 Cut specimen into thinner block.</li> <li>2 Reduce time before adding mountant. (<i>Should be at room temperature</i>)</li> <li>3 Give the specimen more support.</li> </ol>
Specimen advances but does not cut.	<ol style="list-style-type: none"> <li>1 Knife loose.</li> <li>2 Cryocassette loose.</li> <li>3 Specimen not firmly stuck to the Cryocassette.</li> <li>4 Knife angle incorrect.</li> </ol>	<ol style="list-style-type: none"> <li>1 Make sure that the knife is clamped correctly</li> <li>2 Make sure that the Cryocassette is fitted and clamped correctly.</li> <li>3 Re-mount the specimen on the Cryocassette using adequate mountant.</li> <li>4 Increase knife angle.</li> </ol>
Sections roll-up.	<ol style="list-style-type: none"> <li>1 Incorrect gap between Anti Roll Plate and knife.</li> <li>2 Anti Roll Plate too low.</li> <li>3 Incorrect Anti Roll Plate angle.</li> </ol>	<ol style="list-style-type: none"> <li>1 Adjust Anti Roll Plate gap.</li> <li>2 Raise the height of the Anti Roll Plate.</li> <li>3 Adjust the angle between the Anti Roll Plate and the knife.</li> </ol>
Sections thaw when cut.	<ol style="list-style-type: none"> <li>1 Cutting equipment not cold enough.</li> </ol>	<ol style="list-style-type: none"> <li>1 Allow more time for the knife and the Anti Roll Plate to cool.</li> </ol>
Sections are puckered.	<ol style="list-style-type: none"> <li>1 The knife is dirty.</li> <li>2 The knife is damaged.</li> <li>3 The Anti Roll Plate is nicked.</li> </ol>	<ol style="list-style-type: none"> <li>1 Remove and clean the knife.</li> <li>2 Check and, if necessary, sharpen the knife.</li> <li>3 Inspect and, if necessary, replace the Anti Roll Plate.</li> </ol>
Sections appear with fine cracks parallel to the edge of the knife.	<ol style="list-style-type: none"> <li>1 Specimen is too cold when cut.</li> </ol>	<ol style="list-style-type: none"> <li>1 Usually applies to fixed tissue. Soak in Dextran before freezing.</li> </ol>

**TABLE 2 (continued) PROBLEMS - WHEN SECTIONING**

<p>Sections show ice artifacts.</p>	<ol style="list-style-type: none"> <li>1 Specimen not frozen quickly enough.</li> <li>2 Specimen too thick.</li> </ol>	<ol style="list-style-type: none"> <li>1 Allow Cryoboost longer time before adding mountant and admitting specimen.</li> <li>2 Cut thinner.</li> </ol>
<p>Sections show signs of the effects of vibration.</p>	<ol style="list-style-type: none"> <li>1 Knife not supported correctly.</li> <li>2 Knife angle incorrect.</li> <li>3 Specimen not sufficiently secured.</li> <li>4 The blade is not clamped securely</li> </ol>	<ol style="list-style-type: none"> <li>1 Disposable knives are most vulnerable. Make sure that the knife is fitted correctly and that there is no debris under the knife clamp.</li> <li>2 Check and correct the knife angle.</li> <li>3 Re-freeze as necessary.</li> <li>4 Make sure the blade clamping is secure</li> </ol>
<p>Sections thick and thin.</p>	<ol style="list-style-type: none"> <li>1 Blunt knife</li> <li>2 Knife angle too shallow.</li> <li>3 Specimen not secure.</li> <li>4 Knife Holder is loose</li> </ol>	<ol style="list-style-type: none"> <li>1 Sharpen knife.</li> <li>2 Widen the knife angle</li> <li>3 Re-freeze and secure the specimen.</li> <li>4 Make sure the Knife Holder is secure on the base</li> </ol>
<p>Sections stick to the Anti Roll Plate.</p>	<ol style="list-style-type: none"> <li>1 Dirt or contaminant on the Anti Roll Plate.</li> <li>2 Cutting equipment not cold enough.</li> </ol>	<ol style="list-style-type: none"> <li>1 Use the brush to clean the Anti Roll Plate.</li> <li>2 Allow more time for the knife and the Anti Roll Plate to cool.</li> </ol>
<p>Sections are split vertically.</p>	<ol style="list-style-type: none"> <li>1 The knife is dirty.</li> <li>2 The knife is blunt.</li> <li>3 The knife/blade, anti-roll plate or clamp plate are damaged</li> </ol>	<ol style="list-style-type: none"> <li>1 Remove the knife and clean and sharpen it. <b>WEAR MESH GLOVES.</b></li> <li>2 Examine the knife/blade, anti-roll plate and clamp plate and replace if necessary</li> </ol>

**TABLE 3 ERROR MESSAGES**

<b>SYMPTOMS</b>	<b>POSSIBLE CAUSE</b>	<b>REMEDY</b>
<b>LOBAT</b>	1 Internal back-up battery is losing charge	1 Switch on/leave the unit switched on. 2 Have the battery replaced.
<b>Err 1</b>	1 Invalid pushbutton entry. 2 Too many pushbuttons pressed simultaneously.	1 Use the correct pushbutton. 2 Re-enter pushbutton selections correctly.
<b>Err 2</b>	1 Invalid pushbutton entry during Defrost/ Fumigate. 2 Defrost is inhibited because the Cryobar and Chamber are too warm.	1 Use the correct pushbutton, or wait for the function to end. 2 Adjust working temperature to a lower chamber temperature.
<b>Err 3</b>	Not Allocated	None
<b>Err 4</b>	1 Window lock error - cannot lock or unlock.	1 Make sure that the window is closed correctly. 2 Contact the Thermo Service Engineer.
<b>Err 5</b>	Not Allocated	None
<b>Err 6</b>	Not Allocated	None
<b>Err 7</b>	Not Allocated	None
<b>Err 8</b>	Not Allocated	None

# SPECIFICATION AND ACCESSORIES

## 7.1 SPECIFICATION

### 7.1.1 Physical

Width	660 mm	(26 ins)
Depth	640 mm	(25¼ ins)
Height	1070 mm	(42¼ ins)
Weight	120 kg	(265 lbs)
Mounting	4 off movable castors, (front 2 retractable)	

### 7.1.2 Electrical

Power Supply Voltages:	220 - 240 V a.c. (~); 50/60 Hz; 1700VA
	110 - 120 V a.c. (~); 50/60 Hz; 1400VA
	(Voltage is set at the factory)

Maximum supply voltage fluctuations not to exceed  $\pm 10\%$  of nominal voltage

### 7.1.3 Power Demand Characteristics

NOMINAL a.c. INPUT		MINIMUM VOLTAGE @ I (max)	MAXIMUM VOLTAGE AT NO LOAD	I (max) MAXIMUM CURRENT WHEN COMPRESSOR STARTS -	MAXIMUM SUPPLY IMPEDANCE
(V)	(Hz)	(V)	(V)	(A)	(V/A)
230;	50/60	198	264	20	1.0
115;	50/60	99	121	44	0.5

#### Notes

- 1 I (max) = Peak Current
- 2 Peak Current is for 22 secs max with stalled rotor.
- 3 Voltage drop affects compressor start capability.
- 4 Supply impedance affects compressor start-up capability

### 7.1.4 Fuses

Mains plug fuse (where applicable)	13A 250V
Mains fuses (x 2)	T3.15A 250V (Part number P05847)

Note: Fuses should only be replaced by technically competent personnel

### 7.1.5 Switch convention

I	Power On
O	Power Off

### 7.1.6 Environment

General	Indoor use only
Temperature ( <i>operation</i> )	+10°C to +35°C
Temperature ( <i>transit / storage</i> )	-25°C to +55°C (+70°C for short exposure)
Humidity	80% max. for temperatures < 31°C 50% max. for temperatures 31°C to 40°C (Non-condensing environment)
Altitude	up to 2000m (6,500 feet)
Pollution degree	2
Over voltage category	II

### 7.1.7 Thermo part numbers

Standard Cryotome	
220 - 240 V; 50/60 Hz ( <i>English</i> )	0620
220 - 240 V; 50/60 Hz ( <i>German</i> )	0620/G
220 - 240 V; 50/60 Hz ( <i>French</i> )	0620/F
110 - 120 V; 50/60 Hz	0620/110
Cryotome E	
220 - 240 V; 50/60 Hz ( <i>English</i> )	0620E
220 - 240 V; 50/60 Hz ( <i>German</i> )	0620E/G
220 - 240 V; 50/60 Hz ( <i>French</i> )	0620E/F
110 - 120 V; 50/60 Hz	0620E/110

### 7.1.7 Centre of Gravity Position *(see also page 5)*

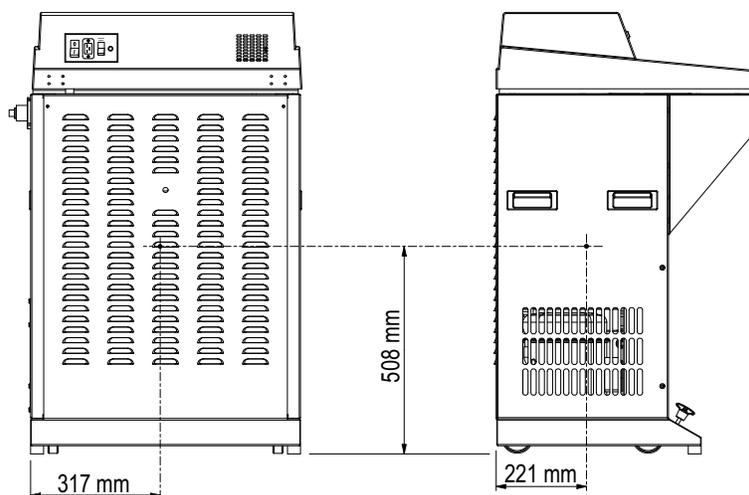

### 7.1.8 Microtome

Rotary rocking microtome mounted outside refrigerated chamber	
Total specimen advance	25 mm [ <i>E only</i> ]; 12mm [ <i>Std only</i> ]
Section thickness range [ <i>Std only</i> ]	0 to 30 µm in increments of 1 µm.
Section thickness range [ <i>E only</i> ]	0 to 20 µm in increments of 1 µm. 20 to 60 µm in increments of 5 µm.
Retraction	40 µm on upward stroke.

## 7.2 ACCESSORIES

INSTRUMENT ACCESSORIES		QUANTITY	PART NUMBER
Solid Knife Holder with Anti Roll Plate			0620-023
High Profile Disposable Blade Holder with Anti Roll Plate			0620-021H
Low Profile Disposable Blade Holder with Anti Roll Plate			0620-021L
Orientation Heads:	Fine Orientation Head		0620-006
	Coarse Orientation Head		0620-008
Cryocassettes	25mm dia circular	5	0620-405
	35mm dia circular	5	0620-041
	45mm dia circular	5	0620-036
	35mm square	5	0620-039
	28 x 40mm	5	0620-026
	25mm ( <i>heavy duty</i> )	5	0603
	8mm circular biopsy	5	0620-007
	25.4mm (1") square	5	0620-001
	Variety Pack	5	A77210155
MOHS Organiser Tray		1	77230046

See Catalogue for details of solid knives, disposable blades, additional consumables and accessories.

## 7.3 SPARES

INSTRUMENT SPARES		QUANTITY	PART NUMBER
Anti-Roll Plate Glass ( <i>Disposable Knife Holder</i> )			A77210086
Anti-Roll Plate Perspex ( <i>Solid Knife Holder</i> )			77230019
Brush			P12940
Debris Tray			0620-004
Footswitch			77220533
Front Panel Keys		2	P13571
Handwheel Assembly			0620-118
Handwheel Bolt			0300-095
Handwheel Bolt Key			0300-124
Mains Lead		UK	P13291
		EU	P13290
		US	P13292
Operator Guide ( <i>available in different languages</i> )			77210163xx
Plastic Knife Guard			A77210064
Quick Release Clamp			0620-807
Shelf			0620-002

# WARRANTY STATEMENT

We are proud of our quality and reliability, and of our after-sales service. We continuously strive to improve our service to our customers.

Please ask your distributor or representative about Service Contracts which can keep your purchase in peak condition for many years to come.

Warranty provisions necessarily vary to comply with differences in national and regional legislation, and you can find details in your delivery documents or from your dealer or representative.

Please note that your warranty may be invalidated if:

- the instrument is modified in any way,
- accessories and reagents are used that are not approved by Thermo, or
- the instrument is not operated or maintained in accordance with the instructions in this Operator Guide.

# Declaration of Conformity

*This Declaration of Conformity is only valid when the instrument is used in accordance with this Operator Manual*

**Manufacturer's Name:** Thermo Shandon Limited (Trading as Thermo Fisher Scientific)  
**Manufacturer's Address:** Tudor Road, Manor Park, Runcorn, Cheshire, WA7 1TA  
ENGLAND  
**Product Description:** Electronic Cryostat  
**Product Designation:** **Cryotome® E**

*(0620E, 0620E/G, 0620E/F, 0620E/110)*

*including accessories supplied as standard, and the following accessories:*

*Orientation Heads: 0620-006, 0620-008*

*Cryocassettes: 603, 605, 77210080, 0620-001, 0620-007, 0620-026, 0620-036, 0620-039, 0620-041, 0620-405, 0620-820, A77210155*

*Knife Holders: 0620-021H, 0620-021L, 0620-022H, 0620-022L, 0620-023*

**Year of Marking (CE):** 1996

This product conforms with the essential requirements of the following directives:

In Vitro Diagnostics Directive 98/79/EC

Low Voltage Directive 73/23/EEC *(as amended by 93/68/EEC)*

This product complies with the following International Standards:

**EMC:** EN61326-2-6

EN61000-3-2

EN61000-3-3

**Safety:** IEC 1010-1

CAN / CSA - C22.2 No 1010.1-92

UL Std No. 3101

**Issued by:** K Waldron  
Quality Manager  
Thermo Fisher Scientific  
Clinical Diagnostics, Anatomical Pathology



Date: 8 January 2010

*Optional accessories considered subject to the In Vitro Diagnostic Directive (IVDD) are specifically identified on this Declaration of Conformity. Further supplies of standard accessories are treated as spares. Convenience aids offered as accessories are not subject to the IVDD*

# Declaration of Conformity

*This Declaration of Conformity is only valid when the instrument is used in accordance with this Operator Manual*

**Manufacturer's Name:** Thermo Shandon Limited (Trading as Thermo Fisher Scientific)  
**Manufacturer's Address:** Tudor Road, Manor Park, Runcorn, Cheshire, WA7 1TA  
ENGLAND

**Product Description:** Standard Cryostat

**Product Designation:** **Cryotome<sup>®</sup>**

*(0620E, 0620/G, 0620/F, 0620/110)*

*including accessories supplied as standard, and the following accessories:*

*Orientation Heads: 0620-006, 0620-008*

*Cryocassettes: 603, 605, 77210080, 0620-001, 0620-007, 0620-026, 0620-036, 0620-039, 0620-041, 0620-405, 0620-820, A77210155*

*Knife Holders: 0620-021H, 0620-021L, 0620-022H, 0620-022L, 0620-023*

**Year of Marking (CE):** 1996

This product conforms with the essential requirements of the following directives:

In Vitro Diagnostics Directive 98/79/EC

Low Voltage Directive 73/23/EEC *(as amended by 93/68/EEC)*

This product complies with the following International Standards:

**EMC:** EN61326-2-6

EN61000-3-2

EN61000-3-3

**Safety:** IEC 1010-1

CAN / CSA - C22.2 No 1010.1-92

UL Std No. 3101

**Issued by:** K Waldron  
Quality Manager  
Thermo Fisher Scientific  
Clinical Diagnostics, Anatomical Pathology



Date: 8 January 2010

*Optional accessories considered subject to the In Vitro Diagnostic Directive (IVDD) are specifically identified on this Declaration of Conformity. Further supplies of standard accessories are treated as spares. Convenience aids offered as accessories are not subject to the IVDD*

# APPENDIX A

## TRANSPORTATION INSTRUCTIONS

### A.1 INTRODUCTION

If you ever need to transport the Cryotome, follow these packaging instructions.

### A.2 TO REPACK THE CRYOTOME E



**THE CRYOTOME E WEIGHS APPROXIMATELY 120kg (265lbs). ALWAYS GET HELP TO SAFELY MOVE THE INSTRUMENT WITHOUT RISK OF INJURY**

- 1 Follow the instructions in Chapter 5 and follow good laboratory practice to clean and decontaminate the instrument. Complete and sign the Product Return Safety Declaration (at the end of this chapter) to confirm that the instrument is fully decontaminated.

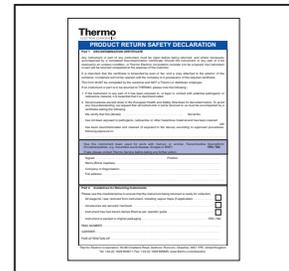

- 2 Make sure that all knives and blades are removed from the instrument.

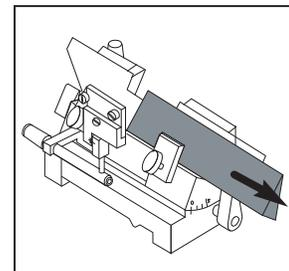

- 3 Use the Advance Control Panel to position the Specimen Head in a central position. Remove mains cables from the rear of the electronics box.

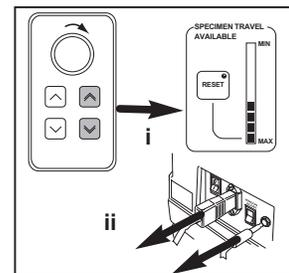

- 4 Remove the Knife Holder.

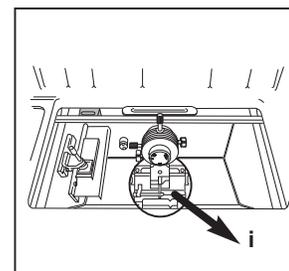

- 5 Empty the waste bottle and replace the empty bottle.



**BE AWARE OF POTENTIAL BIOHAZARDS AND FORMALIN CONTAINED IN THE WASTE BOTTLE. DISPOSE OF CORRECTLY IN ACCORDANCE WITH LOCAL PROCEDURES**

- 6 Lock the handwheel and remove the handwheel bolt.

- 7 Remove the handwheel

- 8 Secure the Cryobar with a rubber band. Lift the top cover and secure the window in the closed position using sticky tape. Turn the instrument lowering knobs counter-clockwise to lower the castors to the ground.

- 9 Remove the back panel.

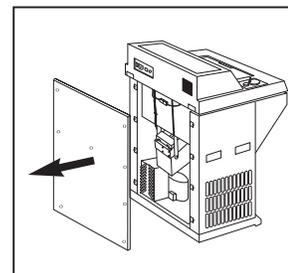
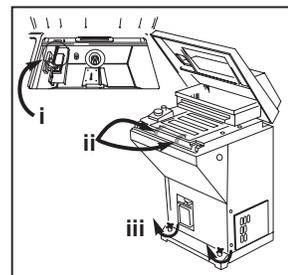
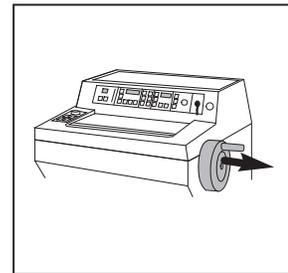
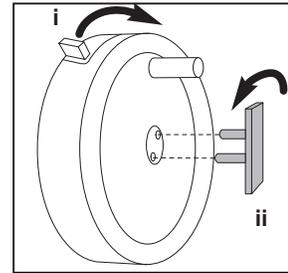
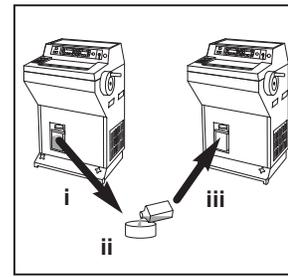

Refit the transit fixings as follows:  
*(the red transit fixings were kept safe when the instrument was installed. To avoid damage to the instrument, the instrument must not be transported without the transit fixings fitted. Contact Thermo if necessary)*

10 Fit the transit plate to the rear of the microtome assembly.

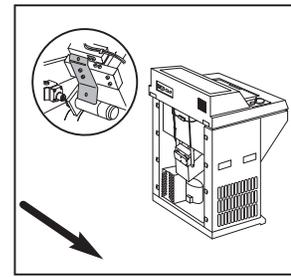

11 Place the spacer between the microtome casting and leadscrew arm (ii). Carefully adjust the leadscrew so that the leadscrew arm rests on the spacer (i). (Note that the leadscrew may need to be manually turned).

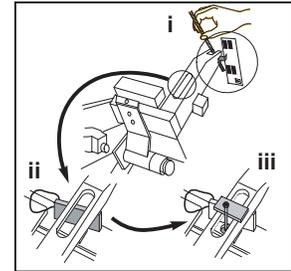

Fit the stud from underneath the leadscrew and secure the top spacer with the 'butterfly' nut.

12 Unscrew and remove the nut on top of the defrost valve. Carefully remove the defrost valve from the copper tube and use cable ties to secure it to the transit plate on the rear of the microtome. Place the nut, washer and nameplate into a small bag and secure to the defrost valve.

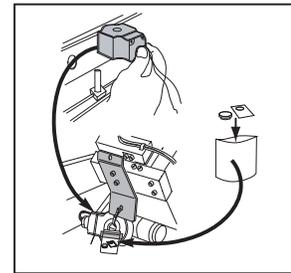

13 Place the wooden supports under the compressor mounting plate.

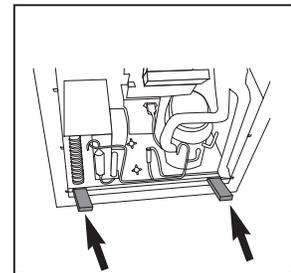

14 Fit and tighten the two red handles to the screws on the base of the compressor mounting plate.

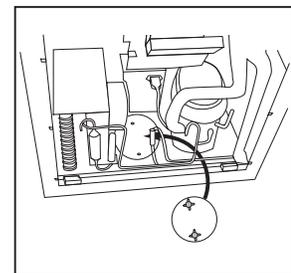

15 Replace the back panel. Make sure the centre bolt is also fitted.

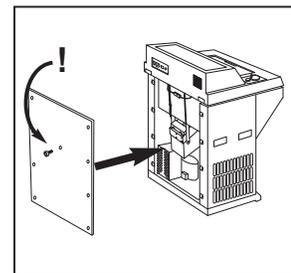

## A.3 TO REPACK THE STANDARD CRYOTOME



**THE STANDARD CRYOTOME WEIGHS APPROXIMATELY 120kg (265lbs). ALWAYS GET HELP TO SAFELY MOVE THE INSTRUMENT WITHOUT RISK OF INJURY**

- 1 Follow the instructions in Chapter 5 and follow good laboratory practice to clean and decontaminate the instrument. Complete and sign the Product Return Safety Declaration (at the end of this chapter) to confirm that the instrument is fully decontaminated.

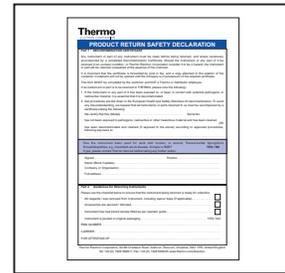

- 2 Make sure that all knives and blades are removed from the instrument.

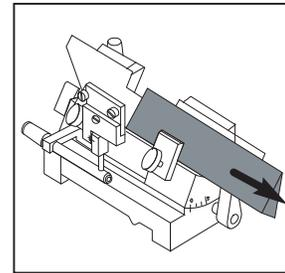

- 3 Remove mains cables from the rear of the electronics box.

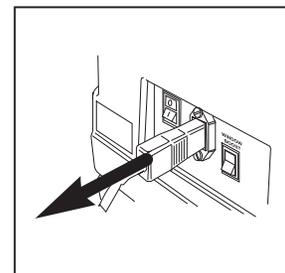

- 4 Remove the Knife Holder.

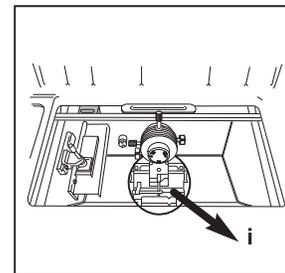

- 5 Empty the waste bottle and replace the empty bottle.

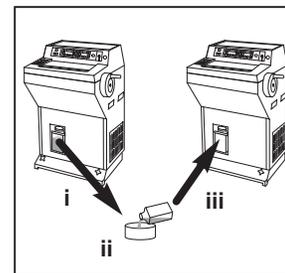

**BE AWARE OF POTENTIAL BIOHAZARDS AND FORMALIN CONTAINED IN THE WASTE BOTTLE. DISPOSE OF CORRECTLY IN ACCORDANCE WITH LOCAL PROCEDURES**

- 6 Lock the handwheel and remove the handwheel bolt.

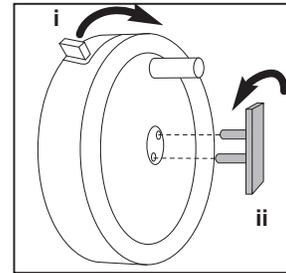

- 7 Remove the handwheel

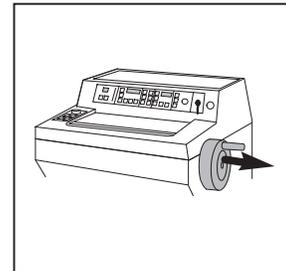

- 8 Use the Advance Panel to move the Specimen Head backwards.

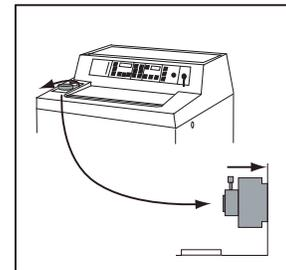

- 9 Secure the Cryobar with a rubber band. Lift the top cover and secure the window in the closed position using sticky tape. Turn the instrument lowering knobs counter-clockwise to lower the castors to the ground.

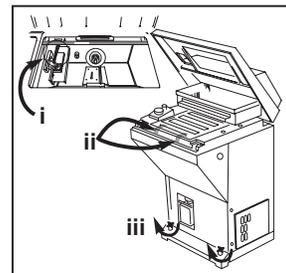

- 10 Remove the back panel.

Refit the transit fixings as follows:  
*(the red transit fixings were kept safe when the instrument was installed. To avoid damage to the instrument, the instrument must not be transported without the transit fixings fitted. Contact Thermo if necessary)*

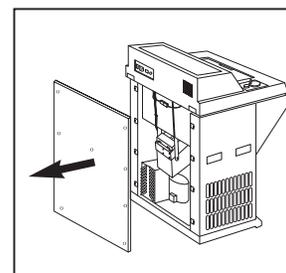

11 Fit the transit plate to the rear of the microtome assembly.

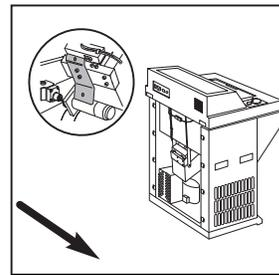

12 Unscrew and remove the nut on top of the defrost valve. Carefully remove the defrost valve from the copper tube and use cable ties to secure it to the transit plate on the rear of the microtome. Place the nut, washer and nameplate into a small bag and secure to the defrost valve.

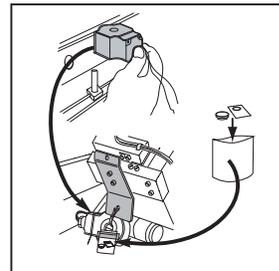

13 Place the wooden supports under the compressor mounting plate.

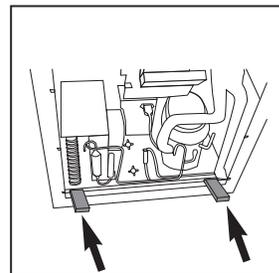

14 Fit and tighten the two red handles to the screws on the base of the compressor mounting plate.

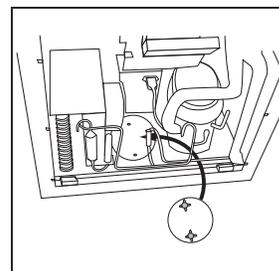

15 Replace the back panel. Make sure the centre bolt is also fitted.

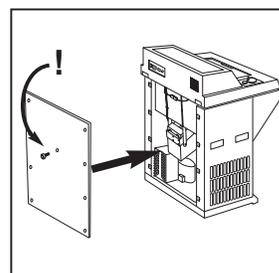

## PRODUCT RETURN SAFETY DECLARATION

### Part 1 DECONTAMINATION CERTIFICATE

Any instrument or part of any instrument must be clean before being returned, and where necessary accompanied by a completed Decontamination Certificate. Should the instrument or any part of it be received in an unclean condition, or Thermo Fisher Scientific consider it to be a hazard, the instrument or part will be returned unrepaired at the expense of the customer.

It is important that the certificate is forwarded by post or fax, and a copy attached to the exterior of the container. Containers will not be opened until the company is in possession of the required certificate.

This form **MUST** be completed by the customer and **NOT** a Thermo or distributor employee.

If an instrument or part is to be returned to THERMO, please note the following:-

- 1 If the instrument or any part of it has been exposed to, or been in contact with potential pathogenic or radioactive material, it is essential that it is decontaminated.
- 2 Set procedures are laid down in the European Health and Safety Directives for decontamination. To avoid any misunderstanding, we request that all instruments or parts returned to us must be accompanied by a certificate stating the following:

We certify that this (Model) ..... Serial No

- has not been exposed to pathogenic, radioactive or other hazardous material and has been cleaned
- OR
- has been decontaminated and cleaned (if exposed to the above) according to approved procedures, following exposure to:  
.....

- Has the instrument been used for work with human, or animal, Transmissible Spongiform Encephalopathies, e.g. Creutzfeld-Jacob disease, Scrapie or BSE? **YES / NO**

If yes, please contact Thermo Service before taking any further action.

Signed ..... Position .....

Name (Block Capitals) .....

Company or Organisation .....

Full address .....

### Part 2 Guidelines for Returning Instruments

Please use the checklist below to ensure that the instrument being returned is ready for collection.

- All reagents / wax removed from instrument, including vapour traps (if applicable) .....
- Accessories are secured / itemised .....
- Instrument has had transit clamps fitted as per operator guide .....
- Instrument is packed in original packaging ..... YES / NO

RMA NUMBER .....

CARRIER .....

FOR ATTENTION OF .....

# APPENDIX B

## APPROVED REAGENT LIST

### B.1 INTRODUCTION

This Section lists all the reagents that Thermo specify can be used with the Cryotome cryostat.

If you want to use a reagent not included in this list, contact your Thermo agent for advice.



**ALWAYS REFER TO THE MATERIAL SAFETY DATA SHEET (MSDS) FOR THE REAGENTS USED**

### B.2 REAGENT LIST

#### B.2.1 Decontaminants:

Formalin 10%  
Sodium Hypochlorite 10%

### B.3 CLEANING AGENTS

Dilute detergent  
Alcohol  
Water

# APPENDIX C

## EXAMPLES

### C.1 INTRODUCTION

This section provides a guideline cutting temperatures for the Thermo Cryotome.

### C.2 SUGGESTED CUTTING TEMPERATURES FOR FROZEN TISSUES



**BE AWARE THAT TISSUE SAMPLES MAY POSE A BIOHAZARD. TAKE SUITABLE PRECAUTIONS**

TISSUE TYPE	CHAMBER TEMPERATURE (°C)
<i>UNFIXED TISSUE</i>	
Brain	-12
Liver	-14
Lymph Node	-14
Kidney	-16
Spleen	-16
Muscle	-20
Thyroid	-20
Skin	-25
Breast	-25
Breast with fat	-30 or below
Adipose tissue	-30 or below
<i>FIXED TISSUE</i>	
Fixed tissue	-12 to -17

\* *These temperatures are guidelines only. Make sure that the tissue is sufficiently frozen before sectioning.*

# INDEX

## Symbols

--- Message Code 16

 BioHazard symbol 2

 Harmful chemical symbol 2

 Temperature symbol 1 2

 Warning symbol 2

 Warning Symbol 2

## A

Ald Message Code 16

### APPENDIX A - TRANSPORTATION INSTRUCTIONS 60

Introduction 60

Product Return Safety Declaration 66

To Repack the Instrument 60, 63

### APPENDIX B - APPROVED REAGENT LIST 67

Cleaning Agents 67

Introduction 67

Reagent List 67

### APPENDIX C - EXAMPLES 68

Introduction 68

Suggested Cutting Temperatures for Frozen  
Tissues 68

## C

Centre of Gravity Position 5, 55

### CLEANING AND MAINTENANCE 43

Cleaning 45

To Clean the Knife 46

Defrosting 46

Electrical Protection 48

Flash Testing 49

Portable Appliance Testing (PAT) 49

Fumigation 44

General 43

Maintenance 47

To Fit a Lamp Tube 48

To Remove the Lamp Tube 47

## CONTENTS 3

## CONTROLS 8

Advance Control Panel 15

Cryotome E 15

Standard Cryotome 15

Connections 18

Mains On/Off Circuit Breaker 18

Power Inlet 18

Window Boost 18

Description 8

Main Control Panel 8

Chamber Controls 11

**[CANCEL DEFROST/FUMIGATE]** 13

**[CRYOBAR BOOST]** 13

**[IMMED DEFROST]** 11

**[IMMED FUMIGATE]** 12

**[LAMP]** 13

**[WINDOW LOCK]** 13

Keyswitch Control 14

Micron Selector 8

Specimen Travel 9

Temperature Controls 14

Time Controls 9

To Set Defrost Times 10

To Set Fumigate Times 11

To Set the Clock 10

Message Codes 16

--- 16

**Ald** 16

**dEF** 16

**Err 1** 17

**Err 2** 17

**Err 4** 17

Fault Codes 16

**LOBAT** 16

**P FAIL** 17

**P SAVE** 17

**rESet** 17

## D

Decontamination Warnings 5, 43

**dEF** Message Code 16

DESCRIPTION 7

Cryotome SME Annotated Diagram 7

Cryotome SME Overview 7

## E

Electrical Earthing Requirements 5, 26

Electrical Specification 54

Environmental Specifications 55

Error Codes 17–18

## F

Fault Codes 16

Flash Testing 49

Fuse Details 54

## I

INSTALLATION AND SETTING UP 19

Electrical Requirements 25

Introduction 19

To Install the Cryotome 22

To prepare the instrument for use 27

Specimen Head 35

Coarse Orientation Head 37

Fine Orientation Head 36

Fixed Orientation Head 35

To Change Orientation Heads 37

To Fit a Disposable Blade 33

To Fit a Knife Holder 29

To Fit a Standard Solid Knife 30

To Set Up the Knife Holder and Anti-Roll  
Plate for Disposable Blades 34

To Set Up the Knife Holder and Anti-Roll  
Plate for Standard Solid Knives 31

Warnings 27

To Remove the Transit Fixings 20

Microtome Transit Fixings 22

Refrigeration Transit Fixings 21

To Switch On and Off 26

To Switch Off 27

To Switch On 26

To Unpack 19

## L

**LOBAT** Message Code 16

## M

Mains On/Off Circuit Breaker 18

Microtome Specification 55

## O

On/Off Switch convention 54

OPERATION 38

Housekeeping 42

Introduction 38

Mounting a Specimen 38

To Cut Sections 41

To Remove the Specimen from the  
Cryocassette 42

To Set the Knife Holder for Cutting Specimen 40

## P

Physical Specification 54

Portable Appliance Testing (PAT) 49

Power Demand Characteristics 54

Power Inlet 18

PRODUCT RETURN SAFETY DECLARATION 66

**P FAIL** Message Code 17

**P SAVE** Message Code 17

## R

Refrigeration System Information 6

**rRESEt** Message Code 17

## S

Safety notices 4

SPECIFICATION AND ACCESSORIES 54

Accessories 56

Spares 56

Specification 54

Centre of Gravity Position 55

- Electrical 54
- Environment 55
- Fuses 54
- Microtome 55
- Physical 54
- Power Demand Characteristics 54
- Switch Convention 54
- Thermo Part Numbers 55

Statement of intended use 4

## **T**

TRANSIT FIXINGS 20

- Microtome Transit Fixings 22
- Refrigeration Transit Fixings 21

TROUBLE SHOOTING 50

- General 50
- Table 1 - Instrument Function 50
- Table 2 - Problems when sectioning 51–52
- Table 3 - Error Messages 53

## **W**

WARRANTY STATEMENT 57

Waste Bottle 27, 47

Weight 5, 19

WELCOME 4

- Introduction 4
  - Statement of intended use 4
- Safety 4
  - Centre of Gravity Position 5
  - Electrical Earthing Requirements 5
  - Refrigeration information 6
  - Warnings 4–6

Window Boost 18

