

SERVICE MANUAL

**Dynatron® 950plus &
Dynatron® 650plus**

CAUTION: Federal law restricts this device to sale by or on the order of a physician, chiropractor, physical therapist, or dentist licensed by the law of the state in which said person practices to use or order the use of the device.

IMPORTANT: Before treating a patient with the Dynatron 950plus or the Dynatron 650plus, see the “Contraindications, Warnings, and Precautions” in this manual.

INDICATIONS FOR USE:

Muscle stimulation therapy delivered by the Dynatron 950plus and 650plus is indicated for the following uses:

1. relaxation of muscle spasm;
2. prevention or retardation of disuse atrophy;
3. increasing local blood circulation;
4. muscle re-education;
5. immediate post surgical stimulation of calf muscles to prevent venous thrombosis; and
6. maintaining or increasing range of motion.

Interferential, premodulated, high volt and microcurrent therapy are indicated for providing temporary relief of chronic intractable pain.

INDICATIONS FOR ULTRASOUND USE:

Ultrasound therapy is intended to generate deep heat within body tissues for the treatment of selected medical conditions such as relief of pain, muscle spasms, and joint contractures, but not for the treatment of malignancies.

(21 CFR 890.5300)

Dynatron® 950plus and Dynatron® 650plus Service Manual

Revised June 2004

© Copyright 1997

Dynatronics Corporation

7030 Park Centre Drive

Salt Lake City, UT 84121

(801) 568-7000 (800) 874-6251

ALL RIGHTS RESERVED

Table of Contents

Section I Introduction

Introduction to the Dynatron 950plus™ and 650plus™	2
New Features	2
Treatment Options	3
Simplified Setup	4
Before You Treat a Patient	4
How to Use This Manual	4
Installation and Features.....	5
Unpacking	5
Standard Accessories.....	5
Soundheads and Probes	6
Accessories	6
Dynatron 950plus and Dynatron 650plus Physical Features.....	7
General Selections:	7
IFC / Premod Selections:	9
Ultrasound Selections	10
Russian / Biphasic / High Volt Selections:	11
Microcurrent Selections:.....	11
Dynatron 950plus and 650plus Back Panel:	12
Dynatron 950plus and 650plus Side Panels:.....	13
Instructions for Using Toggle Keys	13
Time and Power Displays.....	14
Ultrasound Heads (Dynatron 950plus only).....	15
Microcurrent Probes (optional accessory).....	16
High Volt Probe (optional accessory)	17
Quick Reference of Special Key Presses	18

Section II Operation and Treatment Instructions

General Operating Instructions.....	20
Power On/Off	20
Basic Treatment Setup.....	20

Conductance Bar Graph	21
“LEAD” Warning - No Patient Current	22
Interferential / Premodulated Instructions	24
Basic Interferential / Premod Setup	24
Detailed Interferential / Premodulated Setup.....	25
Interferential / Premodulated Default Settings.....	28
Biphasic / Russian Instructions	29
Basic Biphasic / Russian Setup	30
Detailed Biphasic / Russian Setup	30
Biphasic / Russian Default Settings	34
High Volt Instructions.....	35
Set Up High Volt Treatment with Electrodes	35
Set Up High Volt Treatment with Optional Probe.....	36
Basic High Volt Setup	37
Detailed High Volt Setup.....	37
High Volt Default Settings.....	41
Microcurrent Instructions	42
Basic Microcurrent Setup	42
Microcurrent Treatment Time.....	43
Detailed Microcurrent Setup	43
Audio Tone	46
Microcurrent Default Settings.....	46
How To Use Microcurrent Probes	46
Ultrasound Instructions	48
Soundhead Warming.....	48
Turn Soundhead Warming Off / On	49
Basic Ultrasound Setup.....	49
Detailed Ultrasound Setup	49
Ultrasound Default Settings	51
Patient Coupling	51
Poor Coupling	52
Ultrasound Coupling Bar Graph	52
Head Temperature Hot.....	53
Head Temperature Bar Graph	54
Display Watts or W/cm ²	54
Combination Therapy Instructions	56

Comboplus™.....	56
Stim Through the Soundhead.....	57
Combination Therapy Setup.....	58
Modify Treatment.....	60
Combination Default Settings.....	61
Simultaneous Treatments.....	62
Set Up A Second Treatment.....	62
Modify Simultaneous Treatments.....	63
Stop One Treatment.....	63
Setting Defaults.....	64
Save New Defaults.....	64
Example:.....	64
Restore Factory Defaults.....	65
Interferential Default Settings.....	65
Premodulated Default Settings.....	65
Russian / Biphasic Default Settings.....	65
High Volt Default Settings.....	66
Microcurrent Default Settings.....	66
Ultrasound Default Settings.....	66
Combination Default Settings.....	66
Battery Operation.....	67
Battery Requirements.....	68
Battery Life.....	68

Section III
General Modality Information

Interferential and Premodulated Therapy.....	70
Interferential (Quadpolar) Therapy.....	70
Premodulated (Bipolar) Therapy.....	70
Target.....	71
Why Is Target Better?.....	71
Sweep.....	72
Interferential Electrode Placement.....	72
Russian / Biphasic Therapy.....	73
Russian Stimulation.....	73
Biphasic Stimulation.....	73
Biphasic / Russian Parameters.....	73

High Volt Therapy.....76
 High Volt Therapy with Electrodes76
 High Volt with Optional Probes76
 High Volt Waveform76
 High Volt Settings.....76

Microcurrent Therapy78
 Microcurrent Therapy with Electrodes78
 Microcurrent Therapy with Probes78
 Microcurrent Waveforms78
 Microcurrent Settings.....78

Ultrasound Therapy79
 About Ultrasound.....79
 SmartHeads79
 Patient Coupling79
 Soundhead Temperature80

**Section IV
Contraindications, Warnings, and Precautions**

Contraindications, Warnings, & Precautions for Interferential, Premodulated, Russian, Biphasic, and High Voltage Pulsed Stimulation82
 Contraindications82
 Warnings82
 Precautions.....83
 Treatment Setup Warnings83
 Adverse Effects84
 Use Only Dynatronics Accessories With This Device84

Contraindications, Warnings, & Precautions for Microcurrent Treatment.....85
 Indications for Use85
 Contraindications85
 Warnings85
 Precautions.....86
 Adverse Reactions86

Contraindications, Warnings, & Precautions for Ultrasound Treatment87
 Contraindications87
 Precautions.....88
 Warnings88

Electrotherapy Usage Cautions 89
Carbon Electrodes 90
Self-Adhesive Electrodes 91
Combination Treatment Usage Cautions..... 92
Lead Wires 92
Test Leads..... 93
Current Limit 93
Current Limit Warning 93

Microcurrent Usage Cautions..... 95

Ultrasound Usage Cautions..... 96
Applicator Movement..... 96
Patient Susceptibility 96
Potential for Burns..... 96
Output Power..... 97
Penetration of Ultrasound Waves 97
Coupling 97

Section V
Ultrasound Technical Information

Ultrasound Regulation..... 100

Beam Profile 101

Enter Soundhead Parameters 104
New SmartHeads™ 104
Using Older Model Soundheads With the 50 Series Plus 104

Calibration Procedure 106

Problem Solving 108
Soundhead Temperature Too Hot 108
Cooling the Soundhead 109
Whirlpool Treatments..... 109
Soundhead Temperature Too Cold..... 109
No Soundhead 110
Other Error Messages in the Display..... 110

**Section VI
Technical Information**

General Specifications.....112

- Dynatron 950plus and 650plus Specifications..... 112
- Stim Specifications 112
- Microcurrent Specifications.....112
- High Volt Specifications.....113
- Ultrasound Specifications (Dynatron 950plus only)..... 113
- Environmental Conditions113
- Safety Features of the Dynatron 950plus and 650plus113
- Care and Cleaning Instructions.....114
- Suggested Maintenance Schedule.....114
- Routine Ultrasound Calibration Inspections (Dynatron 950plus only).....115
- Software Updates115
- Returning a Unit for Repair116
- Definition of Symbols.....117
- Equipment Classification117
- Disposal of Equipment and Accessories.....117
- Additional Technical Information Available (for Technicians Only).....117
- Dynatronics Electrodes and Lead Wires.....118

Medical Device Reporting Requirements.....119

- Reporting any Incident of Patient Discomfort119

**Section VII
Service**

Processor Interaction122

- Processor Interaction with the Keyboard and Displays122
- Processor Interaction with Oscillators122
- Processor Interaction with the Output Jacks.....122
- Processor Control of Output Waveforms.....122

Basic Trouble Shooting Techniques.....123

- Hands-On Testing Pads and Leads123

Installing Software Updates.....124

Installing Replacement Parts.....124

**Section VIII
Schematics and QC Check Lists**

Section I

Introduction

Introduction to the Dynatron 950plus™ and 650plus™

The Dynatron 950plus and Dynatron 650plus offer the practitioner a wide range of treatment options in a single device. Both devices provide interferential and premodulated therapy, high voltage pulsed stimulation, Russian and biphasic stimulation, and microcurrent. The 950plus also includes ultrasound and combination therapy.

The devices include the advantages of earlier Dynatronics models, such as customizable treatments with convenient setup. In addition, these units are smaller and lighter in weight than earlier models and now offer the option of battery operation, making the devices truly portable. Two additional channels are now dedicated to high volt therapy, allowing a greater variety of simultaneous treatments. The manufacturer's warranty for these devices is now two years (see full warranty details at the back of this manual).

This manual provides operator information and instructions for both of these models. The sections that discuss ultrasound and combination treatments apply only to the Dynatron 950plus model. All other sections of this manual apply to both devices. Sections of this manual that apply only to the Dynatron 950plus are clearly marked.

New Features

For models having software greater than Rev. 1.01 or later, the following new features have been added (effective January 1998).

- Conductance Bar Graph. A graphical representation of conductivity during an interferential, premodulated, or microcurrent treatment.
- Ultrasound Coupling Bar Graph. Shows soundhead coupling during an ultrasound treatment.
- Soundhead Temperature Bar Graph. Indicates when soundhead temperature is too hot during a treatment.
- "Lead" warning. A new warning displayed if the device detects an open circuit, indicating no patient current is being delivered and the treatment setup must be inspected.
- New warnings notifying the user when the soundhead is too hot, or when the soundhead is not detected by the device

These new features are described in greater detail in the treatment instructions later in this manual. To determine the software revision level for the Dynatron device, power the device ON and observe the number shown in the Time display at the end of the device's startup routine.

Treatment Options

The following modalities are provided by both the Dynatron 950plus and the Dynatron 650plus:

Interferential Therapy: This traditional therapy, delivered with two channels and four electrodes, also includes Dynatronics' patented Target feature for easy location of the treatment site and delivery of the full interferential beat where it is needed. You can select the high frequency range, the low frequency range, or both, along with Target. Or select Sweep when you want to deliver the current over a more general area. You can also customize the frequency settings for individual treatments or save a unique default setting.

Premodulated Therapy: Ideal for treating areas where four electrode-placements is not practical, this modality extends the versatility of the device by offering a premodulated interferential current using one channel and two electrodes.

Biphasic Stimulation: This option provides muscle stimulation using a sinusoidal biphasic waveform with pulse widths, ranging from 50 to 400 microseconds. It offers normal, co-contraction and reciprocal contraction modes, selectable on/off cycle times and ramp times, and customizable pulse rate and pulse width.

Russian Stimulation: With this modality, you can deliver muscle stimulation treatments selecting from an array of options including normal, co-contraction and reciprocal contraction, selectable on/off cycle times and ramp times, and customizable pulse rate and pulse width.

High Voltage Pulsed Stimulation: This traditional electrotherapy modality offers a pulsed, monopolar current with pulse widths in the microsecond range and pulse rates ranging from 1 to 200 Hz utilizing a twin-peak monophasic waveform. Polarity, on/off cycle time, and ramp time are selectable, and pulse rate may be customized for each treatment. Treatment may be delivered using either electrodes or optional probes.

Microcurrent Therapy: Microcurrent treatment may be delivered using two electrodes for unattended therapy, or the optional hand-held probes for manual treatment. You may select the desired polarity and customize the frequency and intensity. An audible tone allows you to monitor conductance.

The following additional modalities are provided with the Dynatron 950plus (not included with the Dynatron 650plus):

Ultrasound Therapy: The Dynatron 950plus includes Dynatronics' patented multi-frequency ultrasound capability. Soundheads are available in 1 cm², 2 cm², 5 cm², and 10 cm² sizes. Each soundhead offers 1, 2, and 3 MHz. (The 1 cm² soundhead offers 2 and 3 MHz.) Duty cycle options are 10, 20, and 50 percent, or a continuous duty cycle.

Combination Therapy - Comboplus™: Dynatronics' new Comboplus feature gives you almost unlimited options in setting up a combination treatment with the Dynatron 950plus. Now you can combine an ultrasound treatment with any single-channel electrotherapy modality provided by this device, including Premodulated, Biphasic, Russian, High Volt, or Microcurrent. In addition, combination therapy is

no longer restricted to just one channel—any channel may be used. This means you may set up a combination treatment using any of the six electrotherapy output jacks. Combination therapy offers simultaneous treatment time and allows you to select from all the available options for both modalities used in the combined treatment.

Simplified Setup

The unique design of the Dynatron 950plus and 650plus front panels means treatment setup has never been easier. A few simple key presses are all you need to fully set up a treatment. The careful grouping of available options for each modality ensures that you can easily see and select from the appropriate options for that modality.

Each modality offers default settings which are automatically selected when the modality is selected—saving time in the treatment setup. You can change these defaults to match your own most common treatment setups to reduce setup time to a matter of seconds.

Before You Treat a Patient

Before administering a treatment to a patient with the Dynatron 950plus or 650plus, you should familiarize yourself with all the operating instructions for the modality used, as well as the contraindications, warnings, and precautions for that modality.

You should also read in this manual general information about each of the modalities. In addition to the information provided in this manual, consult other published sources for additional application and safety instructions regarding use of each type of therapy.

How to Use This Manual

This manual is organized to help you learn how to use your Dynatron 950plus and 650plus device, and to provide easy reference for looking up specific instructions or information. The information in the manual is grouped as listed below. Note that all treatment instructions for all modalities are in one section, and that all contraindications, warnings, and precautions for all modalities are provided together in another section.

This grouping of information makes it easy for you to find what you are looking for. To assist you further, descriptive titles appear at the foot of each page to help to identify immediately what section you are in. Familiarize yourself with the organization and presentation of this manual to make best use of the information provided.

- Section I: Introduction, Installation and Features**
- Section II: Operation and Treatment Instructions**
- Section III: General Modality Information**
- Section IV: Contraindications, Warnings, and Precautions**
- Section V: Ultrasound Technical Information**
- Section VI: General Technical Information**
- Section VII: Patient Information**

Installation and Features

Unpacking

When you receive the unit, immediately unpack it and all accessories and check for possible damage, obvious or concealed. In case of damage, immediately notify the carrier and take any steps necessary to file a claim for the damage sustained. Do not destroy the shipping carton. The carton should be reused if the device must be shipped for any reason. The carton is specially designed to protect the unit from shipping damage. Improper packaging of the unit during transport can result in damage and invalidate the warranty.

Complete the warranty registration form and return it to Dynatronics within 10 days of purchase. This is essential to insure you are not billed for services that are covered by the warranty policy. Warranty registration should include serial numbers for both the device and soundheads.

Connect the AC power cord, which is equipped with a hospital grade, UL listed plug, to a properly grounded 110/120V 60 Hz AC outlet (the device will automatically switch to 220/240V 50 Hz when connected to a power source with that voltage). The power cord must also be firmly plugged into the device itself. When the cord is properly connected, it can not be easily pulled out. Do not place the cord or the device in a place where the cord could be tripped over or accidentally pulled out of its socket during a treatment.

Read the operating instructions in this manual before proceeding with a treatment.

Standard Accessories

The following accessories are included with the Dynatron 950plus or 650plus units:

Qty	Part No.	Description
1	D951/ D651	Dynatron® 950plus or Dynatron® 650plus unit
1	9B0031	Power Cord
1	8A0061	Patient Remote Stop Cable
1	8J0005	Operator's manual
4	7B0233/ 7B0232	120" double leads (2 red, 2 black)
1	7B0234	Special lead wire for combination treatments (with Dynatron 950plus only)
1	7B0204	POLYST™ self-adhesive electrodes 1.75" x 3.75" w/pin connector (pkg. of 4)
4	7B0063/ 7B0065	3" round carbon electrodes (2 red, 2 gray)
4	7B0191	Sponge fabric for use with 3" carbon electrodes
4	7B0208/ 7B0209	2" round carbon electrodes (2 red, 2 gray)
4	7B0211	Sponge fabric for use with 2" carbon electrodes
4	DW248	2" x 48" straps
1	7B0191	5" x 8" dispersive electrode for high volt w/ sponge fabric
1	7B0202	Applications manual
1	7B0217	Ultrasound gel sample (with Dynatron 950plus only)

Soundheads and Probes

The Dynatron 950plus may be purchased with one or more applicator soundheads in the following sizes:

Part No.	Size	Frequencies
SH01CM	1 cm ²	Operates at 2 and 3 MHz
CM02SH	2 cm ²	Operates at 1, 2, and 3 MHz
CM05SH	5 cm ²	Operates at 1, 2, and 3 MHz
CM10SH	10 cm ²	Operates at 1, 2, and 3 MHz

An optional high volt probe or microcurrent probe may also be purchased for use with this device. Contact your Dynatronics dealer to order optional accessories

Accessories

The following optional and replacement accessories may be purchased from Dynatronics or from your Dynatronics dealer:

Part No.	Description
8E0026	High volt probe (requires one or more applicators)
8E0017	High volt applicator 2" round
8E0018	High volt applicator 5/8" round
8E0019	High volt applicator 2"x1-1/2"
8D0007	Microcurrent active probe
8D0027	Microcurrent ground probe
7B0208/ 7B0209	2" diameter carbon electrodes (red and gray)
7B0063/ 7B0065	3" diameter carbon electrodes (red and gray)
7B0059/ 7B0061	3" x 5" carbon electrodes (red and gray)
7B0067/ 7B0069	1.5" x 2.0" carbon electrodes (red and gray)
7B0003/ 7B0203	1.75" x 3.75" adhesive electrodes (with snap or pin connector)
7B0005/ 7B0204	1.75" square adhesive electrodes (with snap or pin connector)
7B0205	1.25 round adhesive electrodes (with pin connector)
7B0206	2" round adhesive electrodes (with pin connector)
7B0207	3" round adhesive electrodes (with pin connector)
7B0073	72" lead (black)
7B0071	72" lead (red)
7B0077	Bifurcated extension lead wire
7B0081	Banana-to-pin adapter
7B0001	Snap adapter
7B0161/ 5LTRGEL	Ultrasound coupling gel (8 oz. bottle or 5 liter container)

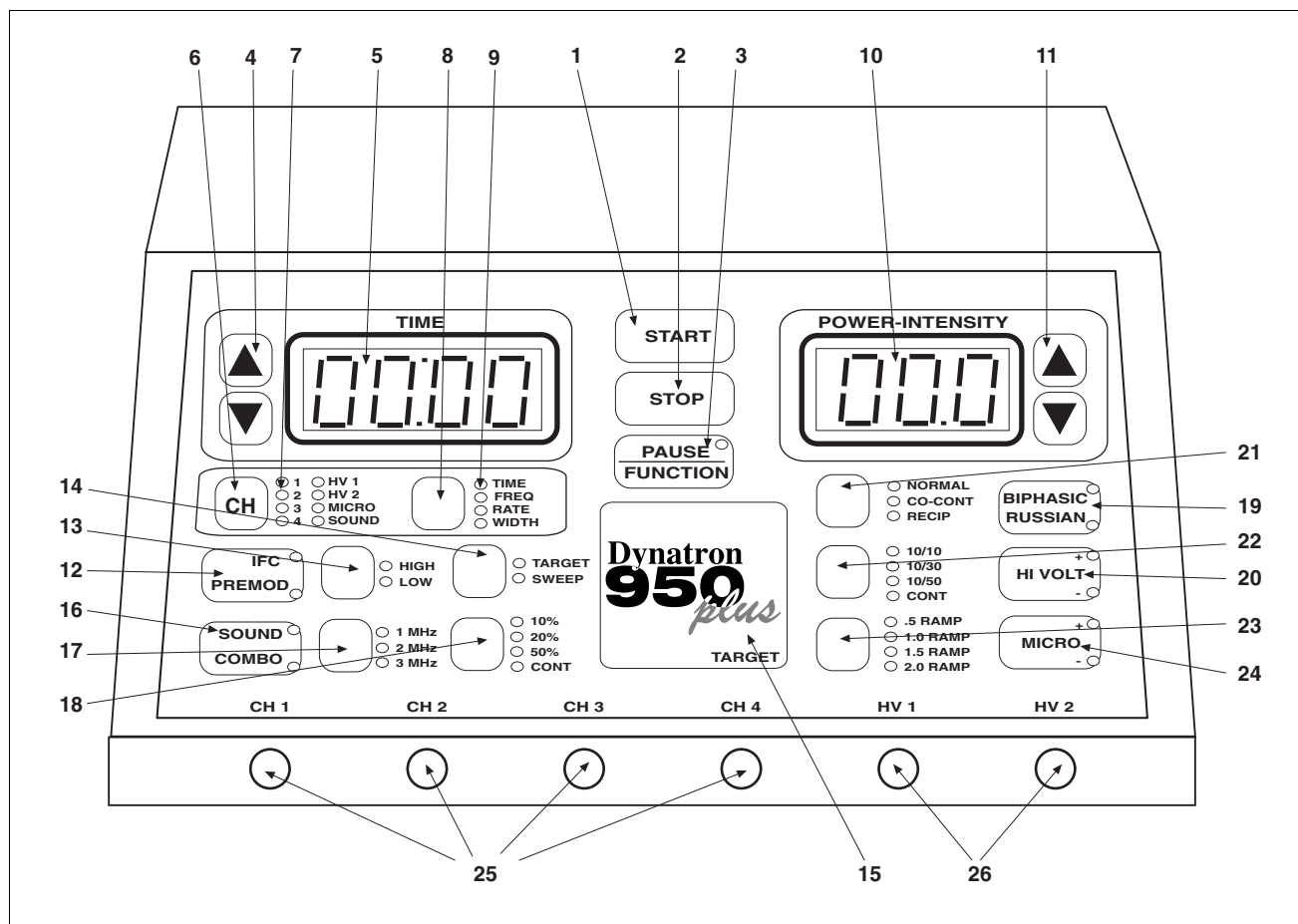

Dynatron 950plus Control Panel

Dynatron 950plus and Dynatron 650plus Physical Features

Before operating the Dynatron 950plus or Dynatron 650plus, acquaint yourself with the control panel by reviewing the illustrations and descriptions on this and the following pages. The numbered features in the diagrams correspond to the numbered descriptions. Before administering treatment to a patient, read the sections later in this manual that provide specific instructions for performing treatments, discussions of each modality, definitions of the available options, along with contraindications, warnings, and precautions for all modalities.

Note that some options use “toggle” keys for making selections. More specific instructions for using toggle keys are provided later in this section.

General Selections:

1. **START:** Pressing this key starts the treatment timer, and treatment proceeds as set up.
2. **STOP:** Pressing this key during a treatment **IMMEDIATELY** stops the output and sets the treatment time to zero for all modalities. Treatments may also be stopped by pressing the button on the patient **REMOTE STOP** cable. You can also stop a treatment for one treatment only by pressing and holding the Function key while you press the Stop key, or by reducing that channel’s treatment time to zero.

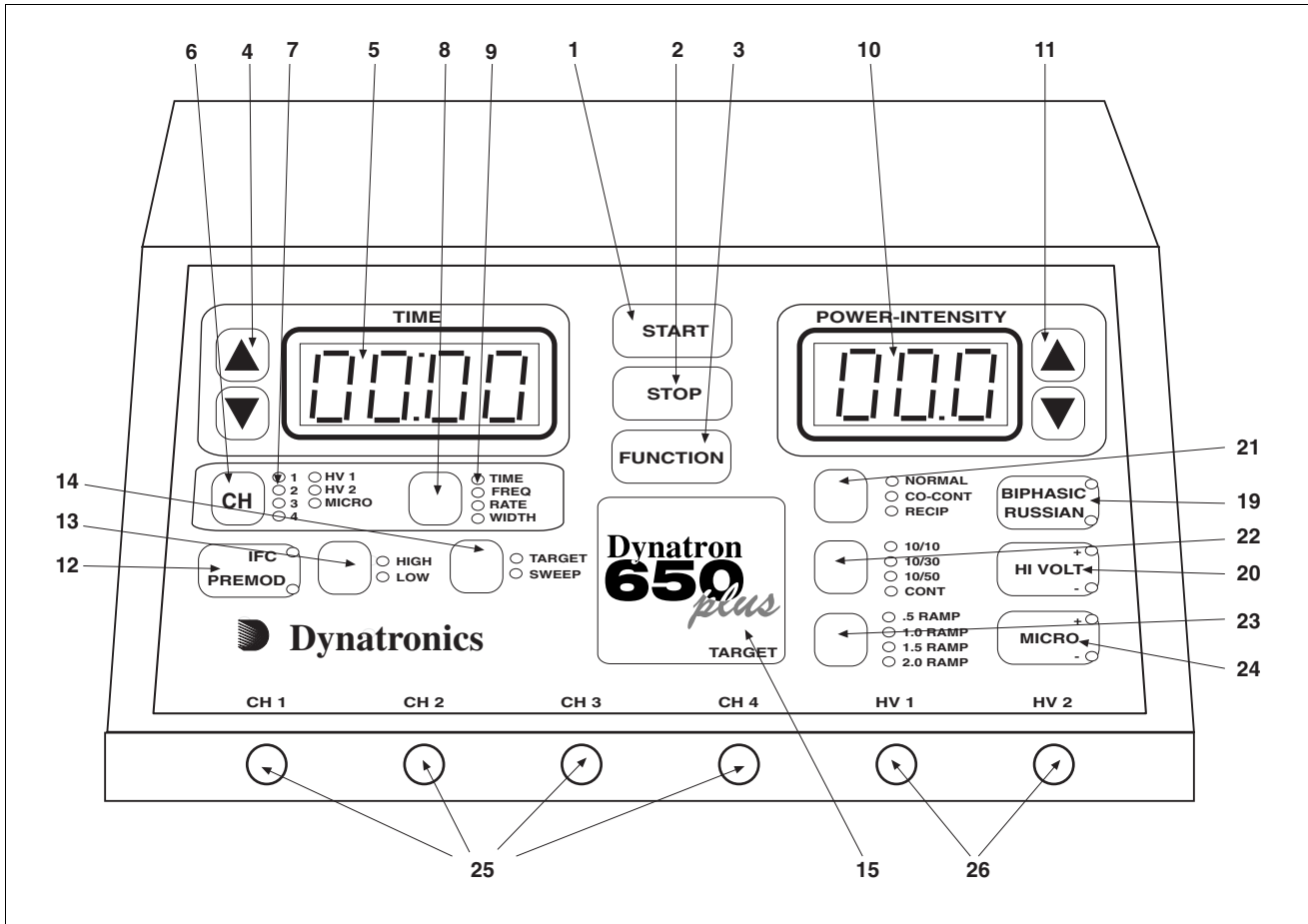

Dynatron 650plus Control Panel

3. **PAUSE/FUNCTION:** This key is used in combination with other key presses for accessing unique features including: select polarity (high volt and microcurrent), audio volume control (microcurrent), and to stop one treatment only. Specific instructions for using this key are provided later in this manual.

For Dynatron 950plus only: This key is also used to pause an ultrasound treatment. First press the channel toggle (CH) to select SOUND, then press PAUSE/FUNCTION; the ultrasound output is stopped, the treatment time is paused, and the light on the Pause key is on. When this key is pressed again, the ultrasound treatment resumes and the light on the Pause key is off. The PAUSE option is not available with the Dynatron 650plus since that model does not offer ultrasound. NOTE: During a Combo treatment, only the ultrasound output and the treatment timer are stopped when you press Pause; the stim output continues.

4. **TIME ARROW KEYS:** These UP/DOWN arrow keys are used to increase/decrease the treatment time or other parameter that is displayed in the Time display.
5. **TIME DISPLAY:** This display is used to show the treatment time for one treatment at a time; the display shows treatment time for the selected channel (the selected channel is indicated by the green LED—all other channels in use at the time will have yellow LEDs). The Time display can also display the pulse rate and width for Russian and biphasic treatments, as well as the frequencies for interferential, premodulated, and microcurrent treatments, and pulse rate for high volt. The treatment parameters for any

treatment in progress may be displayed at any time by first using the channel toggle key to choose the desired channel then using the Time toggle key to select the desired parameter (Time, Freq, Rate, Width).

6. **CHANNEL TOGGLE KEY (CH):** When a treatment is in progress, you can press this key to choose an output channel and display the parameters for the treatment being delivered by that channel. When an output light is GREEN, the displays show the settings for that output. The available options depend on the modality selected. When two or more treatments are in progress simultaneously, the toggle key is used to select the output or channel you wish to view.
7. **CHANNEL SELECTIONS:** These lights indicate which output channels are currently in use. A solid GREEN light indicates current is being delivered to that channel; the time, intensity and other treatment parameters for that channel are also displayed. A solid YELLOW light indicates a channel is in use and delivering current, but the time, intensity, and treatment parameters are not displayed at this time (only one channel's time and intensity may be displayed at a time). Flashing green or flashing yellow indicates the "off" segment of a biphasic or high volt treatment cycle. The channel's intensity and other treatment parameters may only be modified when it has a green indicator light. Press the Channel Toggle key (CH) to select a channel to be viewed.
8. **TIME TOGGLE KEY:** Press this key to display various treatment parameters in the Time display including Time (treatment time), Freq (frequency), Rate (pulse rate), and Width (pulse width). Available options during a given treatment or treatment setup depend on the modality selected.
9. **TIME GROUP SELECTIONS:** These lights indicate the parameters that are displayed (one at a time) in the Time display. The default selection is the treatment time. Press the Time toggle key to select the desired option (available options depend on the modality selected). When a parameter is selected, its indicator light is green, its value is displayed in the Time display above, and the time arrow keys may be used to change the value. The device returns to the Time display after 10 seconds with no key presses.
10. **POWER-INTENSITY DISPLAY:** This display is used to display the treatment power (for ultrasound) or intensity (for all other modalities) for the currently selected channel (the selected channel is indicated by the green LED—all other channels in use at the time will have yellow LEDs). Press the channel toggle key to select the desired channel to be viewed.
11. **POWER - INTENSITY ARROW KEYS:** The arrow keys are used to increase/decrease the intensity or power of one treatment. Changes made to power and intensity affect only the currently selected channel (the selected channel is indicated by the green LED—all other channels in use at the time will have yellow LEDs). Press the channel toggle key to select the desired output channel. The arrow keys may then be used to change the intensity or power for that channel.

IFC / Premod Selections:

12. **IFC/PREMOD:** Press this key once to begin setup of an interferential treatment (the IFC LED is lighted); press this key twice to begin setup of a premodulated treatment (the Premod LED is lighted). When you select IFC, a channel pair (CH1-2 or CH3-4) is automatically selected and the green LED lights for those two channels will be on. Connect two leads to the output jacks for the channels that are selected. When you select

PREMOD, a single channel (1, 2, 3, or 4) is automatically selected and that channel's green LED will be on. Connect one lead to the output jack that corresponds to the channel indicated by the green LED.

13. HIGH/LOW TOGGLE (used with interferential, premodulated and high volt): Press this key one or more times to select the desired frequency range for interferential and premodulated treatments or the pulse rate range for high volt treatments. The green LED indicates the option selected. For example, press the High/Low toggle key once to select High, press again to select Low, press again to select High/Low Alternating, and press again to select High/Low Consecutive. For high volt treatments, you can select High or Low only, but not both. During a treatment, the current sweeps through the range(s) selected.

For interferential and premodulated, the HIGH frequency range is initially set at 80 to 150 Hz; and the LOW frequency range is 0 to 10 Hz. For high volt, the HIGH pulse rate range is initially set at 80 to 120 Hz; and the LOW pulse rate range is 1 to 10 Hz. These frequency ranges may be modified for every treatment, if desired and new default settings for the device may also be saved. See treatment setup instructions later in this manual for a complete description of the options that may be selected.

14. TARGET/SWEEP TOGGLE: This key is pressed to select either Target, Target Sweep, or static treatment for an interferential treatment. The Target pad is used to locate the exact treatment site (if the Target option is selected during an interferential treatment).
15. TARGET PAD: For use during interferential treatments when "Target" is selected. Touch the TARGET pad at different points on the pad to reach the precise treatment site. When you lift your finger from the Target pad, the selected point is locked until you change it again. This patented feature is used to locate the specific treatment site in an interferential treatment and to place the point of interference at that point.

Ultrasound Selections (DYNATRON 950plus ONLY—the ultrasound feature is not available on the Dynatron 650plus):

16. SOUND/COMBO: Press this key once to begin setup of an ultrasound treatment (the Sound LED on this key is lighted as well as the Sound LED in the channel indicator area); press this key twice to begin setup of a combination treatment (the Combo LED is lighted as well as the Sound LED and a single Channel LED in the channel indicator area). When either of these options is chosen, the soundhead should first be plugged into the ultrasound output jack on the side panel. For combination treatments, the special combo lead wire should be attached to the output jack selected (see full instructions for setting up a combination treatment later in this manual). In the COMBO mode, the electrotherapy treatment is delivered through the soundhead and through a single electrode which is placed on the patient. Only single-channel electrotherapy options are available in the COMBO mode.
17. SOUND FREQUENCY TOGGLE: This key is pressed one or more times to select the desired ultrasound frequency; 1 MHz, 2 MHz, or 3 MHz.
18. DUTY CYCLE TOGGLE: This key is pressed one or more times to select the desired duty cycle for ultrasound treatment. Options are 10, 20, or 50 percent, or Continuous.

Russian / Biphasic / High Volt Selections:

19. **BIPHASIC/RUSSIAN:** Press this key once to begin setup of a biphasic treatment (the Biphasic LED is lighted); press this key twice to begin setup of a Russian treatment (the Russian LED is lighted). Biphasic and Russian treatments use a single channel (1, 2, 3 or 4) when the Normal mode is selected; and a channel pair (1-2 or 3-4) when the Reciprocal or Co-contraction mode is selected.
20. **HIGH VOLT:** Press this key to begin setup of a High Volt treatment (the Hi Volt LED is lighted). Either HV1 or HV2 output channel is automatically selected (the LED for the channel selected is GREEN). Connect the patient lead wire to the HV output jack indicated by the green LED.

HIGH VOLT POLARITY: To select or change the polarity of a high volt treatment, use the HI VOLT key together with the FUNCTION key. Press and continue holding the FUNCTION key while pressing the Hi Volt key one or more times to select positive only (the "+" LED is lighted), negative polarity only (the "-" LED is lighted), or both (both LEDs are lighted).

21. **TREATMENT MODE TOGGLE** (for biphasic and Russian treatments): Press this key one or more times to select Normal, Co-Contraction, or Reciprocal contraction. The output channel is automatically selected. When Normal is selected, one output jack only is selected. When Co-contraction or Reciprocal is selected, a channel pair is selected (either channels 1-2 or channels 3-4). Connect the patient lead wire(s) to the output jack(s) for the channel(s) selected.
22. **CONTRACTION/REST CYCLE TOGGLE** (for Russian, biphasic, and high volt treatments): Press this key one or more times to select the desired contraction/rest (on/off) cycle. Available cycles include 10/10, 10/30, 10/50, and Continuous. The first value indicates the on-time in seconds, and the second value indicates the off-time. For example; 10/30 indicates the current is on (muscle is contracting) for 10 seconds, and current is off (muscle is relaxed) for 30 seconds. With Continuous mode, current is applied continuously with no off cycle. The continuous duty cycle is not recommended for electrical muscle stimulation, but may be used for settings that are intended to effect other results than a muscle contraction.
23. **RAMP TIME TOGGLE** (for Russian, biphasic, and high volt treatments): This key is pressed to select the ramp time. The ramp time is applied before and after the "On" segment of the cycle (it provides both a ramp up and a ramp down). Available ramp times are .5, 1, 1.5, and 2 seconds.

NOTE: The High/Low option described previously under the Interferential/Premod options is also used for High Volt treatments (see item 13 above).

Microcurrent Selections:

24. **MICRO:** Press this key to begin setup of a microcurrent treatment. This key is also used to turn the conductance tone off and on after a microcurrent treatment is started. When MICRO is selected, Channel 1 is automatically selected for the default electrodes treatment and the LED for that channel is lighted. For a microcurrent treatment setup with electrodes, connect a patient lead wire to Channel 1 output jack. For a microcurrent probes treatment, press the channel toggle key (CH) to select the MICRO channel

selection (Channel 1 LED will become yellow and MICRO will become green to indicate the probes option is selected). Connect the microcurrent probe to the microcurrent output jack on the left side panel of the device.

NOTE: Channel 1 is committed to the microcurrent output during a probes treatment as well as during a treatment with electrodes, and is not available for use by any other modality while any microcurrent treatment is in progress.

MICROCURRENT POLARITY: To select or change the polarity of a microcurrent treatment, use the MICRO key together with the FUNCTION key. Press and continue holding the FUNCTION key while pressing the MICRO key one or more times to select positive only (the “+” LED is lighted), negative polarity only (the “-” LED is lighted), or dual polarity (both LEDs are lighted).

25. OUTPUT JACK CHANNELS 1, 2, 3, and 4: These are the output jacks for delivering interferential, premodulated, Russian, biphasic, and microcurrent treatments. Consult treatment instructions later in this manual for appropriate channels and treatment setup for each modality.
26. HIGH VOLT OUTPUT JACKS CHANNELS HV1 and HV2. These are the output jacks for delivering high volt treatments. Consult treatment instructions later in this manual for high volt treatment setup.

Dynatron 950plus and 650plus Back Panel:

27. POWER ON/OFF SWITCH: Located on the back of the unit this switch is labeled “1” and “0”. Set the switch to “1” for ON; set the switch to “0” for OFF.
28. STIM INPUT JACK FOR COMBINATION TREATMENTS: The special lead wire for combination treatments is plugged into this

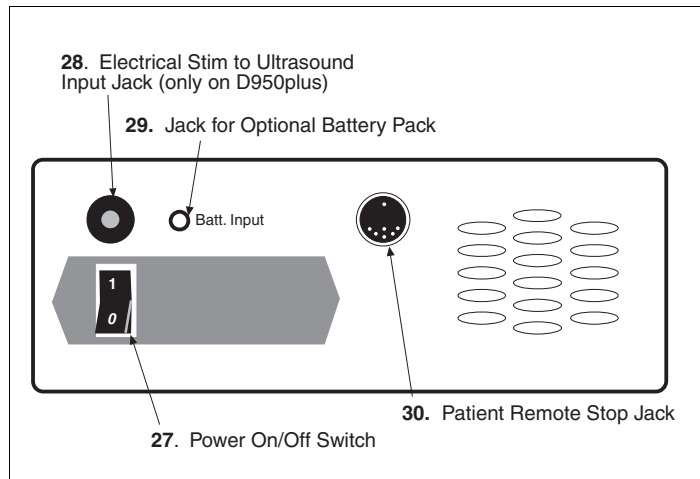

Dynatron 650plus and 950plus Back Panel

- jack for a combination treatment setup providing stim output through the ultrasound head. The special lead wire is also plugged into the jack on the front of the device which has been selected for the specific combo treatment. See combination treatment instructions later in this manual for detailed information regarding combination treatment setup.
29. BATTERY: This jack may be used to supply power to the device using an optional battery pack. More information about the optional battery operation is provided later in this manual.
30. REMOTE STOP: A cord with a remote stop button is inserted in this jack. The remote stop is controlled by the patient during unattended therapy to allow the patient to stop the treatment at any time. When the button on the remote stop cable is pressed, output for all stim modalities is stopped and the tone sounds briefly. During Combo treatments, both sound and stim outputs are stopped.

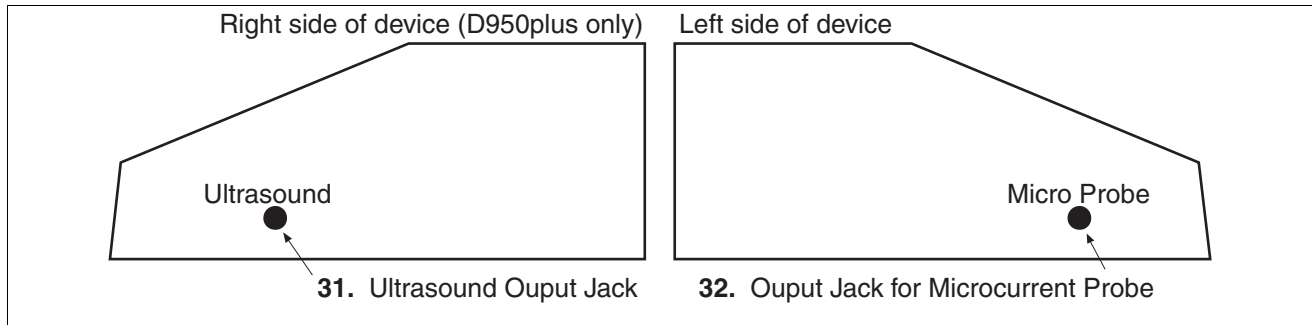

Side Panels

Dynatron 950plus and 650plus Side Panels:

31. **ULTRASOUND OUTPUT JACK (DYNATRAN 950plus ONLY—not available on the Dynatron 650plus):** The applicator soundhead plugs into this jack for ultrasound therapy.
32. **MICROCURRENT OUTPUT JACK:** The microcurrent probe plugs into this jack for microcurrent probe therapy.

Instructions for Using Toggle Keys

Toggle keys are used to make selections from two or more options in a given area. Toggle keys are pressed one or more times to make a desired selection. A **GREEN light** (LED) next to the toggle key shows the option that has been selected. Pressing the toggle key one or more times allows you to scan through the available options.

Each toggle key has unique capabilities. Most toggle keys allow only one selection. For example, the Ramp toggle key requires you to select just one of the four ramp times available. However, some toggle keys allow you to select two options. For example, in interferential you can press the High/Low toggle key once to select High, press again to select Low, and press again to select both High and Low.

The following is a list of all the toggle keys available with each modality:

IFC and Premod

- Target/Sweep (IFC only)
- High/Low Frequency Ranges

Russian and Biphasic Stim

- Treatment mode
- Contraction/Rest cycle
- Ramp Time

High Volt Stim

- Contraction/Rest cycle
- Ramp Time
- Polarity
- High/Low Pulse Rate Ranges

Microcurrent

- Microcurrent Polarity
- Channel toggle to select Micro or Channel 1 (during setup only)

All Modalities

- Time/Frequency/Rate/Width
- Channel Toggle (to view individual channels one at a time while treatments are in progress)

Ultrasound (Dynatron 950plus only)

- Ultrasound Frequency
- Ultrasound Duty Cycle

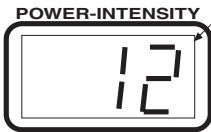
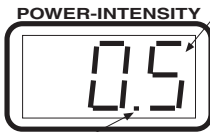
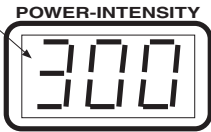
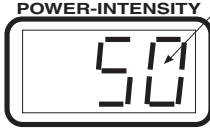
<p>Stim Intensity Display The intensity display is intended as an incremental value only for the convenience of the practitioner.</p>  <p>Increasing the intensity does increase current delivery. However, intensity and current are not a 1:1 comparison. Actual current delivered to the patient depends upon the intensity setting and the current density (affected by the size and condition of the electrodes).</p>	<p>Ultrasound Power Display Ultrasound power is displayed, with the value shown either in WATTS or W/cm2.</p>  <p>A blinking decimal indicates the power is displayed as WATTS. A steady (non-blinking) decimal indicates WATTS/cm2. Pressing and holding the PAUSE key changes the display from WATTS to W/cm2 or reverse.</p>
<p>Microcurrent Intensity Display Microcurrent intensity is displayed in microamperes</p> 	<p>High Volt Intensity Display High volt intensity is displayed in volts</p> 

Examples of Power-Intensity displays for the Dynatron 950plus and 650plus.

Time and Power Displays

The “Time” display and the “Power-Intensity” display can show the settings for only one channel at a time. The Time and Power-Intensity settings displayed are for the channel with the GREEN light only. Any other channel in use at that time will have a YELLOW light to show it is active but its parameters are not currently displayed.

To view the settings for another channel or output, press the channel toggle key one or more times until the light for the desired channel becomes GREEN. The GREEN light appears next to a different channel or output each time you press the toggle key, and the Time and Power-Intensity displays change to show the parameters currently in effect for that channel.

The green and yellow channel lights each will also appear solid (non-flashing) or flashing. A solid light means current is being delivered to the channel at this time (for example, during the ON cycle of the Russian stimulation treatment). A flashing light means current is not being delivered to the channel at this time (for example, during the OFF cycle of the Russian stimulation treatment).

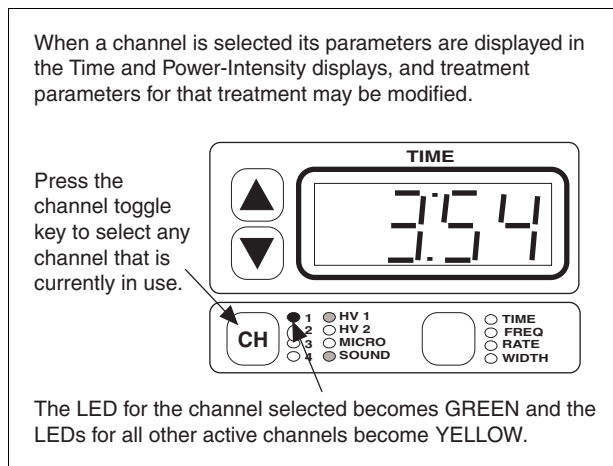

Channel Toggle Key

CHANNEL / OUTPUT INDICATOR LIGHTS

- | | |
|------------------------|--|
| GREEN Solid | <ul style="list-style-type: none"> You CAN see this channel's parameters displayed on Time and Power-Intensity displays. The channel IS delivering current. |
| GREEN Flashing | <ul style="list-style-type: none"> You CAN see this channel's parameters displayed on Time and Power-Intensity displays. The channel IS NOT delivering current. |
| YELLOW Solid | <ul style="list-style-type: none"> You CANNOT see this channel's parameters displayed on Time and Power-Intensity displays. The channel IS delivering current. |
| YELLOW Flashing | <ul style="list-style-type: none"> You CANNOT see this channel's parameters displayed on Time and Power-Intensity displays. The channel IS NOT delivering current. |

Ultrasound Heads (Dynatron 950plus only)

The Dynatron 950plus features the new Dynatronics SmartHead™ ultrasound applicator soundhead that has all calibration information self-contained. SmartHeads may be used interchangeably with any 50 Series Plus model or the Dynatron 125 model with no need for entering calibration numbers into the device.

Soundheads for the Dynatron 950plus come in 1 cm², 2 cm², 5 cm², and 10 cm² sizes. The 2 cm², 5 cm², and 10 cm² soundhead operate at 1, 2, and 3 MHz; while the 1 cm² soundhead operates at 2 and 3 MHz. The soundheads are waterproof allowing ultrasound (not combination) therapy to be administered in water, if desired.

Do not drop the soundhead nor allow it to strike a hard surface. Do not place soundheads into ice water. Do not allow soundheads to repeatedly reach maximum head temperature.

All of these conditions can cause damage to the crystal. Any such damage is not covered by the warranty.

For new or replacement soundheads, contact Dynatronics or your authorized Dynatronics representative.

Microcurrent Probes (optional accessory)

The Dynatron 950plus and Dynatron 650plus devices offer optional probes for delivering hands-on microcurrent treatment. The microcurrent probes can only be used for microcurrent therapy. It is not possible to select the probe output or to use the microcurrent probe to deliver a probe treatment for interferential, premodulated, Russian, biphasic, or high volt modes.

The setup includes an active probe along with either a ground probe or a ground electrode. Use the end of a cotton swab (such as a Q-Tip®) inserted into the ends of both the active probe and the ground probes. Cut the end of the swab to a short length; the cotton must touch the probe's metal ring. Use water or a conductive electrolyte spray to wet the cotton swab before treating.

Active Probe: To deliver the current to the patient through the active probe, press and release the button on the probe. Press and release the button again to stop the current. The active probe should touch the patient's skin at the treatment site, and the ground probe should touch the patient's skin elsewhere. This completes the circuit and delivers current to the patient. You do not need to hold the button down. Once you have pressed and released the button, the current is delivered until you press and release the button again to stop the current.

While you are delivering current, the treatment timer counts up in seconds from zero. When the current is stopped, the timer returns to zero. Press the button again to commence the next time sequence. Continue in this way until treatment is completed.

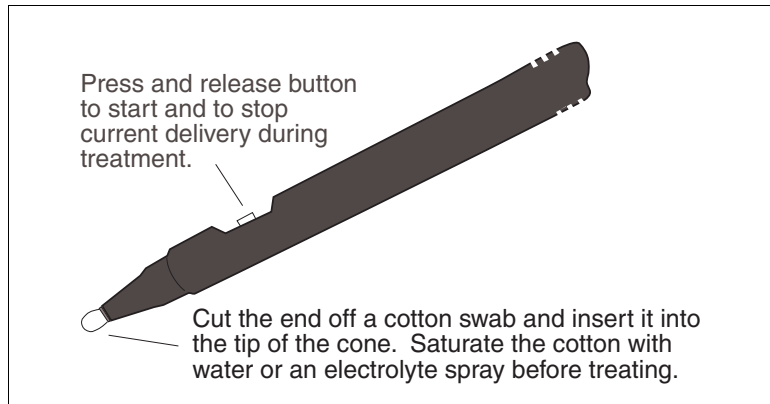

Microcurrent Active Probe (optional accessory)

Ground Probe: The ground probe is attached directly to the banana pin connector on the probe cable. This probe is used to complete the circuit to allow flow of current through patient tissue. The ground probe should touch the patient's skin at any location away from the treatment point. As an alternative, you may also use a ground electrode as explained below, in place of the ground probe. This is particularly convenient when treating in several different places around one point.

Ground Electrode: You can use an electrode in place of the ground probe. Just unplug the ground probe from its cable, attach a banana-to-pin adapter to the cable, then attach an electrode to the pin. Place the electrode on the patient at a site where it will not interfere with placement of the active probe during treatment. The banana-to-pin adapter is an optional accessory available from Dynatronics.

High Volt Probe (optional accessory)

An optional probe may be purchased which allows you to deliver an attended high volt treatment. The high volt probe is connected to its one of the dedicated high volt jacks (HV1 or HV2) on the front of the machine. The probe is used in conjunction with a large dispersive electrode. The high volt probe is used only for delivering high volt therapy.

Complete setup and use instructions are provided in this manual under the treatment setup instructions for high volt.

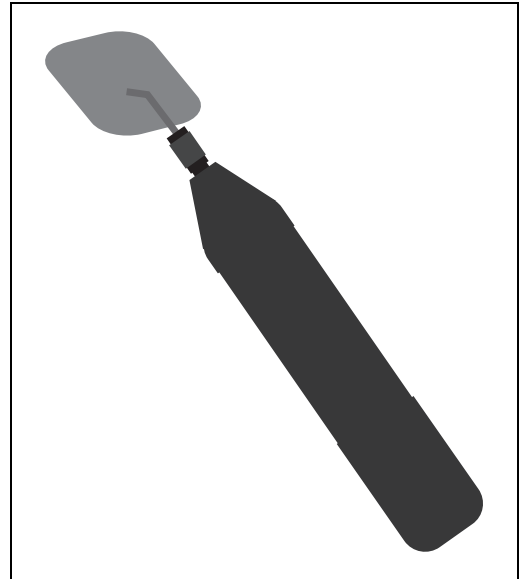

High Volt Probe (optional accessory)

Quick Reference of Special Key Presses

The following is a brief list of special key presses available with this device. These options are explained in detail where they apply in the treatment instructions later in this manual. NOTE: Where two keys are required (i.e., FUNCTION-STOP) you must press both keys simultaneously to achieve the result.

KEY PRESS	RESULT	DESCRIPTION
FUNCTION-STOP	STOP TREATMENT	Stop one treatment
FUNCTION-HI VOLT	CHANGE HIGH VOLT POLARITY	Change high volt polarity. Repeat to change again.
FUNCTION-TIME	CONDUCTANCE BAR GRAPH	Press during IFC, Premod or Microcurrent treatment to view conductance bar graph. Press TIME to return to normal display.
FUNCTION-SOUND	HEAD WARMING ON/OFF	Set head warming feature to on (HD 1) or off (HD 0)
SOUND-TARGET	ULTRASOUND COUPLING BAR GRAPH	During an ultrasound treatment only, press to view the ultrasound coupling bar graph. Press TIME to return to normal display.
SOUND-HI/LO keys	SOUNDHEAD TEMPERATURE BAR GRAPH	During an ultrasound treatment, press to view the ultrasound head temperature bar graph. Press TIME to return to normal display.
FUNCTION	DISPLAY WATTS or W/cm ²	During ultrasound treatment, hold for 2 seconds to change ultrasound power display from w/cm ² to Watts or reverse.
FUNCTION-TARGET/SWEEP key	TEST LEADS	Enter the Lead Test Function. Then press START to begin lead test, and press STOP to exit the lead test function. NEVER DO THIS WHILE ELECTRODES ARE ATTACHED TO PATIENT.
FUNCTION-MICRO	CHANGE MICROCURRENT POLARITY	Change microcurrent polarity. Repeat to change again.
MICRO	AUDIO TONE ON/OFF	During a microcurrent treatment, turn audio tone on and off.
FUNCTION-INTENSITY UP & DOWN ARROW KEYS	CHANGE VOLUME	Change loudness of tone (during microcurrent treatment only)
START	SAVE NEW DEFAULT SETTINGS	Hold for 2 seconds to save defaults for current treatment.

AT POWER ON, HOLD DOWN THE FOLLOWING KEYS WHILE THE DEVICE STARTS UP:

TARGET/SWEEP	LEAD TEST MODE	Press and hold on power up to enter Lead Test feature.
START	RESTORE FACTORY SETTINGS	Press and hold on power up and wait for beep to restore factory default settings.
FUNCTION	ENTER CALIBRATION MODE For Technicians Only	Press and hold during power up for soundhead calibration mode.
ULTRASOUND DUTY CYCLE KEY	ENTER SOUNDHEAD PARAMETERS For Technicians Only	Press and hold during power up for soundhead parameter mode.
FUNCTION-TIME MODE KEY <i>(Rev 1.02 and later)</i>	DISABLE CONDUCTANCE BAR GRAPH	Press and hold these keys at the same time to disable the conductance bar graph for treatment setup (the graph will still be available for viewing after a treatment has started). After the device starts up, select 1 (in the intensity screen) to turn the option on and 0 to turn the option off.
FUNCTION-INTENSITY DOWN ARROW <i>(Rev 1.02 and later)</i>	DISABLE ULTRASOUND COUPLING DETECTION	Press and hold these keys to disable the ultrasound coupling detection feature. The Time display will show the current setting briefly: CP1=feature on, CP0=feature off. Repeat this step to revert to the prior setting.

Section II

Operation and Treatment Instructions

General Operating Instructions

Power On/Off

Press the power switch located on the rear panel of the unit. The self-diagnostic and calibration function automatically occurs each time the unit is turned on. It is recommended that the unit remain on throughout the day if it is used on a regular basis.

CAUTION: Never turn power on or off while the unit is connected to the patient. Set intensity to minimum power before pressing START.

Basic Treatment Setup

Treatment setup is simple and fast with the Dynatron 950plus and 650plus. Each modality has default settings that are automatically selected when you press a modality key. The basic steps for setting up any treatment are:

1. **Press a modality key once or twice to choose the desired modality** (IFC, Premod, Russian, Biphasic, High Volt, Micro, Sound, or Combo). The lighted LED on the key indicates the modality chosen. The first available output channel(s) and default settings for that modality are automatically selected. For ultrasound and combination treatments, the soundhead must be connected to the device before selecting Sound or Combo.
2. **Plug lead wires or probe cable into the appropriate jack(s)** on the device for the modality to be delivered. **Observe which channels the device selected for this treatment—channels are selected automatically by the device.** Attach the electrodes to the leads, and affix the electrodes to the patient. For unattended stim treatments, attach the Remote Stop cable, and give the cable to the patient
3. **Change any options** desired using the toggle keys available for that modality.
4. **Increase power or intensity.** Current delivery to the patient starts when you increase intensity. Only do this when you are ready to proceed with the treatment.
5.
 - For Target treatments only, locate the treatment site using the Target pad.
 - For Russian / biphasic two-channel treatments, press Start or the channel toggle key after setting the intensity for the first channel, then set the intensity for the second channel.
 - For Combo treatments, set the parameters for the stim modality (or ultrasound), press Start, then set parameters for ultrasound (or stim), then press Start again. You can select the desired stim modality in this step by pressing the desired modality key after pressing Combo.
6. **Press Start.** The treatment timer begins.

7. **Administer treatment** until the treatment time expires, or **press STOP** to stop all treatments in progress at any time.

Each of the therapies you can deliver with the Dynatron 950plus and 650plus offers its own default settings. To make your treatment setup even more convenient, the Dynatron 950plus and 650plus allow you to change the defaults for each modality to your own most common treatment selections. See “Setting Defaults” later in this manual.

The following pages provide more detailed setup instructions for each individual modality. **Before administering a treatment to a patient, be sure to read all treatment instructions as well as contraindications, warnings, and precautions for that modality provided later in this manual.** Also, consult published literature for recommended application of these modalities.

Conductance Bar Graph

This feature for models having software greater than Rev. 1.01 only (see Page 2).

During setup of an interferential or premodulated treatment, a conductance graph is automatically displayed in the Time display while you set the treatment intensity. The graph allows you to see whether conductance is good for that treatment setup and if current is being delivered efficiently through the electrodes. The display reverts to the Time display when you press any other key after setting the intensity. You may again view this conductance graph at any time during an interferential, premodulated, or microcurrent treatment by pressing FUNCTION-TIME. The conductance bar graph is not available for combination treatments.

The bar graph uses the eight segments in the top half of the display, with eight lighted segments indicating best conductance, and one lighted segment indicating poorest conductance. In the illustration below, eight of the eight segments are lighted indicating good conductance.

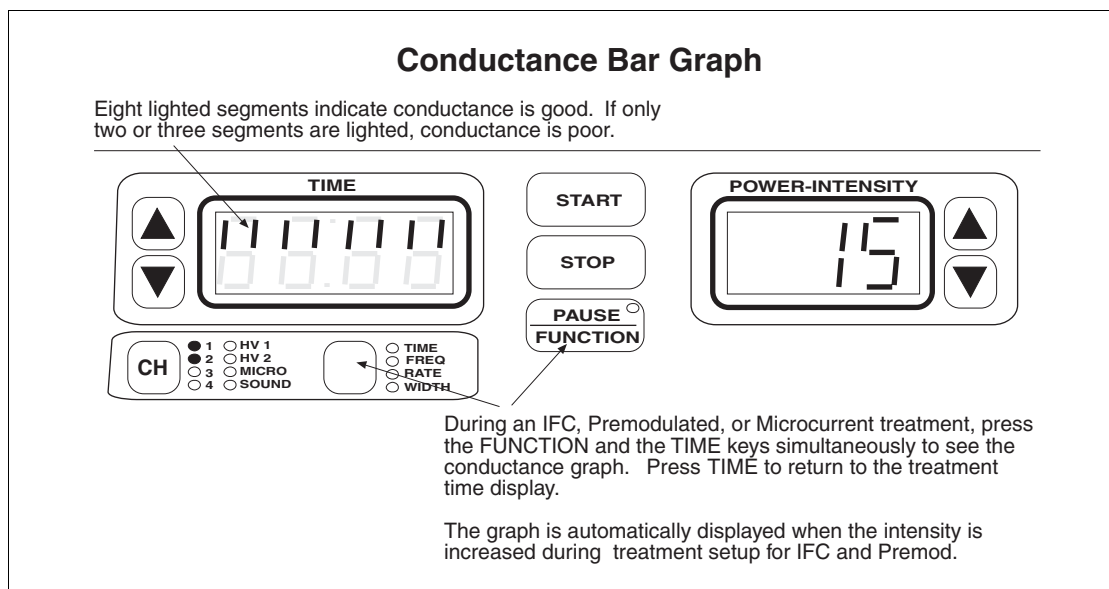

Conductance Bar Graph.

If the graph indicates poor conductance, check to be sure leads and electrodes are in good condition, that leads are fully plugged in and the entire surface of the electrode is making contact with patient's skin. Extremely dry skin can also be a cause of poor conductance. If leads or electrodes are found to be worn, they should be replaced. Leads may be tested using the Lead Test function described in the operator's manual for this device. Guidelines for replacing leads and electrodes are also provided in the operator's manual.

When you no longer wish to view the conductance graph, press the TIME key to redisplay the treatment time. NOTE: The treatment time counter does not stop, but continues counting down when the graph is displayed.

Disable the Conductance Bar Graph. If you do not wish to see the conductance bar graph automatically during the treatment setup, you can disable this function. Press and hold the FUNCTION and TIME mode keys while powering the device on (**NEVER TURN THE DEVICE ON OR OFF WHILE LEADS ARE CONNECTED TO A PATIENT**). When the device completes starting up, the word "bar" appears in the TIME display, and "1" appears in the Power/Intensity display. Use the intensity up/down arrow keys to change from "1" to "0" (select 1 to turn this option on, select 0 to turn the option off). Press START after making your selection. Once you have disabled the automatic portion of this option, the device will default to the disabled mode each time the device is powered on. However, you may still view the conductance graph at any time after the treatment has started as described above. If you wish to reset the default to re-enable the bar graph to appear automatically during treatment setup, again press and hold the FUNCTION and TIME mode keys while powering the device on and select the desired setting.

"LEAD" Warning - No Patient Current

This feature for models having software greater than Rev. 1.01 only (see Page 2).

This added safety feature warns you if the device detects an "open" or incomplete circuit during setup of an interferential treatment. An open can be due to a lead that is not plugged in, an electrode that has fallen off or otherwise is not making contact with the patient, or another reason that would cause an incomplete circuit. When this occurs, current is not being delivered to the patient, and the condition must be corrected before continuing with treatment setup.

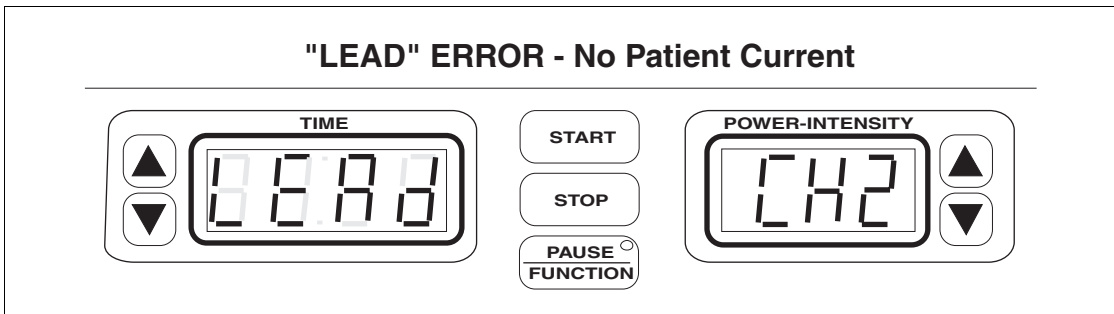

No Patient Current. During an interferential treatment setup, if an open is detected, the "Lead" warning is displayed along with the channel number that triggered the error.

When the device detects this condition during the treatment setup, it will beep and display "LEAD" in the Time display, and will indicate in the Intensity display the number of the channel that has triggered the error (for example, CH1), and you will be unable to increase the intensity setting. If this error occurs, reduce the intensity for the channel indicated, correct the condition, then return the intensity to the desired treatment level. In adjusting

intensity, always observe the warnings and precautions provided in the operator's manual for this device.

This error will not occur if the intensity is set below 11. The error condition can also be detected during setup of premodulated treatments at the High frequency settings. The error warning will also occur while a treatment is in progress under the same conditions described above, but will only be displayed if the affected channel is currently selected for display.

Disable the Lead Warning. If you find the lead warning feature is too sensitive for your treatment setup and is detecting conditions that are not truly open, you can adjust the sensitivity. To do this, press and hold the IFC key while powering the device on (**NEVER TURN THE DEVICE ON OR OFF WHILE LEADS ARE CONNECTED TO A PATIENT**). The word "OPEN" is displayed in the Time display, and the default setting of 24 is displayed in the Intensity display. A lower number provides reduced sensitivity. At a zero setting no error will be displayed. Use the up/down arrow keys to change the setting, then press Start to exit this mode. The setting you select will remain as the default for the device until you change it.

Interferential / Premodulated Instructions

WARNING

- **NEVER** turn the power on or off while the unit is connected to the patient.
- Always give the Remote Stop cable to the patient prior to the treatment.
- Always **STOP** a treatment before removing or attaching electrodes or leads. Leads and electrodes must only be applied to the patient before a treatment is started.
- Never use worn or damaged leads or electrodes as these may result in injury to the patient.
- See the contraindications, warnings, and precautions for interferential and premodulated treatments in this manual before administering a treatment to a patient.
- Additional warning from the Canadian Health and Welfare Department, Health Protection Branch: **WARNING: Thoracic applications are contraindicated. Cardiac fibrillation may occur if output current is 50 mA RMS or greater for any output circuit. (For use in Canada and Japan, this device is limited to 50mA output.)**

An interferential treatment uses two channels and four electrodes (channel pairs 1-2 or 3-4). The device will automatically select the first available channel pair when you select IFC. A premodulated treatment uses one channel and two electrodes. The device will automatically select the first available channel (1, 2, 3, or 4) when you select PREMOD. If desired, you may set up multiple treatments using available channels.

Basic Interferential / Premod Setup

1. Choose **IFC** or **PREMOD**.
 - Plug the patient lead(s) into the output jack(s) for the channel(s) selected.
 - Attach electrodes to patient at treatment site.
 - Give the remote stop cable to the patient.
2. Set the treatment **TIME**.
3. (Optional) **CUSTOMIZE FREQUENCIES** now.
4. Choose **HIGH, LOW**, or **HIGH/LOW** alternating, or **HIGH/LOW** consecutive.
5. Choose **TARGET, SWEEP** or **STATIC** (for Interferential treatments only)
6. Increase **INTENSITY** (patient will feel the current).
7. Press **START**.
8. Press **STOP** if you need to stop a treatment before its time has expired (stops all current treatments).

NOTE: Prior to increasing intensity, electrodes must be placed on the patient and the lead(s) attached to the device. **Plug the lead(s) into the channel(s) the device selects for this treatment.** Give the remote stop cable to the patient. Consult published sources for electrode placements, treatment settings, and treatment times. Make sure electrodes make good contact with the patient's skin over the entire surface area of the electrode. Improper electrode contact may result in patient injury.

Detailed Interferential / Premodulated Setup

1. Press the **IFC / PREMOD** key once to choose IFC (interferential), or press this key twice to choose PREMOD (premodulated).

When you choose IFC, channels 1-2 or 3-4 are automatically selected. When you choose PREMOD, the first available channel is selected. Make sure the patient lead is plugged into the correct jack(s) for the channel(s) selected. The default settings for the modality are automatically selected too, and if you wish to use the default settings, you can now increase the intensity to the desired level, then press START.

If you wish to change the treatment settings, do the following steps.

2. Set **TIME**.

The default treatment time is displayed. Use the Time arrow keys to increase or decrease the treatment time.

3. Customize the **FREQUENCY** settings (optional).

The default High and Low frequency settings are:

The HIGH range is 80 to 150 Hz.
The LOW range is 0 to 10 Hz.

These ranges may be changed for a single treatment if desired, or new default settings may also be saved to apply to all future treatment setups. The same default setting applies to both interferential and premodulated treatments.

You may change the frequency settings for the range you plan to select for this treatment, if desired (see illustration next page). Each interferential or premodulated treatment may have its own frequency settings. After you press START to begin the treatment, frequency settings will remain in effect for the duration of the treatment. If you save defaults during this treatment, the new frequency settings you have entered become the defaults for this modality. However, if you do not save the new settings, the unit will return to the current default settings for the next treatment.

To modify the frequency during setup, first, press the toggle key and select either the HIGH or the LOW frequency range. Next press the TIME toggle key to select **FREQ**. The **FREQ** light under the TIME display becomes green and you will see the current frequency range settings displayed in the Time and the Intensity displays as shown in the diagram on the following page. With **FREQ** selected and either the HIGH or LOW range selected, you may use the up/down arrow keys to change the upper and lower limits of the range chosen. If you set both displays to the same value, the treatment will be delivered at that single frequency rather than sweep through a frequency range.

When you are finished setting the frequencies, press the Time toggle key to return to the Time display. After 10 seconds with no key presses, the Time display automatically returns.

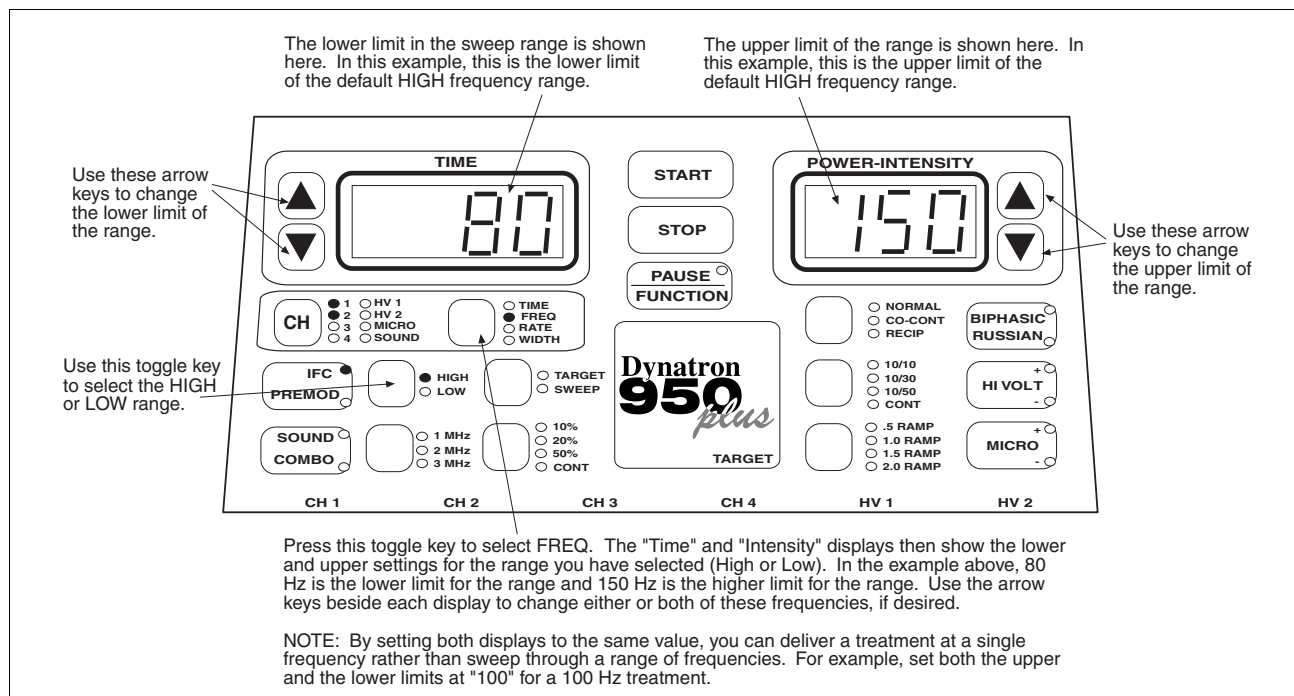

Modify frequency ranges in Interferential or Premodulated treatments.

4. Choose **HIGH, LOW, HIGH/LOW alternating, or HIGH/LOW consecutive.**

Press the HIGH/LOW toggle key one or more times to select the high frequency range, the low frequency range, or both. The lights next to the toggle key show what you have selected. Select from the following options:

- a. High only. Toggle until only the High light is on.
- b. Low only. Toggle until only the Low light is on.
- c. High/Low Alternating. Toggle until both High and Low lights are on, only one of these is flashing. When the treatment has started, the device alternates between the two modes at intervals of approximately 30 seconds each beginning with Low.
- d. High/Low Consecutive. Toggle again; both High and Low are flashing. During the first half of the treatment time the High frequency range is delivered. During the second half of the treatment time the Low frequency range is delivered. NOTE: Make any desired changes to the treatment time before selecting Consecutive. Treatment time changes made after selecting Consecutive will cause the treatment to revert to an alternating treatment (option c. above).

Once the treatment has started, the frequency range (High or Low) being delivered at a given time is indicated by the flashing High or Low light.

5. Increase **INTENSITY**.

Set the intensity by pressing the Intensity UP arrow key. When you increase intensity, current to the patient begins. Intensity can be decreased by pressing the Down arrow key. NOTE: For devices having software greater than Rev. 1.01, the conductance bar graph is displayed while intensity is being set or changed. See page 21 for a complete explanation of the conductance bar graph.

Before selecting the intensity setting for an individual patient, see “Electrotherapy Usage Cautions” in this manual for recommended intensity settings. Also see the section of this manual entitled “Contraindications, Warnings, and Precautions” for specific precautions when treating any conditions contributing to loss of sensation, or **any time the patient cannot feel the electrical stimulation.**

6. Choose **TARGET, SWEEP, or STATIC** (for interferential only).

TARGET. Press the toggle key to select this option if it is not already selected. The patented Target feature allows you to pinpoint the treatment site to deliver the full interferential current where it is needed. NOTE: You must set the intensity before using the Target Pad so the patient will be able to tell you when the treatment site is found. Also remember, an injured area will often be more sensitive to the current delivered. Therefore, an intensity setting that is comfortable to the patient at first may feel uncomfortable when the treatment site is found using the Target pad. If necessary, reduce the intensity to the patient’s comfort level.

SWEEP. Press the toggle key one or more times to select this option. This option uses Dynatronics’ patented Target feature to automatically move the point of interference in a somewhat spiral fashion covering 75 to 80 percent of the area within the electrodes. This allows you to bathe a more general area with the interferential current while retaining the full interferential beat.

STATIC. This option is applied when neither Target nor Sweep are selected. Press the toggle key one or more times to unselect those options (the LEDs will both be off). The treatment becomes a STATIC treatment. In other words, it simply allows the two currents to take a path of least resistance and intersect at a natural point within the electrodes.

7. Press **START**.

When you press start, the treatment timer begins counting down and the treatment proceeds. If you fail to set the intensity before pressing START, the intensity display will begin flashing, and you will be unable to start the treatment until you set the intensity.

SAVE DEFAULTS. If the treatment you have just set up is a common treatment setup you use, you can save the treatment parameters as new defaults for your own machine. After setting up the treatment, simply press and hold the START key for two seconds. At the end of two seconds, you will hear a beep indicating the treatment parameters have been saved. The next time you select that modality, these parameters are selected automatically.

8. **MODIFY** settings.

While the treatment is in progress, you can modify any of the treatment parameters, if desired. Note: If you change the treatment time during a consecutive High/Low treatment, the treatment will revert to alternating High/Low.

- Use the High/Low toggle key to select a different frequency option (High, Low, or High/Low alternating only. High/Low consecutive is only available during treatment setup).
 - Use the Target/Sweep toggle key to change this option (IFC only)
 - Use the Time arrow keys to increase or decrease the treatment time.
 - Use the Intensity arrow keys to increase or decrease the intensity.
 - Relocate the treatment site by touching the Target pad at any time during the treatment (only when Target is selected).
9. Press **STOP** if it is necessary to stop a treatment before time has expired.

When the treatment time has elapsed, the current to the patient stops and a tone sounds notifying you of the treatment end. Treatments in progress may be stopped at any time using one of the following methods.

STOP: Press this key to stop all treatments at all channels.

REMOTE STOP: During “unattended therapy,” a patient stop button is provided to allow the patient to stop treatment. The remote cord should be plugged into the machine prior to starting the treatment. When the remote stop button is pressed, all output from the device is stopped, time is set to zero, and a tone sounds briefly.

STOP ONE TREATMENT ONLY: If you have more than one treatment in progress, you can stop one treatment by either of the following methods. First, press the channel toggle key to select the channel to be stopped (that channel’s light is green when selected).

FUNCTION-STOP. Press and hold the FUNCTION key and press STOP.

REDUCE THE TREATMENT TIME TO ZERO. Press the Time down arrow until the Time display reaches zero. The device beeps when the time reaches zero.

The output at the selected channel is stopped, and the device then displays the parameters for the next treatment that remains in progress (if any).

Interferential / Premodulated Default Settings

The following default settings are set by the manufacturer and are selected when you select IFC or PREMOD. You may change these defaults to your own preferred settings. See “Setting Defaults” in this manual.

Interferential

- High frequency range
- Target
- Time: 10 minutes

Premodulated

- High frequency range
- Time: 10 minutes

Biphasic / Russian Instructions

WARNING

- NEVER turn the power on or off while the unit is connected to the patient.
- Always give the Remote Stop device to the patient prior to the treatment.
- Always STOP a treatment before removing or attaching electrodes or leads. Leads and electrodes must only be applied to the patient before a treatment is started.
- Never use worn or damaged leads or electrodes as these may result in injury to the patient.
- See “Contraindications, Warnings, and Precautions” in this manual before administering a treatment to a patient.

In the Russian and Biphasic Stimulation modes the output of the device is a pulsed sinusoidal wave. The Dynatron 950plus and 650plus allow the operator to choose a muscle contraction/relaxation cycle that is most suited for the individual patient and for the desired treatment. When the cycle required is chosen, each muscle-stimulating burst is followed by a relaxation (rest) cycle. See “Russian/Biphasic Parameters” in this manual for further discussion of pulse rate and width, and illustrations showing the segments of the Russian Stimulation cycle and the Biphasic Stimulation cycle.

The Dynatron 950plus and 650plus provide three modes of treatment in Russian and Biphasic Stimulation: Normal, Reciprocal and Co-Contraction. You will need to decide which mode is to be used and attach the appropriate number of leads needed when setting up the treatment.

NORMAL: Use one channel with one lead wire (two electrodes). Place the electrodes so as to treat through the muscle. The contraction/relaxation cycle is selected from an option list of 10/10, 10/30, 10/50, and Continuous (there is no rest cycle with Continuous). Each time period is indicated in seconds. For example, 10/30 indicates 10 seconds of stimulation with 30 seconds of relaxation. The continuous duty cycle is not recommended for electrical muscle stimulation, but may be used for settings that are intended to effect results other than a muscle contraction.

CO-CONTRACTION: Use two channels and two lead wires (four-electrodes) for this treatment. Each pair of electrodes is placed over a different muscle group. This treatment fires the two muscle groups simultaneously—contraction and rest cycles for both treatment areas occur at the same time. Two channels are required (1-2 or 3-4).

RECIPROCAL: Use two channels and two lead wires (four electrodes) for this treatment. The reciprocal muscle stimulation fires two muscle groups (such as reciprocal flexors/extensors) one after the other. For example, with a duty cycle of 10/30, the device would deliver stimulation for 10 seconds to the first muscle,

followed by 10 seconds of stimulation to the reciprocal muscle. The 30-second rest time follows each stimulation. The timing of the two cycles will overlap (the first muscle group is stimulated after a 30-second rest, even though the second muscle group is 20 seconds into its rest cycle). The Continuous contraction cycle is not available for Reciprocal treatments. Two channels are required (1-2 or 3-4).

Basic Biphasic / Russian Setup

1. Choose **BIPHASIC** or **RUSSIAN**.
2. Choose the **TREATMENT MODE** (Normal, Co-contraction, Reciprocal).
 - Plug the patient lead(s) into the output jack(s) for the channel(s) selected.
 - Give the remote stop cable to the patient.
3. Choose the **CONTRACTION/REST** times.
4. Choose the **RAMP** setting.
5. Change the treatment **TIME**, if desired.
6. Change the **PULSE WIDTH** and/or **PULSE RATE**, if desired.
7. Raise the **INTENSITY** to the desired level.
8. For co-contraction or reciprocal treatments, toggle to the **SECOND CHANNEL** and set the **INTENSITY** for this channel.
9. Press **START**.
10. Press **STOP** if you need to stop a treatment before its time has expired (stops all current treatments).

Detailed Biphasic / Russian Setup

If you do not understand the terms contraction, rest, ramp time, pulse width, or pulse rate, consult the diagrams in the section of this manual entitled “Biphasic / Russian Parameters.”

1. Press the **BIPHASIC / RUSSIAN** key once to choose BIPHASIC, or press this key twice to choose RUSSIAN.

When you select this modality, the default settings are automatically selected. If you wish to use the default settings, you can now increase intensity to the desired level, then press START. If you wish to change the treatment settings, do the following:

2. Choose the **TREATMENT MODE** (Normal, Co-contraction, Reciprocal).

Press the toggle key one or more times to select Normal, Co-contraction or Reciprocal contractions (these options are explained at the start of this section). Connect the patient lead wire(s) to the channel(s) selected.

3. Choose the **CONTRACTION/REST** cycle times.

Press the toggle key one or more times to select contraction/rest cycle times. Available options include 10/10, 10/30, 10/50 and Continuous. The setting of 10/30, for example, means a 10-second contraction time followed by a 30-second rest time. Note that you may not select Continuous cycle for a Reciprocal treatment. The Continuous duty cycle is not recommended for electrical muscle stimulation, but may be used for settings that are intended to effect results other than a muscle contraction.

4. Choose the **RAMP** setting (does not affect Continuous treatments).

Press the toggle key one or more times to select the desired ramp time. Available options include .5, 1.0, 1.5, and 2.0 seconds. The ramp time is applied to both the start and to the end of the contraction time, and the ramp time is in addition to the contraction time itself.

5. Change the treatment **TIME**, if desired.

The default time is displayed. Use the Time arrow keys to increase or decrease the treatment time.

6. Change the **PULSE WIDTH** and/or **PULSE RATE**, if desired.

The pulse width and rate may be modified for each channel pair (1-2 and 3-4). If you modify the pulse width/rate for a Normal one-channel treatment, the second channel in the pair will also retain those same frequencies for the duration of the treatment. Keep this in mind if you plan to set up two Normal treatments since they will share whatever frequencies you set for the first channel. **Also note that the pulse width and pulse rate may only be changed when setting up the first channel in a two-channel treatment.**

Press the Time toggle key to select either pulse width or pulse rate. The indicator lights next to the Time toggle key show you which option is currently selected. When either pulse width or pulse rate is selected, the current setting for that option is displayed in the Time display (only). You can change the setting by using the Time up/down arrow keys. You can press the toggle key again to return to the Time display, if desired. However, if you make no key presses for 10 seconds, the display automatically returns to the Time display.

The ranges and default settings for pulse width and pulse rate are listed later in this section. See “Biphasic / Russian Default Settings.”

7. Raise the **INTENSITY** to the desired level.

Set the intensity by pressing the Intensity UP arrow key. When you increase intensity, current to the patient begins. Intensity can be decreased by pressing the down arrow key.

Before selecting the intensity setting for an individual patient, see “Electrotherapy Usage Cautions” for recommended intensity settings later in this manual. Also see the section of this manual entitled “Contraindications, Warnings, and Precautions” for specific precautions when treating any conditions contributing to loss of sensation, or **any time the patient cannot feel the electrical stimulation.**

The intensity, pulse rate, and pulse width must all be considered together when setting up the treatment as all three factors affect patient comfort. It may be necessary to adjust one

or more of these parameters somewhat after the initial settings are selected to find the best settings for a given treatment and patient.

8. For co-contraction or reciprocal treatments, select the **SECOND CHANNEL** and set the **INTENSITY** for this channel.

Intensity is set for each channel separately. Press the Channel Toggle key to select the second channel. When you are setting intensity, only the channel with the solid green light is affected. If you wish to select a channel which has a YELLOW-colored light, press the Channel Toggle key until that channels' LED is selected (green).

You may only modify the parameters for the channel that is currently selected (indicated by the green LED). A green flashing LED indicates that the selected channel is in the rest segment of its cycle. If the light is green and flashing when you begin to modify intensity, pulse rate or pulse width, current is ramped up to treatment level for that channel so those parameters may be modified.

9. Press **START**.

When you press start, the treatment timer begins counting down. If you fail to set the intensity before pressing START, the intensity display will begin flashing, and you will be unable to start the treatment until you set the intensity. For Reciprocal and Co-contraction treatments, you must set the intensity for each channel separately.

SAVE DEFAULTS. If the treatment you have just set up is the most common Biphasic or Russian treatment setup you use, you can save the treatment parameters as new defaults for your own machine. After setting up the treatment, simply press and hold the START key for two seconds. At the end of two seconds, you will hear a beep indicating the treatment parameters have been saved. The next time you select this modality, these parameters are selected automatically.

10. **MODIFY** settings.

While the treatment is in progress, you can modify the treatment parameters. You will need to observe the channel indicator lights when modifying a treatment.

- When a channel's light is green, the current treatment parameters for that channel are displayed. Any changes you make to the parameters will affect the channel with the green light only.
- When a channel's light is yellow, the channel is still active, but its parameters are not being displayed and it may not be modified until it is selected. You must first press the toggle key to select the channel—its light will then become green and modifications are allowed.
- When a light is solid (any color), this indicates the channel is in the CONTRACTION segment of the cycle and current is being delivered to that channel. When a light is flashing, this indicates the channel is in the REST segment of the cycle and current is not being delivered at this time. If you select a channel for modification while its light is flashing, the device will ramp the current up on that channel before allowing you to make modifications. When the light changes from flashing green to solid green, you will be able to modify the settings for the channel.

During a Biphasic or Russian treatment you may make the following modifications:

- Use the toggle keys to select a different contraction/rest cycle.
 - Use the toggle keys to select a different ramp time.
 - Use the Time arrow keys to increase or decrease the treatment time.
 - Use the Intensity arrow keys to increase or decrease the intensity (separately for each channel).
 - Use the Time toggle key to select the Pulse Rate or Width, then use the Time up/down arrow keys to change the pulse rate (not available for Reciprocal treatments nor when two “Normal” treatments are running simultaneously on a channel pair— CH1-2, or 3-4).
11. Press **STOP** if it is necessary to end the treatment before the treatment time has expired.

When the treatment time has elapsed, current to the patient is stopped and a tone sounds notifying you of the treatment end. Treatments in progress may be stopped at any time using one of the following methods.

STOP: Press this key to stop treatment at all channels.

REMOTE STOP: During “unattended therapy,” a patient stop button is provided to allow the patient to stop treatment. The remote cord should be plugged into the machine prior to starting the treatment. When the remote stop button is pressed, all output from the device is stopped, time is set to zero, and a tone sounds briefly.

STOP ONE TREATMENT ONLY: If you have more than one treatment in progress, you can stop one treatment by either of the following methods. First, press the channel toggle key to select the channel to be stopped (that channel’s light is green when selected).

FUNCTION-STOP. Press and hold the FUNCTION key and press STOP.

REDUCE THE TREATMENT TIME TO ZERO. Press the Time down arrow until the Time display reaches zero. The device beeps when the time reaches zero.

The output at the selected channel is stopped, and the device then displays the parameters for the next treatment that remains in progress (if any).

Biphasic / Russian Default Settings

The following default settings are set by the manufacturer and are selected when you select Biphasic or Russian. You may change these defaults to your own preferred settings. See “Setting Defaults” in this manual.

- Normal mode
- 10/30 contraction/rest times
- Treatment time: 10 minutes
- Ramp up and down time: .5 sec.

Biphasic Stimulation:

	Default Setting	Valid Range
Pulse Rate	50 Pulses per second	1 to 500
Pulse Width	200 µSec	50 to 400 µSec

Russian Stimulation:

	Default Setting	Valid Range
Pulse Rate	50 Pulses per second	1 to 500 (depends on Pulse Width)
Pulse Width	10 mSec	.4 to 50 mSec

High Volt Instructions

WARNING

- NEVER turn the power on or off while the unit is connected to the patient.
- Always give the Remote Stop device to the patient prior to the treatment.
- Always STOP a treatment before removing or attaching electrodes or leads. Leads and electrodes must only be applied to the patient before a treatment is started.
- Never use worn or damaged leads or electrodes as these may result in injury to the patient.
- See “Contraindications, Warnings, and Precautions” in this manual before administering a treatment to a patient.

High volt electrical stimulation is a pulsed DC current with pulse widths in the microsecond range and pulse rates ranging from 1 to 200 Hz, with peak amplitude of up to 1.0 amp. The Dynatron 950plus and 650plus deliver high volt utilizing a twin-peak monophasic waveform.

High volt treatments with the Dynatron 650plus and 950plus may be delivered using electrodes or an optional hand-held probe. The device provides two dedicated channels for high volt treatment (HV1 and HV2). These channels may be used to deliver two separate high volt treatments; no other modality is delivered with these dedicated channels. The device’s other output channels (1-2-3-4) remain available for other stim treatments simultaneously with the high volt treatment(s).

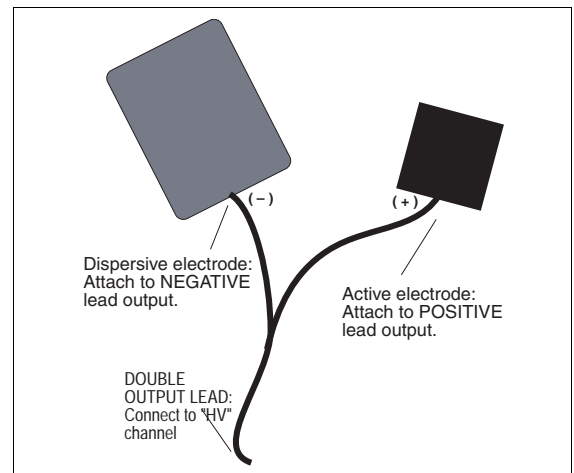

High Volt Electrode Setup

Set Up High Volt Treatment with Electrodes

This treatment setup utilizes a double-output lead with two electrodes; an active and a dispersive electrode. The size of the dispersive electrode is recommended to be double the area of the active electrode. If desired, the active output of the lead may be bifurcated to attach additional active electrodes; however, the combined total area of the active electrodes should be no more than half the area of the single passive electrode. These setups are illustrated on this page and the following page.

Press the HI VOLT key; the device automatically selects the first available high volt channel (HV1 or HV2). Connect one lead with two output connections to the HV channel. It is best to use a lead that is marked to show polarity. The active electrode is connected to the positive output. The dispersive electrode is connected to the output end that is marked negative. Ensure electrodes are attached correctly to ensure the polarity selected on the front panel of the device is delivered.

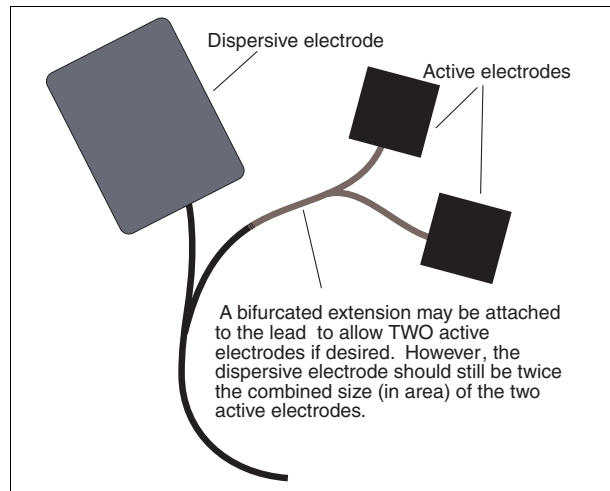

High volt electrodes with bifurcated active lead.

If desired, a bifurcated lead extension may be attached to the positive (active) end of the lead wire, allowing two active electrodes to be used. In this case, be sure the dispersive electrode is at least twice the size (in area) of the combined sizes of the active electrodes. The bifurcated lead wire extension is an optional accessory available through your Dynatronics dealer.

During the treatment current flows in one direction between the active and dispersive electrodes. Changing the polarity in the treatment parameters has the effect of reversing the direction of the current flow between electrodes. It is important to attach the active electrode to the positive output of the lead wire to ensure you are getting the selected polarity.

Set Up High Volt Treatment with Optional Probe

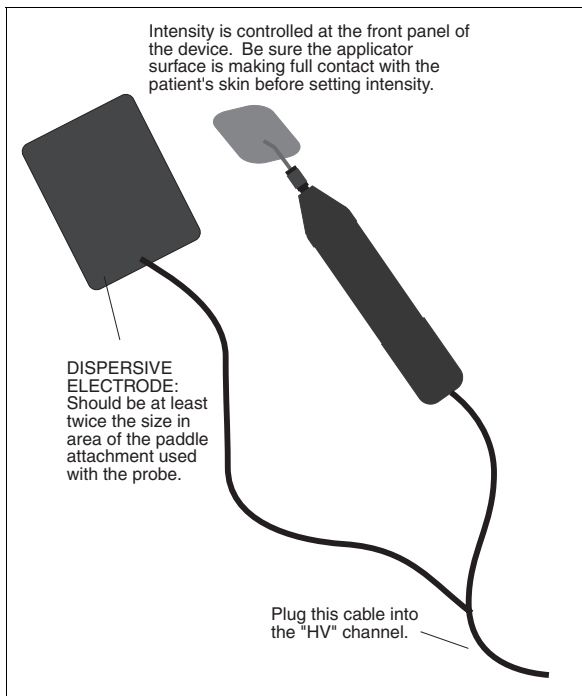

High Volt Probe Setup

This attended form of high volt therapy is delivered using a hand-held probe (optional accessory) in conjunction with a dispersive electrode. The hand-held probe is connected to the selected High Volt output jack on the front of the machine.

With a probes treatment, intensity is controlled on the front panel of the device; keep the device nearby so you can change the intensity as needed. If you select an on/off cycle (rather than continuous), you can watch the channel display; when the HV LED begins blinking, this indicates the treatment is in the off or “rest” portion of the cycle and you can position the probe at the next treatment site. By repositioning the probe only during the rest portion of the cycle, you ensure that the ramp is applied when the current again comes on—the ramp provides greater patient comfort as the current resumes. The continuous duty cycle may be uncomfortable to the patient as it provides no ramping of current when the probe is repositioned.

When setting intensity, the probe must be making contact with the patient's skin. Ensure that the patient can feel the current as you increase the intensity. Do not increase intensity for probe treatments if the patient is unable to report feeling the current.

Basic High Volt Setup

1. Press **HI VOLT**.
 - Attach lead wire or probe cable to the high volt jack selected by the device
 - Attach electrodes to patient at this time.
 - Give the remote stop cable to the patient.
2. Choose the **POLARITY** (hold down FUNCTION key and press HI VOLT key).
3. Choose the **CONTRACTION/REST** times (for electrodes treatment only).
4. Choose the **RAMP** setting.
5. Select (or set up) a **PULSE RATE RANGE** (High/Low) or set a single pulse rate.
6. Change the treatment **TIME**, if desired.
7. Raise the **INTENSITY** to the desired level (for probe treatment, make sure probe is in contact with patient skin when raising intensity).
8. Press **START**.
9. Press **STOP**, if you need to stop a treatment before its time has expired.

Detailed High Volt Setup

1. Press the **HI VOLT** key.

When you press HI VOLT, the first available high volt channel and the default settings for high voltage pulsed stimulation are automatically selected. If you have not already done so, attach leads and place electrodes on the patient now and plug the lead wire (or probe cable) into the output jack selected. See instructions at the start of this section for setting up electrodes or probes treatments. If you wish to use the default settings, you can now increase intensity to the desired level, then press START. If you wish to use other settings, do the following:

2. Choose the **POLARITY**.

Polarity is selected by holding down the FUNCTION key and pressing the HI VOLT key at the same time. Continue pressing FUNCTION-HI VOLT to select either positive (“+”) or negative (“-”) polarity or dual polarity (both “+” and “-” LEDs are on). When both are selected, the device alternates between the two, delivering each polarity for approximately 30 seconds. NOTE: Some discomfort may be felt by the patient when the polarities change. If the patient finds this setup too uncomfortable, you may consider selecting a monopolar treatment and/or reducing the intensity.

3. Choose the **CONTRACTION/REST** cycle times.

Press the toggle key one or more times to select contraction/rest cycle times. Available options include 10/10, 10/30, 10/50 and Continuous. The setting of 10/30, for example, means a 10-second contraction time followed by a 30-second rest time. The continuous duty cycle is not recommended for electrical muscle stimulation, but may be used for settings that are intended to effect other results than a muscle contraction. NOTE: For probe treatments, a NON-CONTINUOUS duty cycle is recommended. The high volt probe does not have a manual on/off control; you simply lift the probe off the skin during the rest cycle and reapply it at the next treatment site before the next contraction cycle begins.

4. Choose the **RAMP** setting.

Press the toggle key one or more times to select the ramp time. Options include .5, 1.0, 1.5, and 2.0 seconds. The ramp time is applied to both the start and to the end of the contraction and the ramp time is in addition to the contraction time itself. A ramp setting is not applied to the Continuous duty cycle.

5. Choose **HIGH or LOW** pulse rate range.

Press the HIGH/LOW toggle key one or more times to select the high range only or the low range only (this toggle key is found next to the IFC/PREMOD key). The lights next to the toggle key show you what you have selected. In a high volt treatment, High or Low only must be selected (the combined High/Low option is not available for High Volt).

Default High and Low pulse rate ranges for High Volt:

The HIGH range is 80 to 120 Hz.
The LOW range is 1 to 10 Hz.

These ranges may be changed for a single treatment if desired, or new default settings may also be saved to apply to all future treatment setups.

Change the **PULSE RATE RANGE** (optional)

You may change the pulse rate settings for the High or Low range, if desired. You may only change the pulse rate range before pressing START to begin the treatment. When you modify the settings, they will remain in effect for the duration of the treatment. If you save defaults during this treatment, the new settings you have entered become the defaults for high volt. However, if you do not save the new settings, the unit will return to the current default settings for the next treatment.

First press the TIME toggle key to select RATE. The RATE light under the TIME display becomes green and you will see the current pulse rate range settings displayed in the Time and the Power-Intensity displays as shown in the diagram below. Next, press the toggle key to select either the HIGH or the LOW range (this is found next to the IFC/PREMOD key). With RATE selected and either the HIGH or LOW range selected, you may use the up/down arrow keys to change the upper and lower limits of the range chosen. If you set both displays to the same value, the treatment will be delivered at that single pulse rate rather than sweep through a range.

Dynatron® 950plus & 650plus

The lower limit in the sweep range is shown here. In this example, this is the lower limit of the default HIGH range for the PULSE RATE.

The upper limit of the range is shown here. In this example, this is the upper limit of the default HIGH range for PULSE RATE.

Use these arrow keys to change the lower limit of the range.

Use these arrow keys to change the upper limit of the range.

Use this toggle key to select the HIGH or LOW range.

Press this toggle key to select RATE. The "Time" and "Intensity" displays then show the lower and upper settings for the PULSE RATE range you have selected (High or Low). In the example above, 80 Hz is the lower limit for the range and 120 Hz is the higher limit for the range. Use the arrow keys beside each display to change either or both of these frequencies, if desired.

NOTE: By setting both displays to the same value, you can deliver a treatment at a single PULSE RATE rather than sweep through a range. For example, set both the upper and the lower limits at "100" for a 100 Hz treatment.

When you are finished setting the pulse rate range, press the Time toggle key to return to the Time display. After 10 seconds with no key presses, the Time display automatically returns.

6. Change the treatment **TIME**, if desired.

If the Time LED is not lighted, press the Time toggle key to select Time. The default time is displayed. Use the Time arrow keys to increase or decrease the treatment time. The Time toggle key may also be used to select RATE if you wish to modify the pulse rate settings as explained in step 5 above.

7. Raise the **INTENSITY** to the desired level.

Remember, when you increase intensity, current to the patient begins. Therefore, you should proceed to press **START** immediately after setting the intensity to begin the treatment timer.

Never use High Volt to treat any conditions which contribute to loss of sensation, and never use High Volt to treat an area where the patient cannot feel the electrical stimulation.

8. Press **START**.

Be sure to press Start to begin both electrodes or probes treatments. When you press start, the treatment timer begins counting down. If you fail to set the intensity before pressing **START**, the intensity display will begin flashing, and you will be unable to start the treatment until you set the intensity.

NOTE: SAVE DEFAULTS. If the treatment you have just set up is the most common High Volt setup you use, you can save the treatment parameters as new defaults for your own machine. After setting up the treatment, simply press and hold the START key for two seconds. At the end of two seconds, you will hear a beep indicating the treatment parameters have been saved. The next time you select this modality, these parameters are selected automatically.

9. **MODIFY** settings.

While the High Volt treatment is in progress, you can modify the following treatment parameters.

- Use the toggle keys to select a different contraction/rest cycle.
- Use the toggle keys to select a different ramp time.
- Use the Function-Hi Volt keys to change the polarity.
- Use the Time arrow keys to increase or decrease the treatment time.
- Use the Power-Intensity arrow keys to increase or decrease the intensity.

You can not change from High to Low (or the reverse) once a treatment has started.

10. Press **STOP**, if it is necessary to end the treatment before the treatment time has expired.

When the treatment time has elapsed, current to the patient is stopped and a tone sounds notifying you of the treatment end. Treatments in progress may be stopped at any time using one of the following methods.

STOP: Press this key to stop treatment at all channels. You may prefer to stop treatment at one channel only (see explanation below).

REMOTE STOP: During “unattended therapy,” a patient stop button is provided to allow the patient to stop treatment. The remote cord should be plugged into the machine prior to starting the treatment. When the remote stop button is pressed, all output from the device is stopped, time is set to zero, and a tone sounds briefly.

STOP ONE TREATMENT ONLY: If you have more than one treatment in progress, you can stop one treatment by either of the following methods. First, press the channel toggle key to select the channel to be stopped (that channel’s light is green when selected).

FUNCTION-STOP. Press and hold the FUNCTION key and press STOP.

REDUCE THE TREATMENT TIME TO ZERO. Press the Time down arrow until the Time display reaches zero. The device beeps when the time reaches zero.

The output at the selected channel is stopped, and the device then displays the parameters for the next treatment that remains in progress (if any).

High Volt Default Settings

The following default settings are set by the manufacturer and are selected when you select High Volt. You may change these defaults to your own preferred settings. See “Setting Defaults” in this manual.

- Continuous on cycle
- Treatment time: 10 minutes
- Ramp up and down time: .5 sec.
- Polarity: Negative
- Pulse Rate: High Range
 - Default High Range: 80-120 Hz
 - Default Low Range: 1-10 Hz
 - Available Range: 1-200 Hz

Microcurrent Instructions

WARNING

- **NEVER** turn the power on or off while the unit is connected to the patient.
- **Always STOP** a treatment before removing or attaching electrodes or leads.
- **Never use worn or damaged leads or electrodes as these may result in injury to the patient.**
- **See “Contraindications, Warnings, and Precautions” in this manual before administering a treatment to a patient.**

Microcurrent treatments may be delivered using either electrodes or optional probes. If you are not familiar with the operation of the probes see “How to Use Microcurrent Probes” later in this section. For treatment with electrodes, plug one lead into the Channel 1 jack, and place the two electrodes on the patient before setting up the treatment. For treatment with probes, plug the microcurrent probe into its own output jack on the left side of the device.

During the microcurrent treatment the current is delivered to both Channel 1 and to the probe outputs simultaneously. Therefore, Channel 1 is unavailable for any other treatment while any microcurrent treatment is in progress (including during probes treatments).

Basic Microcurrent Setup

1. Press the **MICRO** key.
2. Choose treatment channel, **CH 1** for electrodes or **MICRO** for probes, and attach the lead and electrodes or the probe cable to the selected output channel.
3. Choose the **POLARITY** (press FUNCTION-MICRO).
4. For electrode treatments only, change the **TIME**, if desired.
5. Change the **FREQUENCY**, if desired.
6. Change the **INTENSITY** setting, if desired.
7. Press **START**.
8. Press **MICRO** again to turn **AUDIBLE TONE** on/off, as desired.
9. Press **STOP** if you need to stop a treatment before its time has expired.

Microcurrent Treatment Time

- All probe treatments are manual, and a treatment time is not set. During the probe treatment, the timer will start at zero and count UP in SECONDS when current is on, and will return to zero when current is stopped. You must press START to begin the treatment, then press the button on the probe to start and stop delivery of current. Press STOP or Function-Stop at the end of a probe treatment.
- Electrode treatments are timed, and a treatment time in MINUTES is entered at the start of the treatment. The timer counts DOWN for electrode treatments.

Detailed Microcurrent Setup

Before setting up a microcurrent treatment with electrodes, attach a lead wire with two electrodes to Channel 1, or, for a probes treatment, connect the optional probe to the MICRO PROBE output on the left side of the device. During a microcurrent treatment, the microcurrent is delivered to both probes and Channel 1 outputs simultaneously.

1. Press the **MICRO** key.

When you press the MICRO key, the default settings are automatically selected. If you wish to use the default settings, you can now simply press START. If you wish to use other settings, do the following:

2. Choose the output desired **CH1** (for electrodes treatment) or **MICRO** (for probes treatment).

The default for this option is treatment with electrodes. Press the channel toggle key to select MICRO for treatment using the optional probe, if desired.

3. Choose **POLARITY**.

Press and hold the FUNCTION key and press the MICRO key at the same time to select the desired polarity. Repeat this one or more times until the desired polarity is selected. Press once to select positive (“+”), press again to select negative (“-”), and press again to select dual polarity (both “+” and “-” LEDs are lighted). When both positive and negative are selected, the resulting bipolar waveform includes both a positive and a negative phase.

4. For electrode treatments only, change the **TIME**, if desired.

To change the time, use the Time up/down arrow keys to change the treatment time. Be sure that Time is selected when you make this change; the indicator light shows which option is selected. The toggle key allows you to choose the desired option.

For probes treatment, the Time display shows zero until you begin treating. When you press the button on the probe, the device beeps once and the timer then counts up from zero (in seconds) allowing you to time the delivery of current to each treatment site. When you press the button on the probe to stop the current, the device beeps twice and the timer returns to zero.

5. Change **FREQUENCY**, if desired.

To change the frequency, use the Time toggle key to select **FREQ**, then use the Time up/down arrow keys to change the frequency. You can press the Time toggle key again to return to the Time display, if desired. However, if you make no key presses for 10 seconds, the display automatically returns to the Time display.

6. Change the **INTENSITY** setting.

This setting is displayed in micro amperes in the Power-Intensity display. Use the up/down arrow keys to change the intensity.

For Electrodes treatments, the CHANNEL 1 indicator light is green. For probes treatments the MICRO channel light is green and the Channel 1 light is yellow. Changes you make will affect output to both the probe and Channel 1.

7. Press **START**.

For electrode treatments, when you press **START**, the treatment timer begins counting down and stim is delivered through Channel 1.

For probe treatments, after pressing Start you must press and release the button on the probe to activate current through the probe; the device beeps once to signal that current delivery has started (it is not necessary to hold the button down while treating). The treatment timer begins counting up in seconds from zero to provide a convenient means of timing the delivery of current at a given point. Press and release the button again to stop the current through the probe; the treatment timer returns to zero and the device beeps twice to signal that current delivery has stopped. Continue starting and stopping current delivery in this way.

NOTE: SAVE DEFAULTS. If the treatment you have just set up is the most common microcurrent setup you use, you can save the treatment parameters as new defaults for your own machine. After setting up the treatment, simply press and hold the **START** key for two seconds. At the end of two seconds, you will hear a beep indicating the treatment parameters have been saved. The next time you select the **MICRO** modality, these parameters are selected automatically.

Separate default parameters may be saved for both treatments with electrodes and with probes. See “Setting Defaults” in this manual for further instructions.

8. Turn **AUDIBLE TONE** on/off, and/or adjust volume.

The audible tone allows you to monitor conductance, if desired. As conductance increases (as resistance is decreased), the tone becomes higher in pitch.

The audible tone is defaulted to **ON** for probes treatments and **OFF** for electrodes treatments, but may be changed. After the microcurrent treatment has started the **MICRO** key acts as a toggle key to turn the tone on and off. Press **MICRO** to turn the tone on or off.

You may also adjust the tone volume after the treatment has started. To adjust the volume, **PRESS** and **HOLD** the **FUNCTION** key and at the same time use the Power-Intensity arrow keys to raise or lower the volume until a comfortable volume setting is found. The Power-Intensity display will temporarily show an incremental value

representing the volume selection. You must continue holding the FUNCTION key down while adjusting the volume. When you release the FUNCTION key, the Power-Intensity display returns to its normal display.

9. **MODIFY** a treatment in progress.

While the treatment is in progress, you can modify the treatment parameters.

- Press the FUNCTION-MICRO key to select a different polarity.
- Use the Time toggle key to select TIME then use the Time arrow keys to increase or decrease the treatment time.
- Use the Time toggle key to select FREQ, then use the Time arrow keys to increase or decrease the frequency.
- Use the Power-Intensity arrow keys to increase or decrease the intensity.

10. Press **STOP**, if it is necessary to end the treatment before the treatment time has expired.

When the treatment time has elapsed, current to the patient is stopped and a tone sounds notifying you of the treatment end. Treatments in progress may be stopped at any time using one of the following methods.

STOP: Press this key to stop treatment at all channels. You may prefer to stop treatment at one channel only (see explanation below).

STOP ONE TREATMENT ONLY: If you have more than one treatment in progress, you can stop one treatment by either of the following methods. First, press the channel toggle key to select the channel to be stopped (that channel's light is green when selected).

FUNCTION-STOP. Press and hold the FUNCTION key and press STOP.

REDUCE THE TREATMENT TIME TO ZERO. Press the Time down arrow until the Time display reaches zero. The device beeps when the time reaches zero.

The output at the selected channel is stopped, and the device then displays the parameters for the next treatment that remains in progress (if any).

Remote Stop Cable With Microcurrent

Even though microcurrent is a very low voltage therapy, you may allow the patient to hold the Remote Stop cable during an unattended treatment if desired. If the button on the Remote Stop cable is pressed during any microcurrent treatment, the treatment time and output are stopped, and the timer returns to zero.

Audio Tone

The audio tone allows monitoring of conductivity throughout the microcurrent treatment to ensure adequate contact between the patient's skin and the probe or electrodes for purposes of patient safety and comfort. The unit senses conductivity of the connection as soon as current is applied, and continues throughout the treatment.

Microcurrent Default Settings

The following default settings are set by the manufacturer and are selected when you press Micro. You may change these defaults to your own preferred settings. See "Setting Defaults" in this manual.

The Microcurrent treatment setup with electrodes is the default, and the following defaults are also selected:

- Bipolar wave
- .3 Hz frequency
- 50 μ A intensity
- Time: 20 minutes, counts down
- Audible Tone: Off

If Probe treatment is selected, the following defaults are automatically selected:

- Negative unipolar wave
- 4 Hz frequency
- 300 μ A intensity
- Time: zero, counts up
- Audible Tone: On

Available Ranges:

- Frequency: Between .1 and 500 Hz
- Intensity: Between 10 and 990 microamps (in increments of 10 μ A).

The ranges of .1 to 500 Hz frequency and between 10 and 990 micro amperes intensity are available for setting up both electrodes and probes treatments. For guidance in selecting the appropriate frequency and intensity for a given probes or electrodes treatment, consult published medical literature.

How To Use Microcurrent Probes

(The microcurrent active and ground probes are optional accessories available from Dynatronics) For the active and ground probe, use the end of a cotton swab (such as a Q-Tip®) inserted into the end of the probe. Cut the end of the swab to a short length. The cotton must touch the metal ring at the tip of the probe. Use a conductive electrolyte spray or water to wet the cotton swab before treating. If the cotton dries out during treatment, conductance may become erratic. Rewet the cotton, if needed.

Active Probe: To deliver the current to the patient through the active probe, first set up the probe treatment and press Start. Then hold the probe as you would hold a pencil, and press the button near the tip of the probe to start delivery of current. The active probe should touch the patient's skin at the treatment site, and the ground probe should touch the patient's skin elsewhere near the treatment site. This completes the circuit and delivers current to the

patient. You do not need to hold the button down. Once you have pressed and released the button, the current is delivered until you press and release the button again to stop the current. The unit beeps once when you press the button to start the current, and beeps twice when you press the button to stop the current.

While you are delivering current, the treatment timer counts up in seconds from zero. When the current is stopped, the timer returns to zero. Press the button again to commence the next time sequence. Continue in this way until treatment is completed.

Ground Probe: The ground probe is used to complete the circuit to allow flow of current through patient tissue. The ground probe should touch the patient's skin at any location away from the treatment point. As an alternative, you may also use a dispersive electrode as explained below. With the ground electrode you do not need to hold the ground probe in your hand during treatment. This is particularly convenient when treating in several different places around one point.

Ground Electrode: You can use an electrode in place of the ground probe. Just unplug the ground probe from its cable, attach a banana to pin adapter to the cable (this optional adapter is available from your Dynatronics dealer), then attach an electrode to the pin. Place the electrode on the patient at a site where it will not interfere with placement of the active probe during treatment.

TREAT: Press and release the button on the active probe to start current delivery. The unit beeps once to indicate current delivery has started. When the active probe and a ground probe touch the patient's skin, the current is delivered to the patient. Observe conductance by listening to the audio tone.

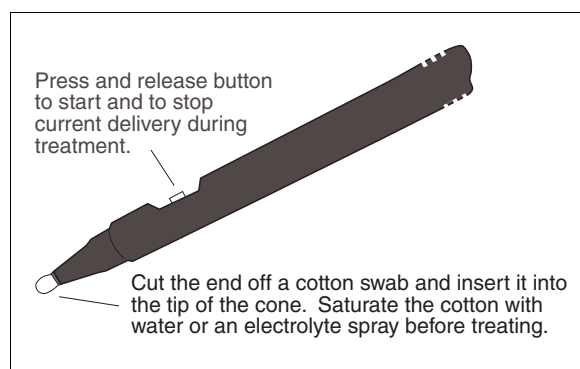

TEST Mode: Press and release the button again to stop delivery of current. The unit beeps twice to let you know current delivery has stopped. The probe is now in "Test" mode allowing you to continue monitoring conductance at any point desired. When the probe touches the patient's skin, conductance continues to be measured and the audio tone is produced. Press and release the button when you wish to return to the Treat mode.

NOTE: In Test mode during a microcurrent treatment, a small amount of current is delivered to allow an impedance reading to be taken in order to show conductance. The current delivered during Test mode is either 25 micro amperes or the micro amperage setting for the treatment itself, whichever is less. For purposes of this measurement, current is delivered in pulses of approximately 20 ms.

Ultrasound Instructions

The following Ultrasound Instructions are for DYNATRON 950plus USERS ONLY.
The Dynatron 650plus model does not offer the ultrasound feature.

WARNING

- **ALWAYS** keep the applicator soundhead in constant motion.
- **ALWAYS** keep the soundhead properly coupled to the patient's skin or submerged under water when intensity is turned on.
- Use ample conductive gel to ensure good coupling throughout the treatment. If needed, apply additional gel during the treatment.
- See the section of this manual entitled "Contraindications, Warnings, and Precautions" for ultrasound treatments.
- Be alert for any sign of periosteal (bone) pain.
- Be sure to read all instructions for operation before treating a patient.
- Do not drop the soundhead on hard surfaces, do not cool the soundhead with ice water or ice packs, do not allow the soundhead to overheat repeatedly, and do not hold the soundhead in the air while a treatment is running. All of these conditions are likely to damage the soundhead crystal and/or to stress electronic components in the device.
- **CAUTION:** Use of controls or adjustments or performance of procedures other than those specified herein may result in hazardous exposure to ultrasonic energy.

Make sure a soundhead is firmly plugged into the device before turning the device on. When changing to a different size soundhead, turn the machine off first, remove the soundhead, plug in the desired soundhead, then turn the machine on again.

NOTE: The patient Remote Stop cable is not necessary during ultrasound treatments since this is always an attended therapy. However, if for any reason this might be preferred, the Remote Stop cable may be given to the patient for use during Combo treatments. If the Remote Stop button is pressed during a Combo treatment, both the stim and the ultrasound outputs are stopped and the timer is set to zero.

Soundhead Warming

When the device is powered on, it automatically enters a default head warming mode. During this mode the soundhead should remain in its holder as a small amount of ultrasound output is emitted from the soundhead (.1 Wcm²). The warming feature turns on and off automatically as needed to maintain a comfortable soundhead temperature. The soundhead warming mode is automatically stopped during a treatment, and resumes automatically as needed after a treatment has ended.

Turn Soundhead Warming Off / On

If you do not wish to use the head warming feature, you can turn the feature off with the following key press. The head warming setting is saved and will apply to the device whenever it is used until you change the setting again. These key presses are only necessary if you want to change the current state of head warming.

- Press and hold the **FUNCTION** while pressing the **SOUND** key to turn soundhead warming off or to turn it on again. The device will beep and the Time display will show the selection made as follows:
 - HD 1 = Head warming on
 - HD 0 = Head warming off
- Press **STOP** after selecting the desired setting.

Basic Ultrasound Setup

1. Press the **SOUND / COMBO** key once to select **SOUND**.
2. Choose the **FREQUENCY**.
3. Choose the **DUTY CYCLE**.
4. Change the treatment **TIME**, if desired.
5. Raise **POWER**.
6. Press **START**.
7. Press **STOP** if you need to stop a treatment before its time has expired.

Detailed Ultrasound Setup

1. Press the **SOUND / COMBO** key once.

When you press the **SOUND/COMBO** key once, the **SOUND LED** is lighted, and the ultrasound treatment default settings are automatically selected. If you wish to use the default settings, increase the power, then press **START**. If you wish to use other settings, do the following:

2. Choose the **FREQUENCY**.

Press the frequency toggle key one or more times to choose 1, 2, or 3 MHz. Any one of the three frequencies may be selected with the 2 cm², 5 cm² and the 10 cm² soundheads. The 1 cm² soundhead offers 2 and 3 MHz.

3. Choose the **DUTY CYCLE**.

Press the duty cycle toggle key one or more times to select the desired duty cycle. Available options include 10 percent, 20 percent, 50 percent, and Continuous duty cycle.

4. Change the treatment **TIME**, if desired.

Use the Time up/down arrow keys to change the treatment time, if needed.

5. Raise **POWER**.

Use the Power-Intensity up/down arrow keys to increase the power to the desired setting. For patient safety and comfort, it is recommended that you start with .1 w/cm², then increase power to the desired level after the treatment begins. Valid ranges are from .1 to 2.0 w/cm² (exceptions: valid ranges when using a 10 cm² head at 3 MHz are from .1 to 1.0 w/cm²; valid ranges when using a 1 cm² head are from .1 to 1.5 w/cm²).

NOTE: You may view the power display in either WATTS or W/cm². The default setting for the device is W/cm². This option is explained in detail later in this section.

6. Press **START**.

When you press **START**, the treatment timer begins counting down and output is delivered to the soundhead. If you fail to set the power before pressing **START**, the intensity display will begin flashing, and you will be unable to start the treatment until you set the power.

Be sure to use a coupling agent such as gel or lotion, and maintain good coupling throughout the treatment (see “Ultrasound Usage Cautions” in this manual). Do not hold the soundhead in the air, as this will cause the soundhead to overheat. The device provides coupling sensing to help you know when coupling is not adequate. This feature is discussed later in this section.

SAVE DEFAULTS. If the treatment you have just set up is the most common ultrasound setup you use, you can save the treatment parameters as new defaults for your own machine. After setting up the treatment, simply press and hold the **START** key for two seconds. At the end of two seconds, you will hear a beep indicating the treatment parameters have been saved. The next time you select the **SOUND** modality, these parameters are selected automatically.

7. **MODIFY** a treatment in progress, if desired.

While the treatment is in progress, you can modify the following treatment parameters.

- Use the frequency toggle key to select a different frequency.
- Use the duty cycle toggle key to select a different duty cycle,
- Use the Time arrow keys to increase or decrease the treatment time.
- Use the Power-Intensity arrow keys to increase or decrease the power.
- Press and hold the **PAUSE/FUNCTION** key for two seconds to change display from w/cm² to Watts or reverse.

8. Temporarily **PAUSE** a treatment, if necessary, while the treatment is in progress.

To temporarily pause the treatment, press the **PAUSE** key. This stops the ultrasound output from the soundhead and pauses the treatment timer without ending the treatment. While a treatment is paused, the light on the Pause key is lighted and the ultrasound output to the soundhead is stopped. To resume the treatment, either press **START** or press **PAUSE** again. Output then resumes and the treatment timer starts from where it was paused.

NOTE: During a combo treatment, THE STIM OUTPUT OF THE TREATMENT IS NOT PAUSED when the PAUSE key is pressed, although the ultrasound output is stopped and the treatment timer is paused.

9. Press **STOP** if you need to stop a treatment before its time has expired.

When the treatment time for a treatment has elapsed, the output to the soundhead is stopped and a tone sounds notifying you of the treatment end.

STOP ONE TREATMENT ONLY: If you have more than one treatment in progress, you can stop one treatment by either of the following methods. First, press the channel toggle key to select the channel to be stopped (that channel's light is green when selected).

FUNCTION-STOP. Press and hold the FUNCTION key and press STOP.

REDUCE THE TREATMENT TIME TO ZERO. Press the Time down arrow until the Time display reaches zero. The device beeps when the time reaches zero.

The output at the selected channel is stopped, and the device then displays the parameters for the next treatment that remains in progress (if any).

Ultrasound Default Settings

The following default settings are set by the manufacturer and are selected when you press the Sound key. You may change these defaults to your own preferred settings. See "Setting Defaults" in this manual.

- 1 MHz for 2, 5, and 10cm² soundheads, and 2 MHz for the 1cm² soundhead
- Continuous
- Time: 5 minutes

Patient Coupling

The Dynatron 950plus provides the feature of patient coupling detection which senses the coupling between the soundhead and the patient to ensure proper delivery of the ultrasonic therapy. The coupling bar graph described on the following page provides a graphical representation of coupling status during a treatment.

Coupling (contact between the soundhead and the treatment site) may be provided either via a coupling agent such as a gel or lotion, or in water, as with underwater treatments. Any material used as a coupling agent must be highly conductive of ultrasonic waves. Air is a very poor conductor of ultrasonic waves. Therefore, avoid allowing any air between the soundhead and the treatment area.

During the treatment the soundhead should be moved continuously covering an area approximately twice the size of the soundhead in area. The full surface of the soundhead should maintain contact with the patient's skin (except with underwater treatments).

Poor Coupling

If all or part of the soundhead is not touching the patient, coupling may not be adequate and the patient will not receive the intended dosage of the ultrasonic wave. Poor coupling, if allowed to continue, can also result in increased temperature of the soundhead. Do not hold the soundhead in the air while a treatment is running as this may damage the soundhead crystal and/or stress electronic components in the device.

Ultrasound Coupling Bar Graph

This feature for models having software greater than Rev. 1.01 only (see Page 2).

During an ultrasound treatment, you can press SOUND-TARGET (press both keys at once) to display a bar graph to indicate coupling. Coupling sensing indicates whether adequate contact is being maintained between the soundhead and the patient's skin. The bar graph uses the eight segments in the top half of the display, with eight lighted segments indicating best conductance, and one lighted segment indicating poorest conductance. In the illustration below, eight of the eight segments are lighted indicating good coupling.

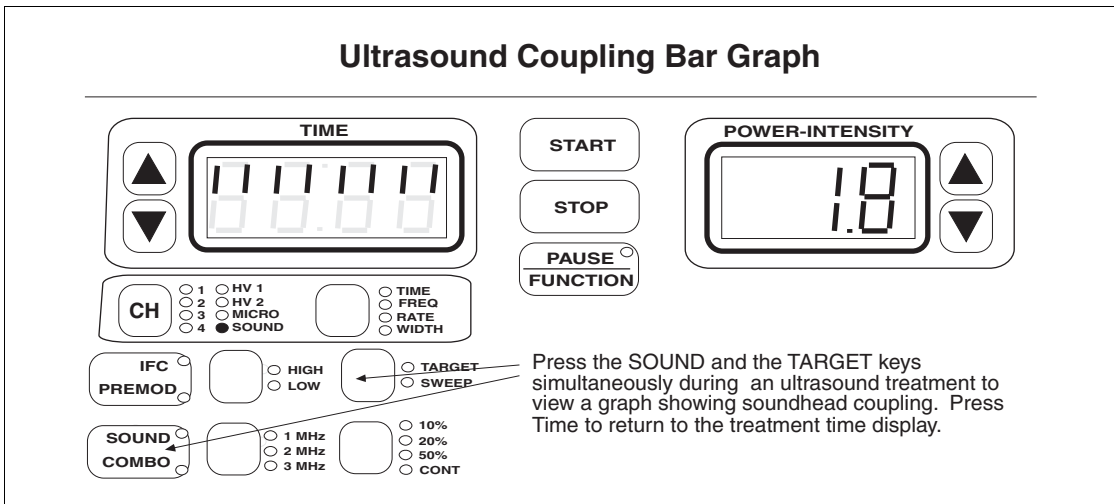

Coupling Bar Graph. Eight lighted segments indicate good coupling between patient and soundhead.

To correct poor coupling ensure you are using an adequate amount of ultrasound conductive gel, and the face of the soundhead is making full contact with the patient's skin.

Press TIME to redisplay the treatment time. Treatment time continues counting down while the bar graph is displayed unless the treatment is paused for any reason.

Disable the Coupling Sensing. You can disable the coupling sensing capability of the device if desired. While the treatment is running, press the FUNCTION and the Power/Intensity DOWN ARROW keys at the same time. The Time display will very briefly display the new setting as follows:

- CP 1 = Coupling on
- CP 0 = Coupling off

After a second the display returns to the treatment time display. Repeat this key sequence to change the default setting again, if desired. NOTE: In changing the coupling setting, you

may inadvertently PAUSE the treatment (the PAUSE LED will be lighted). Just press PAUSE again to resume the treatment.

NOTE: The coupling sensing bar graph may be viewed both during sound treatments and during combo treatments. Changes to the treatment settings including frequency, duty cycle, and size of soundhead will cause some variance in the graph. This bar graph is not available for 1 cm² soundheads.

Head Temperature Hot

If poor coupling is allowed to continue, the temperature of the soundhead rises and the patient does not receive the full ultrasonic output. The Dynatron 950plus continuously measures the temperature of the soundhead to ensure both that the patient is receiving the optimal treatment and that the soundhead crystal is protected from overheating.

If the soundhead temperature approaches the maximum level, the POWER display will begin flashing.

For devices having software Rev. prior to 1.02:

If the temperature reaches the maximum level allowed, the treatment is automatically PAUSED, the output power is stopped, the treatment time stops counting down, both the Time and Power displays flash continuously. The soundhead must then be cooled down before the treatment can resume.

For devices having software greater than Rev. 1.01.

With software revisions greater than Rev. 1.01, the Time and Power displays do not flash, but the Time display shows the error message "HOT" (see Page 2 of this manual for instructions on determining the revision level of your device). When this condition occurs, the treatment timer is paused, output is stopped, and the soundhead must be cooled down before the treatment can resume. Once the soundhead is cooled, press Pause or Start to resume the treatment.

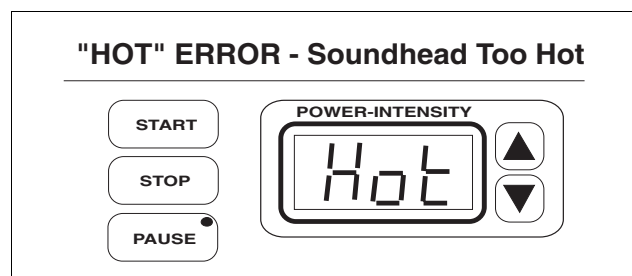

"HOT" Error. During an ultrasound treatment, if the soundhead becomes too hot, the "HOT" error message is displayed and the treatment is paused for the soundhead to be cooled.

The soundhead will cool slowly if placed in the soundhead holder or if held exposed to the air. Larger soundheads take longer to cool than smaller heads. To resume the treatment right away, you can place the soundhead in cool/room temperature water to cool the head more quickly.

NEVER USE ICE OR ICE PACKS TO COOL THE SOUNDHEADS as this is likely to cause thermal shock to the electronic components of the soundhead and may necessitate a costly repair. Heads damaged by thermal shock are not covered by the warranty.

When the temperature is again satisfactory, press the START key to resume the treatment; output power resumes, the displays return to its normal state, and the timer resumes. While the soundhead is still too hot, the device will not allow you to resume the treatment.

To prevent overheating of the soundhead, maintain good coupling throughout the treatment. For direct coupling, you may need to apply more conductive gel or lotion during the treatment to achieve better coupling.

You can reduce the power during the treatment if you are treating an area where it is difficult to obtain good coupling.

Head Temperature Bar Graph

During an ultrasound treatment, you can view a graph showing the relative soundhead temperature by pressing SOUND and the HI/LO keys simultaneously. As shown in the illustration below, the Time display shows the letter “H” followed by a bar graph with from 1 to 6 segments lighted. The more segments displayed, the hotter the soundhead. This display does not provide an actual temperature reading, but does give a visual indication when the soundhead is becoming too hot. To return to the treatment time display, press the TIME key.

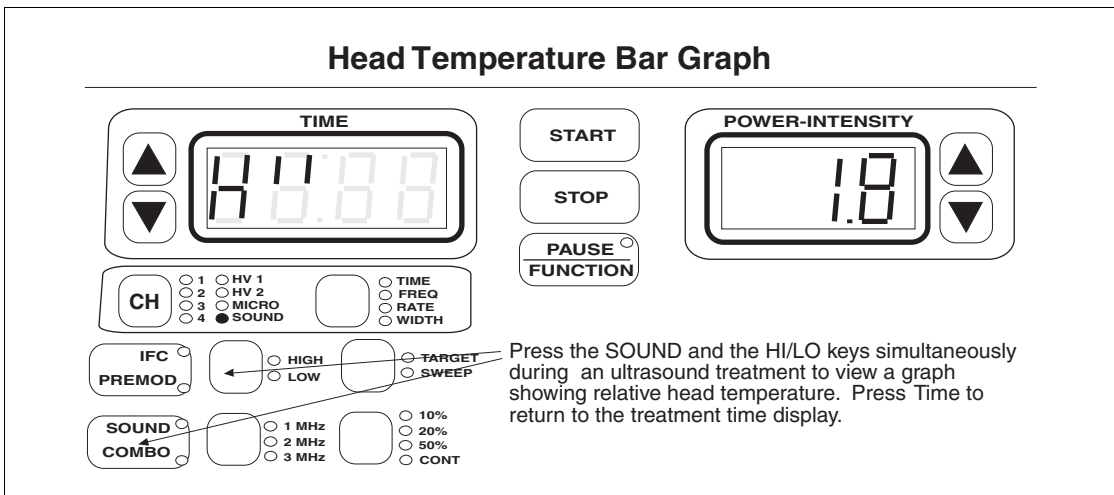

Temperature Bar Graph. During an ultrasound treatment press SOUND and the HI-LO keys simultaneously to view a bar graph representing the soundhead temperature.

Display Watts or W/cm²

Power for the Dynatron 950plus may be displayed as WATTS or W/cm². The default setting for power is W/cm², but you may select the display you prefer at any time before or during a treatment.

- To change the power display, press the PAUSE/FUNCTION key and hold it down for two seconds. To change back, again press and hold the PAUSE/FUNCTION key **for two seconds**. The device will beep to indicate you have changed the display. Note that if you are in a treatment when you press and hold the Pause key, the treatment may be paused (the Pause LED is on) and you should press Pause briefly again to turn off the Pause LED and resume the treatment.

- The default power display is W/cm^2 . If you change the display to WATTS during use, the machine reverts to the W/cm^2 display when the machine is turned off and on again. However, if you save ultrasound default settings while using the WATTS display, the WATTS display will become the default display for your machine.
- You can tell when you have selected WATTS display by the decimal in the display window.
 - A steadily-lighted decimal means the power is displayed in W/cm^2 .
 - A blinking decimal means the power is displayed in WATTS.

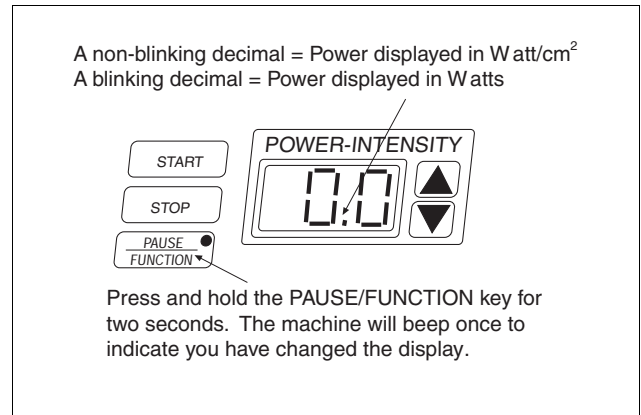

Dynatron 950plus Power Display. You can view power in either W/cm^2 or WATTS.

Combination Therapy Instructions

The following combination therapy instructions are for DYNATRON 950plus USERS ONLY. The Dynatron 650plus does not offer the ultrasound feature.

WARNING

- **DO NOT use combination therapy for underwater treatment. Placing active electrodes under water poses a serious hazard to the patient!**
- **Use VERY LOW STIM INTENSITY for combo treatments.**
- **Remember to observe all contraindications, warnings, precautions, and usage cautions for BOTH ultrasound and electrical stimulation therapy when performing combination therapy.**
- **Since electrical current travels between the electrode and the soundhead during combo treatment, the electrode should be placed in proximity with the treatment area. Do not place the electrode and soundhead in positions that will cause current to pass through contraindicated areas.**
- **Avoid removing the soundhead from the skin surface during “Stim through Soundhead” treatments, as this may cause increased current density momentarily which may be uncomfortable to the patient. The soundhead should remain in full contact of the skin until current output is stopped.**
- **Be alert for any sign of periosteal (bone) pain.**

Comboplus™

Dynatronics’ new Comboplus feature means you have almost unlimited options in setting up a combination treatment with the Dynatron 950plus. Now you can

- Combine an ultrasound treatment **with any electrotherapy modality** provided by this device (single-channel options only; Premodulated, Biphasic, Russian, High Volt, or Microcurrent).
- Set up a combination treatment **using any of the six electrotherapy output jacks.** This means combination therapy is no longer restricted to just one channel—any channel may be used

A special “combo” lead wire is provided in the standard accessories for this device to accommodate the Comboplus feature. This lead wire is plugged into the selected stim jack; then the banana end of the lead is connected to the stim input jack on the back of the device, and the pin end of the lead is connected to an electrode to be placed on the patient. The following illustration shows one example of a combination therapy setup. Since any of the six channels may be used with combination therapy, it is important to note the channel selected by the device during setup and connect the lead wire to the correct channel before setting intensity for the treatment.

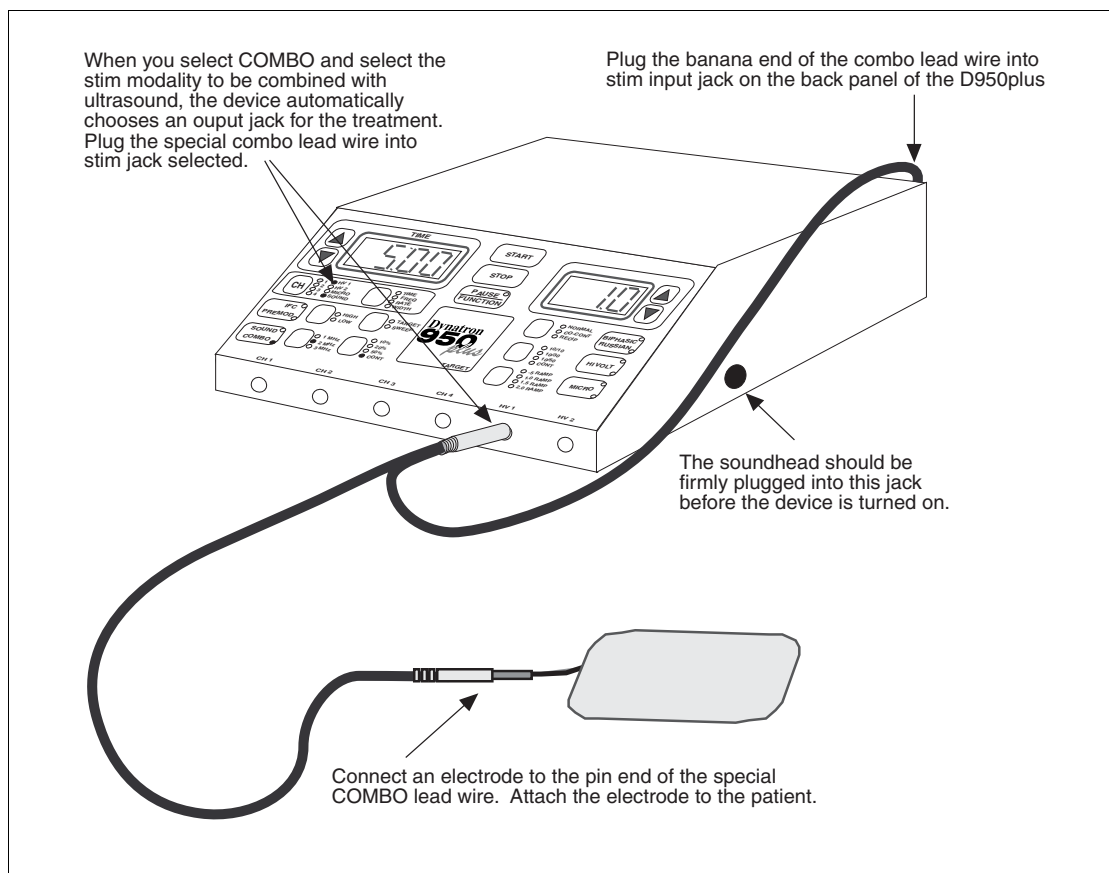

Special Combo Lead Wire. Stereo jack attaches to any of the six channels. Banana end plugs into the stim input on the back of the device. The pin end of the lead wire attaches to an electrode.

Stim Through the Soundhead

With combination therapy, the soundhead is used in place of one electrode for a stim treatment; and electrotherapy current is delivered through the soundhead. This means that for a normal 2-electrode stim treatment therapy, you would place one electrode on the patient and use the soundhead as the second electrode site to complete the setup. A patient lead wire designed to accommodate this setup is included in the Dynatron 950plus standard accessory package.

During the treatment, the stim current passes between the soundhead and the other electrode. At the same time ultrasonic waves are introduced into patient tissue through the soundhead. Avoid touching the electrode with the soundhead during the treatment, keep the soundhead in contact with the patient's skin at all times, and **keep the intensity low for the stim current.**

When setting up a combination treatment, observe all contraindications, warnings, and precautions for both therapies to be used.

REMEMBER: Use very low stim intensity for all combo treatments!

Combination Therapy Setup

In order to set up a combo treatment, you must be familiar with setup instructions for both the electrotherapy modality to be used and ultrasound as explained earlier in this manual. Also remember:

- When a channel's LED is green, the treatment parameters for that output are displayed. Any changes you make to the parameters will affect that channel only.
- When an indicator light is yellow, the channel is active, but its parameters are not being displayed and may not be modified at this time. You must first press the channel toggle key (CH) to select the channel—its light will then become green and modifications are allowed.

Since ultrasound and stim share the Time and Power-Intensity displays during a combination treatment, you will need to observe the indicator lights when setting up or changing treatment parameters. You may toggle between the stim and sound channel using the channel toggle key.

You may set up either the ultrasound or the stim treatment first. The Channel Toggle key allows you to switch between channels to select the treatment type to be set up first. When the Sound indicator light is green, you can set up ultrasound parameters. When the stim channel light is green, you can set up the electrotherapy parameters. The treatment timer does not begin until you press Start after both modalities have been set up.

1. Press the SOUND/COMBO key twice to select COMBO. If desired, you may now set up the Sound portion of the treatment. Then toggle to the stim channel by pressing START or the channel toggle key; or press the appropriate key to select the desired electrotherapy modality (Premod, Biphasic, Russian, High Volt, or Microcurrent). The front panel of the device shows the following default selections:
 - The COMBO LED is lit.
 - The selected modality key is lit.
 - The first available channel for the stim therapy chosen is indicated by a GREEN light. The SOUND channel light is YELLOW.
 - The TIME display shows 5 minutes (or other time if you have changed this default).
2. Attach the lead wire to channel jack that corresponds with the channel light for the modality chosen. Apply the stim electrode to the patient now. Apply conductive gel to the ultrasound treatment site now.

Set up Biphasic, Russian, Premod, High Volt or Microcurrent:

1. The stim channel light must be green before setting up the stim treatment. Press the Channel Toggle key, if needed, to select the stim channel. (NOTE: Combination with microcurrent requires Channel 1 to be used.)
2. If the modality you wish to use is not already selected (Premod, Russian, Biphasic, High Volt, or Microcurrent) press that modality key now. When a modality key is pressed, the LED on that key is lighted while the COMBO LED remains lighted as well. Again, make

sure the combo lead is plugged into the correct output jack for the stim modality you have selected.

3. Enter treatment parameters for the selected modality as instructed earlier in this manual.
4. Place the soundhead at the treatment site making good contact with the skin (be sure you have applied conductive gel first). Raise the stim intensity to the desired level. If the soundhead is in proper position and coupling is good, the patient will feel the current. If the patient does not feel the current, check to be sure coupling is good and make sure you have used ample conductive gel.

KEEP THE STIM INTENSITY LOW!

Set up Sound:

Continue to keep the soundhead in contact with patient skin during ultrasound setup.

1. The Sound indicator light must be green before setting up ultrasound parameters. Press the Channel Toggle key, if needed, to select SOUND.
2. Enter ultrasound parameters as described in “Ultrasound Instructions” earlier in this manual.

After both modalities are set up:

Continue to ensure the soundhead is making contact with the patient’s skin.

1. Press START.

If you fail to set the intensity or ultrasound power before pressing START, the Power-Intensity display will begin flashing, and you will be unable to start the treatment until you set the intensity. Remember that you must set both the intensity for the stim treatment and the power for the sound treatment.

NOTE: SAVE DEFAULTS. The default combination treatment includes ultrasound with premodulated treatment for five minutes. The stim treatment parameters are derived from the defaults for that modality. You may change the default stim modality for COMBO treatments to any of the stim modalities available with COMBO. You may also set a new default treatment time, if desired.

To save new default settings, after setting up the treatment, press and hold the START key for two seconds. At the end of two seconds, you will hear a beep indicating the treatment parameters have been saved. If you changed any parameters for the stim modalities during this treatment setup, those parameters will also be saved as the new default settings for that modality. Any ultrasound parameters that are saved will apply only to combo treatments—separate ultrasound treatments may have separate default settings.

2. Press **STOP** if it is necessary to stop a treatment before time has expired.

When the treatment time has elapsed, the current to the patient stops and a tone sounds notifying you of the treatment end. Treatments in progress may be stopped at any time using one of the following methods.

STOP: Press this key to stop all treatments at all channels.

REMOTE STOP: During “unattended therapy,” a patient stop button is provided to allow the patient to stop treatment. The remote cord should be plugged into the machine prior to starting the treatment. When the remote stop button is pressed, all output from the device is stopped, time is set to zero, and a tone sounds briefly.

STOP ONE TREATMENT ONLY: If you have more than one treatment in progress, you can stop one treatment by either of the following methods. First, press the channel toggle key to select the channel to be stopped (that channel’s light is green when selected).

FUNCTION-STOP. Press and hold the FUNCTION key and press STOP.

REDUCE THE TREATMENT TIME TO ZERO. Press the Time down arrow until the Time display reaches zero. The device beeps when the time reaches zero.

The output for the channel(s) selected is stopped (during a combo treatment this includes both stim and sound channels), and the device then displays the parameters for the next treatment that remains in progress (if any).

NOTE: Pausing a Combo Treatment

In Combo mode, if a treatment is paused by any means (either by pressing the PAUSE key or as a result of a soundhead that has become too hot), the ultrasound output is stopped and the treatment timer is paused. However, the stim current continues to be delivered. Therefore, the pause condition should be corrected as quickly as possible and the treatment resumed, or the treatment should be stopped completely by pressing the STOP button.

If the button on the **REMOTE STOP** cable is pressed during a Combo treatment, both the sound and the stim portions of the treatment are stopped at once.

Modify Treatment

- Modifications to a treatment in progress may be made to both modalities used. See the instructions earlier in this manual for specific modification instructions for each modality.

Keep in mind that since the stim and the ultrasound modalities share the Time and Power-Intensity displays, you will need to select the desired output channel with the channel toggle key before making changes to the ultrasound or the stim portion of the treatment.

- Treatment time for both treatments is simultaneous. Changing the treatment time affects both therapies.

Combination Default Settings

The factory default for a combination treatment is an ultrasound treatment with a premodulated treatment and the respective default settings for those two modalities. If you save defaults during a Combo treatment the following settings are saved:

- The stim modality that is selected for the current combo treatment is saved as the default stim treatment for combo.
- Stim parameters for this setup are saved, and become the default settings for that stim modality both during combo and during separate treatments.
- Ultrasound parameters for this setup are saved, and become the default ultrasound settings for combination treatments only (non-combination ultrasound treatments may have different default settings).
- The treatment time is saved as the default treatment time for combination treatments.

Simultaneous Treatments

The Dynatron 950plus and 650plus allow many combinations of simultaneous treatments to be delivered at once using available channels. Simultaneous treatments are not the same as combo treatments. A combo treatment combines ultrasound with a stim therapy into a single treatment. A combo treatment is always delivered to one patient. Simultaneous treatments are independent treatments that are set up separately, that have separate treatment timers, and which may be delivered to one or more patients at the same time.

There are very few limitations to the simultaneous treatments that may be set up with the Dynatron 950plus and 650plus. You can set up any number of separate treatments as described below with the exceptions noted:

- **Channels 1 through 4** may be used for any number of interferential, premodulated, Russian or biphasic treatments. For treatments using one channel, the device will select the next available channel. For treatments using two channels, the device will select a channel pair (1-2 or 3-4).
- **Russian or biphasic parameters** selected will apply to both channels in a channel pair (1-2, or 3-4), and you cannot have both a Russian and a biphasic treatment on the same channel pair. Therefore, if Channel 1 is set up with a Normal mode Russian treatment, Channel 2 may then be set up with a Normal mode Russian treatment (or a premodulated treatment), but not with a Biphasic treatment. The same is true of channel pair 3-4.
- Two separate **High Volt** treatments may be set up.
- A separate **Ultrasound** treatment may be set up, or a combination treatment using ultrasound and a single-channel modality.
- **The device allows only ONE attended therapy to be delivered at one time.** Attended therapies include ultrasound, microcurrent probe, and high volt probe treatments. While the attended therapy is in progress, other available channels may be used for unattended treatments (subject to availability of the channel needed).
- **Microcurrent therapy is delivered only through Channel 1 and through the Microcurrent Probes output jack at the same time.** Whenever any microcurrent treatment is in progress (probes or electrodes), Channel 1 is unavailable for any other use. However, Channels 2, 3, and 4 may be used for other stim treatments.

Set Up A Second Treatment

To set up the second (or third) treatment, after you have set up and started the first modality, press the modality key for the second treatment to be set up. The device automatically selects the treatment channel(s) to be used. The green channel light shows you the channel(s) selected for this treatment. Plug the lead or cable into the corresponding output jack(s) before you proceed with setting up the treatment.

Select the treatment parameters for the second treatment following the setup instructions for that modality provided in this manual. When parameters have been entered, press START.

Modify Simultaneous Treatments

You may VIEW and MODIFY parameters for the channel with the GREEN light.

While two or more treatments may be in progress at once, the “Time” display and the “Power-Intensity” displays can show the settings for only one channel at a time. The settings displayed are for the channel with the GREEN light only. Any other channel in use at that time will have a YELLOW light to show it is active (delivering current) but its parameters are not currently displayed.

To change the settings for a channel or output that has a YELLOW light, press the channel toggle key one or more times until the light for the desired channel becomes **GREEN**. You hear a beep each time you press the channel toggle key. The Time and Power-Intensity displays also change to show the parameters currently in effect for the channel indicated by the green light.

CHANNEL / OUTPUT INDICATOR LIGHTS	
GREEN Solid	<ul style="list-style-type: none"> You CAN see and modify this channel's parameters. The channel is delivering current.
GREEN Flashing	<ul style="list-style-type: none"> You CAN see and modify this channel's parameters. The channel is not delivering current while the light is flashing.
YELLOW Solid	<ul style="list-style-type: none"> You CANNOT see or modify this channel's parameters at this time. The channel is delivering current.
YELLOW Flashing	<ul style="list-style-type: none"> You CANNOT see or modify this channel's parameters at this time. The channel is not delivering current while the light is flashing.

Stop One Treatment

STOP ONE TREATMENT ONLY: If you have more than one treatment in progress, you can stop one treatment by either of the following methods. First, press the channel toggle key to select the channel to be stopped (that channel's light is green when selected).

FUNCTION-STOP. Press and hold the FUNCTION key and press STOP.

REDUCE THE TREATMENT TIME TO ZERO. Press the Time down arrow until the Time display reaches zero. The device beeps when the time reaches zero.

The output at the selected channel is stopped, and the device then displays the parameters for the next treatment that remains in progress (if any). Pressing the STOP key or the Patient Remote Stop button will stop all treatments at once.

REMOTE STOP: During “unattended therapy,” a patient stop button is provided to allow the patient to stop treatment. The remote cord should be plugged into the machine prior to starting the treatment. When the remote stop button is pressed, all output from the device is stopped, time is set to zero, and a tone sounds briefly.

Setting Defaults

Each of the modalities has default settings that are automatically selected when you press that modality key. The default setting feature allows you to set up a treatment with common treatment parameters in just seconds. For guidance in selecting the appropriate settings for each modality, consult published medical literature.

Save New Defaults

If your most common treatment settings are different than the ones already set for this device, you can change the defaults to suit your own preferences. Setting new defaults is simple. And defaults may be changed again and again whenever needed.

1. Press the modality key desired (IFC, Premod, Russian, Biphasic, High Volt, Micro, or Sound).
2. Set up a treatment using your preferred settings.
3. If this is an actual treatment you may increase the intensity now (intensity is not saved with the default settings). This step is optional.
4. **PRESS and HOLD the START** key for two full seconds to **SAVE** the new settings. You will hear a beep to signal that the new settings have been saved.

If the intensity was set before you pressed the **START** key, the treatment will begin upon pressing **START**. You may proceed with delivering the treatment now, or you may stop the treatment.

Example:

If, for example, your most common premodulated treatment uses the alternating High/Low frequency setting and you prefer to treat for 15 minutes. Set the new defaults as follows:

1. Press **PREMOD**.
2. Press the **HIGH/LOW** toggle key one or more times until both the High and the Low indicator lights are on.
3. Use the **TIME** arrow keys to change the time to 15 minutes.
4. **PRESS and HOLD the START** key for two full seconds.

<p>NOTE: You can save defaults at any time during treatment setup or while a treatment is in progress. Select the desired channel, then press and hold the START key for two seconds. A beep confirms that the new settings have been saved. Only defaults for the selected channel are saved.</p>
--

Restore Factory Defaults

If you have saved your own defaults, but would like to return ALL your default settings to those that were set at the factory, do the following:

1. Turn the machine off.
2. Press and hold the START key while turning the machine on. Continue holding the Start key down until you hear machine beep and you see the display message “RST FP” which indicates the parameters have been reset. You may now proceed with treatment setup.

Interferential Default Settings

- High
- Target
- The first available channel pair (1-2 or 3-4)
- Time: 10 minutes
- Frequency Ranges (for both Interferential and Premodulated)
 - Default High Range: 80-150 Hz
 - Default Low Range: 0-10 Hz
 - Available Range: 0-150 Hz

Premodulated Default Settings

- High
- The first available channel (1 through 4)
- Time: 10 minutes
- Frequency Ranges (for both Interferential and Premodulated)
 - Default High Range: 80-150 Hz
 - Default Low Range: 0-10 Hz
 - Available Range: 0-150 Hz

NOTE: The default frequency ranges and the High/Low option you set will be the default settings for both Interferential and Premodulated treatments. However, every treatment may be modified to have unique settings regardless of the defaults you set.

Russian / Biphasic Default Settings

- Normal mode
- 10/30 contraction/rest times
- Treatment time: 10 minutes
- Ramp up and down time: .5 sec.

Russian Stimulation:

	Default Setting	Valid Range
Pulse Rate	50 Pulses per second	1 to 500 (depends on Pulse Width)
Pulse Width	10 mSec	.4 to 50 mSec

Biphasic Stimulation:

	Default Setting	Valid Range
Pulse Rate	50 Pulses per second	1 to 500
Pulse Width	200 µSec	50 to 400 µSec

High Volt Default Settings

- Continuous on time
- Treatment time: 10 minutes
- Ramp up and down time: .5 sec.
- Polarity: Negative
- Pulse Rate
 - Default High Range: 80-120 Hz
 - Default Low Range: 1-10 Hz
 - Available Range: 1-200 Hz

Microcurrent Default Settings

The Microcurrent treatment setup with electrodes is the default, and the following defaults are selected:

- Bipolar wave
- .3 Hz frequency
- 50 μ A intensity
- Time: 20 minutes, counts down
- Audible Tone: Off

If Probe treatment is selected, the following defaults are automatically selected:

- Negative unipolar wave
- 4 Hz frequency
- 300 μ A intensity
- Time: zero, counts up
- Audible Tone: On

Available Ranges for both Electrodes and Probes:

- Frequency: Between .1 and 500 Hz
- Intensity: Between 10 and 990 microamps (in increments of 10 μ A).

NOTE: For Microcurrent treatments you may save separate default settings for a probe treatment and for a treatment with electrodes. You may also indicate the most preferred option (between probes and electrodes). The last default setting saved (probes or electrodes) becomes the primary default when Microcurrent is selected.

Ultrasound Default Settings

- 1 MHz for 2, 5, and 10cm² soundheads, and 2 MHz for the 1cm² soundhead
- Continuous
- Time: 5 minutes

Combination Default Settings

In Combo mode you can save new default treatment time and the preferred stim modality. The stim settings in a Combo treatment are determined by the defaults of that modality. Separate ultrasound default settings may be saved for the combo treatment which will not affect ultrasound-only treatments.

Battery Operation

Use ONLY a Dynatronics-Approved Battery

Contact Dynatronics or your Dynatronics dealer to purchase the optional battery or to obtain specifications for an acceptable battery that may be used.* Do not substitute another battery without first confirming with Dynatronics that the battery you are purchasing may be used with this device.

Only use a battery that CANNOT be recharged while it is in use. Disconnect the battery charger from the AC power source before using the battery to supply power to this device.

An optional battery is available for the Dynatron 950plus and 650plus, allowing you to deliver up to hours of battery-powered treatments wherever power may be unavailable or unreliable. To use the optional battery, do the following:

1. Before use, ensure the battery has been adequately charged. DISCONNECT the battery charging cable from the battery while it is in use for treatment.
2. Plug the battery adapter into the jack labeled BATT on the back of the Dynatron 950plus or the 650plus device. Turn the battery pack on.
3. Set up and deliver treatments as you normally do.
4. When available battery power is reduced to a certain level, the device will flash a message BATT LO to indicate low battery power. The treatment can continue but you will probably be unable to set up and deliver another treatment when the current treatment has ended.
5. When the available battery power becomes too low to continue operating the device, the BATT LO message is again displayed, the treatment intensity is ramped down, and the machine is then shut off. Before you can continue with battery operation of the device, you must recharge the battery. If battery power is fully depleted, the message BATT BAD is displayed to indicate either a bad battery or to indicate the battery must be recharged. Any treatments that were running at that time will stop.

NOTE: Use the ON/OFF switch on the battery pack to control power to the device during battery operation. While the battery is attached to the Dynatron 950plus or 650plus devices, the battery's ON/OFF switch controls power to the device, overriding the device's own ON/OFF switch.

Battery Requirements

- 12 volt and at least 5 amps peak current (1.5 ampere hours minimum).
- Battery adapter cord
 - Cigarette lighter plug on one end (to attach to the battery pack) and a barrel plug on the other end (to fit a .325 barrel jack).
 - The cord needs to be a high quality gauge wire. Radio Shack carries a high quality cord that is recommended. Cat. No. 270-1534D. This cord comes with a 2 amp fuse. This needs to be replaced with a 5 amp fast blow fuse.

Note: If a low-quality gauge cord is used, you can get the BATT LO error when the battery is not low.

Battery Life

The length of time that a unit can be used with a battery pack is dependent on several factors:

- The amperage of the battery pack. A larger amperage will provide longer use.
- The modality used. Ultrasound requires more power than stim modalities.
- The intensity of the treatments. The higher the intensity, the higher the consumption of power.
- The use of multiple treatments. The more channels used, the more power is consumed.
- The amount of charge remaining on the battery.

As a general rule, the unit may be run continuously for 30 minutes to several hours depending on these factors.

Section III

General Modality Information

Interferential and Premodulated Therapy

Interferential (Quadpolar) Therapy

Interferential therapy uses four electrodes to deliver two currents, one current with a constant frequency of 4000 Hz and the other current with a variable frequency of 4,001 to 4150 Hz. The paths of these two currents cross resulting in a “beat” that produces the therapeutic frequency at the treatment site. The resulting frequency is between 1 and 150 Hz. An example of wave forms representing these currents is illustrated here.

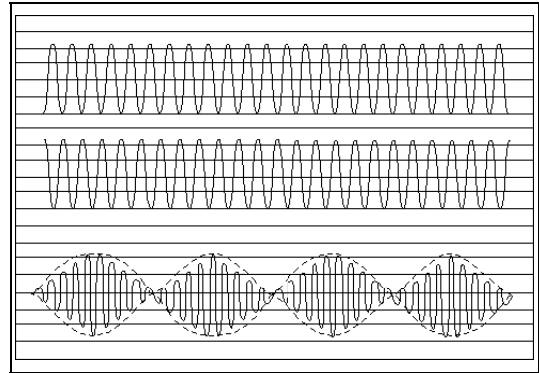

The “beat” phenomenon. Two waves of different frequencies over 4000 Hz, combine to produce a beat which is between 1 and 150 Hz.

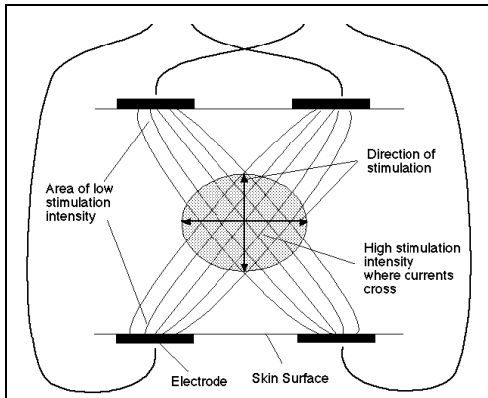

Stimulation produced by 4 electrodes.

In the interferential mode, two output jacks (Channels 1 and 2, or 3 and 4) are utilized with four electrodes placed in a crisscross fashion, “bracketing” the treatment site as shown in the illustration to the left. The output from Channel 1 (or Channel 3) is the constant 4000 Hz wave, while the output of Channel 2 (or Channel 4) is the variable 4000 to 4150 sine wave.

Premodulated (Bipolar) Therapy

Premodulated therapy utilizes one output jack and two electrodes. The current delivered is a composite wave form. In order to produce this composite current, two frequencies are “mixed” within the device prior to output. One frequency is 4000 Hz while the second frequency covers a range between 4000 to 4150 Hz.

With the Dynatron 950plus and 650plus, any of the four channels may be used simultaneously to deliver up to four separate, independent premodulated treatments. A crisscross electrode setup pattern should not be used when setting up multiple premodulated treatments. Note that a premodulated treatment usually requires a lower intensity setting than an interferential treatment since current is dispersed to only two electrodes rather than four (a smaller total dispersment area means greater current density at the treatment site).

Target

The Dynatron 950plus and 650plus feature Dynatronics' patented TARGET feature (available for interferential treatments only) simplifies electrode placement for an interferential treatment. Interferential treatment is performed using four electrodes with two channels. The channels produce two currents which intersect producing the interferential "beat." Without Target, it is often difficult to place the electrodes in the right position to produce the beat at the desired treatment area. This is because different types of human tissue (skin, muscle, bone, etc.) conduct current differently, making it impossible to guess the course of the two currents. Target helps eliminate the need to move the electrodes to get the desired result.

With Dynatronics' patented Target feature, you can move the center of interference (where the two currents cross) simply by moving your finger across the Target touch pad. Patient feedback will let you know when you have positioned the treatment at the desired spot.

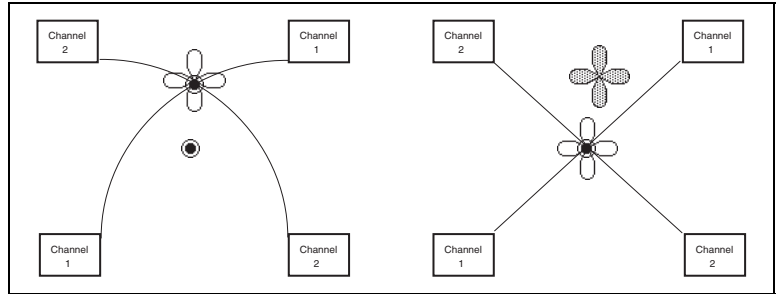

Normal Interferential currents cross at a point between electrodes. It is difficult to guess where they will cross as shown in the left diagram. With Target, you move the point of interference without moving electrodes (as shown in the diagram on the right)—just press the touch pad.

In the diagram here the electrodes are placed in a position to treat a point directly in the center of the electrodes. But the center of interference actually occurs at another point. (In these illustrations the point of interference is shown in a cloverleaf shape as interferential treatment affects a cloverleaf-shaped area.) Using the Target pad, the point of interference is easily moved to the desired treatment area.

Why Is Target Better?

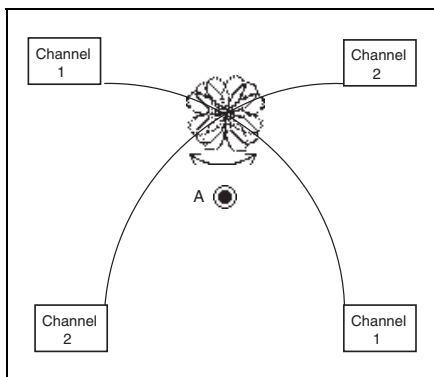

Other devices increase current at one channel while decreasing it at the other. This merely rotates the treatment. The center of interference does not move.

The Dynatron 950plus and 650plus employ a unique, patented method which actually moves the center of interference. With Target, the voltage output from both channels remains equal at all times; so wherever the treatment is applied, a full, deep interferential beat occurs. Other devices attempt to achieve this effect by increasing the current from one channel while decreasing the current from the other channel. This method only rotates the cloverleaf-shaped area, but the center of interference does not move. In addition, the depth of the beat is reduced.

Sweep

You can use the Sweep (Target Sweep) feature to bathe a wider area with the interferential current—up to 80 percent of the area within the electrodes may be covered. The Sweep feature utilizes the patented Target feature and moves the point of interference to cover a wider treatment area while still retaining the full interferential beat.

The Sweep option literally moves the point of interference inward and outward in a somewhat spiral pattern as shown in the illustration to the right, bathing about 80 percent of the area within the electrodes with the interferential current.

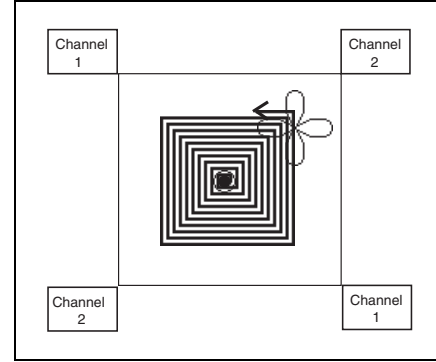

Sweep bathes a larger area with the interferential current.

Interferential Electrode Placement

When performing interferential therapy with a two-channel/four-electrode setup, it is important to arrange the electrodes in a crisscross manner so the current from one channel will intersect with the current from the second channel at the point where treatment is to be delivered.

Consult published literature for electrode placements for specific sites and conditions.

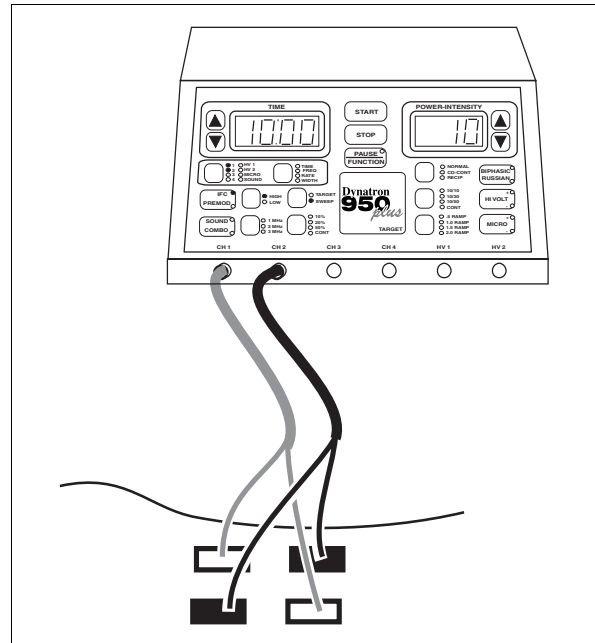

Interferential Electrode Placement

Russian / Biphasic Therapy

Russian Stimulation

With the Dynatron 950plus and 650plus' Russian stimulation mode, the output of the device is a 2500 Hz sinusoidal wave. Russian stimulation currents produce strong muscle contractions.

The Dynatron 950plus and 650plus allow you complete control over all the parameters of the Russian Stimulation treatment. Three treatment modes include Normal for firing one muscle, Reciprocal for firing two different muscles at different times, and Co-contraction for firing two different muscles simultaneously. The Dynatron 950plus and 650plus allow you to choose a muscle contraction/relaxation cycle from options of 10/10 (ten seconds on and ten seconds off), 10/30, 10/50, or continuous cycle. (The continuous duty cycle is not recommended for electrical muscle stimulation, but may be used for settings that are intended to effect other results than a muscle contraction.) In addition, you can modify the pulse rate, the pulse width, and the ramp time.

The Normal mode requires use of just one output jack (Channel 1, 2, 3, or 4). The Reciprocal and Co-Contraction modes utilize a channel pair (Channels 1-2 or 3-4).

Biphasic Stimulation

The biphasic stimulation feature is similar to Russian stimulation in the parameters that are selected and in the available options. It differs from Russian stimulation in the pulse width and rate ranges. Additionally, the biphasic pulse includes just one cycle (including one positive phase and one negative phase) per pulse.

Biphasic / Russian Parameters

The Dynatron 950plus and 650plus offer even greater control over the Russian and biphasic stimulation treatments through customization of the pulse rate and the pulse width. The default settings and the available ranges for each of these are as follows:

Biphasic Stimulation:

	Default Setting	Valid Range
Pulse Rate	50 Pulses per second	1 to 500
Pulse Width	200 µSec	50 to 400 µSec

Russian Stimulation:

	Default Setting	Valid Range
Pulse Rate	50 Pulses per second	1 to 500
Pulse Width	10 mSec	.4 to 50 mSec (depends on Pulse Rate)

The pulse rate and width should not be confused with the contraction/rest times in the treatment as these are different parameters; the pulse occurs only during the contraction time. The diagrams below illustrate the relationship of each of these parameters.

The **pulse width** indicates the duration (in milliseconds or microseconds) of the output cycle of the pulse, and the **pulse rate** is measured in number of pulse occurrences per second. Between pulses, current is at zero.

A 50 percent duty cycle or less is the usual duty cycle for Russian stimulation (the duty cycle includes one output cycle period and one zero-current period). A 50 percent duty cycle means that the length of the pulse width must be equal to or less than the zero-current period. The number of pulses per second affects the allowable range of pulse widths. A greater number of pulses per second means a shorter pulse width is allowed. The Dynatron 950plus and 650plus will not allow you to circumvent this rule.

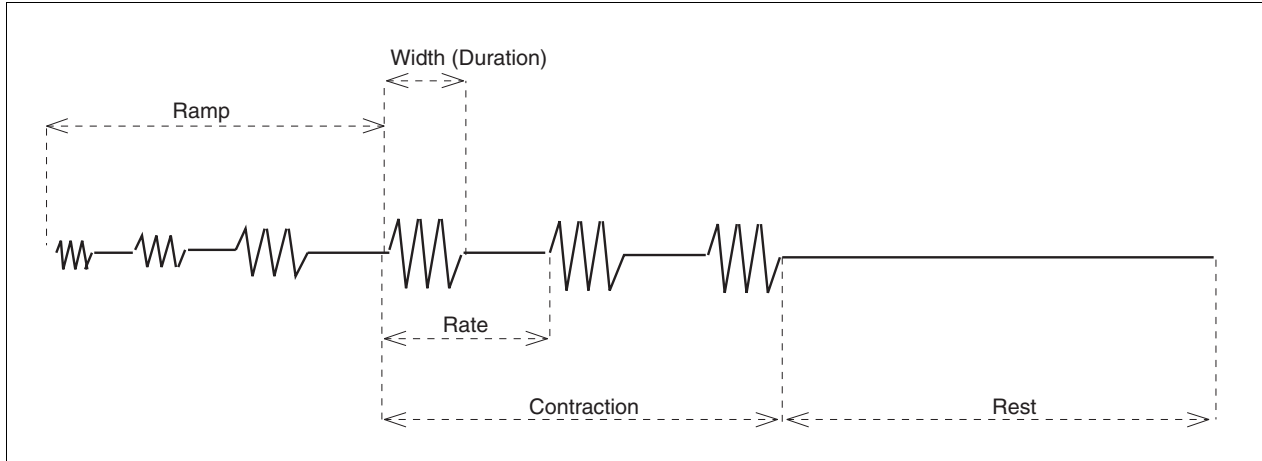

Russian Stimulation.

If a given Russian stimulation treatment has a 50 percent duty cycle, this means the output cycle is continuously repeating for half of the pulse duration (see “Rate” in the diagram above) followed by a zero-current period for the other half of the pulse duration.

Biphasic stimulation differs from Russian stimulation in the pulse width and rate ranges, as explained above. In addition, the biphasic pulse includes just ONE output cycle per pulse. As shown in the diagram below, one pulse cycle (including one positive phase and one negative phase) occurs, followed by a zero-current period.

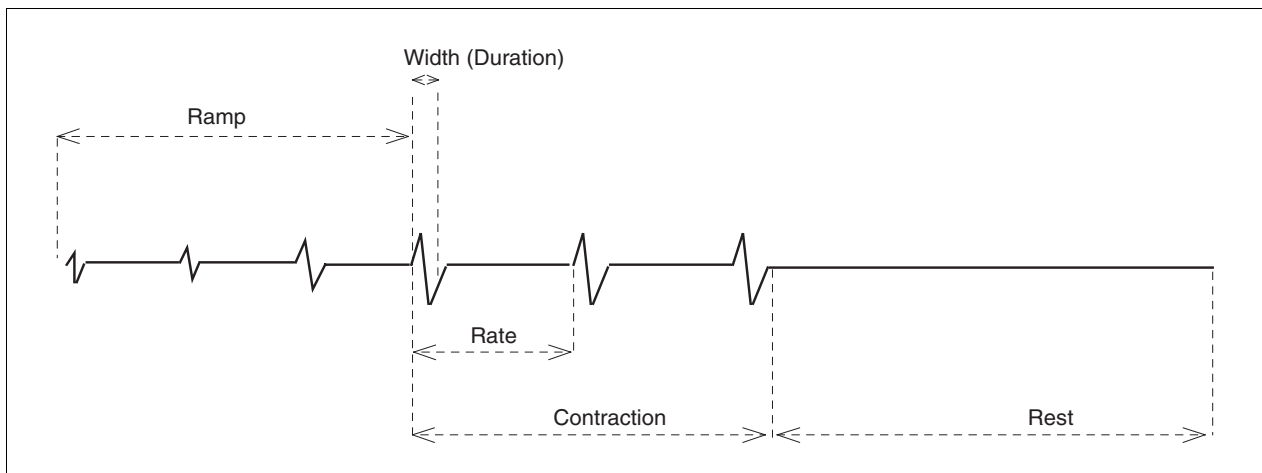

Biphasic Stimulation.

The pulse rate and width may be modified during setup of a Russian or Biphasic Stimulation treatment or may be modified while a treatment is in progress.

Since a channel pair shares pulse parameters during a Russian or biphasic treatment, you cannot mix single-channel Russian and biphasic treatments on the same channel pair. For example, with a Normal Russian in progress on Channel 1, if you attempt to set up a Normal biphasic treatment, the device will select Channel 3 or 4, but not Channel 2.

NOTE: If two biphasic or Russian stimulation treatments are in progress on one channel pair, you may not customize the pulse rate and width for that channel pair.

When you customize the pulse rate and width, it affects all simultaneous biphasic or Russian stimulation treatments on the channel pair (1-2 or 3-4). With reciprocal treatments, modification must be made during setup of the first channel.

If you are modifying the pulse rate and width for a treatment in progress, you should also modify the intensity, as all three of these parameters will affect delivered energy and patient comfort.

High Volt Therapy

High voltage pulsed stimulation is a pulsed DC current with pulse widths in the microsecond range and pulse rates ranging from 1 to 200 Hz, with a peak amplitude of up to 1.0 A utilizing a twin-peak monophasic waveform.

The Dynatron 950plus and Dynatron 650plus provide the option of one or two simultaneous high volt treatment setups using the dedicated channels labeled HV1 and HV2. Each treatment utilizes one channel with one or more active electrodes and a large dispersive electrode. Electrodes are placed on opposite sides of the affected area so treatment is “through” the affected area. An optional probe is available to accommodate hands-on treatment delivery.

High Volt Therapy with Electrodes

High volt therapy may be delivered as an unattended treatment using electrodes. This treatment setup uses one channel with two or more electrodes for unattended treatment. One electrode acts as the dispersive electrode, and one electrode is the active electrode. The active electrode is placed over the treatment site. It is recommended that the dispersive electrode be at least double the size in area of the active electrode. The lead for the active electrode may be bifurcated allowing placement of two active electrodes. However, the area of the dispersive electrode is recommended to be at least double the combined total area of the active electrodes.

High Volt with Optional Probes

High volt therapy with probes accommodates hands-on treatment. This therapy utilizes a high volt probe and a dispersive electrode. The high volt probe is an optional accessory and is not included in the standard accessory package for the Dynatron 950plus and 650plus.

High Volt Waveform

The high volt waveform is a twin-peak monophasic decaying waveform with either positive or negative polarity.

High Volt Settings

High and Low Sweep Pulse Rate. The user may select High (80-120 Hz) or Low (1-10 Hz) frequency ranges. During a treatment, the device scans through the range of frequencies selected. The settings for these pulse rate ranges may be modified and saved by the user. The available range is 1 to 200 Hz.

Single Pulse Rate. The pulse rate may be set to a single pulse rate instead of a range. The pulse rate is selected from a range of 1 to 200 Hz.

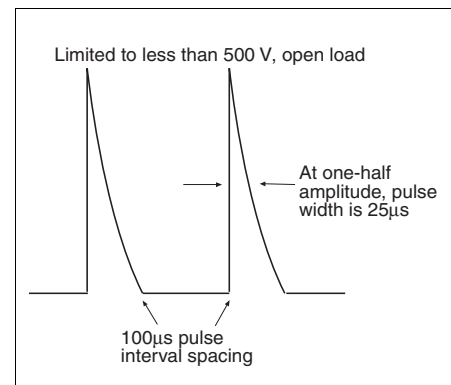

High Volt Waveform for positive polarity

Selectable Polarity. Positive or Negative monophasic current may be selected. You may also select both positive and negative and the current delivered alternates between the two polarities.

Selectable Duty Cycle. Continuous or on/off duty cycles may be selected. The Dynatron 950plus and 650plus allow you to choose a muscle contraction/relaxation cycle from options of 10/10 (ten seconds on and ten seconds off), 10/30, 10/50, or continuous cycle.

Selectable Ramp Speed. You can choose a ramp speed of 1/2 to 2-1/2 seconds in half-second increments. For patient comfort, the ramp occurs both before and after the “On” segment of the pulse.

Pulse Width. The pulse width is fixed at 25 μ s.

Pulse Pair Interval. The interval between the two pulses in the wave form is fixed at 100 μ s.

Intensity Display in Volts. The intensity display is shown in volts (peak voltage with no load) with a range of 1 to 500.

Microcurrent Therapy

Microcurrent is low-volt pulsed microamp stimulation which has been used for symptomatic relief of chronic intractable and post-surgical pain.

With the Dynatron 950plus or 650plus you can provide attended or unattended microcurrent therapy. Unattended therapy is delivered using electrodes. Attended therapy is delivered using an optional hand-held probe.

Microcurrent Therapy with Electrodes

Microcurrent treatment setup with electrodes is provided using Channel 1 and two electrodes. Electrodes are placed on opposite sides of the affected area so current is directed “through” the affected area.

Microcurrent Therapy with Probes

Microcurrent therapy with probes accommodates hands-on treatment for a variety of applications. With the Dynatron 950plus and 650plus, you can use the optional treatment probes to measure tissue conductance both before as well as during the treatment. The probes are used to treat very small areas, or to easily deliver treatment to a number of different areas in succession. This therapy utilizes the active probe and the ground probe. If desired, a dispersive electrode may be substituted for the ground probe. The active and ground probes are optional accessories for this device.

Microcurrent Waveforms

Three different output waveforms (polarity) may be selected with the Dynatron 950plus and 650plus: The first two are unipolar square waves having a monophasic pulse at a 50 percent duty cycle (equal on and off times). In the illustration above, the first

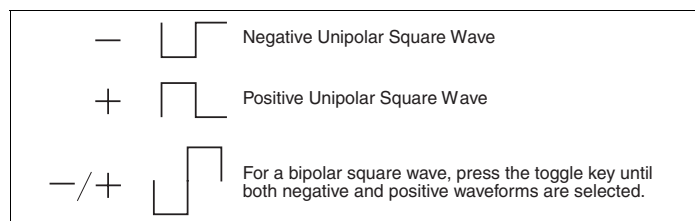

Microcurrent Waveform

unipolar waveform has negative polarity only, and the second has positive polarity only. The third waveform is a bipolar (negative and positive) square wave with a 50 percent duty cycle.

Microcurrent Settings

The Dynatron 950plus and 650plus offer the following ranges of microcurrent settings:

- Pulse Frequency Range: .1 to 500 Hz
- Microcurrent Pulse Output Current Range: 10 to 990 microamps

Ultrasound Therapy

(For Dynatron 950plus users only. The Dynatron 650plus does not offer the ultrasound feature.)

About Ultrasound

Ultrasound therapy channels sound waves through muscle, nerve, bone, and connective tissue to aid in reducing pain, muscle spasms, and joint contractures.

The physiological effect of ultrasound therapy depends upon the frequency of the ultrasound signal. The lower frequency (1 MHz) penetrates deeper than a higher frequency (such as 2 MHz or 3 MHz), thus the practitioner can decide which frequency to use according to the condition and depth to be treated.

A section in this manual entitled “Ultrasound Usage Cautions” provides some general guidelines for ultrasound treatment to help ensure you deliver safe and effective treatments to your patients. Further information about ultrasound application may be obtained from published medical literature.

With the Dynatron 950plus, four different soundhead sizes are available—1 cm², 2 cm², 5 cm², and 10 cm². And, you can **select three different frequencies without changing the soundhead**. The 2 cm², 5 cm², and 10 cm² soundheads each operate at 1, 2, and 3 MHz. The 1 cm² soundhead operates at 2 and 3 MHz. The desired frequency is easily selected both before and during treatment setup.

SmartHeads

The Dynatron 950plus includes Dynatronics’ new SmartHead™ ultrasound applicator. These soundheads have calibration numbers programmed into them allowing the soundheads to be freely exchanged with other Dynatron 950plus units or with the Dynatron 850plus, the Dynatron 150plus, and the Dynatron 125 models. There is no need to enter calibration numbers into the device when a new SmartHead soundhead is added.

Patient Coupling

Coupling (acoustic contact between the soundhead and the treatment site) may be provided either via a coupling agent (such as a gel or lotion) or in water (as with underwater treatments). Any material used as a coupling agent must be highly conductive of ultrasonic waves. Air is a very poor conductor of ultrasonic waves. Therefore, avoid allowing any air between the soundhead and the treatment area. During an ultrasound treatment the device measures coupling; a flashing TIME display indicates that coupling is poor and should be corrected. However, a treatment is not automatically paused due to poor coupling unless the soundhead temperature also becomes too high.

Soundhead Temperature

When coupling is poor, the temperature of the soundhead rises and the patient does not receive the full ultrasonic output. The Dynatron 950plus continuously measures the temperature of the soundhead to ensure both that the patient is receiving the optimal treatment and that the soundhead crystal is protected from overheating.

If the soundhead temperature approaches the maximum level, the POWER display will begin flashing. Treatment can continue beyond this warning level, but the user should ensure coupling is corrected. Under normal circumstances, improved coupling will reduce the soundhead temperature and allow the treatment to continue.

If the temperature reaches the maximum level, the treatment is automatically paused, the output power is stopped, a tone sounds and both the TIME and the POWER displays flash. The soundhead must then be cooled down before the treatment can resume.

The soundhead will cool slowly if placed in the soundhead holder or if held exposed to the air. Larger soundheads take longer to cool than smaller heads. To resume the treatment right away, you can place the soundhead in cool/room temperature water to cool the head more quickly.

NEVER USE ICE OR ICE PACKS TO COOL THE SOUNDHEADS as this is likely to cause thermal shock to the electronic components of the soundhead and may necessitate a costly repair. Heads damaged by thermal shock are not covered by the warranty.

When the temperature is again satisfactory, press the START key to resume the treatment; output power resumes, the displays return to constant, and the timer resumes. As long as the soundhead is too hot, the device will not allow you to resume the treatment.

To prevent soundhead overheating, check to be sure proper contact is being made throughout the treatment, or, when treating in water, make sure that the applicator head is completely under water. For direct coupling, you may need to apply more conductive gel or lotion during the treatment to achieve better coupling.

You can also reduce the power during the treatment if you are treating an area where it is difficult to obtain good coupling.

- **Do not drop the soundhead on hard surfaces, do not cool the soundhead with ice water or ice packs, do not allow the soundhead to reach maximum temperatures repeatedly, and do not hold the soundhead in the air while it is delivering ultrasonic waves. All of these conditions are likely to damage the soundhead crystal and/or cause stress to electronic parts. Damage resulting from these conditions is not covered under the warranty.**

Section IV

Contraindications, Warnings, and Precautions

Contraindications, Warnings, & Precautions for Interferential, Premodulated, Russian, Biphasic, and High Voltage Pulsed Stimulation

Contraindications

Thrombosis: It is possible that the current produces chemical changes in the blood leading to alterations in the clotting time. At present there is no hard evidence to support this. Nevertheless, treatment must not be given to any patient who is taking anticoagulants as it may render these ineffective. The effect of the current is on the platelets and would tend to spread any clot with perhaps fatal results in a patient with coronary thrombosis. If a patient has a history of deep vein thrombosis, even many years past, the treatment may increase rather than decrease swelling.

Pacemakers: Patients with pacemakers should avoid all high and medium frequency generators.

Cardiac Conditions: The electrodes should be placed to avoid the stellate ganglion and the heart itself. If there is a potential for heart problems, the clinician must exercise professional judgment and use adequate precautions. The clinician should not expose the patient to risk if possible heart problems are suspected.

Bacterial Infections: The effect on bacteria is uncertain, and it is advisable that bacterial infections should not be treated.

Malignancy: The use of Interferential, Premodulated, High Volt, Biphasic, or Russian Stim treatment is contraindicated in patients with clinically diagnosed cancer.

Additional warning from the Canadian Health and Welfare Department, Health Protection Branch: **WARNING: Thoracic applications are contraindicated.** Cardiac fibrillation may occur if output current is 50 mA RMS or greater for any output circuit.

Warnings

1. Adequate precautions should be taken in the case of persons with suspected or diagnosed epilepsy.
2. Severe spasm of the laryngeal and pharyngeal muscles may occur when the electrodes are positioned over the neck or mouth. The contractions may be strong enough to close the airway or cause difficulty in breathing.
3. Caution should be used in the transthoracic application of EMS devices in that the introduction of electrical current into the heart may cause arrhythmia.
4. This device should be kept out of the reach of children.
5. The Dynatron device should not be used in the following conditions:
 - Pregnancy
 - Acute and sub-acute thrombophlebitis
 - Potentially malignant lesions
 - Implants of any electrical nature
 - Do not use over a carotid sinus
 - Transcerebrally
 - Disturbances in cardiac rhythm

6. The long-term effects of chronic electrical stimulation are unknown.
7. This device should not be used to relieve pain syndromes until etiology has been established.

Precautions

1. Precautions should be observed following recent surgical procedures when muscle contractions may disrupt the healing process.
2. Some patients may experience skin irritation or hypersensitivity due to the electrical stimulation or electrical conductive medium. The irritation can usually be reduced by use of an alternate conductive medium or alternate electrode placement.
3. Interferential, premodulated, biphasic, Russian and high volt therapy must be used cautiously in the presence of any of the following conditions:
 - When there is a tendency to hemorrhage following acute trauma or fracture.
 - Over the menstruating uterus.
4. **Use extreme caution when administering a treatment where sensory nerve damage is present or in any case where there is a loss of normal skin sensation; this includes areas desensitized by medication.** When treating an area where there is loss of feeling, there is an increased danger of injuring the patient. Do not treat such areas unless you have sufficient training and experience in applying this therapy for such cases and you are confident you can deliver the treatment safely without injuring the patient.

When treating any conditions contributing to loss of sensation, or **any time the patient cannot feel the electrical stimulation**, do not exceed an intensity setting of 12-15 when using large electrodes (3-3/4" x 1-3/4") or an intensity setting of 8-10 when using small electrodes (1-3/4" x 1-3/4"), and select short treatment times (approximately 8 minutes). Be alert for any irregularities in the skin following the treatment.

Never use high volt therapy to treat an area where there is a loss of normal skin sensation.

5. Do not use in general area where high-powered, high-frequency transmitting surgical units are being operated. Short wave diathermy should not be turned on or used at the same time as this Dynatron device.
6. Do not use the same power outlet or line with a whirlpool and certain traction machines. In areas which are carpeted and static electricity is present, it may be necessary to use a conductive mat or anti-static carpet treatment to remove any static charge from the operator before touching the device.
7. To avoid causing possible interference with the operation of the Dynatron device, it should not be connected to anyone who is wearing or holding an RF transmission device (two-way radio, cell phone, beeper, etc.)

Treatment Setup Warnings

1. NEVER turn the power on or off while the unit is connected to the patient.
2. Always STOP a treatment before removing or attaching electrodes or leads to the patient. Leads and electrodes must only be applied to the patient before a treatment is started.
3. Never use worn or damaged leads or electrodes as these may result in injury to the patient. Check leads using the Lead Test function provided by this device.

Adverse Effects

Skin irritation and burns beneath the electrodes have been reported with the use of electrical muscle stimulators.

Use Only Dynatronics Accessories With This Device

The leads and electrodes provided by Dynatronics have been tested with Dynatronics devices and are appropriate for use with these devices. Dynatronics cannot guarantee the safety or performance of leads and electrodes purchased from other vendors.

Only use electrodes which are designed for use with this device. NEVER use monitoring electrodes such as ECG, EKG, or EMG. NEVER use electrodes specified only for TENS devices as those electrodes may not be adequate for use with the electrotherapies provided by this device.

Contact Dynatronics Customer Service if you have questions about appropriate electrodes for use with this device.

Caution

Any electrical stimulation has the potential to burn or irritate a patient's skin. The tendency towards burning is dependent upon several factors; the most important being patient susceptibility and current density. The practitioner has little control over patient susceptibility, other than to observe first time patients carefully. However, current density is totally controllable. It is important to note that the intensity displayed is not a measurement of the current delivered. For interferential, premodulated, and biphasic stim, this is a relative reading only. Current delivered at a given intensity setting is dependent upon the current setting, the size and type of electrodes used, and conductance.

Current density is the amount of current delivered, divided by the area through which the current is being delivered. Higher current density increases the tendency to burn or irritate. The current density can be reduced by decreasing the amount of current or increasing the area through which the current is being delivered. The area can be increased by using larger electrodes and/or making sure that the total area of the electrode is actually delivering current. Current density is also reduced when more electrodes are used (four instead of two).

Electrodes which are worn or have lost their adhesiveness, or carbon electrodes which are corroded and are not securely fastened, fail to deliver current evenly as required. These kinds of electrodes may have "hot spots" where higher than normal current density will be delivered. If the patient complains of "pin prick" sensations, the electrode may be delivering current through only a small portion of its area, and the electrode should be replaced.

Also see "Electrotherapy Usage Cautions" in this manual for further discussion regarding safe use of leads and electrodes.

Contraindications, Warnings, & Precautions for Microcurrent Treatment

Indications for Use

Microcurrent may be used to provide symptomatic relief of chronic intractable pain.

Contraindications

The following treatment conditions are specifically contraindicated for MICROCURRENT, and must be excluded:

1. Any electrode placement that applies current to the carotid sinus (neck) region.
2. Any use of TENS on patients who have a demand-type cardiac pacemaker.
3. Any electrode placement that causes current to flow transcerebrally (through the head).
4. The use of TENS whenever pain syndromes are undiagnosed, until etiology is established.

Warnings

1. The safety of TENS devices for use during pregnancy or delivery has not been established.
2. TENS is not effective for pain of central origin. (This includes headache.)
3. TENS devices should be used only under the continued supervision of a physician.
4. TENS devices have no curative value.
5. TENS is a symptomatic treatment and as such suppresses the sensation of pain which would otherwise serve as a protective mechanism.
6. Electronic monitoring equipment (such as ECG monitors and ECG alarms) may not operate properly when TENS stimulation is in use.
7. This device should be kept out of the reach of children.

Precautions

1. Isolated cases of skin irritation may occur at the site of electrode placement following long-term application.
2. Effectiveness is dependent upon patient selection.
3. Some patients may experience skin irritation or hypersensitivity due to the electrical stimulation or electrical conductive medium. The irritation can usually be reduced by use of an alternate conductive medium or alternate electrode placement.

This therapy must be used cautiously in the presence of any of the following conditions:

- When there is a tendency to hemorrhage following acute trauma or fracture.
- Over the menstruating uterus.
- Where sensory nerve damage is present or in any case where there is a loss of normal skin sensation; this includes areas desensitized by medication.
- Do not use in general area where high-powered, high-frequency transmitting surgical units are being operated. Short wave diathermy should not be turned on or used at the same time as this Dynatron device.
- Do not use the same power outlet or line with a whirlpool and certain traction machines. In areas which are carpeted and static electricity is present, it may be necessary to use a conductive mat to remove any static charge from the operator.

Adverse Reactions

Skin irritation and burns beneath the electrodes may occur with microcurrent treatment.

NOTE: When using microcurrent frequencies and intensities, it is extremely unlikely that a burn may occur. However, this possibility exists under certain circumstances; for example, if a high current setting is combined with poor electrode quality and/or high current density (small current delivery area). Monitor the patient's comfort throughout the treatment and change treatment settings if the patient finds the treatment intolerable.

Contraindications, Warnings, & Precautions for Ultrasound Treatment

Contraindications

The Dynatron 950plus ultrasound should not be applied in the following conditions:

- Pregnancy
- Acute and sub-acute thrombosis and thrombophlebitis
- Potentially malignant lesions, tumors malignant or benign
- Areas or lumps that may be suspected as cancerous or precancerous
- Third degree musculo-tendonous lesions
- Cardiac pacemaker
- Implants of any electrical nature
- Skin diseases
- Multiple sclerosis
- Osteomyelitis
- Disturbances in cardiac rhythm
- Tissue or bone with acute sepsis
- Arteriosclerosis or weakened blood vessels
- Hemophilia
- Where sensory nerve damage is present with a loss of normal skin sensation.

The Dynatron 950plus ultrasound should not be applied to the following areas:

- Transcerebrally
- To the eye
- To the ear
- Over a carotid sinus
- To the heart
- To major subcutaneous nerves and blood vessels
- To the spinal cord
- Around the bulbar area of the spinal cord
- To reproductive organs
- Over viscera (stomach, spleen, liver)
- Over epiphyseal areas of the bones in growing children
- Over stellate ganglion and subcutaneous major nerves
- To tissues previously treated by deep x-ray or other radiation
- Over the joint capsule in acute or sub-acute arthritic conditions
- Over ischemic tissue in patients with vascular disease
- Over a laminectomy site
- Over total joint replacements (the effect of ultrasound on the new plastics is unknown)

The Dynatron 950plus ultrasound should not be used over healing fractures.

<p>INTENSITY (POWER) SHOULD BE REDUCED IF PATIENT COMPLAINS OF PERIOSTEAL BONE PAIN (BONE ACHE)</p>
--

Precautions

The Dynatron 950plus must be used cautiously in the presence of any of the following conditions:

- When there is a tendency to hemorrhage following acute trauma or fracture.
- Acute bursitis. Do not use in continuous duty cycle mode.

Warnings

- Do not use in general area where high-powered, high-frequency transmitting surgical units are being operated. Short wave diathermy should not be turned on or used at the same time as this Dynatron device.
- Do not use the same power outlet or line with a whirlpool and certain traction machines.
- In areas which are carpeted and static electricity is present, it may be necessary to use a conductive mat to remove any static charge from the operator.
- Use a surge suppresser if power problems are encountered.
- Avoid unnecessary exposure to ultrasound (patient and therapist)

Electrotherapy Usage Cautions

The following are general cautions to be observed during interferential, premodulated, Russian, biphasic, and high voltage pulsed stimulation. For microcurrent electrotherapy, see separate "Microcurrent Usage Cautions" following this section.

Electrical stimulation, by its very nature, has the ability to irritate the patient's skin. Certain precautions should be observed to assure maximum safety and comfort for patients. A patient's tendency to have adverse reactions is dependent upon several factors. These factors are:

Current Density. This is the amount of current being delivered to the patient divided by the area through which the current is being delivered (the surface area of the electrodes being used).

Electrode Condition. Worn or dried out electrodes cause the current to concentrate in small areas of the electrode instead of going into the skin distributed evenly throughout the entire electrode surface. This has the effect of increasing the current density, since the current is being delivered through a smaller area.

Patient Susceptibility. Some patients' skin is more sensitive to electrotherapy currents. This can cause a reaction similar to a heat rash.

Electrotherapy treatment can result in a rash, burn, or blister. The tendency to do this is dependent upon the factors listed above and can be minimized by applying the following guidelines:

1. Use only moderate current. It is not always necessary to raise the treatment intensity to just short of the patient's pain threshold to achieve adequate results. Suggested maximum treatment levels for different electrode sizes are given below (for interferential or premodulated therapy). These values are not intended to be inflexible, but they should be a guideline. If your treatment goes beyond these intensities, you should examine the treatment to discover why such a high intensity setting is required.

Use as large an electrode as is practical for the application. Note that the current density in a 1.25" square electrode is over FOUR TIMES the current density in a 1.75" by 3.75" electrode for the same intensity setting. Using larger electrodes allows current to be delivered over a larger area of the body, keeping the current density to be as low as possible and minimizing the possibility for adverse reactions.

	<u>Electrode Size</u>	<u>Interferential / Premodulated Maximum Recommended Intensity</u>
Carbon Electrodes	3" round	25-30
	3" x 5"	30-40
Self-adhesive Electrodes	1.75" square	10-15
	1.75" x 3.75"	25-30
	1.25" round	10-12
	2" round	10-20
	3" round	25-30

NOTE: The above intensity settings should be considered maximum and not target intensities. These suggested settings apply to interferential and premodulated treatments. For high voltage pulsed stimulation the intensity is displayed in volts; therefore, these suggested settings do not apply. For biphasic or Russian stimulation treatments intended to effect a muscle contraction, it may sometimes be necessary to exceed these recommended limits to achieve the desired results. However, use caution when doing so to ensure that the patient can feel and can comfortably tolerate the electrical current. Also observe all other precautions in this section concerning leads and electrodes to ensure the higher intensity setting is not necessary as a result of defective accessories. **In any case, do not exceed patient tolerance in setting the intensity.** Consult published medical literature for more information about treatment protocols using each of these electrotherapy modalities.

2. Ensure that the area on the patient's skin where the electrode is to be placed is clean and free of all foreign matter. This includes powders, perfumes, and the like, as well as body oils or dirt and grime. Cleaning with an alcohol wipe should be adequate. Allow the alcohol to fully evaporate before applying the electrodes.

Iontophoresis occurs with all electronic therapies, and can drive any of the above-surface contaminants below the epidural layer, where an allergic reaction may occur.

3. Make sure the electrodes being used are in good condition. The polyadhesive electrodes should have good adhesion over the entire surface area of the electrode. The area where the leads attach to the electrode (either through a lead or a snap) should not be damaged such that the connection to the foil backing behind the adhesive is broken. Carbon electrodes should be deep black, and should be free of cracks in the electrode surface.

Any electrode which is suspect should be discarded—it's not worth the price of an electrode to risk harming a patient.

4. Some patients tend to be much more sensitive to electrotherapy treatments. On patients with this tendency, treat with reduced intensity and/or shorter treatment times, with possibly more frequent treatments, if required. Most reactions are localized and very short-lived, so limiting the exposure should minimize any potential for adverse reactions.

Carbon Electrodes

Carbon electrodes provide an economical means of delivering electrotherapy to patients (not for use with microcurrent). This type of electrode lasts a long time and can be used again and again. However, if they are not properly cared for, these electrodes can fail to deliver the desired treatment and can present the possibility for injury to a patient.

To ensure greatest safety and effectiveness with your treatments, follow these rules when using carbon electrodes.

1. **Carbon electrodes must be well-moistened** prior to treatment setup. Dry carbon electrodes are very poor conductors of current and should NEVER be used. They may be moistened with either water or an electrolyte spray. Water is adequate for short treatments, but will evaporate too quickly for longer treatments. If water is used for longer treatments, you may need to interrupt the treatment and remoisten the electrodes. A special sponge fabric available with some carbon electrodes may be moistened well and used as a conductive medium (do not use ordinary sponges for this purpose). Do not use ultrasound gel as a conductive agent with carbon electrodes.

If you use an electrolyte spray, this liquid may be diluted with equal amounts of distilled water, if desired. This reduces the amount of build-up on the electrodes yet usually provides adequate moistening of the electrodes.

NOTE: As you increase the intensity to higher levels during setup, if your patient feels a “biting” sensation or if the patient feels nothing, this indicates you are not getting adequate conductivity—the electrode may be too dry or is not moistened evenly across its entire surface. Stop the setup and correct the problem.

2. **Carbon electrodes must be free from any build-up.** If electrodes have a build-up from body oils or a moistening agent such as an electrolyte spray, conductivity is greatly impaired. If treatment is allowed to continue, intensity could be inhibited. When using carbon electrodes with any electrotherapy device, you must make sure conductivity is not impaired due to any type of build-up on the electrodes.
3. **Carbon electrodes eventually wear out.** Do not assume you can safely use carbon electrodes indefinitely. Over time these electrodes will wear; and when worn, the amount of current delivered through the electrode will decrease and will be inconsistent over the surface of the electrode. As a general rule, carbon electrodes that are used regularly should be replaced at least every six months.

**Do not take chances with patient safety!
Discard worn carbon electrodes!**

If you think your carbon electrodes are showing wear, you can send them to Dynatronics to be tested with an ohm meter. Good carbon electrodes should test at between 40 and 200 ohms. Unfortunately, practitioners frequently send us electrodes having resistance measuring in the thousands of ohms! Overused electrodes such as this present a potential hazard to the patient.

How to Clean Carbon Electrodes. Carbon electrodes from Dynatronics may be cleaned using a mild soap and a small brush (such as a nail brush). They may also be sterilized in an Autoclave. Daily cleaning is recommended.

Self-Adhesive Electrodes

Dynatronics’ “Polys” self-adhesive electrodes are intended for multiple usage when used appropriately. Improper use of the electrodes can decrease the life of the electrode and could even result in harm to your patient. The following instructions will help you achieve maximum usage from your electrodes while ensuring patient safety and comfort during treatment.

1. **Make sure the electrode is adhering and making contact with the skin across the entire surface of the electrode.** Electrodes will lose their adhesive quality when exposed to air, dust, dry skin, etc. To retain adhesiveness, electrodes should be stored in a tightly sealed pouch until used. The patient’s skin should be clean and free from oils or flakiness.

To Restore Adhesiveness:

- Before a Treatment: Before placing the electrode on patient, moisten the patient’s skin with a damp cloth using plain water, then apply the electrode to the skin.

- After a Treatment: Spray the adhesive side of the electrode with plain water, rub it lightly with fingertips, then reapply the electrode to its plastic backing and seal it tightly in its storage pouch. Do not use an electrolyte spray to remoisten self-adhesive electrodes as this substance can destroy the adhesive.

With this method of rehydration, after a couple of hours electrodes can regain up to 90 per cent of their original adhesive quality.

2. **NEVER use a self-adhesive electrode for more than 15 treatments (maximum).**
3. **NEVER use STRAPS, weights, or other devices to attach self-adhesive electrodes to the skin. If an electrode has lost its adhesive quality, you can use one of the methods given above to rehydrate the adhesive, or you should discard the electrode. Using straps and weights with self-adhesive electrodes could have an unpredictable effect on the electrodes and could cause injury.**

Combination Treatment Usage Cautions

When delivering combination ultrasound and stim treatments delivering stim current through the soundhead, the following are the recommended maximum stim intensities (refers to premodulated, biphasic or Russian stimulation only):

Head Size	Maximum Recommended Intensity for Electrotherapy
1cm ² head:	3-6
2cm ² head:	4-7
5cm ² head:	10-15
10cm ² head:	15-20

Lead Wires

Even with good care, lead wires will eventually develop breaks (open connections) simply from normal usage, and they must be replaced. **Lead wires have a limited lifetime and must be replaced about every six months.** Lead wires can be damaged due to jerking or pulling on the wires, excessive bending or tight wrapping of the wires, or running over the wire with a device cart. When setting up treatments, keep lead wires out of areas where a person could trip on them. When storing, lead wires should be loosely wrapped to prevent any kinking in the wire. Never use worn or damaged leads to treat a patient. Using faulty leads may result in injury to a patient.

Test Leads Daily. Lead wires should be tested regularly to ensure they are functioning properly and safely. A simple test performed with the Dynatron 950plus and 650plus makes daily lead testing convenient. Damaged or worn leads should be discarded and replaced. Under normal use, leads should be replaced about every 6 months. Instructions for testing are provided below.

Remove Corrosion From Lead Tips. Lead tips will build up corrosion through use. The lead tips must be cleaned and kept free of this corrosion in order to function correctly. To remove corrosion from lead tips, use steel wool to gently scrape off the corrosion. Take care not to scratch the metal plating of the tip during cleaning. If the tip's metal surface becomes pitted or uneven, the lead must be replaced.

Test Leads

To test leads, perform the following steps daily. Begin with the machine turned off.

1. Press and hold the TARGET/SWEEP toggle key while turning the device on. After initial power up, the **Lead Test** function is launched. If the device is already powered on, you can enter the Lead Test function by pressing and holding the FUNCTION key while pressing the TARGET/SWEEP toggle key. When the device is in the Lead Test mode, the Time display will read “LEAD.”
2. Plug a lead into Channel 1 (no other channel is used for the lead test). Remove snap adapters (if applicable) from the leads, and hold the tips (pins) together. **UNDER NO CIRCUMSTANCES SHOULD THE LEADS BE CONNECTED TO A PATIENT DURING THIS TEST!**
3. Press START. A tone will sound until good contact with lead pins is achieved.
4. Hold the pin ends of the lead together. The tone will sound when the connection is bad for any reason. **Hold the pins securely together, move the leads around, wiggle the cord, especially at the jack end of the cord.** If the tone sounds, even for a short time, check to be sure you are holding the pins together. If the tone continues to sound and you are certain the pins are touching, the leads are probably bad and should be replaced.
5. After the test, remove the lead from Channel 1. Plug in the next lead to be tested, and continue testing all leads in this way.
6. To exit the Lead Test function, press STOP. The device then shows the normal treatment displays, and you may proceed with treatment setup.

NOTE: The lead Test should be used for testing patient lead wires only. This is not an accurate means of testing carbon electrodes. Contact Dynatronics Customer Service to arrange for free testing of carbon electrodes or for instructions for testing these electrodes.

Current Limit

The Dynatron 950plus and 650plus continuously measure the actual current output during a treatment and limit the output current to the level indicated in “Technical Information” in this manual. As you increase the intensity of a treatment, you also increase current output. If you reach the maximum current limit, the device issues a warning (described below). This warning is to alert you to the fact that you may have set the treatment intensity too high and to prevent the possibility of patient discomfort caused by too high current output.

Current Limit Warning

When you reach the maximum output current limit, the device will:

- Immediately stop increasing the intensity and automatically reduce the intensity a few increments
- Beep several times
- Flash the intensity display

You should rarely, if ever, encounter the current limit warning during a patient treatment as reaching the current limit would often require an intensity setting that is uncomfortable and intolerable to most patients. For patient safety and comfort, you must address this warning before continuing with the treatment. Consider the following possible causes, for example:

- The patient is unable to adequately feel the current and is unable, therefore, to report discomfort at the high intensity level.
- When using four very large electrodes for a treatment, current is dispersed over a larger electrode surface area permitting a higher intensity setting without discomfort to the patient.

As you increase the intensity, ensure that the patient feels the current as expected. If the patient is unable to feel the current, you could unintentionally raise the current to a level much too high and risk causing unnecessary, possibly severe discomfort to the patient. Keep the intensity very low if the patient has little or no feeling in the treatment area (see “Contraindications, Warnings, and Precautions” in this manual).

Keep in mind, a wide range of factors can cause the patient to lack sufficient feeling in the treatment area, including, but not limited to, pain control drugs, use of ice packs, neurological damage, etc. Always consider these and other factors when delivering an electrotherapy treatment, and determine intensity settings based upon your medical expertise and judgment.

If you encounter the Current Limit warning, it could indicate that the patient cannot adequately feel the current. Ensure that the patient can feel the current. If you are treating an area that may be desensitized for any reason, reduce the intensity immediately. Read all the warnings regarding treatment of desensitized areas provided in this manual under “Contraindications, Warnings, and Precautions.”

Microcurrent Usage Cautions

Microcurrent uses only very low frequencies and the current generally is not felt by the patient. However, microcurrent at high intensity settings, especially when using probes, can sometimes be felt by the patient, and may even be uncomfortable for the patient. This is a result of current being concentrated at a very small area.

As with all forms of electrotherapy, current density is dependent upon the current setting, the intensity setting, the size and type of electrodes used, and conductance. Higher current density increases the possibility for patient discomfort. The current density can be reduced by decreasing the amount of current (intensity) or increasing the area through which the current is being delivered. The area can be increased by using larger electrodes and/or making sure that the total area of the electrode is actually delivering current.

Read more about current density in “Electrotherapy Usage Cautions” earlier in this section.

When delivering microcurrent therapy, observe the following guidelines:

1. Use only moderate current. Consult published literature for recommended settings for microcurrent treatment.
2. When using microcurrent probes, keep in mind that all of the current is delivered through the tip of the probe resulting in much higher current density than when using electrodes. Therefore, low to moderate intensity settings will be much more comfortable for the patient, especially when treating sensitive areas.
3. When using electrodes, ensure that the area on the patient’s skin where the electrode is to be placed is clean and free of all foreign matter. This includes powders, perfumes, and the like, as well as body oils or dirt and grime. Cleaning with an alcohol wipe should be adequate. Allow the alcohol to fully evaporate before applying the electrodes. Iontophoresis occurs with all electronic therapies, and can drive any above-surface contaminants below the epidural layer, where an allergic reaction may occur.
4. Make sure the electrodes being used are in good condition. The polyadhesive electrodes should have good adhesion over the entire surface area of the electrode. The area where the leads attach to the electrode (either the pin connector or a snap) should not be damaged such that the connection to the backing behind the adhesive is broken. Carbon electrodes should be deep black, and should be free of cracks in the electrode surface.
5. Some patients tend to be much more sensitive to microcurrent treatments. On patients with this tendency, treat with reduced intensity and/or shorter treatment times, with possibly more frequent treatments, if required.
6. If electrodes are placed on an uneven skin surface, such as over a raised mole, the electrode may not adhere evenly over its entire surface and current could be intensified at the raised area, causing discomfort to the patient.

Ultrasound Usage Cautions

(For Dynatron 950plus users only. The Dynatron 650plus does not offer the ultrasound feature.)

Ultrasound, by its very nature, has the ability to irritate the patient's skin. While the benefits of ultrasound far outweigh any disadvantages, certain precautions should be observed to assure maximum safety and comfort for your patients.

A patient's tendency to have adverse reactions to ultrasound is dependent upon several factors. Some of these factors are discussed below. In addition to cautions listed below, read the section in this manual entitled "Contraindications, Warnings, and Precautions."

Applicator Movement

The rate of speed at which the applicator moves across the skin is very important in determining how much ultrasonic energy is delivered to an area. If the rate is too slow, the patient may feel periosteal pain (bone ache/pain). If the rate is too fast, or if the applicator head becomes uncoupled with the skin, the amount of energy delivered is reduced and the soundhead can overheat.

Patient Susceptibility

Some patients' skin is more sensitive to ultrasound output. This can cause a reaction similar to a heat rash.

Potential for Burns

It is possible for a patient to suffer a burn from ultrasound therapy if the therapy is not administered properly. Burns can occur for the following reasons:

- Too high intensity (power)
- Too low a frequency
- Holding the soundhead in one place on the patient's skin
- Moving the soundhead too slowly
- Treating an area where sensory nerve damage is present with a loss of normal skin sensation

Bony prominences are especially susceptible, as they reflect sound waves and increase intensity to the periosteum.

Desensitized areas can be overheated or burned without the patient realizing it, so extreme care must be taken with these patients (e.g. patients having desensitized areas due to diabetes, neural damage, medication, use of ice packs, etc.)

Burns can be avoided as long as the treatment causes no pain, tingling, excess heat or aching (for patients with normal skin sensation). Use sufficient coupling agent and make sure there are no bubbles in the gel. When treating in water, clear the bubbles off the soundhead and off the patient's skin.

An uncalibrated or faulty ultrasound unit can cause shear waves and standing waves that can also cause burns.

Output Power

Higher output levels have a greater potential for patient discomfort. Output power may be reduced by simply choosing a lower watt setting. Output power is also effectively reduced by selecting a pulsed duty cycle.

Penetration of Ultrasound Waves

The correct frequency should be selected for the depth of penetration desired: 1 MHz provides deeper penetration, 2 MHz provides moderate penetration, and 3 MHz provides more shallow penetration. The amount of penetration needed is determined by the density of tissue and the depth of the site to be treated. Care should be taken to select a penetration level that does not cause periosteal (bone) pain.

Coupling

The term “coupling” refers to the ability to deliver ultrasonic waves from the soundhead to the skin surface with as little impedance or dissipation of power as possible. The best coupling is achieved when the ultrasound head has full, direct contact over the treatment site or when the treatment site and soundhead are separated only by a substance that provides excellent conductance.

For example, water is an excellent conductor of ultrasonic waves. Therefore, ultrasound treatment in water provides excellent coupling.

Air is a poor conductor of ultrasonic waves. If any part of the soundhead is exposed to air during the treatment, coupling is decreased. When treating a patient outside of water, the soundhead must maintain good contact with the patient skin at all times. In addition, a good conductive gel or lotion should be used to ensure the best possible coupling. Many such products are commercially available specifically for ultrasound therapy.

Since air is a poor conductor of ultrasound, it is not advisable to introduce air into the water during an ultrasound treatment. The air bubbles in a whirlpool, for example, can decrease the effective ultrasound therapy to the patient.

Section V

Ultrasound Technical Information

For the Dynatron 950*plus* Only

Ultrasound Regulation

The Dynatron 950plus complies with the following:

- FDA 21CFR 1050(c)(1)(i). The error in indication of the temporal-average ultrasonic power shall not exceed ± 20 percent for all emissions greater than 10 percent of the maximum emission.
- FDA 21CFR 1050(c)(1)(ii). The sum of the errors in the indications of temporal-maximum ultrasonic power and the ratio of the temporal-maximum effective intensity to the temporal-average effective intensity shall not exceed ± 20 percent for all emissions greater than 10 percent of the maximum emission.
- FDA 21CFR 1050.10(c)(2). The treatment timer must be accurate to within 0.5 minute of the preset duration of emission for settings less than 5 minutes, to within 10 percent of the preset duration of emission for settings of from 5 minutes to 10 minutes, and to within 1 minute of the preset duration of emission for settings greater than 10 minutes.

NOTE: The Dynatron 950plus is accurate to within $\pm 1\%$ of any treatment time.

Pursuant to FDA 21CFR 1050.10(f)(1), the uncertainties in magnitude, expressed in percentage error, of the ultrasonic frequency, effective radiating area, and the ratio of the temporal-maximum to temporal-average effective intensity, pulse duration, and pulse repetition rate for the Dynatron 950plus are as follows:

- (1) Ultrasonic frequency $\pm 15\%$
- (2) Effective Radiating Area..... $\pm 50\%$
- (3) Ratio of the temporal-maximum to temporal-average effective intensity $\pm 20\%$
- (4) Pulse duration..... $\pm 10\%$
- (5) Pulse repetition rate..... $\pm 10\%$

Beam Profile

(For Dynatron 950plus users only. The Dynatron 650plus does not offer ultrasound.) The following diagrams show the typical spatial distribution of the radiated field for each size of Dynatron 950plus sound head. This applies to the radiation emitted into the equivalent of an infinite medium of distilled, degassed water at 30° C and with line voltage variations in the range of ± 10 percent of the rated value.

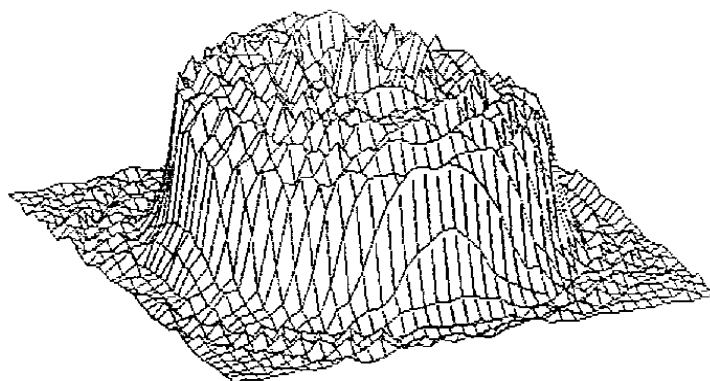

1 MHz

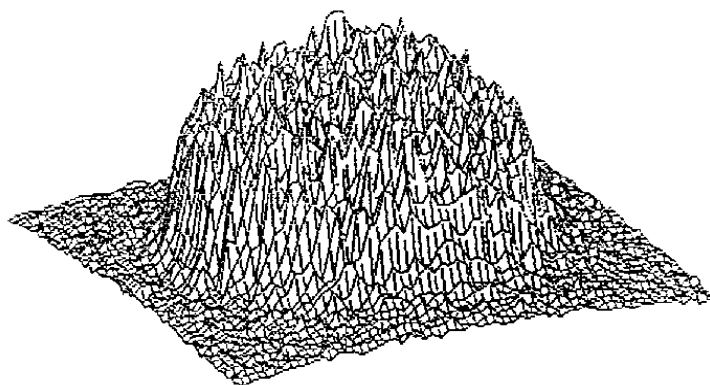

2 MHz

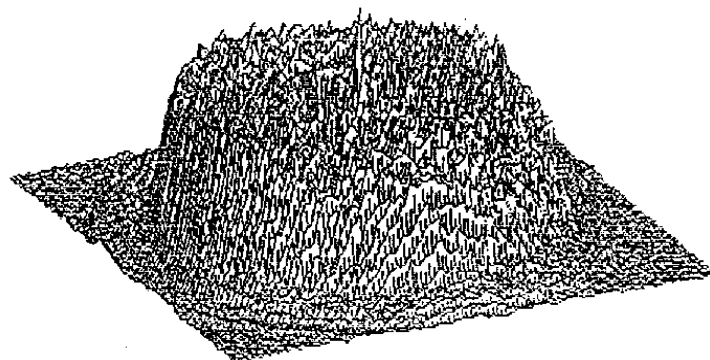

3 MHz

10 cm² Head. Near Field

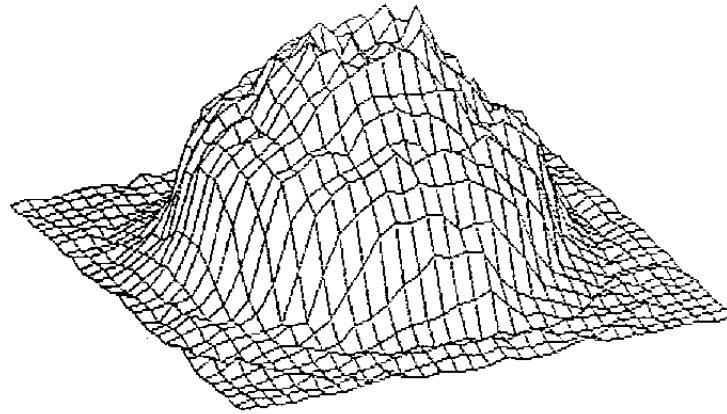

1 MHz

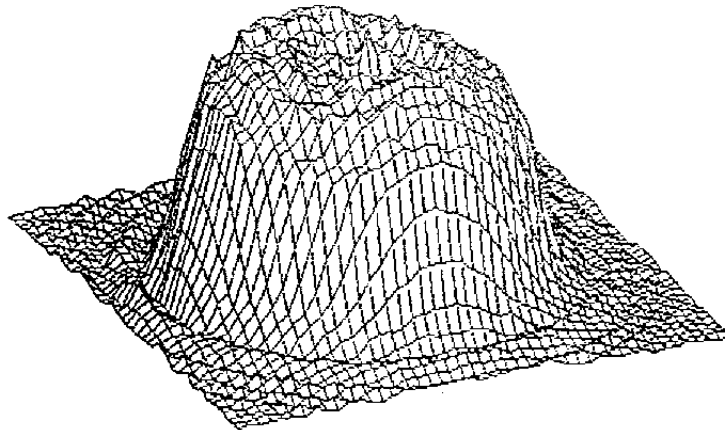

2 MHz

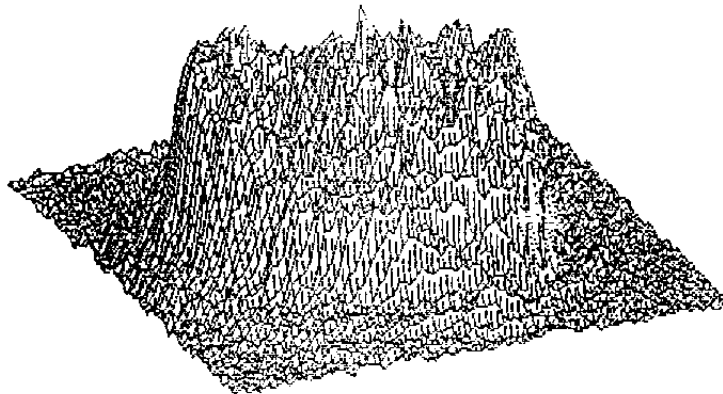

3 MHz

5 cm² Head. Near Field

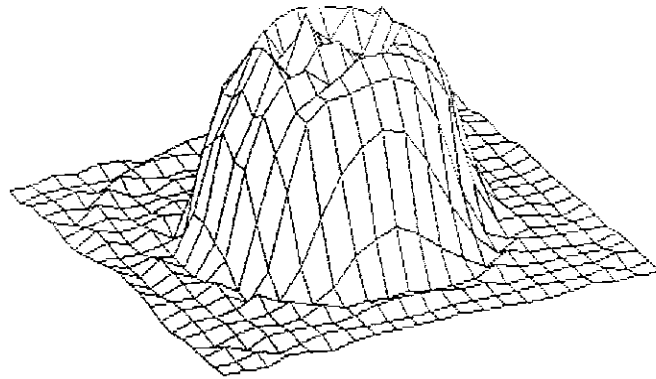

1 MHz

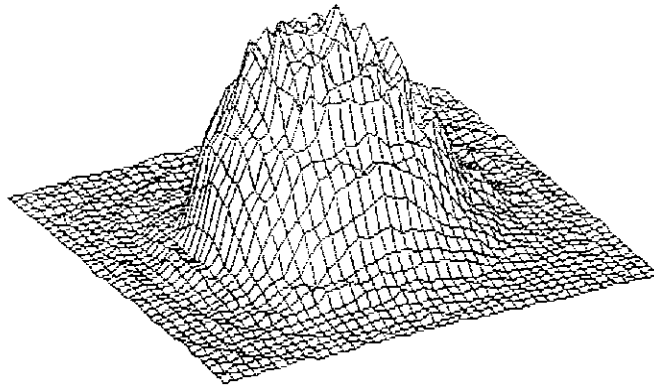

2 MHz

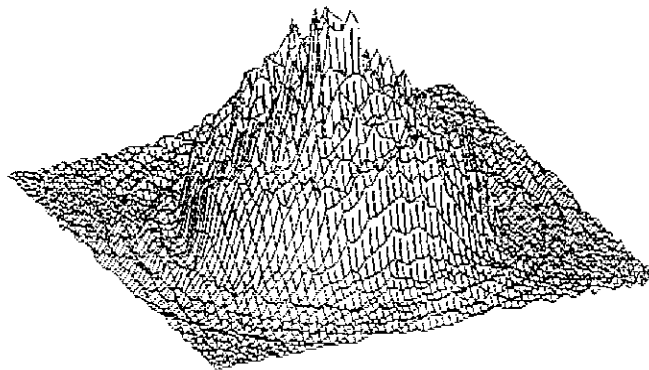

3 MHz

2 cm² Head. Near Field

Enter Soundhead Parameters

(For Dynatron 950plus users only)

New SmartHeads™

The Dynatron 950plus features Dynatronics' new SmartHead™ soundhead that has all calibration information self-contained. With the new SmartHead, it is not necessary to enter soundhead parameters as with earlier Dynatron devices. The new SmartHeads can be used with the Dynatron 125 or the 50 Series PLUS models. Do not use SmartHeads with former Dynatron devices including Dynatron 150, 850, 950, 800, or 300.

Using Older Model Soundheads With the 50 Series Plus

Soundheads that were designed for use with the Dynatron 50 Series products may be used with the Dynatron 950plus. However, these earlier models do not have the calibration information self-contained and it will be necessary for you to enter the unique parameters for that soundhead into the Dynatron 950plus before using the soundhead.

The following instructions are provided **only** in the event you need to enter soundhead parameters. Be sure to follow these steps carefully to ensure you have entered all parameters correctly. The procedure utilizes keys and displays on the key pad that are normally used for other purposes, but which have specialized applications in the Head Parameters Mode. If you have any questions about the following instructions, contact Dynatronics' Customer Service Department before proceeding.

NOTE: The following procedure IS NOT REQUIRED if you are using new SmartHeads™

1. **Head Calibration Printout.** Earlier soundhead models are shipped with a Head Calibration Printout sheet. The following is an example of this sheet. The sheet contains unique calibration numbers for a specific soundhead. The soundhead serial number appears on the sheet to assist you in matching the correct soundhead with the printed parameters.

HEAD CALIBRATION PRINTOUT			
HEAD SERIAL #: 105000 SIZE: 5 CM2			
	1 MHZ	2 MHZ	3 MHZ
FI:	1855	5605	3835
Z:	15	01	98
TEMP:	12	33	1

NOTE: THE ABOVE NUMBERS ARE PROVIDED FOR ILLUSTRATION ONLY AND SHOULD NOT BE ENTERED INTO YOUR DYNATRON DEVICE. USE ONLY THE ACTUAL NUMBERS PROVIDED WITH YOUR OWN SOUNDHEAD.

2. **Plug in Soundhead.** Turn the Dynatron 950plus off, then plug in the new soundhead.
3. **Enter Head Parameters Mode.** To enter the Head Parameters Mode, press and hold the **Duty Cycle toggle key** (10%, 20%, 50%, Cont key) while turning the machine ON. Continue holding down the Duty Cycle toggle key until the device finishes its startup sequence.

The unit senses and displays the head size in the Power-Intensity display. For example, if “5” is displayed, it means the device senses a 5 cm² head is plugged in.

4. **Enter 1 MHz Values.** You will begin by entering the 1 MHz values from the Head Calibration Printout. Make sure that the 1 MHz LED is lighted before entering these values.

Locate the 1 MHz column on the printout. You will enter the values shown for F1, Z, and TEMP. Enter those numbers as follows:

- a. Select CONT Duty Cycle: The CONT and 1 MHz LEDs are lighted. Enter the value for **F1 – 1 MHz** by pressing the time selection keys until the desired value is displayed in the Time display.

Use the Time Selection (up/down) keys to enter the desired number. The value you enter is displayed in the TIME display. Press and hold the up or down key to move more quickly to the desired number, or press and release the key to step up or down one digit at a time.

- b. Select 50% Duty Cycle: With the 50% LED lighted, enter the value for **Z – 1 MHz**.
- c. Select 20% Duty Cycle: With the 20% LED lighted, enter the value for **Temp – 1 MHz**.
- d. Select 10% Duty Cycle: With the 10% LED lighted, enter “0” (zero) as the value for **Coupling**. The coupling detection feature is not available with old-style soundheads.

5. **Enter 2 MHz Values.** Press the FREQ key to select 2 MHz. Make sure the 2 MHz LED is lighted. Locate the 2 MHz column on the printout, and enter those numbers as follows:

- a. Select CONT Duty Cycle: The CONT and 3 MHz LEDs are lighted. Enter the value for **F1 – 2 MHz** by pressing the time selection keys until the desired value is displayed in the Time display.
- b. Select 50% Duty Cycle: With the 50% LED lighted, enter the value for **Z – 2 MHz**.
- c. Select 20% Duty Cycle: With the 20% LED lighted, enter the value for **Temp – 2 MHz**.
- d. Select 10% Duty Cycle: With the 10% LED lighted, enter “0” (zero) as the value for **Coupling**. The coupling detection feature is not available with old-style soundheads.

6. **Enter 3 MHz Values.** Press the FREQ key to select 3 MHz. Make sure the 3 MHz LED is lighted. Locate the 3 MHz column on the printout, and enter those numbers as follows:
 - a. Select CONT Duty Cycle: The CONT and 3 MHz LEDs are lighted. Enter the value for **F1 – 3 MHz** by pressing the time selection keys until the desired value is displayed in the Time display.
 - b. Select 50% Duty Cycle: With the 50% LED lighted, enter the value for **Z – 3 MHz**.
 - c. Select 20% Duty Cycle: With the 20% LED lighted, enter the value for **Temp – 3 MHz**.
 - d. Select 10% Duty Cycle: With the 10% LED lighted, enter “0” (zero) as the value for **Coupling**. The coupling detection feature is not available with old-style soundheads.

7. **Store New Parameters.** After you have entered all parameters, press START to store them in the device’s memory. Then press STOP to exit this mode.

The above procedure must be performed for each separate soundhead for the device. Turn the device off before attaching the next soundhead, then turn the device on again with the soundhead firmly plugged in.

Calibration Procedure

New soundheads that accompany a new device are calibrated at the factory and do not require calibration before initial use. However, new soundheads purchased separately to add to an existing device may require re-calibration before use. Also, soundheads must be calibrated with the device every six months to a year to ensure proper operation. The calibration procedure is provided for use when recalibration is required. With the exception of calibration, all service on the Dynatron 950plus device should be performed by a Dynatronics service technician. If your Dynatron 950plus requires service, contact Dynatronics Customer Service at (800) 874-6251. **The calibration procedure MUST be performed by a qualified ultrasound technician using the proper equipment.** Calibration may be performed either by Dynatronics or by an ultrasound technician in your local area.

When to Calibrate: Dynatronics recommends that the Dynatron 950plus be calibrated at least annually to ensure the unit is working at its peak performance.

What to Calibrate: You must calibrate **all soundheads used with this device at 1, 2 and 3 MHz frequencies**, except the 1 cm² soundhead which is calibrated at 2 and 3 MHz only.

Equipment Required: You will require an **ultrasound power meter capable of accurately measuring outputs up to 3 MHz**. Check the manufacturer’s specifications to confirm your power meter meets this qualification. Ohmic Instrument UPM-DT1 or UPM-DT-10 are recommended for use (refer to the operation manual for these devices for instructions on their use).

Water Quality: Water used in the testing procedure must be **degassed water** with an oxygen content of four parts per million (4ppm) or less.

The following steps are provided to assist the technician with the calibration procedure. A calibration program is built into the software for the device. The procedure utilizes keys and displays on the key pad that are normally used for other purposes, but which have specialized applications in the Calibration Mode.

If you have any questions about the following instructions, contact Dynatronics' Customer Service Department before proceeding.

STEPS

1. Begin with the machine turned off. Plug the soundhead to be calibrated into the Dynatron 950plus ultrasound output jack and center the soundhead over the cone in the ultrasound power meter.
2. Enter the Dynatron 950plus' Calibration Mode by pressing and holding the **PAUSE** key while turning the machine on. The display windows first show the soundhead type that is plugged into the machine (see Soundhead Types Table below).

The soundhead type is displayed for about one second. Next, the display shows the stored frequency values for the soundhead that is being calibrated. The output power display is set to a value of zero. The LED for 1 MHz should be illuminated indicating the soundhead is now ready to be calibrated for this frequency. If it is not, press the toggle key to **select 1 MHz** now.

3. Press **STOP** and the **TIME UP ARROW** simultaneously to enter the Temperature Mode. The temperature of the soundhead is displayed in the Time display window. The soundhead must be at a temperature between 72 and 75 degrees. If the soundhead is not within this range, warm the water and/or the head before continuing. Press **STOP** to get out of the temperature mode. At this point there is zero output from the device. Zero the scale on your ultrasound power meter now. When the scale is at zero on your power meter, **press the START key** to begin.
4. Press the **UP/ DOWN arrow** keys located next to the Power display window on the Dynatron 950plus until the power meter shows the target value for the specific soundhead size (consult the table "Target Value - Power Meter" for target power meter readings).
5. When the watts reading on the meter is at target value for the soundhead and the reading is stable, press the **Duty Cycle toggle** key (this is the key that selects 10%, 20%, 50% or Continuous).

Soundhead Types Table

SmartHeads™:

Time Display = HS

Power Display:

2cm² = 2

5cm² = 5

10cm² = 10

Older Sound Heads:

Time Display only:

1cm² = H 1

2cm² = H 2

5cm² = H 5

10cm² = H10

Soundhead Types

6. The Dynatron 950plus performs the calculation internally for the “Z” (impedance value) and the coupling value. These values are automatically entered and stored in the Head Parameters for the device (this operation is automatic and invisible to the user). Record these values on the calibration sheet for future reference.

Target Value - Power Meter	
<u>Head Size</u>	<u>Power Meter Value</u>
1cm2	1 watt
2cm2	2 watts
5cm2	5 watts
10cm2	10 watts

Target value is 1.0 w/cm² for the soundhead size used.

7. Press the frequency toggle key to **select 2 MHz**. The 2 MHz LED will light indicating the soundhead is now ready to be calibrated at this frequency. Repeat steps 3 through 5 above.
8. Press the frequency toggle key to **select 3 MHz**. The 3 MHz LED will light indicating the soundhead is now ready to be calibrated at this frequency. Repeat steps 3 through 5 above.
9. If you wish to cancel the calibration procedure without storing any new calculations, press the **PAUSE** key.
10. This completes the calibration of one soundhead. For devices that use more than one soundhead, you must calibrate each of those soundheads individually.

To calibrate the next soundhead, turn the machine off, and repeat steps 1 through 10 above.

CAUTION: Avoid unnecessary ultrasound exposure.

Problem Solving

Soundhead Temperature Too Hot

If poor coupling occurs during a treatment, the temperature of the soundhead rises and the patient does not receive the full ultrasonic output. This device continuously measures the temperature of the soundhead to ensure both that the patient is receiving the optimal treatment and that the soundhead crystal is protected from overheating.

If the soundhead temperature approaches the maximum level, the POWER display will begin flashing.

For devices having software Rev. prior to 1.02:

If the temperature reaches the maximum level allowed, the treatment is automatically PAUSED, the output power is stopped, the treatment time stops counting down, both the Time and Power displays flash continuously. The soundhead must then be cooled down before the treatment can resume.

For devices having software greater than Rev. 1.01:

With software revisions greater than Rev. 1.01, the Time and Power displays do not flash, but the Time display shows the error message “HOT” (see Page 2 of this manual for instructions on determining the revision level of your device). When this condition occurs, the treatment timer is paused, output is stopped, and the soundhead must be cooled down before the treatment can resume. Once the soundhead is cooled, press Pause or Start to resume the treatment.

See "Ultrasound Instructions" in this manual for more information regarding warnings for a hot soundhead, and the new soundhead temperature graph (available for software revisions 1.02, 1.03, or later), as well as more complete information for cooling the soundhead before resuming treatment.

Cooling the Soundhead

The temperature alert not only ensures good coupling throughout the treatment, it helps avoid damage to the soundhead crystal. If the soundhead becomes too hot, it must be allowed to cool down before resuming the treatment. The head will cool slowly if allowed to sit at room temperature. To cool the soundhead quickly, you can place it in room temperature water. Sometimes just applying more conductive gel will adequately cool the head. Larger soundheads will take longer to cool down. **DO NOT USE ICE to cool the soundhead as this can cause thermal shock to the crystal and may necessitate a costly repair. Damage caused by thermal shock is not covered under the warranty.**

Whirlpool Treatments

If you are treating in a whirlpool, you may find the temperature reaches a high enough temperature to cause the display to flash (115°). This is a warning only to let you know you are approaching the temperature limit. You may, however, continue with the treatment at this level. If your whirlpool temperature is hot enough to cause the treatment to stop, you may need to adjust the temperature of the whirlpool.

Soundhead Temperature Too Cold

If the soundhead has been sitting in a very cold room or vehicle, it could be too cold to operate when you turn the device on. The keypad may not respond to key presses and you will be unable to use the device until the soundhead is sufficiently warmed. You must raise the temperature of the soundhead to about 60 degrees F. in order for the machine to recognize that the soundhead is present and to proceed with setting up a treatment. You can accomplish this with any of the following methods:

1. Press the flat face of the soundhead against the palm of your hand for 30 to 60 seconds to warm it slightly. This usually provides adequate warmth to the crystal to raise the temperature to the minimum acceptable level. Once the crystal reaches this level, you can proceed with treatment.
2. You can also place the soundhead in room temperature water to warm the crystal. However, **do not** place the soundhead in very hot water when the crystal is this cold as it could damage the crystal.

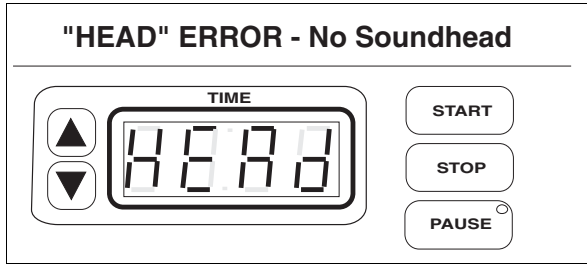

"HEAD" Error. This error message indicates the soundhead is not plugged in or for some reason is not being detected by the device.

No Soundhead

For devices having software greater than Rev. 1.01:

If the device cannot detect a soundhead during setup or delivery of an ultrasound treatment, the error message "HEAD" is displayed in the Time display. If this error occurs, check to be sure the soundhead is firmly plugged into its connector. If you are unable to clear the message by reconnecting the soundhead, contact Dynatronics' customer

service department at 1-800-874-6251 for assistance.

Other Error Messages in the Display

Certain conditions can cause an error in operation. When this occurs, the machine will not allow a treatment to be set up or delivered and will display an error message in the LED displays. An error message can consist of any combination of alpha-numeric characters which are not normally expected at any given point in treatment setup or delivery. Some errors are easily resolved by the following methods.

- Press STOP to stop the treatment (if any), and turn the machine off then on again.
- Check to be sure the soundhead has not become disconnected from the machine. The soundhead should be firmly plugged into its port. Only Dynatronics soundheads may be used with this device. If the soundhead has been dropped, it may be damaged. If the device operates normally with one soundhead, but not with another, the problem may be a damaged soundhead and you must contact Dynatronics Customer Service.
- Make sure the soundhead is not too hot. In this case the power LED display will flash. Any other display indicates a problem not related to a soundhead that is too hot. For hot soundheads, follow the instructions provided earlier in this section.
- Check to see if conditions may have caused extreme moisture condensation in the device. This could occur when the machine has become very cold then is brought indoors to a warm, humid environment. Condensation is a not a serious condition. Allow the machine to sit in a dry environment until the condensation dries. The machine will operate normally once the condensation is gone.

ERROR 13: The Error 13 message can occur if you plug in a soundhead while the device is on. If you get this error, make sure the soundhead is firmly plugged in, then turn the device off and on again. The message should be cleared.

If you have tried all of these suggestions, and the error is still displayed on the LEDs, the device may require service by the manufacturer. In this case, make a note of the error message and the sequence of events that cause the error, and contact Dynatronics Customer Service at 1-800-874-6251 for further assistance. **Do not send the device to Dynatronics without first contacting the Customer Service Department.**

Section VI

Technical Information

General Specifications

Other ranges, accuracy and precision values that are not provided here may be obtained from Dynatronics upon request.

Dynatron 950plus and 650plus Specifications

Power requirements: 100-240 V~, 50/60 Hz
Power consumption: 150 watts maximum
Fuse: 250 V, T1.6 AL slow blow
Dimensions: 9.5" W x 3.75" H x 10" D
Weight: 4.6 pounds

Stim Specifications

Interferential/Premodulated Therapy: 4000 Hz sine wave frequency modulated by a 4000 to 4150 Hz variable frequency sine wave of equal amplitude

Russian Stimulation: 2500 Hz sine wave amplitude modulated at 50 Hz

Biphasic Stimulation: 50 to 400 μ s pulse duration @ 1-200 Hz (50% levels, see diagram)

Power output: 0 to 100 milliamps into a 500 ohm load, each channel

NOTE: Devices for Canada and Japan have a 0 to **50** milliamps range. Devices with the 50 mA limit are available for any user specifying this limit.

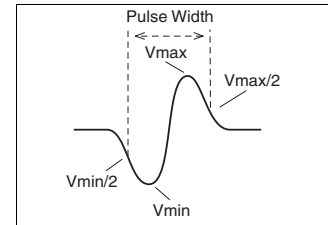

Biphasic Stimulation pulse width (duration).

Microcurrent Specifications

Output Waveform: Two different waveforms are provided: (1) a monophasic pulse (with equal on and off times), and (2) a biphasic wave (50% duty cycle). The polarity of each waveform is selectable by the user. With the biphasic waveform pulse, equal charge of both polarities is applied to the patient during each cycle of the treatment waveform.

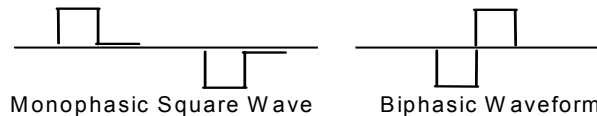

Pulse Frequency Range: .1 to 500 Hz

Maximum (open circuit) Voltage: 50V

Microcurrent Pulse Output Current Range: 10 to 990 microamps into 500 ohm load, constant current

High Volt Specifications

Waveform: Twin peak, monophasic

Pulse Width: 25 μ s

Pulse Rate Range: 1 to 200 Hz

Pulse Interval: 100 μ s

Maximum Power Output: Limited to less than 500 V, open load

Ultrasound Specifications (Dynatron 950plus only)

Ultrasound Power output:

1cm ² head:	2 MHz, 3 MHz	0-2 watts; 0-1.5 w/cm ² \pm 10%
2cm ² head:	1 MHz, 2 MHz, 3 MHz	0-4 watts; 0-2.0 w/cm ² \pm 10%
5cm ² head:	1 MHz, 2 MHz, 3 MHz	0-10 watts; 0-2.0 w/cm ² \pm 10%
10cm ² head:	1 MHz, 2 MHz	0-20 watts; 0-2.0 w/cm ² \pm 10%
10cm ² head:	3 MHz	0-10 watts; 0-1.0 w/cm ² \pm 10%

Environmental Conditions

Transport and Storage

This equipment is capable, while packed for transport or storage, of being exposed to environmental conditions not outside the following ranges:

- an ambient temperature range of -40°C to +70°C
- a relative humidity range of 10% to 100%, including condensation
- an atmospheric pressure range of 500 hPa to 1060 hPa

Operation

This equipment complies with requirements for operation in normal use under the least favorable combination of the following environment conditions:

- an ambient temperature range of +10°C to +40°C
- a relative humidity range of 30% to 75%, including condensation
- an atmospheric pressure range of 700 hPa to 1060 hPa

Safety Features of the Dynatron 950plus and 650plus

- Double redundancy protection on output amplifiers.
- Current sensing. If current reaches the current limit for the device, intensity is automatically reduced.
- All intensity levels are automatically set to zero at the end of treatment (ensures proper setting of intensity levels for the next patient).

- Internal surge protection protects against line noise, machine switching operation and any other type of interference that could cause patient discomfort.
- Soundhead temperature monitoring prevents the soundhead from becoming too hot, both to protect the soundhead crystal from damage and to ensure patient comfort.

Care and Cleaning Instructions

- Clean the outer surface of the Dynatron 950plus or 650plus with a slightly damp or lightly moistened cloth. Mild household cleaners work well. Do not spray the solution directly on the unit. First moisten the cloth and then wipe the unit off. Solvents, caustic solutions and harsh or abrasive cleaners must never be used.
- Avoid stretching cords to full length, bending cords sharply or wrapping cords tightly. Undue stress on cords can damage connections.
- Keep all food and soft drinks away from the machine and its accessories; spills can cause costly damage to the machine and repairs for this type of damage are not covered by the warranty.
- Do not drop the unit or the soundheads as severe damage will occur.
- Ultrasound heads should be cleaned with warm water. Always keep the head free from gel buildup.
- Do not use ice water for cooling soundheads. Do not allow soundheads to overheat repeatedly. This could result in thermal shock to the crystal. Damage of this type is not covered by the warranty.

Suggested Maintenance Schedule

SERVICE TO BE PERFORMED BY A TECHNICIAN:

Every 6 Months

- Test leads and carbon electrodes. Lead resistance should be less than 10% above the mean cable resistance. Greater values indicate strand breakage and lead should be replaced.

Annually

- Annual ultrasound calibration should be performed by a qualified technician.
- Check the output voltages and currents on all outputs.
- Inspect soundhead connectors on unit and on soundhead.
- Verify dac calibration and current limits.

MAINTENANCE PERFORMED BY USER:

1. Inspect accessories daily for wear and damage. Examine cables and connectors on the cables for any visible sign of wear or damage. Replace accessories as needed:
 - Replace lead wires and carbon electrodes at least every six months.
 - Replace self-adhesive electrodes after not more than 15 uses.

2. Examine ultrasound heads periodically for cracks which may allow ingress of conductive fluid.
3. If a machine or soundhead is dropped, or if it sustains damage due to lightning, severe power surge, submersion in water, or other incident that could cause damage to electronic components, the device must be examined by a Dynatronics technician before being returned to clinical use.
4. For older devices contact Dynatronics or your Dynatronics dealer for information and pricing for current upgrades to your device. Even if the machine is functioning properly, you can send it to Dynatronics for preventative maintenance service for a nominal charge; call for pricing.
5. Inspect device air vents periodically to ensure air flow is not blocked. An ordinary household vacuum hose may be used to clean dust from air vents externally.
6. Immediately report any device malfunction to Dynatronics Customer Service Department.

NOTE: BEFORE sending a device to Dynatronics for service, you must FIRST obtain a return authorization number. Call Dynatronics' Customer Service Department at 1-800-874-6251 and discuss any problems or required service to save time and ensure the machine is returned to you as quickly as possible.

Routine Ultrasound Calibration Inspections (Dynatron 950plus only)

Government agencies regulate the frequency at which ultrasound units must have their calibration checked. The device must still be examined at the periodic intervals specified by the governing agency for the country in which the device is used.

To have the inspection performed by Dynatronics contact Dynatronics' Customer Service Department. The device will need to be shipped to Dynatronics for the inspection. As an alternative, these periodic checks may be performed in your own locale by an independent contractor who is expert in checking the calibration of ultrasound equipment.

The calibration procedure MUST be performed by a qualified ultrasound technician using the proper equipment, and is recommended every 6 to 12 months.

Calibration instructions are included in this manual.

Software Updates

Software updates may possibly be made available by the manufacturer for this device in the future. A software update is installed in the Dynatron 950plus/ 650plus using a separate device known as a Dynatronics Download Box. Should updated software become available, the update may only be installed by Dynatronics or by a representative or technician under the supervision of Dynatronics.

CAUTION: Following software installation with the Dynatronics Download Box, factory default settings for the Dynatron 950plus/ 650plus must be restored before using the device. To restore factory defaults, begin with the Dynatron 950plus/ 650plus powered off. Then, press and hold the START key while turning power on to the device. Continue holding the Start key down until a beep is heard indicating the factory defaults have been restored. You may then reset customized default settings if desired. Complete instructions for using the Dynatronics Download Box for installing software accompany the Download Box.

NOTE: This software update information is provided for information only and is not intended to imply that software updates will, in fact, become available for this device.

Returning a Unit for Repair

Return Authorization

To send a unit to Dynatronics for repair, you **MUST** first receive authorization from Dynatronics. This authorization is represented by a Return Authorization (RA) number. An RA form is used internally at Dynatronics to help identify who is sending the unit in for repair and why. It shows customer complaint or problem information, and has the address where the unit should be shipped after repair. When a service call is received by Dynatronics, the following information must be supplied before an RA number can be issued:

1. User name and address
2. User phone number
3. Serial number of the unit
4. A description of the problem with the unit.

This information is important so we may identify the problem before the unit is shipped and ensure proper handling of the repair or disposition of the unit. The user or dealer name and address, and the serial number of the unit are required before Dynatronics will issue an RA number.

When the unit is received at Dynatronics, it is unpacked and inspected for shipping damage. An inventory of the parts that were sent with the unit is taken at that time and recorded on the RA sheet. Any observed damage is also noted on the sheet. The unit is then examined by a repair technician who evaluates the problems with the unit and writes observations on the RA form. The technician completes the repair, again writing the steps taken to repair the unit, listing the parts used, and recording the time taken in the repair. The technician dates and signs the form. The unit then receives a final quality assurance (QA) inspection by quality control staff member who signs the RA form indicating the QA is complete. One copy of the RA form is returned to the user with the unit to tell the dealer and the user what was done to the unit while it was in for repair.

Why the Information is Necessary





Dynatronics, is required by the FDA to keep records on all units sold consisting of 1) the date the unit was sold, 2) to whom it was sold, 3) any problems the customer has with that unit in the field, and 4) any information on repairs performed on the unit. The information collected also helps us improve the unit's performance. It helps us to identify trends and allows us to pinpoint a manufacturing or engineering change that will make the unit function more reliably.

Packaging and Shipping of Replacement Parts

All defective or broken parts should be shipped back to Dynatronics in the original shipping container. These containers are designed to withstand the punishment of shipping. If the original containers are not usable, find containers that are similar in protection so damage in shipping will be prevented. The person or company sending the unit to Dynatronics is responsible for any shipping damage resulting from a poorly packaged part or unit.

Definition of Symbols

Some or all of the following symbols are included in the labeling for this device. The meanings of the symbols are described here.

	Alternating Current
	Attention, consult accompanying documents
	Off (power: disconnection from the mains)
	On (power: connection to the mains)
	Type BF (patient-applied part)

Equipment Classification

This device is classified as follows:

- Protection against electric shock: Class I (protectively earthed enclosure)
- Protection against electric shock: Type BF (floating patient-applied part)
- Protection against harmful ingress of water: none
- Equipment not suitable for use in the presence of a flammable anesthetic mixture with air or with oxygen or nitrous oxide.
- Mode of operation: Continuous operation

Disposal of Equipment and Accessories

There is no risk posed in disposal of this equipment or its accessories. These items contain no hazardous materials.

Additional Technical Information Available (for Technicians Only)

Dynatronics will make available on request circuit block diagrams, component part lists, descriptions, calibration instructions or other information which will assist the user's appropriately qualified technical personnel to repair those parts of the equipment which are designated by Dynatronics as repairable and which will not violate protection of Dynatronics' proprietary information.

Dynatronics Electrodes and Lead Wires

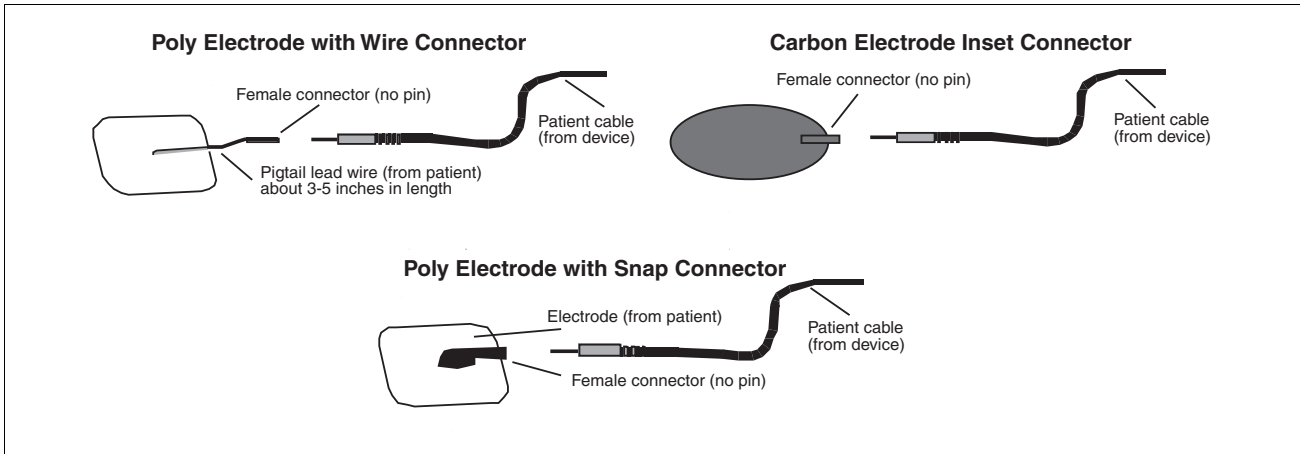

The FDA has issued a Public Health Advisory regarding “Unsafe Electrode Lead Wires and Patient Cables Used With Medical Devices.” This warning pertains specifically to lead wires with unprotected pins; that is, leads with one end connected to the patient and the other end having pins that can be inserted directly to a power source such as a wall AC outlet. The diagrams on this page illustrate the compliance of configurations using Dynatronics electrodes and lead wires.

Neither the Poly electrodes with snap adapters nor carbon electrodes have lead wires or pins that could allow direct connection to a power source. Polys electrodes with wire connector have a short pigtail (3 to 5 inches in length); the pigtails have female connectors. Since all Dynatronics electrodes have either no lead wire at all or very short pigtail lead wires, it is impossible to connect an electrode directly to an improper power source when the electrode alone is attached to the patient.

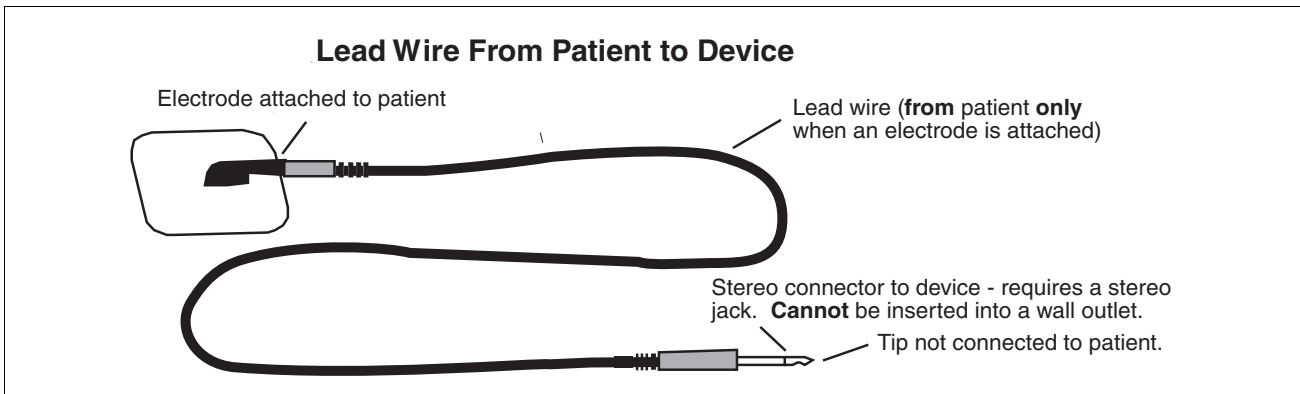

When the electrode is connected to a patient lead wire as shown in the diagram above, the stereo jack at the opposite end of the lead wire prevents connection of the cable to any power source other than a stereo jack as found on Dynatronics devices. The stereo connector is 1/4” in diameter and cannot be inserted directly into an AC power source. **NOTE: As of May 9, 2000 new FDA compliant lead wires are available from Dynatronics and are included with all new devices.**

Medical Device Reporting Requirements

Under the Safe Medical Devices Act (SMDA) of November 1990, the manufacturer and distributor are required to report specific incidents to the FDA. In the event of any applicable incident, you should report details of the incident to the Dynatronics Service Department at 1-800-874-6251. Reports should be submitted to the manufacturer immediately to allow the manufacturer to report to the FDA within 10 working days.

- If you receive information that reasonably suggests a probability that a device caused or contributed to a:
 - death
 - serious injury, or
 - serious illness
- If you receive information that reasonably suggests a device malfunction and a recurrence will probably cause:
 - death
 - serious injury, or
 - serious illness

Definition of serious injury:

A “serious injury” is an injury that (1) is life threatening, (2) results in permanent impairment of a body function or permanent damage to body structure, or (3) necessitates medical or surgical intervention by a health care professional to (i) preclude permanent impairment of a body function or permanent damage to body structure or (ii) relieve unanticipated temporary impairment of a body function or unanticipated temporary damage to a body structure.

Reference: Food and Drug Administration, HHS. 21 CFR Ch. 1 (4-1-90 Edition), 803.9 (h).

Reporting any Incident of Patient Discomfort

Dynatronics recommends that **if discomfort of any level is reported by the patient, the treatment be stopped immediately.** The device and all accessories in use during that treatment should be isolated and held for inspection. Make a note of treatment parameters that were in use during the treatment including intensity settings. Also note environmental factors that were observed during the treatment (office lights flickering, static electricity discharge, other devices in use on the same power source or in the same room, etc.)

The incident should be reported immediately to Dynatronics Customer Service at 1-800-874-6251. The customer service representative will inform you if it is necessary to send the device and/or accessories to Dynatronics for inspection.

Section VII

Service

Processor Interaction

Processor Interaction with the Keyboard and Displays

The keyboard is controlled by a microcontroller which scans the keys for key presses, keeps the displays updated, and reads any position from the XY pad. Periodically (several times per second) the main processor polls the keyboard processor, receiving status of any keys pressed or XY position, and updating the displays as required.

Processor Interaction with Oscillators

The processor controls the internal oscillators that generate the therapy wave forms. It initially calibrates the proper output frequencies during the test cycle, and then keeps track of the frequency the rest of the time the unit is on. If the oscillator happens to drift too far out of range for the processor to calibrate it, the processor will give an error message.

During the treatment, the processor causes the sweep frequency oscillator to change its frequency at a controlled rate. It chooses the rate and frequency from what is selected on the keyboard when the treatment is set up, or when changes are made during the treatment. It tracks and keeps the fixed frequency where it should be during the treatment. It also keeps track of the 2500 Hz signal that creates the Russian therapy (turns it on and off at a 50 Hz rate).

OSCILLATORS	
1	4 KHz fixed
2	4000-4010 Hz (Interferential Low option)
3	4080-4150 (Interferential High option)
4	2500 Hz (Russian)

Processor Interaction with the Output Jacks

The processor board controls the proper channeling of the output signals to the output jacks. The processor also activates and senses the relay that allows output from the unit.

Processor Control of Output Waveforms

The output waveforms are generated by a Digital Signal Processor on command from the main processor. Since the signals are digitally created, the accuracy of the waveform is derived from the crystal clock of the processor, whose accuracy is typically .001% or better. Both the output intensity as well as the frequency are digitally controlled through communication between the main and the Digital Signal processors.

Basic Trouble Shooting Techniques

Hands-On Testing Pads and Leads

NOTE: The following examples use the Beckman Circuitmate DM78 to show proper DVM use and safety precautions.

Leads may easily be tested without any special equipment by using the “Lead Test” function as discussed in the “Electrotherapy Usage Cautions” section of this manual. The DVM can also be used to see if the pads and leads are in good working condition. Electricity will always choose the path of least resistance to ground. If it does not have a good path or a complete circuit, it cannot flow and no stimulation will be felt. This is why good leads and pads are so important in the operation of the Dynatron electrotherapy device.

Prior to testing the leads, a test jack must be made. Any standard 1/4" stereo jack will work well. Call the service department at Dynatronics if you are unsure of what is needed. The test jack is made by shorting the connections for the patient lead together. These connections are inside of the jack and touch the patient lead as it is inserted into the jack. The connector that touches the **TIP** of the patient lead, and the connector that touches the small **RING** on the patient lead need to be soldered together (there is no connection to the ground contact).

To measure the continuity of the leads, turn the meter from OFF to the setting shown to “0000” figure (this is the continuity checker of the meter). Then plug the red and black leads of the DVM into the matching alligator clips, so that the meter lead fits into the round hole of the alligator clip.

Plug the lead that is being tested into a test jack. Clip the test leads of the meter, with the alligator clips, onto the free ends of the patient lead. The meter should beep continuously. Flex the lead at both ends and at the strain reliefs. Flex the main body of the lead to make sure that there are no opens or shorts in the lead. If the meter stops beeping at any time during the flexing, there is an open in the lead, and it should be replaced.

Test Lead and Pads

The carbon pads and poly electrodes can also be checked with the DVM. This is done with the resistance setting of the meter. Set the meter to “OO.OO.” After removing the alligator clips from the test leads of the meter, plug one of the test leads into the pin receptacle of the pad. Touch the other lead to the surface of the pad. If a resistance of more than 100 Ohms is seen, the pad is beginning to break down and should be replaced.

Installing Software Updates

Features and function of this device may be updated from time to time by the manufacturer. Such updates are installed via the “COM” port on the device using a handheld download device which is available from Dynatronics. It is recommended that a Dynatronics dealer perform the software update for you. This will ensure the software update is installed successfully, and will save you the expense of purchasing the separate download device. If you have registered your product warranty with the manufacturer, you will be notified of any software updates that may become available in the future.

Installing Replacement Parts

Since software updates for the Dynatron 950 plus and 650 plus are provided from an external connection, it is not necessary to replace the EPROM in the device. This device is not generally serviceable in the field. If you wish to perform any service on the device or replace any internal parts, you must first contact Dynatronics Customer Service for guidance.

Keep in mind that if the device is serviced or altered by anyone except authorized Dynatronics service personnel, the warranty on the device is invalidated.

For service assistance, contact Dynatronics’ Service Department at 1-800-874-6251.

Section VIII

Schematics and QC Check Lists

**DYNATRON 950/850 Plus STIM FINAL QUALITY CHECK (Q.C.)
CHECKOFF SHEET**

	<u>TECH/OC</u>	<u>(initials)</u>
1. INTERFERENTIAL: 42-55 Vpp	[]	[]
a) Static- High/Low (all channels) ± 4 Vpp		
b) Target/ Sweep (all channels)		
c) Modify Features (mode, time, function, cancel)		
d) Verify current limit 50mA maximum		
2. PREMODULATED 42-55 Vpp	[]	[]
a) High/Low (all channels)		
b) High/Low alternating (all channels)		
c) Modify Features (mode, time, cancel)		
d) Verify current limit 50mA maximum		
3. RUSSIAN STIM: 42-55 Vpp	[]	[]
a) One Channel Normal (all channels)		
b) Two Channel Reciprocal (channel pairs)		
c) Two Channel Co-contraction (channel pairs)		
d) Verify current limit 50mA maximum		
4. BI-PHASIC: 42-55 Vpp	[]	[]
a) One Channel Normal (all channels)		
b) Two Channel Reciprocal (channel pairs)		
c) Two Channel Co-contraction (channel pairs)		
d) Verify current limit 50mA maximum		
5. CHECK: labels, screws, chime, jacks, remote stop, micro probe conductance.	[]	[]
6. FUSE: verify rating (1.6 Amp slow-blow 250v)	[]	[]
7. VERIFY:	[]	[]
a) Custom Presets		
b) Check Lead Test, (target/sweep upon power up or function target after power up)		
c) Check lead warning		
d) Conductance bar graph		
8. Microcurrent:	[]	[]
a) Verify at 10 uA +/-10% and at 990 uA +/-1%		
b) Conductance changes with and without a load, notice audible tone change.		
c) Verify the polarity changes.		
d) Verify microcurrent conductance bar graph		
9. High volt: (950+, 2-ch's; 850+, 1-ch)	[]	[]
a) Without load, verify 500 volts (-10%)		
b) Conductance		
c) Verify that polarity changes.		

FAILURES

Step No. _____
Reason _____
Repaired _____
Technician _____ Date ____/____/____

ACCEPTANCE:

Technician _____ Date ____/____/____
QC Inspector _____ Date ____/____/____

**DYNATRON 950/850 Plus FINAL QUALITY CHECK (QC)
CHECKOFF SHEET**

Unit S/N _____ Software Version _____ Date __/__/__

Repair _____ RS _____ Production _____

Head SN: 5cm _____ 10cm _____ 2cm _____ 1cm _____

Refer to Test equipment operation manual and unit operating instructions/ manuals.

TECH/OC

(initials)

- Verify all keys work, all keys have good tactile feel () ()
- Verify all LED's light up () ()

- Verify output turns off when STOP is pressed () ()
- Verify head temperature bar graph works () ()
- Verify coupling bar graph works with 5cm smart soundhead () ()

- Verify unit and soundhead serial number () ()
- Verify stim jack is tight () ()
- Combo with stim: Verify stim output through soundhead, using combo cable ()
()
- Verify ultrasound output power (for each head) per table below: ()

5cm	2.5 Watts (0.5)	5 Watts (1.0)	10 Watts (2.0)
1 MHz	2.4 – 2.6	4.9 – 5.1	9.8 – 10.2
2 MHz	2.4 – 2.6	4.9 – 5.1	9.8 – 10.2
3 MHz	2.4 – 2.6	4.9 – 5.1	9.8 – 10.2

10cm	5 Watts (0.5)	10 Watts (1.0)	20 Watts (2.0)
1 MHz	4.9 – 5.1	9.8 – 10.2	19.0 – 20.4
2 MHz	4.9 – 5.1	9.8 – 10.2	19.0 – 20.4
3 MHz	4.9 – 5.1	9.8 – 10.2	XXXXXXXX

2cm	1 Watt (0.5)	2 Watts (1.0)	4 Watts (2.0)
1 MHz	0.9 – 1.1	1.9 – 2.1	3.9 – 4.1
2 MHz	0.9 – 1.1	1.9 – 2.1	3.9 – 4.1
3 MHz	0.9 – 1.1	1.9 – 2.1	3.9 – 4.1

1cm	1 Watt (1.0)	1.5 Watts (1.5)	2 Watts (2.0)
2 MHz	0.9 – 1.1	1.4 – 1.6	1.9 – 2.1
3 MHz	0.9 – 1.1	1.4 – 1.6	XXXXXXXX

Ground Fault

Chassis leakage not to be greater than 75 uA, and on leads 20 uA:

Leakage no ground chassis _____ leads _____ chassis _____ leads _____
Leakage grounded chassis _____ leads _____ chassis _____ leads _____
Hot/Return reversed chassis _____ leads _____ chassis _____ leads _____

ACCEPTANCE:

DYNATRON 650/550 PLUS and PLUS E FINAL QUALITY CHECK

Unit S/N _____	Software Ver. _____	Date ___/___/___	TECH/QC
<i>Repair</i> _____	<i>RS</i> _____	<i>Production</i> _____	(Initials)
1. Verify all LED's light, all key presses function and have good tactile feel.			[] []
2. INTERFERENTIAL: 42-55 Vpp			[] []
a) Static- High/Low (all channels) ± 4Vpp			
b) Target/ Sweep (all channels)			
c) Modify Features (mode, time, function, cancel)			
d) Verify current limit 50 mA maximum			
3. PREMODULATED 42-55 Vpp			[] []
a) High/Low (all channels)			
b) High/Low alternate (all channels)			
c) Modify Features (mode, time, cancel)			
d) Verify current limit 50 mA maximum			
4. RUSSIAN STIM: 42-55 Vpp			[] []
a) One Channel Normal (all channels)			
b) Two Channel Reciprocal (channel pairs)			
c) Two Channel Co-contraction (channel pairs)			
d) Verify current limit 50 mA maximum			
5. BI-PHASIC: 42-55 Vpp			[] []
a) One Channel Normal (all channels)			
b) Two Channel Reciprocal (channel pairs)			
c) Two Channel Co-contraction (channel pairs)			
d) Verify current limit 50 mA maximum			
6. CHECK: labels, screws, chime, jacks, remote stop micro probe conductance.			[] []
7. FUSE check rating (1.6/0.8 Amp slow-blow 250v)			[] []
8. VERIFY:			[] []
a) Custom Presets			
b) Check Lead Test, (target/sweep upon power up or function target after power up)			
c) Check lead warning			
d) Conductance bar graph			
e) Labels			
9. Microcurrent:			[] []
a) Verify 10uA +/-10% and 990uA +/- 1%			
b) Conductance changes with and without a load, notice audible tone change.			
c) Verify the polarity changes.			
d) Verify microcurrent conductance bar graph			
10. High volt: (650+, 2-ch's/550+ 1 ch).			[] []
a) Without load verify 500 volts (-10%)			
b) Conductance			
c) Verify the polarity changes			
<u>Ground Fault</u>			
Chassis Leakage not be greater than 200uA, and on leads 20uA.			
11. Leakage no ground	chassis _____	leads _____	chassis _____ leads _____
12. Leakage grounded	chassis _____	leads _____	chassis _____ leads _____
13. Hot/Return reversed	chassis _____	leads _____	chassis _____ leads _____
<u>FAILURES</u>		<u>ACCEPTANCE:</u>	
Step No. _____	Technician _____	Date ___/___/___	
Reason _____	QC Inspector _____	Date ___/___/___	

MASTER

ADDRESSING:
 LCS: NOT USED (NO ALLOCATION)
 MCSB: 00000 - 1FFFF RAM
 MCS1: 20000 - 3FFFF (NOT USED)
 UCS: E0000 - FFFFF BOOT ROM

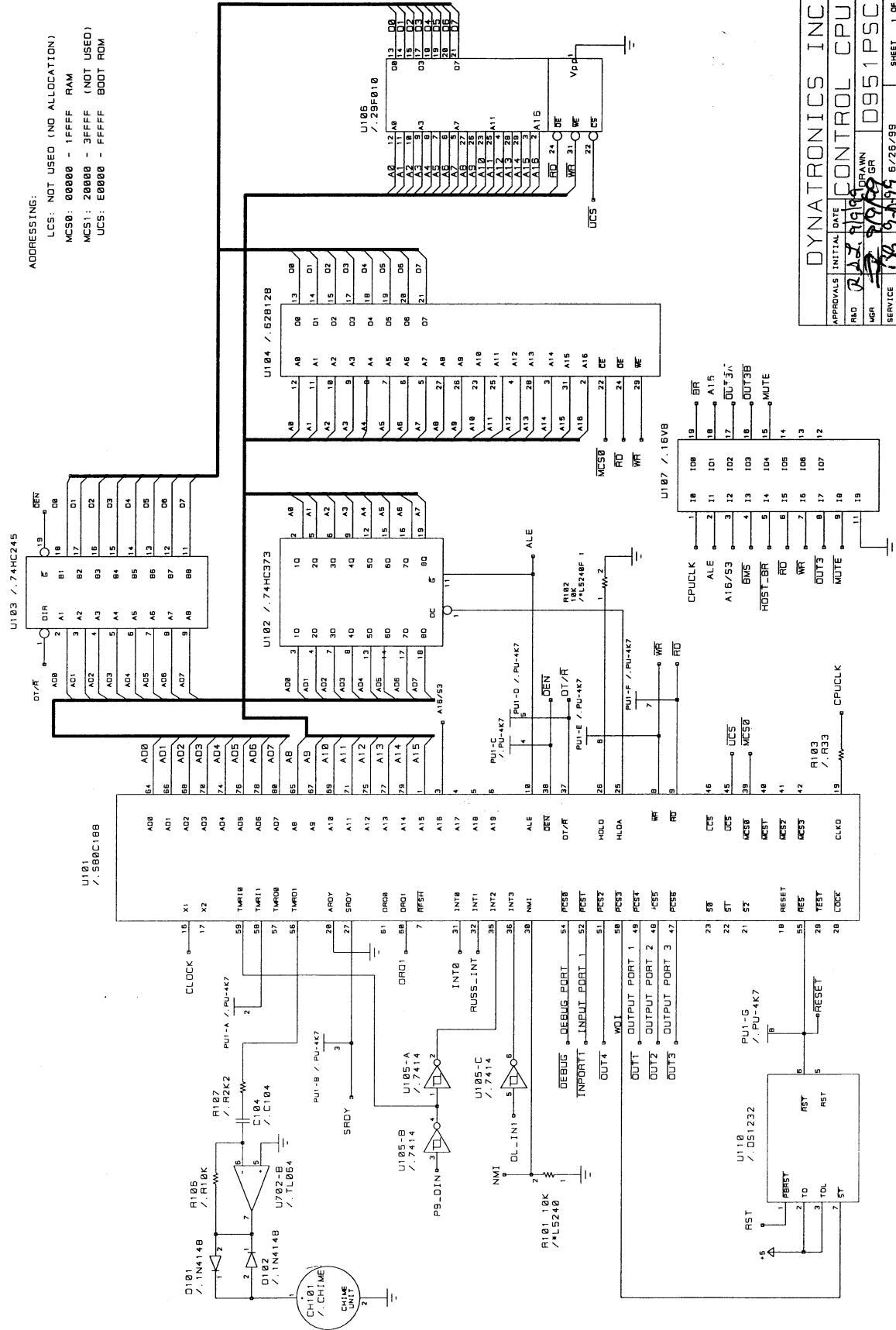

DYNATRONICS INC	
APPROVALS	INITIAL DATE
RAD	9/15/89
DESIGNED BY	CONTROL CPU
DRAWN	GR
REV	D951PSC
SERVICE	138
DATE	6/26/99
SHEET	1 OF 11

MASTER

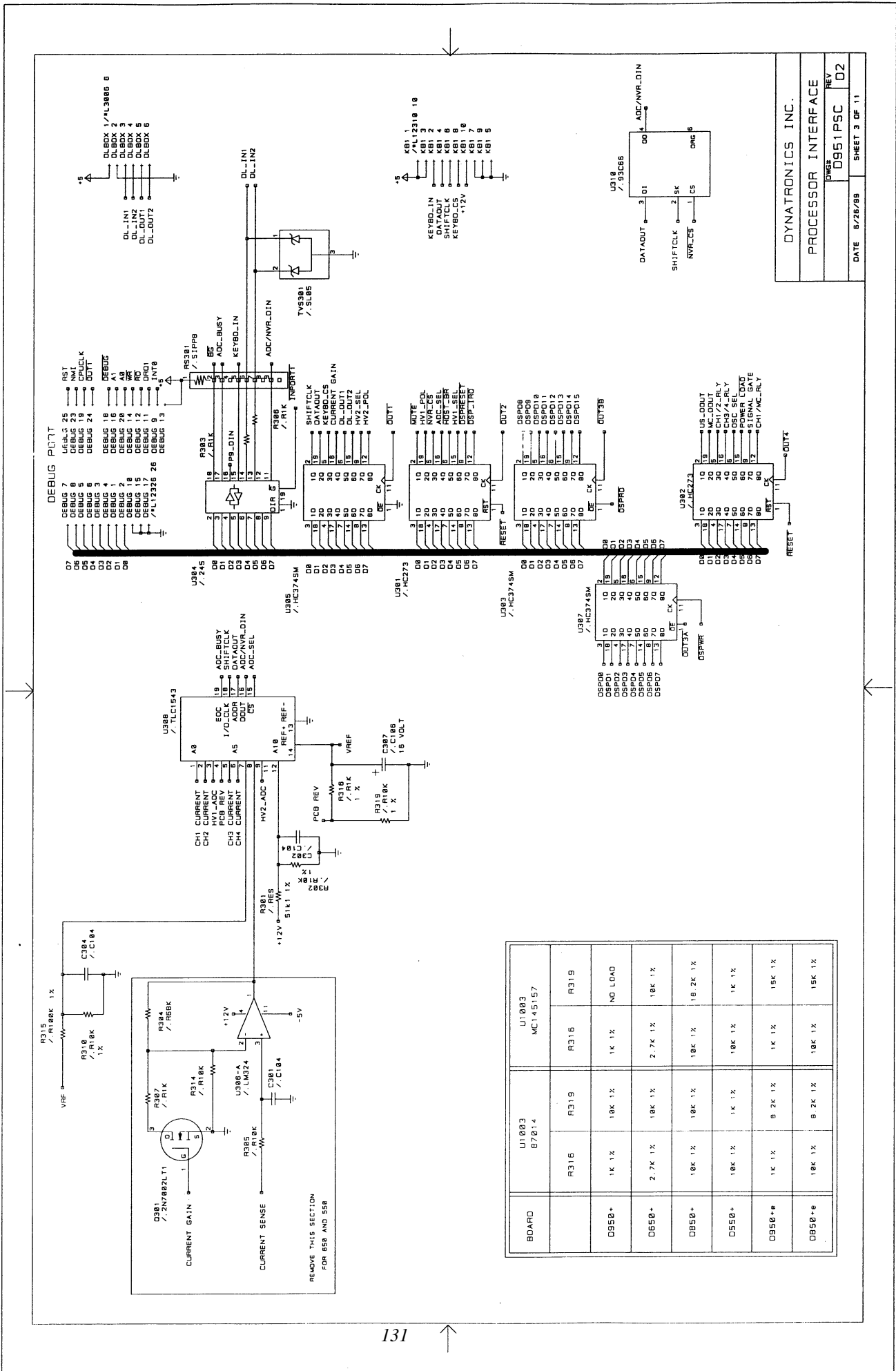

DYNATRONICS INC.	
PROCESSOR INTERFACE	
DATE	8/26/89
REV	D2
UWG	D951P5C
SHEET 3 OF 11	

BOARD	U1003	U1003	U1003	U1003	U1003	U1003	U1003
	B7214	R316	R319	R316	R319	R316	R319
D950*	1K 1X	10K 1X	1K 1X	1K 1X	NO LOAD	18 2K 1X	15K 1X
D650*	2.7K 1X	10K 1X	10K 1X	2.7K 1X	10K 1X	10K 1X	15K 1X
D850*	10K 1X	10K 1X	10K 1X	10K 1X	10K 1X	18 2K 1X	15K 1X
D550*	10K 1X	10K 1X	1K 1X	10K 1X	10K 1X	1K 1X	15K 1X
D950*#	1K 1X	9 2K 1X	1K 1X	1K 1X	1K 1X	15K 1X	15K 1X
D850*#	10K 1X	8 2K 1X	10K 1X	10K 1X	10K 1X	15K 1X	15K 1X

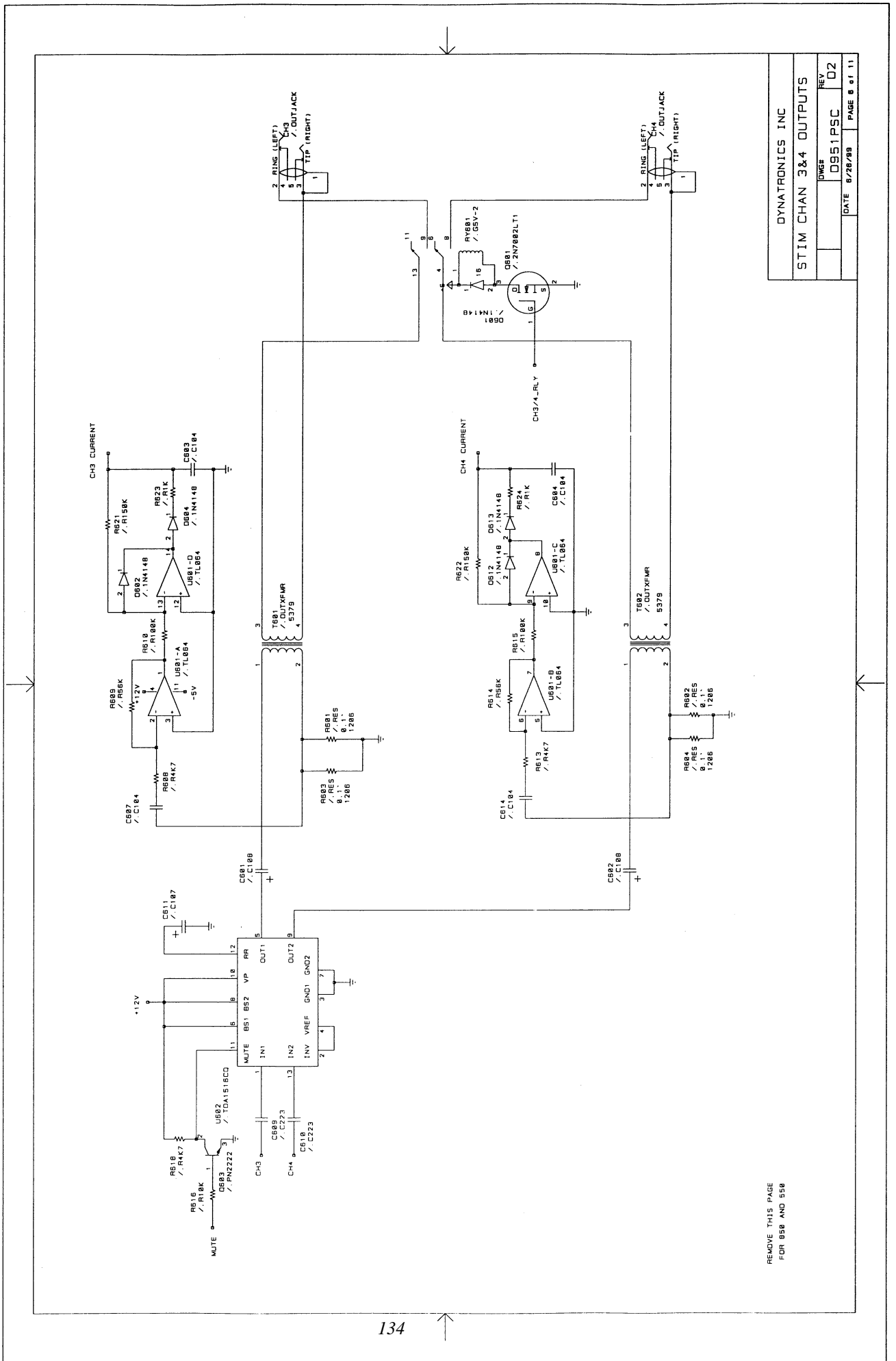

REMOVE THIS PAGE
FOR 856 AND 558

DYNATRONICS INC	
STIM CHAN 3&4 OUTPUTS	
DWG#	D951PSC
REV	02
DATE	8/28/99
PAGE	6 of 11

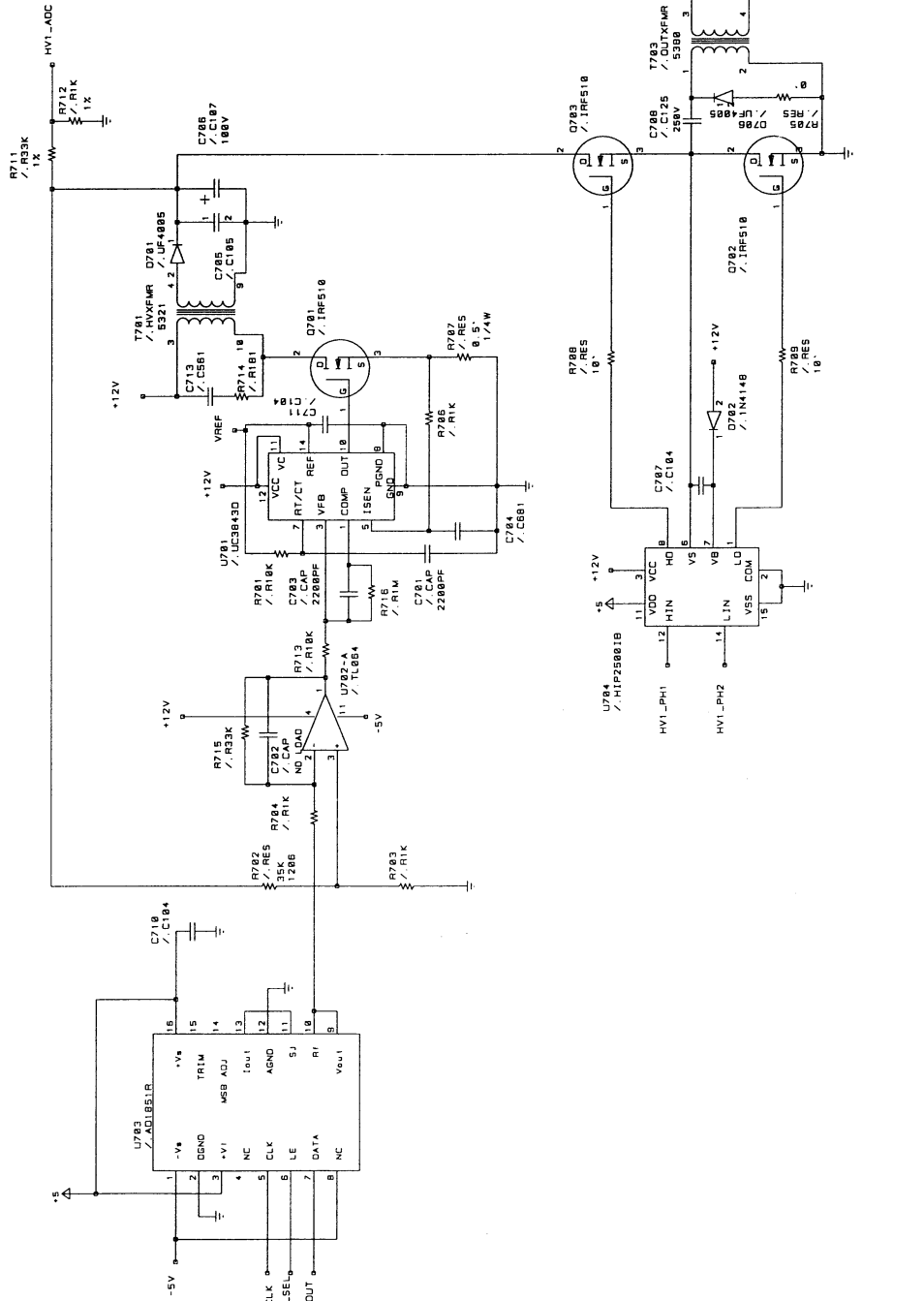

DYNATRONICS INC.	
HI VOLT 1	REV
DWG# D951P02	REV 02
DATE 6/28/99	SHEET 7 OF 11

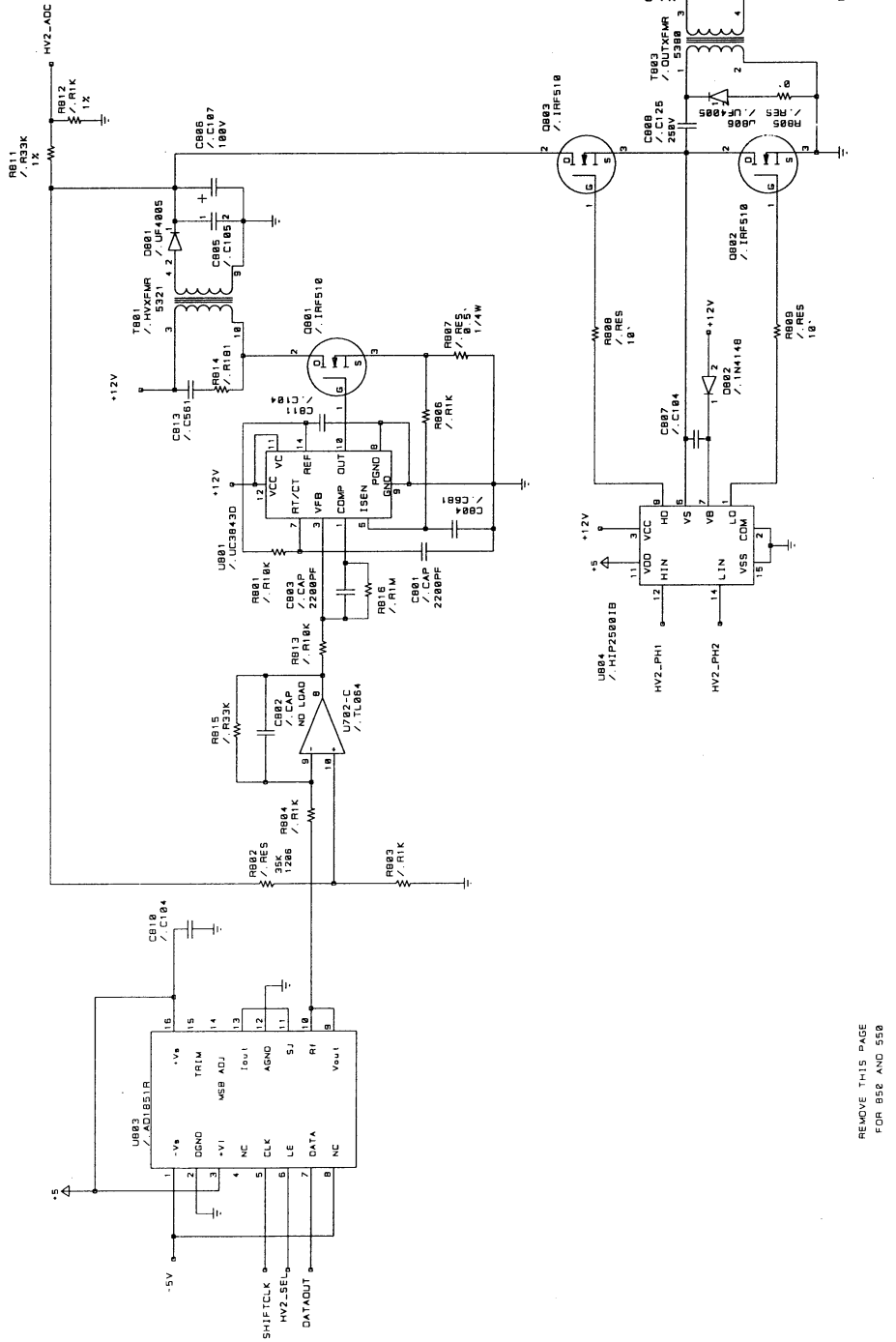

NOTE: HV001 SHOWN DE-ENERGIZED
SOFTWARE DEFAULT ENERGIZED

REMOVE THIS PAGE
FOR 552 AND 558

DYNATRONICS INC.

HI VOLT 2

DATE 8/26/99

REV D951PSC 02

SHEET 8 OF 11

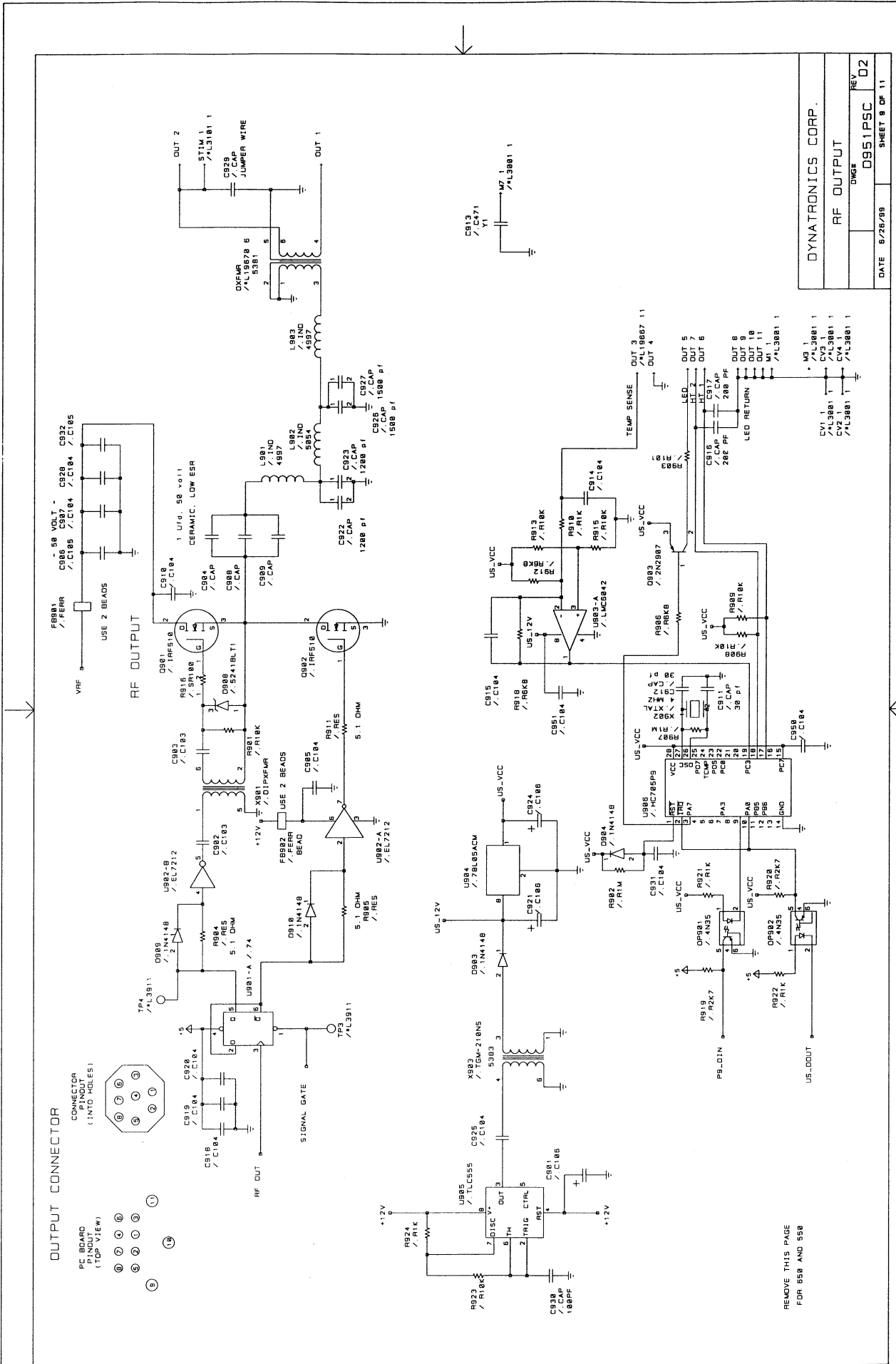

OUTPUT CONNECTOR
 CONNECTOR
 (INTO HOLES 1)

PC BOARD
 PINOUT
 (TOP VIEW)

① ② ③ ④ ⑤ ⑥ ⑦ ⑧

REMOVE THIS PAGE
 FOR 558 AND 559

DYNATRONICS CORP.	
RF OUTPUT	
DATE	8/26/89
DWG#	0951PSC 02
REV	
SHEET 9 OF 11	

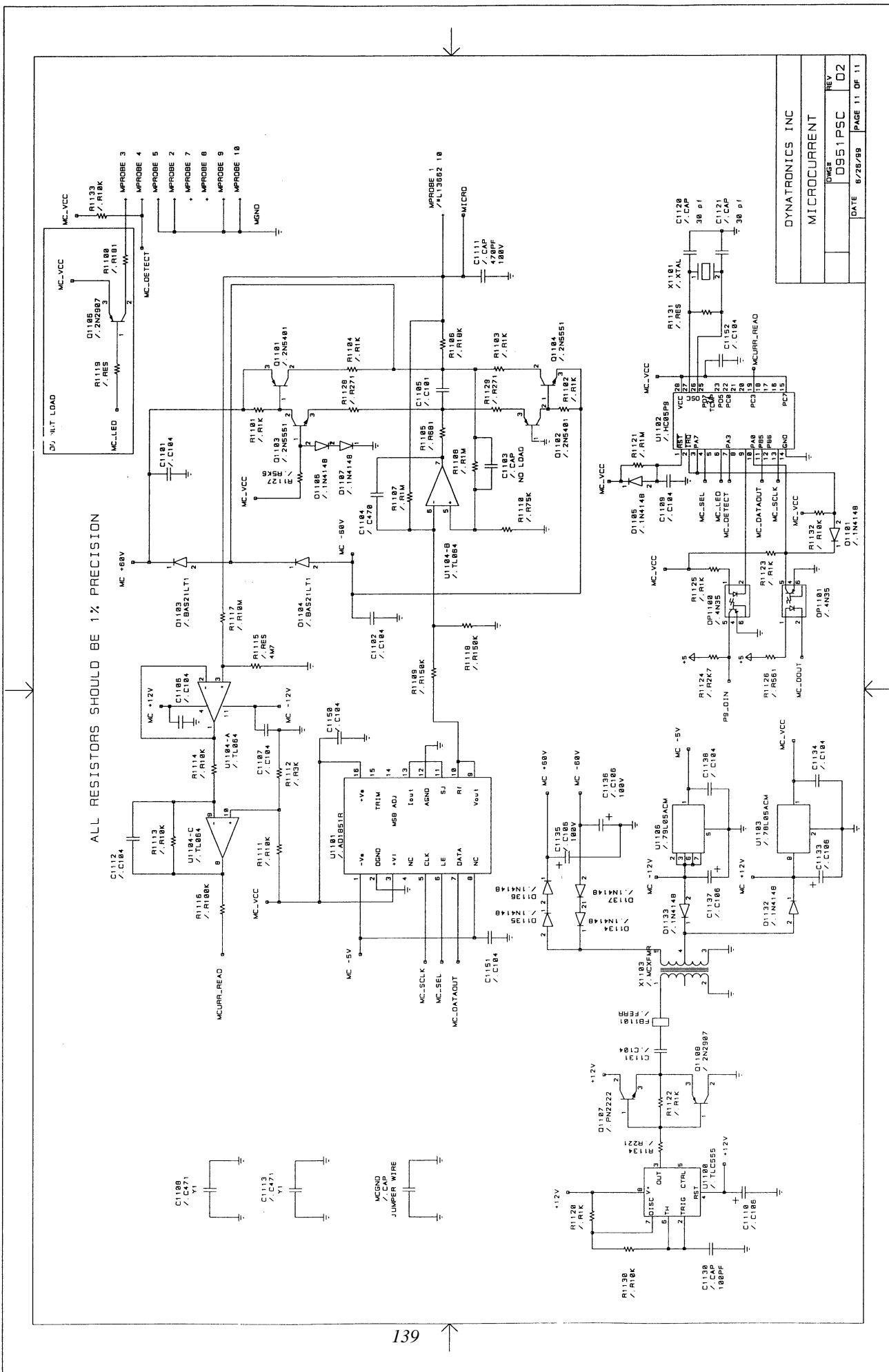

ALL RESISTORS SHOULD BE 1% PRECISION

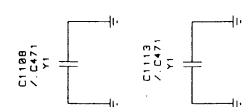

MASTER

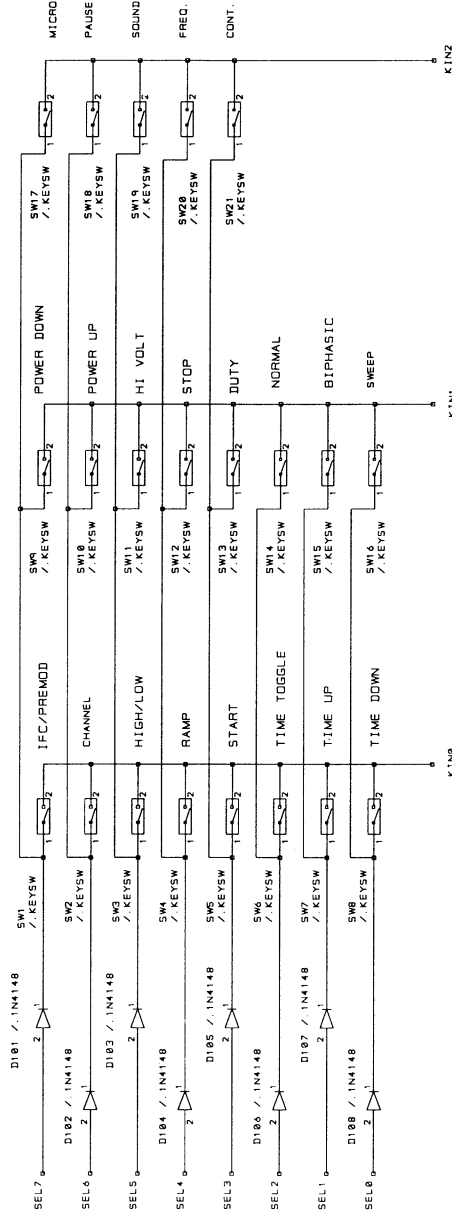

APPROVALS		INITIAL	DYNATRONICS INC	
DEPT	DATE		50+ KEY SCAN	
R&D	11/12/76	K/S	DWG# D450PP1	
DESIGN		T.K.	REV B	
MANAGER		B/S	DATE	SHEET 1 OF 3

Doc: D451D5C

MASTER

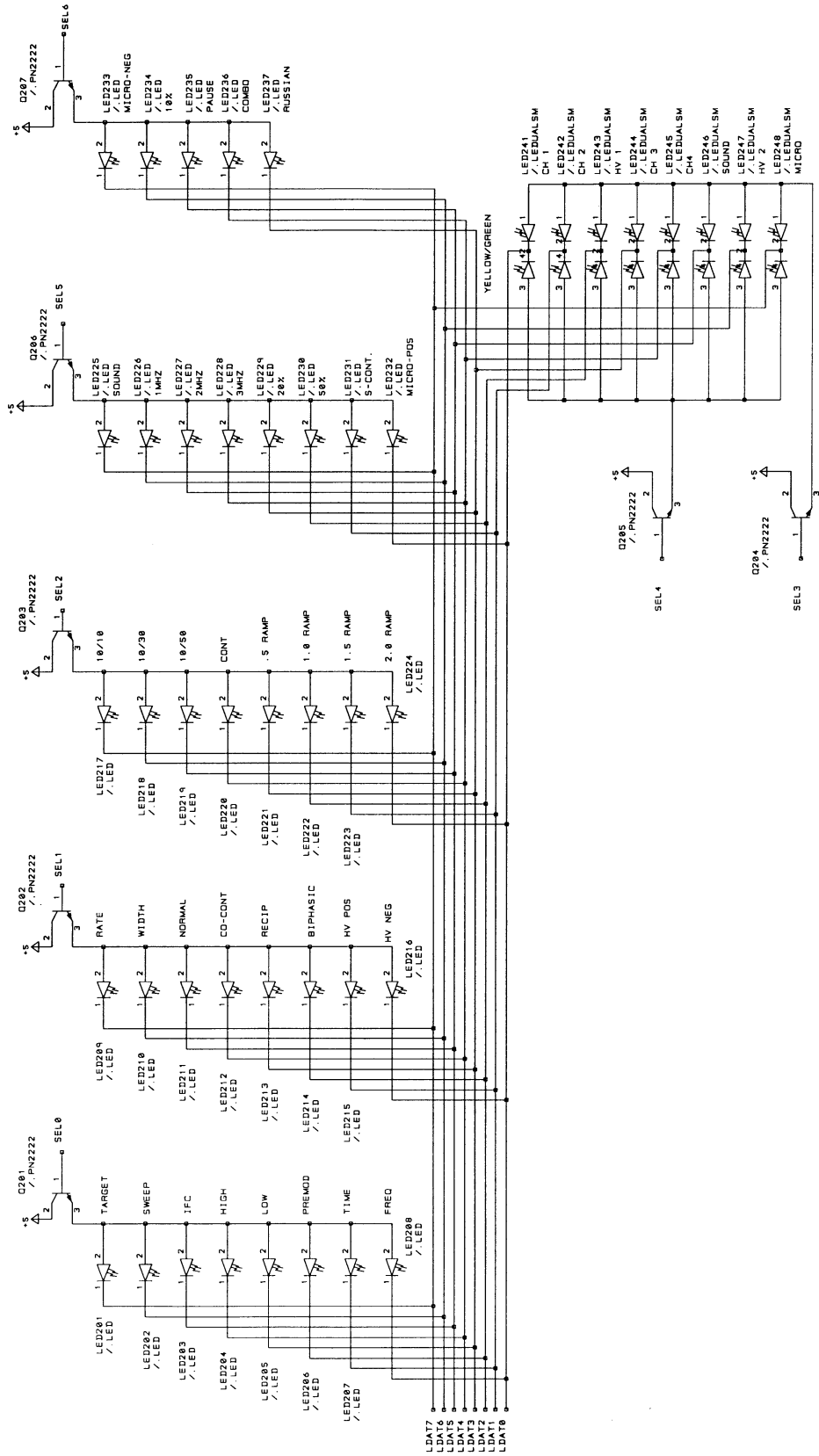

DYNATRONICS INC		
S0+ DISCRETE LEDES		
DWG#	REV	
D950FP2	B	
DATE	11/6/96	SHEET 2 OF 3

Doc: D951DSC
T.K. 3/5/97

MASTER

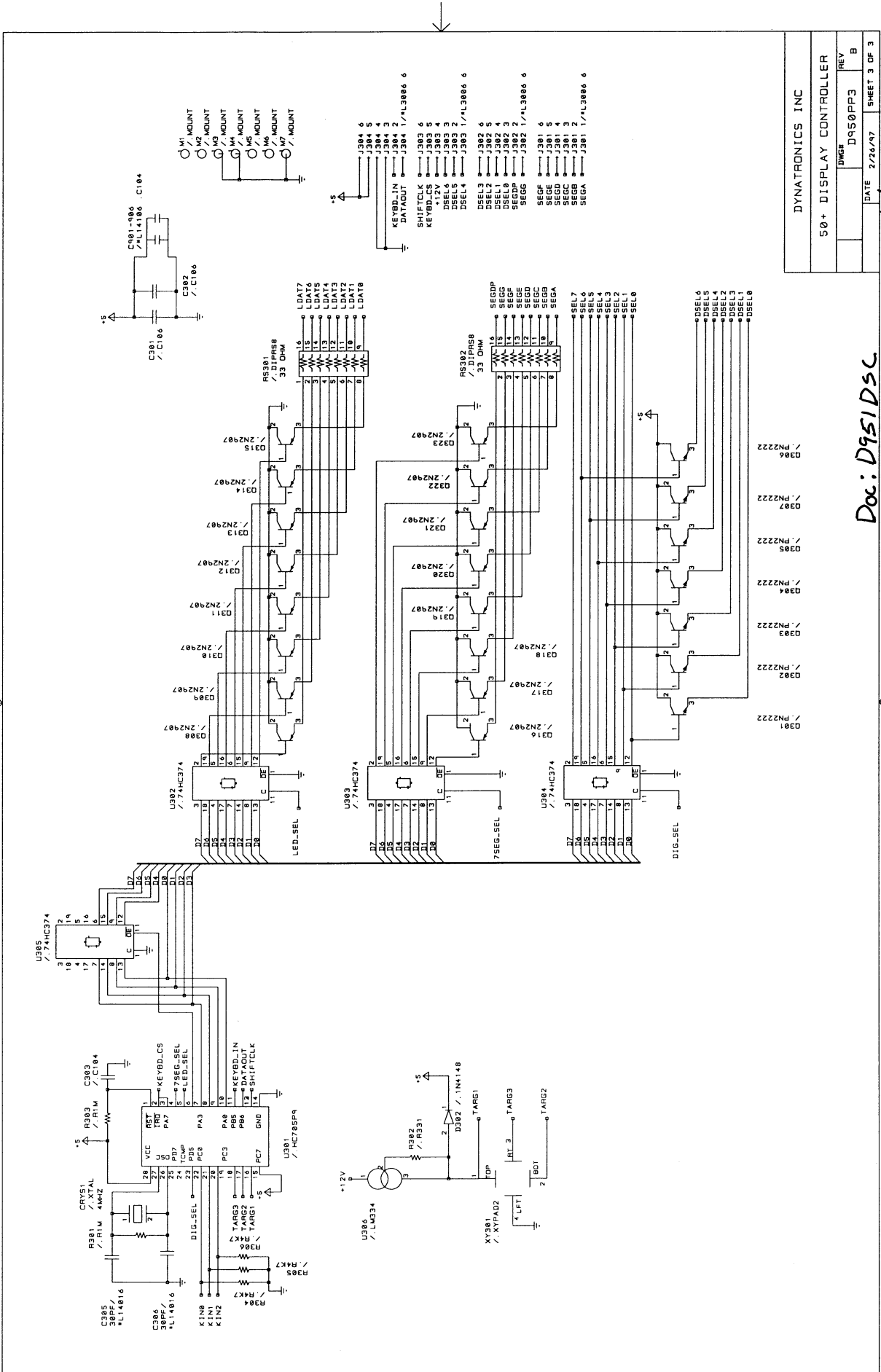

DYNATRONICS INC	
50+ DISPLAY CONTROLLER	
DWG#	D950PP3 REV B
DATE	2/26/97
SHEET 3 OF 3	

Doc: D951D5C

Tk 8/5/97

