

New as of: 09.2017

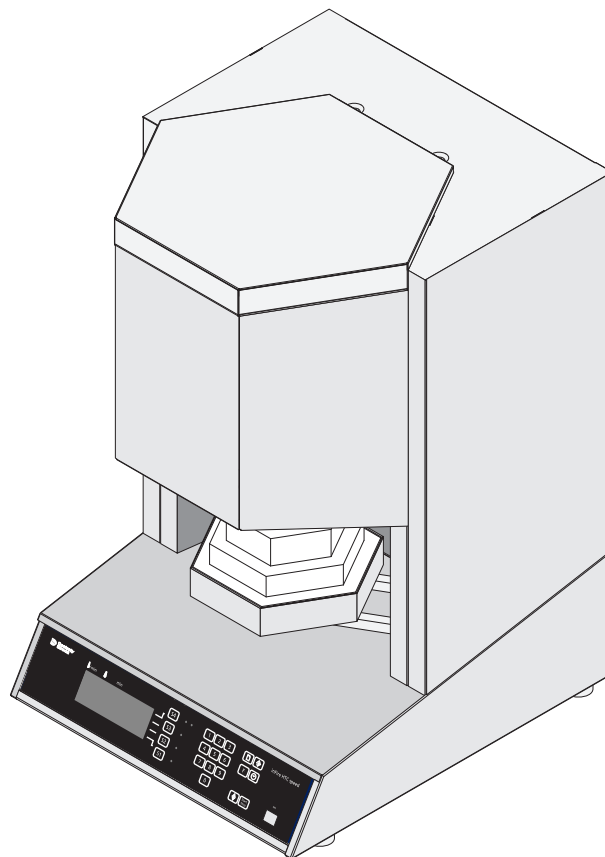

inFire HTC speed

Operating Instructions

English



Contents

| | | |
|----------|---|----|
| 1 | Dear customer,..... | 5 |
| 2 | General data..... | 6 |
| | 2.1 Structure of the document..... | 6 |
| | 2.1.1 Identification of the danger levels..... | 6 |
| | 2.1.2 Formats and symbols used..... | 7 |
| | 2.2 Warranty..... | 7 |
| 3 | Safety information..... | 8 |
| 4 | Technical description..... | 11 |
| | 4.1 Description of the furnace..... | 11 |
| | 4.2 Certification..... | 12 |
| | 4.3 Intended use..... | 12 |
| | 4.4 Technical data..... | 13 |
| 5 | Setup..... | 14 |
| | 5.1 Installation site..... | 14 |
| | 5.2 Electrical connection..... | 15 |
| 6 | Operation..... | 17 |
| | 6.1 Controls and displays..... | 17 |
| | 6.1.1 Key functions..... | 18 |
| | 6.1.2 Description of the standby display..... | 18 |
| | 6.2 Switching on the unit..... | 19 |
| | 6.3 Practical use..... | 19 |
| | 6.3.1 Initial startup..... | 20 |
| | 6.3.2 Sintering zirconium oxide..... | 20 |
| | 6.3.2.1 Preparing the sintering tray..... | 20 |
| | 6.3.2.2 Preparing the furnace door..... | 21 |
| | 6.3.3 Program selection..... | 26 |
| | 6.3.4 Loading a program..... | 26 |
| | 6.3.5 Starting the program..... | 26 |
| | 6.3.6 Lifting the sintering tray out of the furnace..... | 26 |
| | 6.4 Operating modes..... | 26 |
| | 6.4.1 Super speed sintering (program starts at 1,580 °C / 2,876 °F, pre- heating required) | 26 |
| | 6.4.1.1 Performing super speed sintering..... | 27 |
| | 6.4.2 Speed sintering (program starts at room temperature, no pre- heating required) | 29 |

| | | |
|---------|---|----|
| 6.4.3 | Classic sintering (program starts at room temperature, no pre-heating required) | 30 |
| 6.5 | Non-precious metal (NPM) sintering (optional) | 30 |
| 6.5.1 | Safety instructions | 30 |
| 6.5.1.1 | Basic information | 30 |
| 6.5.1.2 | Use of argon in the inFire HTC speed with gas management module | 31 |
| 6.5.2 | Scope of supply | 32 |
| 6.5.2.1 | Retrofitting a gas management module | 32 |
| 6.5.3 | Enhanced program list | 32 |
| 6.5.4 | Connecting the argon supply | 32 |
| 6.5.5 | Sintering pre-sintered NPMs (CoCr-base) | 33 |
| 6.5.6 | Loading the furnace with the inCoris CC set, from serial number >5000 | 35 |
| 6.5.7 | Replacing the furnace door (only for devices with serial numbers < 5000)> | 37 |
| 6.6 | Programs | 38 |
| 6.6.1 | Plan for assigning furnace programs | 38 |
| 6.6.2 | Fixed programs | 39 |
| 6.6.3 | Select program number/load program | 39 |
| 6.6.4 | Starting the program | 40 |
| 6.6.5 | Starting a program with the Casting-Time function | 40 |
| 6.6.6 | Freely programmable programs | 40 |
| 6.6.6.1 | Entering program values | 40 |
| 6.6.6.2 | Entering the program values for fast sintering (speed sintering) | 42 |
| 6.6.6.3 | Programming example for fast sintering (speed sintering) | 42 |
| 6.6.6.4 | Storing program values | 43 |
| 7 | Default settings | 44 |
| 7.1 | Display and acoustic signal | 44 |
| 7.2 | Adjustment of the start time (casting time function) | 45 |
| 8 | Description of special functions | 46 |
| 8.1 | Sintering with ventilation (sintering with a small air gap) | 46 |
| 8.2 | Sintering with pre-drying (sintering with a large air gap) | 46 |
| 8.3 | Pre-drying without sintering | 46 |
| 8.4 | Sintering with defined cooling | 46 |
| 9 | Regular care | 47 |
| 9.1 | General care instructions | 47 |
| 9.2 | Sirona service program | 47 |

| | | |
|-----------|---|----|
| 10 | Maintenance..... | 48 |
| 10.1 | Changing fuses F1/F2..... | 48 |
| 10.2 | Replacing the battery (only for devices with serial numbers < 5000)>..... | 49 |
| 10.3 | Furnace chamber insulation..... | 49 |
| 11 | Malfunctions..... | 50 |
| 11.1 | Error messages from electronic components..... | 50 |
| 11.2 | Miscellaneous errors and their causes..... | 51 |
| 12 | Disposal..... | 52 |
| | Index..... | 53 |

1 Dear customer,

Thank you for purchasing your inFire HTC speed high-temperature furnace from Sirona.

It will support you with your work for many years, as it was developed and built with state-of-the-art technology.

Nevertheless, improper use and handling can cause damage and hazards. Please read and follow these operating instructions carefully. Always keep them within easy reach.

To prevent personal injury or material damage, it is important to observe all safety information.

Your inFire HTC speed Team

2 General data

Please read this document completely and follow the instructions exactly. You should always keep it within reach.

Original language of the present document: German.

2.1 Structure of the document

2.1.1 Identification of the danger levels

To prevent personal injury and material damage, please observe the warning and safety information provided in these operating instructions. Such information is highlighted as follows:

DANGER

An imminent danger that could result in serious bodily injury or death.

WARNING

A possibly dangerous situation that could result in serious bodily injury or death.

CAUTION

A possibly dangerous situation that could result in slight bodily injury.

NOTICE

A possibly harmful situation which could lead to damage of the product or an object in its environment.

IMPORTANT

Application instructions and other important information.

Tip: Information for simplifying work.

2.1.2 Formats and symbols used

The formats and symbols used in this document have the following meaning:

| | |
|---|---|
| ✓ Prerequisite 1. First action step 2. Second action step or > Alternative action ↵ Result ➤ Individual action step | Prompts you to do something. |
| See "Formats and symbols used [→ 7]" | Identifies a reference to another text passage and specifies its page number. |
| • List | Designates a list. |
| "Command / menu item" | Indicates commands, menu items or quotations. |

2.2 Warranty

The sinter support is excluded from the warranty as it is a consumable item.

3 Safety information

Perform connection by following the directions given in the present operating instructions.

As manufacturers of dental and laboratory equipment and in the interest of the operational safety of your system, we stress the importance of having maintenance and repairs performed exclusively by our own personnel or through our authorized representatives. Furthermore, safety-critical system components must always be replaced with original spare parts.

We suggest that you request a certificate specifying the nature and extent of the work performed from the persons who performed it. Furthermore, the certificate should also include any possible changes in rated parameters or working ranges as well as the date, the name of the firm and a signature.

Modifications to this system which may affect the safety of the operator or third parties are prohibited by law.

For reasons of product safety, this product may be operated only with original Sirona accessories or third-party accessories expressly approved by Sirona. The user is responsible for any damage resulting from the use of non-approved accessories.

If any equipment not approved by Sirona is connected, it must comply with the applicable standards:

- EN 60 950 for information technology equipment, and
- EN 61 010-1 for laboratory equipment.

CAUTION

Liability exclusion for any other use

The inFire HTC speed high-temperature furnace is exclusively intended for sintering oxide ceramics for use in dental technology. We are not liable for damages due to any other use.

The inFire HTC speed high-temperature furnace with integrated gas management system and associated accessories enable the sintering of pre-sintered non-precious metals.

CAUTION

Risk due to improper operation

The inFire HTC speed high-temperature furnace may only be operated by employees who are familiar with the content of these operating instructions. Signs and labels on the laboratory furnace must be kept in legible condition at all times. They may not be removed.

 **CAUTION**

Risk due to incorrect setup

The inFire HTC speed high-temperature furnace may only be set up in dry rooms and must never be in contact with any liquids. Furniture items and other equipment in the vicinity of the furnace must not contain any explosive, flammable or easily ignitable materials. It is prohibited to keep or store ignitable or flammable gases or liquids in the room where the furnace is set up.

 **CAUTION**

Damage resulting from unauthorized alterations

The inFire HTC speed high-temperature furnace may only be altered with our express prior approval. We are not liable for unauthorized alterations of any kind.

- Switch the unit off and disconnect the power plug prior to performing maintenance tasks.

 **WARNING**

Separate circuit

The inFire HTC speed high-temperature furnace must always be connected to a separate circuit with at least a 16A fuse. The fuses must be of the **C** type.

 **WARNING**

Risk of burns due to objects falling out

As there is a serious risk of burns in this case, it is essential to install a fire-proof table and floor covering.

I. For safety reasons, the furnace must be operated when standing. Only in this way is it possible for the user to quickly avoid parts that fall out.

II. When using super speed sintering, wearing heat-resistant protective clothing is recommended. In accordance with professional association regulations, the operator of the site is responsible for providing the user with appropriate protective clothing.

III. The operator of the site is responsible for giving the user appropriate safety instructions.

IV. If a fracture occurs during the sintering process as a result of a failure to adhere to the recommended drying procedure, there is a risk that hot objects will fall out as soon as the furnace door is opened.

V. The furnace should only be loaded and unloaded using the crucible fork. For safety reasons, a trained user must be present when the furnace is being loaded or unloaded.

 **WARNING****Risk of burns due to hot surfaces**

The inFire HTC speed high-temperature furnace may develop hot surfaces in some areas after extended use. Use the necessary caution around the unit, especially when the furnace is operated for extended periods.

- Never touch the hot surfaces.

 **WARNING****Risk of burns due to hot surfaces**

Once the program has ended and the furnace has shut down, the cooling fan will run until the interior temperature of the furnace has been reduced to normal. The power plug may not be disconnected prior to this point.

 **WARNING****Fire hazard due to covering ventilation slots on the upper side of the casing**

Covered ventilation slots can overheat the furnace and cause the object placed on top to ignite.

- Do not place any objects on the casing upper side.

Note on the prevention, recognition and elimination of unintended electromagnetic effects

This device is a piece of electrical equipment with a supply voltage below 1000 VAC and is intended for commercial use. It is to be installed in dental laboratories or other areas with a controlled electromagnetic environment. The applicable EMC requirements comply with EN 61326:2006.

4 Technical description

4.1 Description of the furnace

The heating system consists of six high-quality MoSi₂ heating elements. Thanks to the excellent interior insulation, the energy consumption of the unit is low.

The furnace is equipped with a safety feature that prevents the uncontrolled opening of the furnace.

The HT sensor is equipped with a thermocouple burn-off device which prevents the furnace from accidental overheating in the case of a sensor defect.

The furnace is equipped with current control which allows it to heat up extremely quickly. This means that the furnace can reach the desired pre-heating temperature in the shortest possible time.

Please refer to the rating plate at the rear of the device for information about the model.

4.2 Certification



CE mark

This product bears the CE mark in accordance with the provisions of Council Directive 2006/42/EC (machinery directive).

CAUTION

CE mark for connected products

Further products which are connected to this unit must also bear the CE mark. These products must be tested according to the applicable standards.

We declare conformity for the inFire HTC speed ceramic sintering furnace on the basis of the following standards:

- Safety: IEC 61010-1:2001 2nd edition and IEC 61010-2-010:2003 2nd edition
- EMC: EN 61326:2006
- Risk assessment and risk reduction EN ISO 12100:2010

EAC certification

Mark of conformity of the Eurasian Economic Community



RoHS compliance

This symbol indicates that this product does not contain any toxic or hazardous substances or components above the maximum concentration value set out in the Chinese standard SJ / T 11364-2014, and can be recycled following disposal and should not be carelessly discarded.



4.3 Intended use

The inFire HTC speed high-temperature furnace is exclusively intended for sintering oxide ceramics for use in dental technology at up to 1,650 °C (3,002 °F).

In addition to the sintering of oxide ceramics, with an integrated or retrofitted gas management system the sintering of pre-sintered non-precious metals is also possible.

4.4 Technical data

| | |
|---|---|
| Model designation: | inFire HTC speed |
| Type of protection against electric shock: | Protection Class I device |
| Degree of protection against ingress of water: | Ordinary device (without protection against ingress of water) |
| Setup location: | Indoors in dry area |
| Height | up to 2000 m |
| Temperature range: | 5 °C to 40 °C (41 °F to 104 °F) |
| Relative humidity | 80% up to 31 °C (87.8 °F), above this decreasing linearly to 50% at 40 °C (104 °F), no condensation |
| Overvoltage category: | II |
| Pollution degree: | 2 |
| Mode of operation | Continuous operation |
| Dimensions of unit (W x H x D in mm): | 500 x 820 x 565 |
| Dimensions of packaged unit (W x H x D in mm): | 630 x 1300 x 730 |
| Furnace chamber: | Diameter 130 mm x 80 mm height |
| Maximum sintering temperature: | 1,650 °C (3,002 °F) |
| Approx. weight without packaging: | 80 kg |
| Approx. weight including packaging: | 96 kg |
| Maximum inlet pressure: (applies to all devices with built-in gas management module) | 8 bar |
| Rated line voltage (all units except REF: 6401462 and 6416247): | 200 V AC – 240 V AC |
| Rated line frequency (all units except REF: 6401462 and 6416247): | 50/60Hz |
| Rated current consumption (all units except REF: 6401462 and 6416247): | 15 A |

Only for REF: 6401462 and 6416247

| | |
|----------------------------|--|
| Rated line voltage: | 220 VAC – 230 VAC |
| Rated power frequency: | 50/60Hz |
| Rated current consumption: | 13A |
| Maximum inlet pressure: | 10 bar (applies to all devices with built-in gas management module) |

5 Setup

5.1 Installation site

The unit is designed for desktop use and requires a level footprint of approx. 500 x 600 mm with a loading capacity of 80 kg.

The unit must not be installed at sites with a high level of humidity or dust!

- Always set up the unit in a dry location, as specified in the safety information.

NOTICE

Danger of overheating

If the unit overheats, the electronics switch off.

- Never obstruct the ventilation slots!
- Provide ventilation clearance on all sides.
- A minimum clearance of 500 mm must be adhered to, above and to the sides.

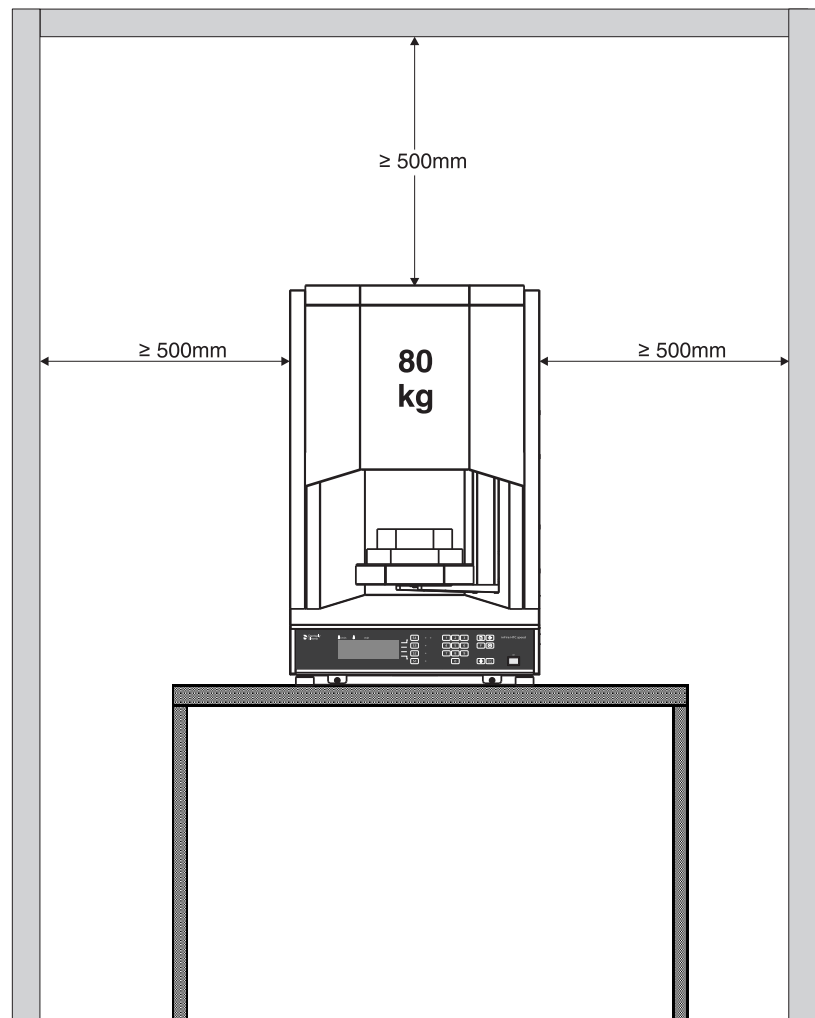

5.2 Electrical connection

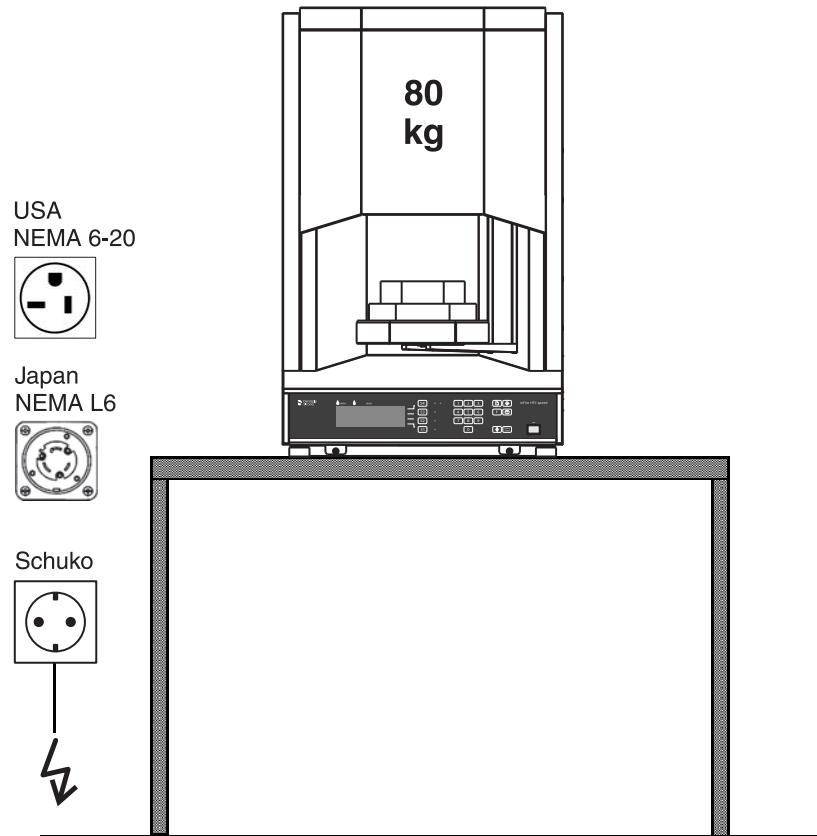

Building installation

The following electrical installation requirements are to be fulfilled for the high-temperature inFire HTC speed furnace:

- The furnace requires a separate electric circuit.
- The electrical building installation must be protected by a type C circuit breaker with a rating of at least 16 A.
- If an additional circuit breaker is used, it must be designed for a tripping current of at least 30 mA.
- The furnace requires the connection of a protective ground wire to the electric outlet for safe electrical operation.
- The distance between the electric outlet and the furnace must be selected so that the 2.5 m long power cord supplied with the furnace is sufficiently long (extension cords are not allowed!).
- The supply voltage must lie within the nominal voltage range of 200 VAC to 240 VAC. A separate building installation must be installed to meet this requirement in the USA and Japan. In the USA, the 240 V outlet must be designed for connecting a NEMA 6-15-type plug; in Japan, the 200 V outlet must be designed for connecting a NEMA L6 (L6-20J)-type plug.

Unit

Do not adjust the line voltage!

The unit automatically adjusts to the line voltage.

RS232 interface



A type RS232 serial interface (A) is located on the rear side of the unit. The use of this interface is restricted to the service engineer and is described in the service manual.

6 Operation

6.1 Controls and displays



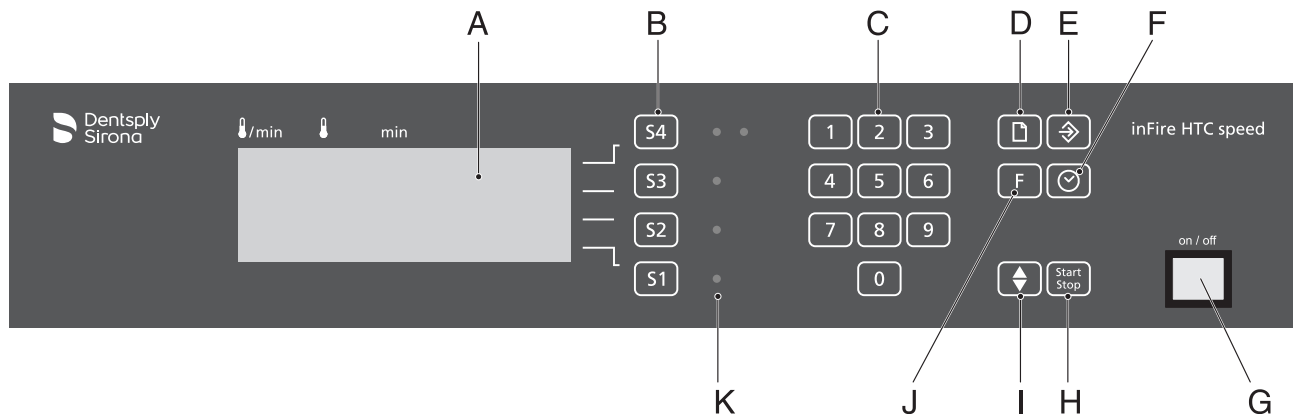





The controller is equipped with state-of-the-art microprocessor technology, which allows for processing a great variety of heating curves with utmost precision. Operation of the unit is menu-driven via a membrane keyboard and an LCD display. The following operating devices can be found on the controller:



Membrane keyboard

| | |
|---|----------------------|
| A | LCD display |
| B | Stage keys |
| C | Numeric keys |
| D | Memory key |
| E | Load program key |
| F | Casting time key |
| G | Main switch (ON/OFF) |
| H | START/STOP key |
| I | Lift key |
| J | Function key |
| K | Stage LEDs |

6.1.1 Key functions

| Symbol | Designation | Function |
|---|-------------------|---|
|  | Start/stop button | starts/stops the selected program |
|  | Load program key | loads the program from memory |
|  | Memory key | saves a program to memory |
|  | Casting time key | For setting the casting time; the switch-on time for the unit is calculated automatically |
|  | Lift key | For raising and lowering the door drive |
|  | Function key | for setting parameters |
|  | Numeric keys | for entering values |
|  | Stage keys | for enabling the entry cursor |

6.1.2 Description of the standby display

Screen layout for fixed programs

```

S I R O N A                2 4 ° C
i n C o r i s   T Z I / Z I   P 0 2
s p e e d                | M I   0 9 : 1 6
                          | M I   1 0 : 5 8
    
```



1st line: company name left-aligned, temperature right-aligned

2nd line: material name left-aligned, program in format "P00" right-aligned

3rd line: material name left-aligned, divider "|", current time (weekday, hh:mm) right-aligned

4th line: additional information left-aligned, divider "|", time of program end (weekday, hh:mm) right-aligned

Description of the columns on the left side with the freely programmed furnace programs

| Column | Designation | Description |
|---|---|---|
|  | Heating rate (heating and cooling down speed) | The heating and cooling down speed of the corresponding level is set up / displayed in this column. The heating and cooling down speed can range from 1 °C / min (33.8 °F / min) to 99 °C / min (210 °F / min). |
|  | Holding temperature | The temperature of the corresponding level is set / displayed in this column. |
|  | Holding time | The holding time of the corresponding step is set / displayed in this column. |

The laboratory furnace heats up and cools down in up to four temperature steps. It is possible to heat or cool down within the program run.

6.2 Switching on the unit

Switch-on

- ✓ The unit has been properly set up and connected to a power outlet.
- Turn on the main switch.
- ⚡ The main switch is illuminated and the LCD screen shows a status display for 3 seconds before the standby display is shown.

The furnace door opens automatically after a cooled furnace has been switched on.

Status display

```

Model No :      D 3 4 9 7
REF :          6 4 x x x x x
Serial No :     x x x x x
Hw :           SW : x x x x x x x x
    
```

| | |
|-------------|---|
| Line 1 (S4) | Model number (model no.: |
| Line 2 (S3) | Order number (REF:) |
| Line 3 (S2) | Serial number of electronics (serial no.: |
| Line 4 (S1) | Hardware version (HW:) and software version (SW:) |

6.3 Practical use

Explanation

The furnace can be used immediately after entering the required program.

NOTICE

Risk of breakage

The sintering trays to be used are fragile. They break with strong temperature fluctuations and under mechanical stress.

6.3.1 Initial startup

Burning-in sintering aids

Tip: We recommend subjecting all sintering aids (sintering tray, sintering shuttle) to a gradual burning-in cycle before sintering for the first time. To do this, load the furnace with the sintering aids and start the "inCoris ZI classic" program. This also applies to any new sintering aids supplied as repeat orders.

This procedure extends the service life of the sintering aids.

6.3.2 Sintering zirconium oxide

6.3.2.1 Preparing the sintering tray

NOTICE

Risk of damage to the furnace chamber

If incorrectly positioned, the sintering tray collides with the furnace chamber insulation.

- Ensure that the sintering tray is positioned centrally on the covering, before closing the furnace or starting the process.
- Place the sintering tray on the crucible tray and fill the tray with sintering pearls as required. Only use original Sirona sintering pearls for zirconium oxide. The correct fill level of the sintering trays varies depending on requirements. To prevent a delay, when positioning the restorations to be sintered, ensure that there is sufficient support and that the sintering pearls can move freely.

Take note of the following items when filling the sintering tray:

- Free movement of the sintering pearls
- Sufficient support for sagging restorations
- Positioning the restorations with the chewing surface facing downwards (in contact with the sintering pearls)
- Interdental areas should be free of sintering pearls

6.3.2.2 Preparing the furnace door

6.3.2.2.1 Furnace door with serial numbers < 5000

Furnace door components of the inFire HTC speed with serial numbers < 5000



Door insulation

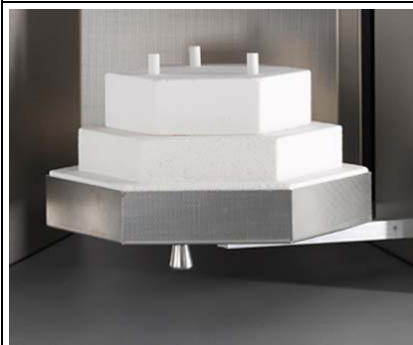

Door insulation with sintering pearls



Furnace door components of the inFire HTC speed with metal sintering option for serial numbers < 5000



Replacement door for metal sintering option



Design with sintering bells

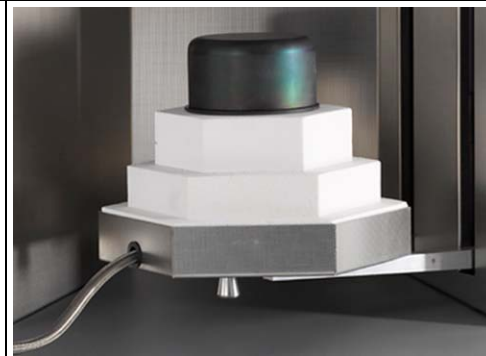

6.3.2.2.2 Furnace door with serial numbers ≥ 5000

Overview of individual components

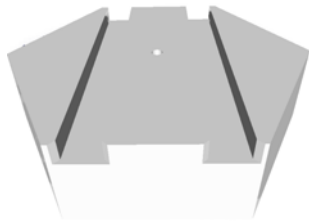

- Upper door insulation brick



- Split support disc



- Speed sintering tray



- Stacking disc



- Small centering tube

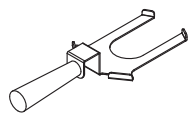

- Crucible fork for sintering tray

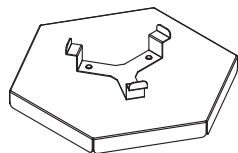

- Crucible tray

Constructing the furnace door

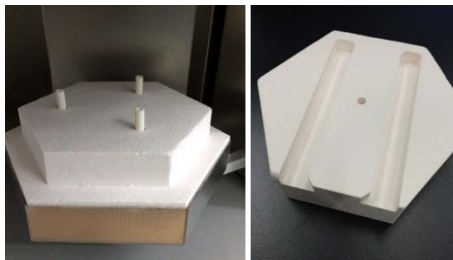
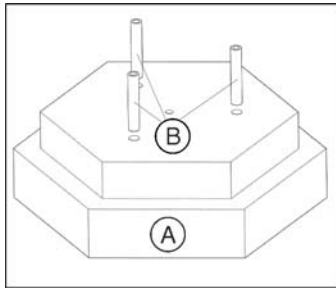

1. Fit the lower door insulation brick **A** using the small ceramic tube **B** and place it in the door panel.
2. Position the upper door insulation brick on the small ceramic tube on the lower door insulation brick. The upper door insulation brick guides make it possible to load and unload using the crucible fork.
3. Insert the small centering tube. In the case of a purely ceramic sintering furnace, the small centering tube serves to position the split support disc with the sintering tray.
4. Position the split support disc on the upper door insulation brick.

NOTICE

Risk of damage to the furnace chamber

If incorrectly positioned, the sintering tray collides with the furnace chamber insulation.

- Ensure that the sintering tray is positioned centrally on the covering, before closing the furnace or starting the process.

5. Position the sintering tray centrally on the split support disc.
6. After loading the furnace, the sintering process can start.
7. After the process, the tray can be removed using the crucible fork and allowed to cool on the crucible tray.



Using a second sintering tray

If you wish to stack, you require a stacking disc that is not split.

- ✓ The first sintering tray is constructed as described above.

NOTICE

Risk of damage to the furnace chamber

If incorrectly positioned, the sintering tray collides with the furnace chamber insulation.

- Ensure that the stacking disc and sintering tray are positioned centrally, before closing the furnace or starting the process.

1. Position the stacking disc centrally on the first sintering tray.
2. Position the second sintering tray centrally on the stacking disc and start the sintering process.

Removing the sintering tray with the crucible fork

The furnace should only be loaded and unloaded using the supplied crucible fork. Removal is via the guide grooves in the upper door insulation brick.

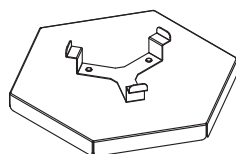

1. After sintering, slide the crucible fork to the end of the guide slots.
2. Lift the sintering tray with the split support disk and place it on a fireproof tray to cool down, e.g. on the crucible tray.



6.3.3 Program selection

1. Press the Load Program key.
 - ↳ The *LOAD PROGRAM* screen is displayed. The program name is displayed on the left side and the corresponding program number on the right side.
2. Enter the desired program number with the numeric keys or press the S4 key repeatedly until the desired program number appears.

```
S I R O N A           2 4 ° C
i n C o r i s   T Z I / Z I   P 0 2
s p e e d           |           Y E S
                    |           N O
```

6.3.4 Loading a program

- Press the "S2" key (=YES) to confirm the loading process.
 - ↳ The standby display is shown.
- To quit the menu immediately, press the "S1" key (=NO).

```
S I R O N A           2 4 ° C
i n C o r i s   T Z I / Z I   P 0 2
s p e e d           | T U 0 9 : 1 6
                    | T U 1 0 : 5 8
```

6.3.5 Starting the program

- Start the program with the Start/Stop key.
- ↳ The furnace door closes automatically. The furnace door automatically opens at the end of the program.

6.3.6 Lifting the sintering tray out of the furnace

- ✓ The furnace door is open.
1. Use the crucible fork to lift the sintering tray off of the rack.
 2. Place the sintering tray on the crucible rack with the crucible fork.

6.4 Operating modes

6.4.1 Super speed sintering (program starts at 1,580 °C / 2,876 °F, pre-heating required)

Drying procedure for inCoris ZI and inCoris TZI

The fast heating process involved in super speed sintering means that the restorations must be completely dry. Any residual moisture is very likely to cause damage (cracks or breakages) to a restoration. In general, two drying procedures are necessary when using inCoris TZI: one immediately after milling and one after coloring. To safely dry crowns made from colored inCoris TZI, the following drying procedure is recommended by way of example:

Example of the drying procedure:

10 minutes at 150 °C (±5 °C); it is imperative the drying temperature is maintained.

Recommendation for the unit: drying closets or other heating devices with precise temperature controls and a maximum temperature deviation of ± 5 °C.

For more detailed information, take note of the manufacturer's specifications for the material.

6.4.1.1 Performing super speed sintering

Auxiliary tools & equipment



- Super speed crucible fork
- Super speed crucible
- Superspeed fireproof tray
- Superspeed covering

Starting the super speed program

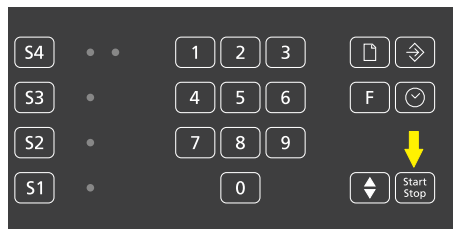

1. Start the super speed program by pressing the start/stop button.
 - ↳ The furnace closes automatically and initiates the pre-heating phase.

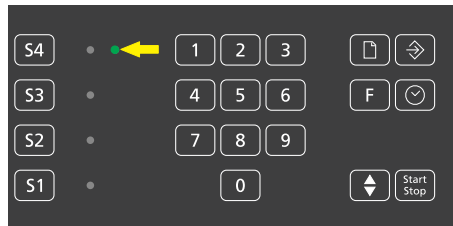

2. Take note of the display as the process continues. The display provides status information and help regarding the next step.
 - ↳ The heating time displayed corresponds to the time following program start.
 - ↳ When the desired temperature is reached, the green LED next to S4 lights up. The time window for starting the super speed process is 30 minutes.
 - ↳ After 30 minutes without a response by the operator, the furnace switches off automatically. In this case, the process must begin once again.
 - ↳ The 30 minutes are displayed as a countdown.

Loading the furnace

WARNING

Risk of burns if used incorrectly

The furnace opens at 1,580 °C (2,876 °F). There is only a risk of burns if the furnace is used incorrectly.

The internal company safety regulations for working on laboratory furnaces apply.

- Always stand when loading the furnace.
- Always wear long trousers and closed shoes.

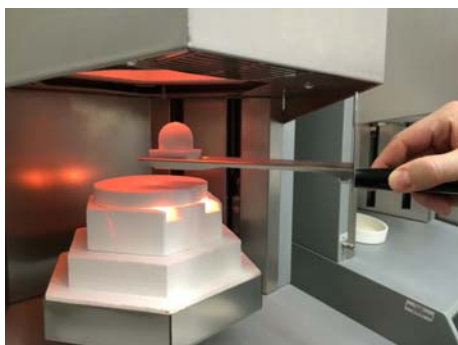
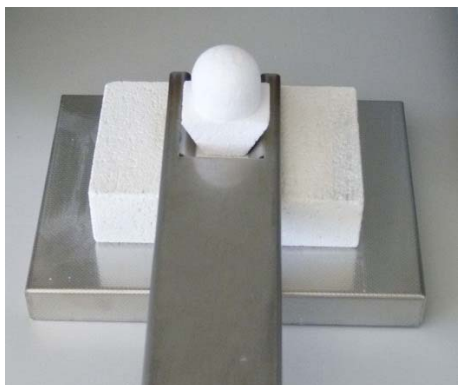
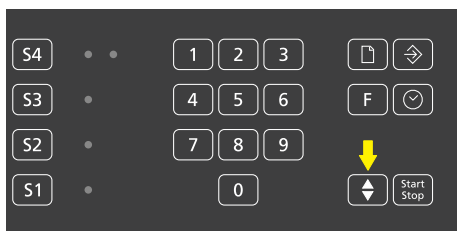

1. Start the super speed process by pressing the lift button.
 - ↳ The loading sequence lasts approx. 15 seconds from the end position of the furnace door. Loading must be completed within this time frame. The furnace closes automatically. A countdown displays the remaining loading time as a guide, before the furnace closes. If the start/stop button is actuated, the process is canceled and must be restarted.
2. Place the restoration with the occlusal surface (chewing surface) facing downward on the crucible.
3. Place the Superspeed covering over the restoration on the crucible.
4. With the help of the crucible fork, remove the crucible with the restoration and covering, so as to load the furnace.
5. Load the furnace.
 - ↳ The furnace closes automatically.

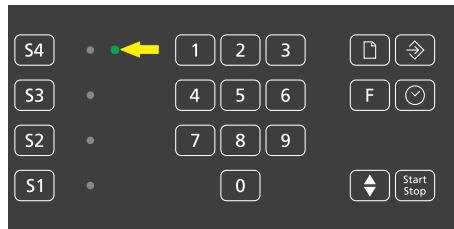

Sintering

After the holding time, the furnace opens at 1,580 °C (2,876 °F) and then cools down to 1,000 °C (1,832 °F) by itself. 1 minute before the door opens, the furnace displays a "countdown" of 60 seconds.

At 1,000 °C (1,832 °F), the display starts to flash. This is followed by an acoustic signal which repeats every 15 seconds. The signals are to indicate that the sinter may be removed.

Unloading the furnace at 1000°C



1. Lift the crucible from the furnace door using the crucible fork and place it on the fire-proof resting cube supplied with the device.
2. Press the start/stop button to close the furnace door. This helps retain residual heat to shorten the heating-up phase if the program is to be repeated.

↳ If you do not press the start/stop button after removing the crucible from the furnace door, the furnace door will close automatically after 5 minutes.

3. Wait 2 minutes.



4. Place the Superspeed covering on the fireproof tray using a pair of tweezers.



5. After 2 minutes retention time, place the object being sintered on the fireproof tray using a pair of tweezers.
6. Wait a further 2 minutes. Afterwards, the sinter is cooled down to the extent that you can touch it without risk of burns.

6.4.2 Speed sintering (program starts at room temperature, no pre-heating required)

This operating mode uses the speed sintering tray provided. Stacking the sintering trays is not permitted in this sintering program. As described in the "Practical use [→ 19]" section, the sintering tray is loaded with sintering beads and inserted into the furnace using the speed crucible fork. For more information, please refer to "Practical use [→ 19]".

6.4.3 Classic sintering (program starts at room temperature, no pre-heating required)

Classic sintering refers to the conventional long-term sintering process, which does not require the furnace to be pre-heated. Stacking a maximum of two sintering trays is permitted. The procedure is identical to speed sintering.

6.5 Non-precious metal (NPM) sintering (optional)

6.5.1 Safety instructions

6.5.1.1 Basic information



WARNING

All safety instructions contained in the operating instructions for the standard device apply as a basic rule.

The safety instructions from the following sources apply to the use of argon as a fuel:

- Safety data sheet from the manufacturer (e.g. Air Liquide)
- TRGS 510 (Technical Rule for Hazardous Substances) "Storage of hazardous substances in non-stationary containers", October 2010 edition

6.5.1.2 Use of argon in the inFire HTC speed with gas management module

With a factory-installed NPM function, the inFire HTC speed has an internal gas management module which requires an inlet pressure of 7-8 bar in order to provide the required volume flow of 1.1 l / min for NPM sintering.

The technical components are designed for a maximum inlet pressure of 8 bar.

The supply of argon is controlled via an electrically switchable valve.

When the program is started the furnace control activates the supply of argon and switches it off again when the program is terminated. The switching valve closes automatically in the event of a power outage.

DANGER

Observe the following when connecting argon at the furnace gas management module:

- The valve on the gas cylinder should be limited to a maximum outlet pressure of 8 bar in order to prevent excessive stress being placed on the installed components in the furnace.
- The outlet pressure of the cylinders must be set to a minimum of 7 bar and a maximum of 8 bar.
- Following installation, a check is required to ensure that the gas lines and connected sockets are secure and that there are no leaks so that no argon escapes uncontrollably.
- In the event of malfunction the volume of one argon cylinder is enough to flood an entire room. Therefore, adequate ventilation and air extraction is to be provided at the place of installation, otherwise the user is at risk of suffocation.
As the gas is heavier than air, appropriate ventilation in the floor area is recommended. Shafts and ducts must also be protected from gas infiltration.
- Do not store gas cylinders in the working area.
- Always check valves for tightness on full and empty cylinders when changing a cylinder.
- Secure cylinders from falling over.
- Maintenance: a regular tightness test is required.

6.5.2 Scope of supply

In addition to the standard functional scope, a furnace with NPM function also contains the following components:

- Furnace door with gas socket
- inCoris CC set, complete
- Zirconium oxide beads, Ø 1.25 mm (200 g) for inCoris CC

6.5.2.1 Retrofitting a gas management module

If you own a inFire HTC speed without an internal gas management module, you have the option of installing this later.

6.5.3 Enhanced program list

The inFire HTC speed with NPM function has an enhanced program list. This means that there are two additional programs provided when compared with the standard functionality.

| No. | Program name | Material | Mode |
|-----|-------------------|----------|------|
| 07 | Sirona inCoris CC | CoCrMo | NPM |
| 14 | Dentsply Crypton | CoCrMo | NPM |

6.5.4 Connecting the argon supply

DANGER

Danger of suffocation

Observe the national safety regulations when using argon in laboratories (for Germany: TRGS526, in particular 5.2.11 compressed gas cylinders and valves)

Applies for devices with serial numbers < 5000

When changing the furnace door from inCoris CC to ceramic, the argon supply must be **compulsorily** separated from the furnace's furnace door with gas socket, as otherwise uncontrolled argon gas will escape through the furnace door with gas socket during a ceramic sintering process.

Sintering non-precious metals (Dentsply Crypton, inCoris CC) requires an oxygen-reduced atmosphere. This is achieved using argon.

Argon is a noble gas in a compressed gas cylinder. Provide your cylinder with a manometer as well as a pressure regulator.

The purity of the argon should be at least 4.6 = 99.996 vol. %.

- Connect the argon pipe to the argon socket located on the rear side of the furnace.

The furnace requires a default argon pressure of 7-8 bar.

The flow of argon during an NPM sintering cycle is 1.1 l / min.

Determining the filling level of the compressed gas cylinder:

The filling level of the compressed gas cylinder can be ascertained from the manometer. A new argon compressed gas cylinder is filled with 200 bar. If the pressure displayed is only half of the pressure, i.e. 100 bar, then the cylinder is half empty.

Example:

a 50-liter compressed gas cylinder of argon with a filling pressure of 200 bar contains approx. 10,000 liters of argon.

The consumption per inCoris CC sintering cycle is approx. 270 liters at a flow rate of 1.1 l / min.

As a result approx. 35 inCoris CC sintering cycles are possible with a 50-liter compressed gas cylinder of argon.

6.5.5 Sintering pre-sintered NPMs (CoCr-base)

(not supplied depending on the standard equipment)

The set for the sintering of inCoris CC/CCB or "Crypton for inLab" consists of the following components:

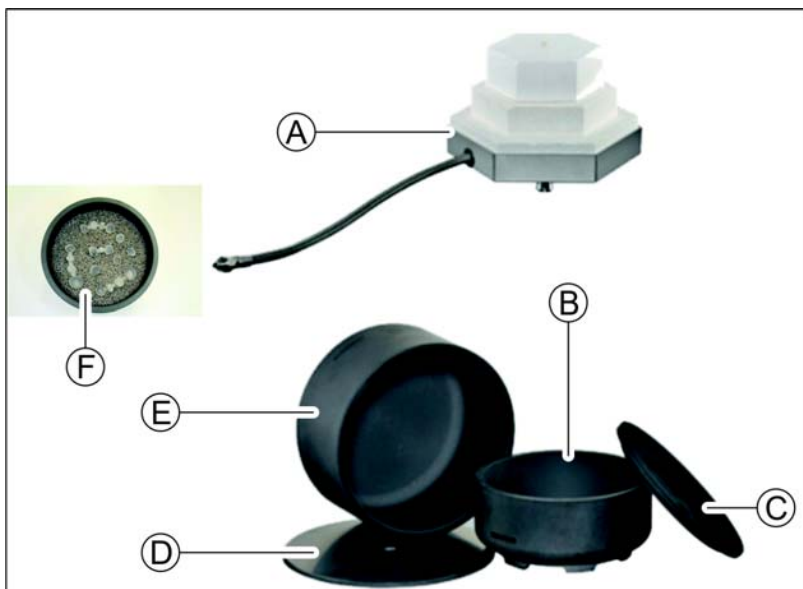

inCoris CCB set

| | | | |
|---|--|---|--|
| A | Furnace door with gas socket for inCoris CC/CCB | D | Base plate made of high-performance ceramics |
| B | Sintering tray made of high-performance ceramics | E | Sintering bell made of high-performance ceramics |
| C | Cover for sintering tray made of high-performance ceramics | F | Zirconium oxide beads Ø = 1.25 mm |



1. Fill the sintering tray with zirconium oxide beads. The filling level should be between 1.5 and 2 cm. In this process, only use the zirconium oxide beads for NPM sintering (REF 64 13 640).
2. Place the parts to be sintered in the sintering tray and position the restorations so that the crown margins protrude from the zirconium oxide beads by around 1 - 1.5 mm.

IMPORTANT

The zirconium oxide beads are white when new and change to a dark color during the NPM sintering cycle.

The base plate, sintering tray, cover, sintering bell, and zirconium oxide beads must undergo an NPM sintering cycle without sinter before the first NPM sintering cycle with sinter.



3. Place the sintering tray onto the center of the base plate.
4. Cover the sintering tray with the lid and sintering bell.
5. Load the heating program and start it with the *start/stop* button. When the sintering programs are changed from ceramic to metal sintering, a confirmation query appears on the display. Make sure that the right furnace door featuring a gas socket for metal sintering is installed. After checking to make sure that the right furnace door is installed, confirm the confirmation query and then start the program.
 - ↪ The lifting instrument moves upwards and seals the heating chamber.
 - ↪ The heating program runs fully automated.

WARNING

Risk of burning

The sintering tray is still hot after the sintering process. Its temperature is approx. 300 °C/572 °F.

- ✓ The temperature display shows the temperature of the furnace chamber and not that of the sintering bell.
- Wait until the furnace has cooled down completely.
- As an alternative, we recommend using commercial crucible and investment tongs.

6. Remove the sintering tray after the furnace has cooled down.
or
 - > Remove the sintering tray using commercial crucible and investment tongs.

Tip: From serial number 5000, the sintering bell can be removed using the supplied crucible fork.

6.5.6 Loading the furnace with the inCoris CC set, from serial number >5000

1. Place the base plate on the upper door insulation brick.

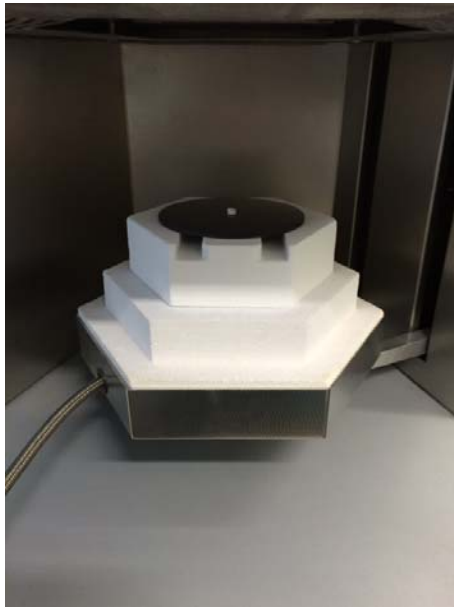

2. Position the sintering tray with the cover centrally on the base plate.



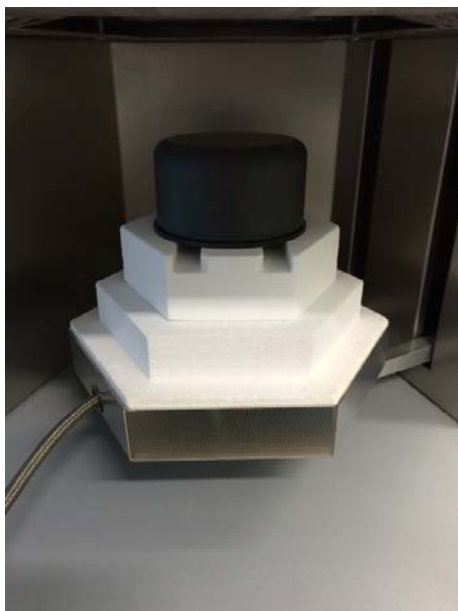

3. Cover the sintering tray with the sintering bell.

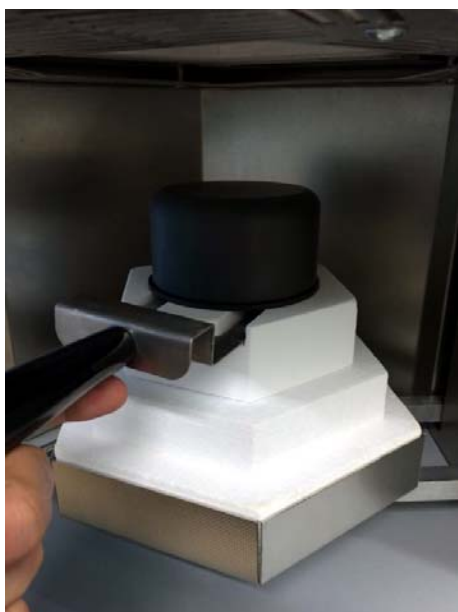

4. Following the completed sintering process, the inCoris CC sintering set can be removed from the furnace, using the crucible fork, and allowed to cool outside the furnace.

6.5.7 Replacing the furnace door (only for devices with serial numbers < 5000)

WARNING

Risk of burning

The furnace door may be hot.

- Check the temperature of the furnace on the display.
- Change furnace doors only in the cold state.

The furnace door must be changed when sintering oxide ceramics. The argon supply pipe for the furnace door with gas socket must also be removed.

Please proceed as follows to change the furnace door:

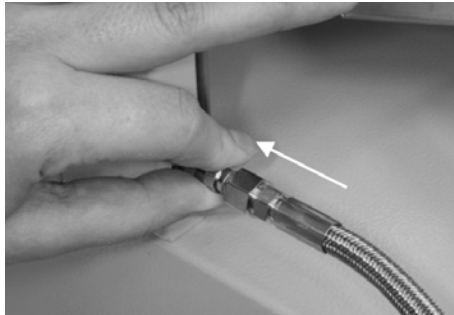

1. To disconnect the pipe socket for the argon supply, push the retainer ring for the argon socket towards the furnace enclosure.

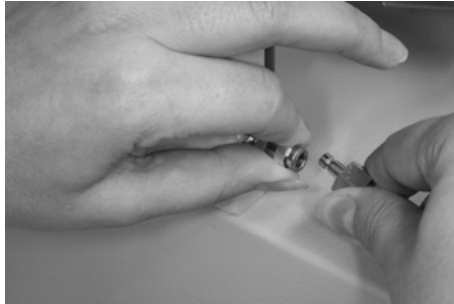

2. Pull the argon supply pipe of the furnace door with gas socket out of the socket.

DANGER

Danger of suffocation

If the pipe remains in the socket when sintering oxide ceramic materials, then argon escapes from the base plate of the furnace door with gas socket during the sintering process.

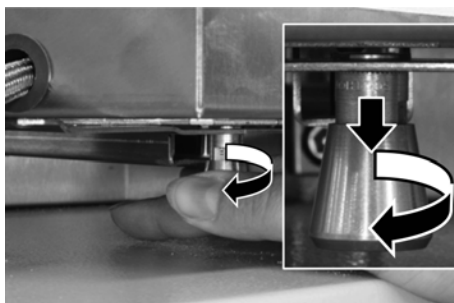

3. On the lower side of the furnace door there is a guide pin for locking the door with the furnace fastening clamp. To unlock the guide pin, pull this downward and then turn the pin in a counter-clockwise direction.
 - ↳ The pin is now unlocked and stopped.
4. Pull the furnace doors forward and out of the fastening clamp.

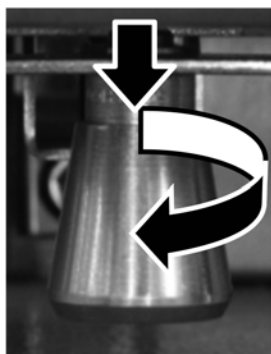
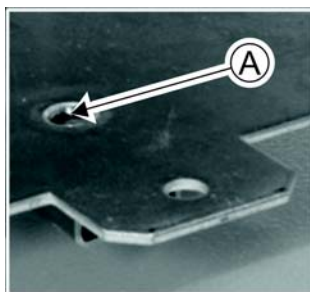

5. Ensure that the door guide pin is locked in place in the locating hole (A) provided for this purpose when inserting the furnace door for oxide ceramics.
6. Push the furnace door for oxide ceramics until the end stop in the furnace fastening clamp. Unlock the guide pin once more by pulling it and turning it counter-clockwise. Now pull the door forward carefully until the guide pin locks in place in the corresponding locating hole in the furnace fastening clamp.

NOTICE

Sinter program does not start

If the guide pin does not lock in place correctly in the slot of the furnace fastening clamp, then the door will not close properly once a sintering program is started. The sintering program will not start.

Explanation

6.6 Programs

With the inFire HTC speed sintering furnace, sintering is controlled via callable programs [→ 39].

- inFire HTC speed has fixed programs for sintering certain dental oxide ceramics.
- There are freely programmable programs for other dental oxide ceramics.
- The inFire HTC speed with integrated or retrofitted gas management system contains additional programs for the sintering of non-precious metals. This sintering process is conducted in a protective gas atmosphere with argon-flooding of the sintering bells that have been developed especially for this purpose (see section "Non-precious metal (NPM) sintering (optional) [→ 30]").

6.6.1 Plan for assigning furnace programs

The furnace control system contains 30 program channels:

- Programs 1 – 19 are fixed and cannot be seen by the user, i.e. heating rates, holding temperature, and holding time are not displayed and can only be changed by means of a software update from the manufacturer.
- Programs 20 – 26 (7 program channels) can be freely defined by the user.
- Programs 27 – 28 (2 program channels) can be freely defined and can also be assigned the special "pre-drying" function on the first program level (S1).
- Programs 29 – 30 (2 program channels) can be freely defined and can also be assigned the special "ventilation" function.

6.6.2 Fixed programs

Explanation

inFire HTC speed features fixed programs for various materials and manufacturers.

Overview

| Program No. | Designation |
|-------------|--|
| 01 | Sirona inCoris TZI/ZI super speed single |
| 02 | Sirona inCoris TZI/ZI speed |
| 03 | Sirona inCoris TZI/ZI speed + dry |
| 04 | Sirona inCoris TZI/ZI speed + air |
| 05 | Sirona inCoris TZI/ZI classic |
| 06 | Sirona inCoris AL classic |
| 07 | Sirona inCoris CC (optional) |
| | |
| 09 | VITA In-Ceram YZ speed |
| 10 | VITA In-Ceram YZ classic |
| 11 | VITA In-Ceram AL classic |
| 12 | Sirona service |
| | |
| 14 | Dentsply Crypton (optional) |
| | |
| | |
| 17 | IVOCLAR VIVADENT IPS e.max ZirCAD |
| | |
| | |

6.6.3 Select program number/load program

Select program number

```
S I R O N A           2 4 ° C
i n C o r i s   T Z I / Z I   P 0 2
s p e e d           |       Y E S
                    |       N O
```

Loading a program

1. Press the Load Program key.
 - ↳ The *LOAD PROGRAM* screen is displayed. The cursor is on the program number.
2. Enter the desired program number with the numeric keys or press the S4 key repeatedly until the desired program number appears.
 - Press the "S2" key (=YES) to confirm the loading process.
 - ↳ The standby display is shown.

To quit the menu immediately, press the "S1" key (=NO).

6.6.4 Starting the program

- Press the START/STOP key to start the process.
- ↳ The LCD display shows the stand-by screen. In the top line, the status *READY* changes to *RUN*. Blinking or illumination of the stage LCD indicates that a process is running. Passed program stages are no longer lit when they are completed.

You can pause the current program by pressing the START/STOP button again.

6.6.5 Starting a program with the Casting-Time function

```

                2 4 ° C
                P 0 2
| T H 1 8 : 1 9
FR 0 9 : 1 6 | FR 1 0 : 5 8
    
```

1. Select the desired program with the Load Program [→ 39] key.
2. Press the Casting-Time key.
- ↳ The LCD display shows the following screen:
 1. Press the S1 key to set the desired casting time of the program.
 2. Enter the day of the week with the numeric keys (MO=1, TUE =2, WED=3 ..., SUN=7)
 3. Enter the desired casting time (hh:mm) with the numeric keys.
 4. Press the START/STOP key.
- ↳ The LCD display now indicates the program start in line "S1." The casting-time function is now activated; there is no need to press any further key for confirmation.

To quit the program press the Casting-Time key again.

6.6.6 Freely programmable programs

Explanation

This section explains the freely programmable settings.

6.6.6.1 Entering program values

Programming step S1

1. Press the S1 key (S1 key for step S1).
 - ↳ The cursor will blink in the "Heating and cooling down speed" column.
2. Enter the heating velocity with the numeric keys. This can range from 1 °C /min (33.8 °F/min) to 30 °C /min (86 °F/min). If the heating velocity is 30 °C/min (86 °F/min), the furnace will heat up at maximum power.
3. The cursor now switches to the "holding temperature" column. Enter the four digits of the holding temperature in °C/°F (e.g. 1540/2804).

NOTICE

Entries with less than four digits

If the entry only consists of three digits (or less), the cursor must be moved to the "Holding time" column by pressing the corresponding S key.

4. Enter the holding time in minutes.

Programming steps S2 to S4

- Follow the same procedure as described for step S1 to program steps S2 to S4 (S2 key for step S2, etc.). In order to create a freely programmable fast sintering program, you must set a heating velocity of at least $> 30\text{ }^{\circ}\text{C}$ ($86\text{ }^{\circ}\text{F}/\text{min}$) for S3 (see "Entering the program values for fast sintering (speed sintering) [→ 42]").

NOTICE

Unrequired steps

If a step is not required, set all values of this step except the heating velocity to "0". It is not possible to set the heating and cooling-down speeds to "0", but this is of no importance for the program run.

While steps S1 through S3 may be set to 0, a temperature setting must be entered for step S4.

Step S4 always specifies the cooling parameters.

6.6.6.1.1 Programming example

| | Heating velocity | Temperature | Holding time |
|--------|-------------------------------|--------------------|--------------|
| | $^{\circ}\text{C}/\text{min}$ | $^{\circ}\text{C}$ | min |
| Step 4 | 12 | 300 | 0 |
| Step 3 | 12 | 1540 | 120 |
| Step 2 | 10 | 0 | 0 |
| Step 1 | 10 | 0 | 0 |

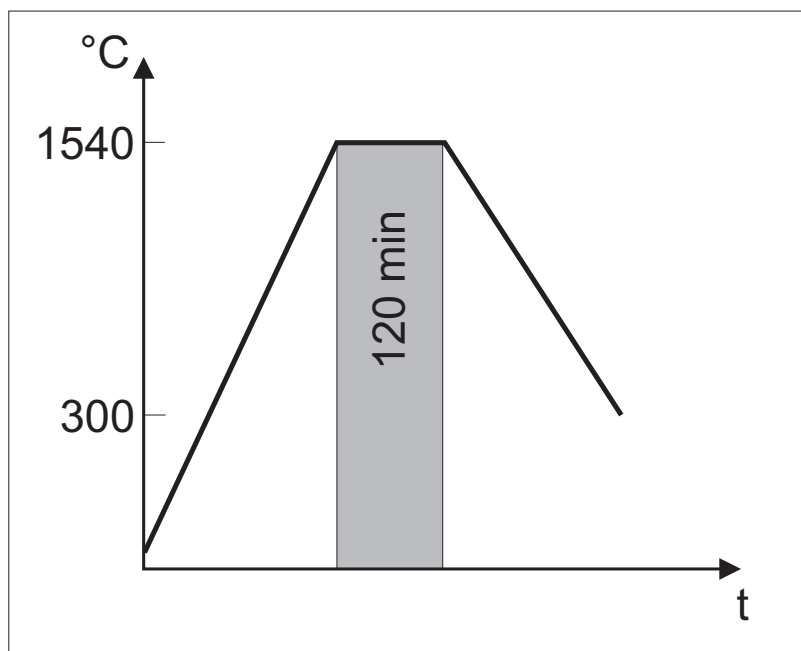

Graphical representation

This example describes the programming of program number 11 with the values of the table shown above.

1. Press the Load Program key.
2. Enter the program number *11*.

3. Press the S2 key (=YES) to confirm the loading procedure.

Programming step S3

1. Press the S3 key. The cursor will blink in the "Heating velocity" column of line S3.
2. Enter the value 12. The cursor will blink in the "Temperature" column.
3. Enter the value 1540. The cursor will blink in the "Holding time" column.
4. Enter the value 120.

Programming step S4

- Enter the values for step 4 as shown in the table.

NOTICE

Entries with less than four digits

If you did not enter the temperature as 0300 and used 300 instead, the cursor must be manually moved to the "Holding time" column by pressing the S1 key.

Steps S1 and S2

Since steps S1 and S2 are not needed in this example, you can leave their values at 0 with the exception of the heating velocity.

Storing the program

1. Press the Memory key.
 2. Press the S2 key (=YES).
- ↵ The program is now stored under the number 01.

6.6.6.2 Entering the program values for fast sintering (speed sintering)

For a fast or speed sintering program with S3, the cooling speed must be set to > 30 °C (86 °F/min); cooling is then performed via the door opening.

6.6.6.3 Programming example for fast sintering (speed sintering)

| | Heating speed (°C/min) | Temperature (°C) | Holding time (min) |
|----|---------------------------|---------------------|-----------------------|
| S4 | 70 | 750 | 0 |
| S3 | 70 | 1100 | 0 |
| S2 | 70 | 1540 | 30 |
| S1 | 12 | 0 | 0 |

6.6.6.4 Storing program values

Explanation

This section describes the procedure for storing changed program values of freely programmable settings (20-30).

Call method

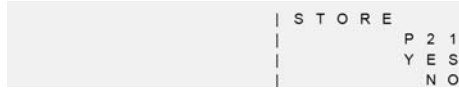

- ✓ Once program values have been entered with the keys S1 to S4, they can be saved.
- Press the Memory key.
- ↪ The LCD displays shows the following menu:

Entering a program title (optional)

Program titles can be entered on the left side of the display in four lines (the cursor flashes at the entry position).

Moving the cursor

Use the "S4" key to move the cursor one space to the right.

Numeric entry

Use the numeric keys (0-9) for entering numbers.

Text entry

Repeatedly pressing function key "F" displays the letters of the alphabet in succession.

Once the desired letter is reached, press the "S4" key to insert this letter in the display.

Deleting a character

You can delete characters by entering a blank space.

Once you have reached the blank space, press "S4" to insert it.

1. Press the "S4" key until you reach the character you want to delete.
2. Press function key "F" until the blank space appears (it comes after the letter "Z").
3. Press the "S4" key.

↪ The character has been deleted and the cursor has now moved one space to the right.

Save

- Press the "S2" key (=YES).

The program is stored under the number that was used for loading (e.g. 13).

To quit the menu immediately, press the "S1" key (=NO). The standby screen is shown.

7 Default settings

7.1 Display and acoustic signal

Explanation

Call method

Dialog box 1

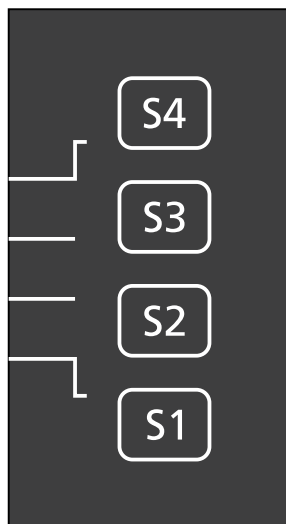

Dialog box 2

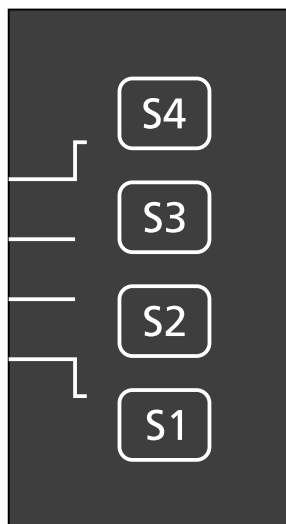

You can configure the display and acoustic signal via two dialog boxes.
Press function key "F".

Key assignment

- S4 key:
This key changes the language of the LCD screen.
- S3 key:
This key activates and deactivates the acoustic signal that sounds after the end of a program.
- S2 key:
This key sets the current time with the numeric keys (Monday = 1, Tuesday = 2... Sunday = 7).
The current time always has to be adjusted manually when clocks are changed for daylight saving time.
- S1 key: This key switches to Dialog 2.

Key assignment

- S4 key:
This key sets the temperature at which the furnace door should open (maximum 300 °C /572 °F).
- S3 key:
This key selects a 12-hour or 24-hour time display.
- S2 key:
This key is used to set the temperature scale to be used.
 - „°C“ = Celsius
 - „F“ = Fahrenheit
- S1 key:
This key quits the dialog.
The changes are saved in the memory.

7.2 Adjustment of the start time (casting time function)

Explanation

When calculating the start time (if the casting-time function is used), the furnace controller assumes an average voltage of 230 V.

The local voltage may significantly differ from this value according to local circumstances.

Accordingly, the calculation of the start and end time of the controller may be incorrect.

Substantial variations (of more than 30 minutes) may be adjusted by means of the correction program.

The correction program

The correction program compares the values in a test run and automatically corrects them.

This correction also remains intact even after the furnace is switched off.

NOTICE

Furnace empty?

No sintering trays may be located in the furnace during the correction program run.

Call

1. Load program 00.
 2. Start the program.
- ↳ The program automatically switches off following the correction measurement.

NOTICE

Long program run

This program takes about 3-4 hours to run.

- You can quit the program by pressing the START/STOP key if necessary.

8 Description of special functions

8.1 Sintering with ventilation (sintering with a small air gap)

This function means that the furnace door remains open with a small air gap at the first program level (S1) during the heat treatment process. This special function is activated on program channels 29 and 30, and on fixed program 4.

8.2 Sintering with pre-drying (sintering with a large air gap)

With this special function, the door remains open with a large air gap at the first program level (S1). This special function is activated on program channels 27 and 28, and on fixed program 3.

8.3 Pre-drying without sintering

Pre-drying without sintering can be set on the freely definable program channels 27 and 28. To do this, set only the variables at the first program level (S1). The other program levels have no values for the holding temperature and holding time. The input values for the holding temperature and holding time are both "0".

8.4 Sintering with defined cooling

The defined heating/cooling settings apply to all programs and phases when the lift is closed. The "speed" function applies to levels S3 and S4 for all programs, i.e.:

- When S4 temperature < S3 temperature (cooling) and S4 cooling rate > 30 °C/min (86 °F/min), the furnace will attempt to maintain the defined cooling rate by opening the lift at temperatures of 1100 °C (2012 °F) and above.
- For this purpose, the lift is opened gradually until the door is half open.
- At levels of up to 750°C (1382°F), the door opens completely.

9 Regular care

9.1 General care instructions

The high-temperature furnace does not require any special care. The casing may be cleaned with a mild detergent.

NOTICE

Damage to the heating unit

Avoid all contamination in the heating room to prevent damage to the heating unit.

NOTICE

Acidic coloring liquids

Coloring liquids may contain acids which can escape during the sintering process, significantly reducing the service life of the heating elements.

Recommendation: Use Sirona water-based coloring liquids:
- inCoris TZI coloring liquids.

9.2 Sirona service program

This sintering furnace is equipped with heating elements made from molybdenum-dicilicide. This material is coated with a silicon oxide protective layer when delivered. The protective layer on the heating elements prevents interactions with the restorations to be sintered.

The protective layer is normally formed by itself in the event of changing heating element programs. After each use of the furnace, the protective layer on the heating element can be worn out.

The service program warms the furnace to an ideal temperature, at which the protective layer on the heating elements is fully regenerated.

Using the service program (P12) once a month is recommended.

In the event of sole use of programs 2, 3, and 4, after 30 days, a note appears on the display requesting the use of the service program. The display message is hidden for 10s. A previously started program is then launched.

IMPORTANT

The service program requires approx. 6 h to regenerate the heating elements. This means that the furnace cannot be used during this time.

10 Maintenance

10.1 Changing fuses F1/F2

Replacement fuse

Required tools

Position

Changing a fuse

The order number for the replacement fuse is: 61 32 448 (10 items).

1x (flat) screwdriver

Fuses F1 and F2 are located at the bottom left on the rear side.

✓ The unit is switched off and its power plug is disconnected.



1. Unlock the cover of the fuse holder (**S**) with a screwdriver (press the cover slightly and turn it counterclockwise).
 2. Take the cover plus fuse out of the fuse holder.
 3. Pull the fuse out of the cover.
 4. Insert a replacement fuse in the cover.
 5. Place the cover with the replacement fuse back in the fuse holder.
 6. Lock the cover (**S**) again using a screwdriver (press the cover slightly and turn it clockwise).
- ↳ The fuse replacement process is now finished.

10.2 Replacing the battery (only for devices with serial numbers < 5000)

The battery has a limited service life. The battery must be replaced 24 months after commissioning (date of battery installation). After 24 months, the warning message "REPLACE BATTERY" will appear on the LCD screen.

NOTICE

Furnace overheating

In a worst-case scenario the battery may experience deep discharging, after which cooling cannot be guaranteed if the furnace overheats in the event of a power failure. If the furnace overheats it will be totally damaged.

NOTICE

Do not disconnect the device from the power supply

Even if the device is switched off on the main switch of the inFire HTC speed, the recharging of the battery is ensured by a direct connection to the charging electronics.

In order to guarantee the functioning of the emergency cooling, the device may not be disconnected from the power supply, as otherwise the recharging of the integrated battery will not be possible.

10.3 Furnace chamber insulation

The furnace chamber insulation consists of very high-quality fire-proof material. Crack formations in the furnace chamber insulation resulting from heat strain are to be expected due to the effects of high temperatures and sudden temperature changes. They will not affect the sintering result or the function and quality of the furnace.

11 Malfunctions

11.1 Error messages from electronic components

Error messages are displayed on the LCD screen. They are accompanied by an acoustic signal.

| Error message | Cause | Elimination |
|---|--|---|
| DEFECTIVE SENSOR | Thermocouple not functioning properly. | Call customer service. |
| Sensor + <-> - | Furnace interior considerably colder than room temperature or thermocouple not functioning properly. | Open door and wait until the heating chamber has reached room temperature Call customer service. |
| SECURITY TURN OFF(safety shutdown) | Furnace temperature exceeds 1650 °C (3002 °F) | Switch the furnace off and let it cool down. Call customer service. |
| SENSOR SHORT | Temperature sensor defect | Call customer service. |
| DEFECTIVE THYRISTOR | Defect in electronics | Call customer service. |
| REPLACING THE BATTERY (only for devices with serial numbers < 5000) | End of storage battery service life reached | Call customer service. |
| Long buzzer without LCD screen, furnace door does not close, program does not start | Door switch adjustment must be corrected | Call customer service. |

11.2 Miscellaneous errors and their causes

| Error | Cause | Elimination |
|---|---|---|
| Wrong time displayed. | Incorrect time in controller. | Correct time settings (see function key "F" [→ 44]) |
| Furnace does not heat up although autostart program is running. | Power was out for a long time during the autostart program. | Check the power connection. Make sure power connection is not switched with a timer. |
| Controller LED indicates heating, but the furnace does not heat. | Heating defective. | Call customer service. |
| Furnace "forgets" the stored programs. | Defective controller. | Call customer service. |
| Furnace "forgets" the time. | Defective controller. | Call customer service. |
| No display. Yellow/white (from serial numbers > 5000) pilot light of ON/OFF switch is on. The LEDs flash briefly after the unit is switched on. | Controller display is defective. | Call customer service. |
| No display. Yellow/white (from serial numbers > 5000) pilot light of ON/OFF switch is on. The LEDs do not flash briefly after the unit is switched on. | Protection fuse of the furnace is defective. | Switch the furnace off, wait 30 seconds and then switch it back on. If this produces no results: Replace fuses F1 and F2 [→ 48]. Call customer service. |
| No display. Yellow/white (from serial numbers > 5000) pilot light of ON/OFF switch is not on. | No line voltage | Check the fuses in the fuse box, check electrical connection. Call customer service. |
| Furnace triggers circuit breaker. | Unsuitable circuit breaker Defective electronics | Check the circuit breakers as specified. Call customer service. |
| Furnace triggers the circuit breaker in the fuse box. | FI is too sensitive or heating is defective | Check whether FI is ≥ 30 mA. Call customer service if necessary. |



12 Disposal

In accordance with Directive 2012/19/EU and national disposal regulations regarding old electrical and electronic devices, please be advised that such items must be disposed of in a special way within the European Union (EU). These regulations require the environmentally friendly recycling/disposal of old electrical and electronic devices. Such items must not be disposed of as domestic refuse. This has been expressed using the icon of the “crossed out trash can”.

Disposal procedure

We feel responsible for our products from the first idea to their disposal. For this reason, we give you an option to return our old electronic and electrical devices.

If you wish to dispose of your devices, please proceed as follows:

In Germany

To initiate return of the electrical device, please send a disposal request to enretec GmbH. You have the following options here:

- Use the “Returning an electrical device” button under the “eom” menu item on the enretec GmbH homepage (www.enretec.de).
- Alternatively, you can also contact enretec GmbH directly.

enretec GmbH
Kanalstraße 17
16727 Velten

Tel.: +49 3304 3919-500
E-mail: eom@enretec.de

In accordance with the national disposal regulations regarding old electrical and electronic devices (ElektroG), as the manufacturer, we assume the costs for disposing of the electrical and electronic devices in question. Disassembly, transport and packaging costs shall be borne by the owner/operator.

Prior to disassembly/disposal of the product, it must be fully prepared (cleaned/disinfected/sterilized).

If your unit is not permanently installed, it will be collected from the practice. If it is permanently installed, it will be picked up curbside at your address by appointment.

Other countries

For country-specific information on disposal, contact your local dental dealers.

Index

A

Acoustic signal, 44, 44

C

Casting time key, 18

Casting-time function, 40, 45

CE mark, 12

Celsius, 44

Controller, 17

D

Danger of overheating, 14

Daylight saving time, 44

DEFECTIVE SENSOR, 50

DEFECTIVE THYRISTOR, 50

Display, 44

Disposal of old electrical and electronic devices, 52

E

enretec GmbH, 52

F

Fahrenheit, 44

Fast sintering program, 42

Function key, 18

Fuse, 48

G

Gas management module, 31

H

Hardware version, 19

Heating and cooling down speed, 19

Holding temperature, 19

Holding time, 19

L

Language, 44

Lift key, 18

Load program key, 18

M

Memory key, 18

N

NPM sintering, 31

Numeric keys, 18, 26, 39

O

Operating devices, 17

Operation, 17

R

Replacement fuse, 48

REPLACING THE BATTERY, 50

Risk of breakage, 19

S

Safety instructions, 6

SECURITY TURN OFF, 50

SENSOR + <-> -, 50

SENSOR SHORT, 50

Sintering temperature, 13

Software version, 19

Speed sintering program, 42

Stage keys, 18

Start/stop button, 18

Status display, 19

Super speed process, 28

Super speed program, 27

T

- Temperature, 19
- Temperature scale, 44
- Temperature steps, 19
- The correction program, 45
- Time display, 44

V

- Ventilation slots, 14

We reserve the right to make any alterations which may be required due to technical improvements.

© Sirona Dental Systems GmbH
D 3497.201.01.19.02 09.2017

Sprache: englisch
Ä.-Nr.: 124 274

Printed in Germany

Sirona Dental Systems GmbH



Fabrikstraße 31
64625 Bensheim
Germany

www.dentsplysirona.com

Contact in the USA:

Sirona Dental, Inc.
4835 Sirona Drive
Charlotte, NC 28273
USA

Order No **61 30 459 D 3497**