

Nikon

AUTO REFRACT-KERATOMETER

Retinomax K-plus 2

Instructions

Thank you for purchasing this Nikon product.

This instruction manual is written for users of the Nikon "Auto Refract-keratometer Retinomax K-plus 2."

To ensure correct usage read this manual carefully before operating the instrument.

- It is prohibited to alter this manual in part or whole without expressed permission.
- The contents of this manual are subject to change without any notice.
- Although every effort has been made to ensure the accuracy of this manual, if you note any points that are unclear or incorrect, contact your nearest Nikon representative.
- Note that despite the above, Nikon does not bear any responsibility for any claim over loss due to the use of this instrument.







Caution Symbol in This Manual

Though Nikon products are designed to provide you utmost safety during use, incorrect usage or disregard of the instructions can cause personal injury or property damage. For your safety, read the instruction manual carefully and thoroughly before usage. Do not discard this manual but keep it near the product for easy reference.

Inside this instruction manual, safety instructions are indicated with the symbol shown below. Be sure to follow the instructions marked with this symbol for your safety.

| Symbol | Meaning |
|--|--|
|  CAUTION | Disregarding instructions marked with this symbol may lead to injury or property damage. |

Meaning of Symbol on the Instrument's Cover and Nameplate

| | | | |
|---|--|--|---------------------------------|
|  | AC power |  | OFF (cut off from power supply) |
|  | Fuse |  | ON (connected to power supply) |
|  | Caution: Please refer to instruction manual. |  | Input and Output |
|  | Type B equipment | | |

Please Read This First for Your Safety.



CAUTION 1 Intended Use

Only use the Auto Refract-keratometer Retinomax K-plus 2 for measuring the refractive power of the eye and curvature of the cornea.

Do not use this instrument for any other purpose.



CAUTION 2 Do Not Disassemble

Disassembling this instrument may lead to electric shock and/or malfunction of the instrument. Never disassemble this instrument.



CAUTION 3 During Measurement Operations

Do not strike the patient's face with the measuring unit when moving it laterally or toward the patient. Be particularly careful when using the forehead rest.

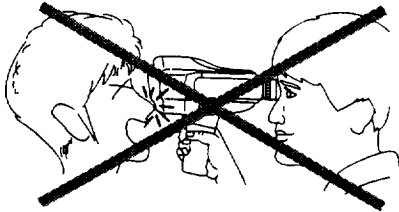

CAUTION 4 During Installation and Transportation

- Do not place the instrument in an unstable location such as on a wobbly table or tilted surface as this may cause the instrument to drop or fall over, resulting in possible injury.
- Hold the instrument by its grip. Do not hold it by the viewfinder or forehead rest.
- Place the station and the printer in a location with good ventilation. Do not obstruct the ventilation holes of the station or printer by placing a thick layer of cloth or paper underneath as this may lead to heat buildup inside during charging, resulting in possible fire or damage to equipment.
- Recommended operational conditions are an air pressure of 800 to 1060 hPa, a temperature of approximately 10°C to 35°C, and a relative humidity of 30 to 70%.
- Although the instrument is dust-proof, do not use it in a room where there is a lot of dust or dirt.
- The best place for installation is a dimly lit room. Do not face the patient side of the instrument toward a bright window or source of light.
- Although this instrument conforms to EMC standards (IEC60601-1-2:1993), it does emit a weak electromagnetic signal. If use of this instrument affects other equipment such as televisions or radios, separate it from the affected devices or change the direction it faces.
- Since this instrument is not water-proof in construction, never take it into locations where liquids such as rain or beverages may get inside.
- If condensation (dew) forms, do not use the instrument until the condensation disappears.



CAUTION 5 Other Notes on Handling

- Always use a specified power cord that is rated for the voltage used in your area and that has been approved under local safety standards.
Using the wrong power cord could result in damage or fire.
For 100 V – 120 V area : UL listed, detachable cord set, 3 conductor grounding type SVT, No. 18 AWG rated at 125 V, 7 A minimum.
For 230 V area : 3-pole power supply cord set, which must be approved according to EU/EN standards.
- Do not scratch, break or alter the power cord or overly bend, pull, twist or bundle it. Also, placing heavy objects on the power cord or subjecting it to heat may cause it to break, resulting in fire or electric shock. If the power cord becomes damaged, be sure to replace it with a new cord.
- If there is any dust on the power plug blades or the surface they connect to, pull out the power plug and remove the dust. The dust or grime can make the power plug and AC power outlet to be out of contact and may result in fire.
- Never short-circuit the contact points used for recharging the instrument or the printer's contact points for connecting the station. Doing so may blow the fuses of the instrument and the printer.
- Do not touch the contact points of connectors or battery charge contacts or allow metal to contact them. If contact points become dirty, turn off the power and wipe clean with a soft, dry cloth.
- This is a precision optical instrument containing many electronic components. Be sure to handle it carefully and do not subject it to strong physical shock.
- Do not drop or strike the instrument. Always use the supplied strap when handling the instrument. Do not swing the instrument by its strap.



CAUTION 6 Maintenance and Storage

- The specified transportation and storage environment is a temperature of -25°C to 45°C and relative humidity of 20 to 85%.
- When replacing a fuse, be sure to turn off the power switch and pull out the power cord. Be sure to use only a fuse of the specified rating. Electric shock or fire may occur if a fuse other than of the specified rating is used. Specified fuse:
For AC 100 V/120 V area : Time-lag fuse 125 V 2 A, ϕ 5.2 x 20 mm NAGASAWA ELECTRIC WORKS, LTD. Type "SB2" or NIPPON SEISEN Type "FBT2".
For AC 230 V area : Time-lag fuse 250 V 1 A, ϕ 5.2 x 20 mm NAGASAWA ELECTRIC WORKS, LTD. Type "ES3-1000" or HAMAI DENKYU Type "TDI-1A". (→ P.60)
- Measurement results are adversely affected if the measuring window glass surface becomes soiled with grease from the patient's nose, fingerprints or dust. Be sure to always keep the measurement window glass clean.
When cleaning the measurement window glass, take care not to scratch or break it. (→ P.61)

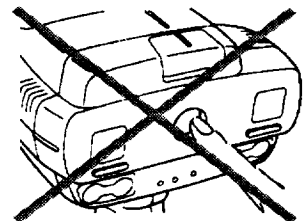



CAUTION 6 Maintenance and Storage

- When finished using the instrument, turn off the power switch of the station and cover it with its plastic cover.
- The internal battery

The instrument includes a primary lithium battery as the power source for the clock function and all setting functions stored in memory. If the battery goes out, the time and date printed on the measurement printout will be wrong. Also, settings will not be stored in memory and default settings will be restored every time the power is turned off. Contact your nearest Nikon representative when replacing batteries.

- Disposal

The Nickel-metal hydride battery and the Lithium battery are used for the instrument. When you abandon those batteries, check the rule or the local government and follow the directions.

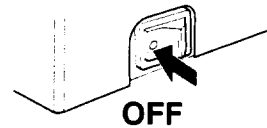

CAUTION 7 Battery Pack

- Use the specified DURACELL DR10 nickel-hydrogen battery pack supplied. Nikon does not guarantee operations if any other type of battery pack is used.
- Read the instruction manual provided with the battery pack before use.
- Do not disassemble the battery pack.
- Charge the battery pack only with the specified printer or station.
- Do not short-circuit the battery pack contact points or touch them with any metal such as a coin or paper clip as this may result in burn injury.
- Do not cover the measuring unit, printer, or station when charging or renewing the battery. Because charging generates heat, high temperature may result if the measuring unit, printer, or station is covered, possibly resulting in fire or reduced battery life due to increased load.
- Do not expose the battery pack to excessive heat or flames as this may cause it to leak, catch fire, or explode.
- Do not leave the battery pack in a place subject to strong sunlight or inside a car on a hot day with the windows closed.
- Do not drop the battery pack or subject it to strong impact.
- If the contact points of the battery pack become dirty, wipe them clean with a soft, dry cloth.
- If the equipment is not to be used for a week or more, remove the battery pack from the measuring unit and the printer.
- The battery pack is a disposable product. Although it can be used repeatedly through recharging, it cannot be used indefinitely.
Once the battery pack can no longer be used, purchase a new one from the retailer where you purchased the instrument.

■ Equipment Supplied ■

When you open the package, make sure that all the following items are included.

- Measuring unit (1)

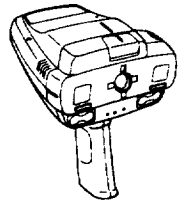

- Station (1)

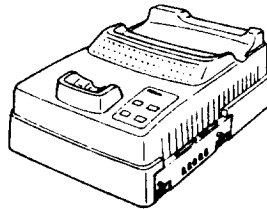

- Printer (1)

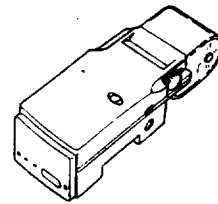

- Battery pack (1)



- Model eye (1)



- Printer paper rolls (5)

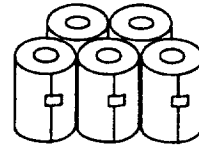

- Strap (1)



- Blower (1)



- Contact lens holder (1)

- Power cable set (1)

- Fuses (2) (125 V 2A, ø 5.2 x 20 mm)

- Instructions (1)

- Plastic cover (1)

The following products are available as options.

- AC adaptor

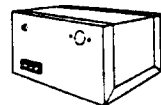

- DC cord

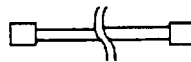

- Communication cable

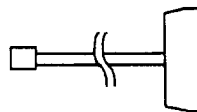

- Battery pack



Contents

| | |
|--|----|
| ■ Caution Symbol in This Manual | 1 |
| ■ Meaning of Symbol on the Instrument's Cover and Nameplate | 1 |
| ■ Please Read This First for Your Safety | 2 |
| ■ Equipment Supplied | 5 |
| 1 Nomenclature | 8 |
| 2 Preparation | 12 |
| 2-1 Attaching the Strap | 12 |
| 2-2 Setting Up the Instrument | 12 |
| 2-3 Measuring the Model Eye | 14 |
| 2-4 Checking Settings | 15 |
| 2-5 Charging the Battery | 16 |
| Notes on Charging the Battery Pack / 1. The Measuring Unit's Battery Pack / | |
| 2. The Battery Pack Inside the Printer / 3. Renewing the Battery / 4. Charging / | |
| 5. Charging the Spare Battery Pack (Option) | |
| 3 Measurement Method | 24 |
| ■ Measurement Screen | 24 |
| ■ Description of Test to Patient Before Measuring | 25 |
| ■ Measurement Modes and R-K Modes of the Unit | 26 |
| 3-1 Auto Measurement Mode | 27 |
| 3-2 Continuous Measurement Mode | 30 |
| 3-3 Quick Mode | 31 |
| 3-4 Cornea Periphery Measurement (PERI) | 32 |
| 3-5 Printing | 33 |
| 3-6 Using Multiple Printers | 35 |
| 3-7 For More Effective Measurements | 36 |
| 1. When the Left / Right Eye Identification is Difficult / | |
| 2. Measurements from 45°, 90° and 135° Positions / 3. Using the Forehead Rest / | |
| 4. When Measurements are Unstable (in refractometry) / 5. Notes / | |
| 6. Playing the Melody | |
| 3-8 Miscellaneous | 40 |
| 1. Automatic Fogging / 2. When Keratometry is Impossible / 3. IOL Patients / | |
| 4. Measuring a Hard Contact Lens Base Curve / | |
| 5. When Measurement Values Cannot be Obtained / | |
| 6. Representative Values for Refractometry and Keratometry / | |
| 7. Refractometry Confidence Values / 8. Auto Power Off / 9. Using a Password | |
| 4 Retro Mode | 43 |

| | | |
|----------|--|-----------|
| 5 | Making Various Settings (Setup) | 44 |
| ■ | User Settings | 44 |
| 5-1 | SETUP Screen | 45 |
| 5-2 | Hold Mode Setting Screen | 46 |
| 5-3 | Print Setup Screen | 47 |
| 5-4 | Time and Date Setting Screen | 48 |
| 5-5 | Patient No. Input Screen | 49 |
| 5-6 | Message Entry Screen | 50 |
| 5-7 | Output Setup Screen | 52 |
| 5-8 | Password Input Screen | 54 |
| 6 | Data Transmission to External Devices | 55 |
| 7 | Maintenance | 58 |
| 7-1 | Checking Measurement Accuracy | 58 |
| 7-2 | Replacing a Printer Paper Roll | 58 |
| 7-3 | Changing the Fuses in the Station | 60 |
| 7-4 | Cleaning the Forehead Rest | 61 |
| 7-5 | Cleaning the Measuring Window | 61 |
| 7-6 | Cleaning the Model Eye | 61 |
| 7-7 | Cleaning the External Case | 61 |
| 8 | Troubleshooting | 62 |
| 9 | Specifications | 64 |
| 9-1 | Measurement | 64 |
| 9-2 | Mesuring unit and Miscellaneous | 66 |

1

Nomenclature

System Configuration

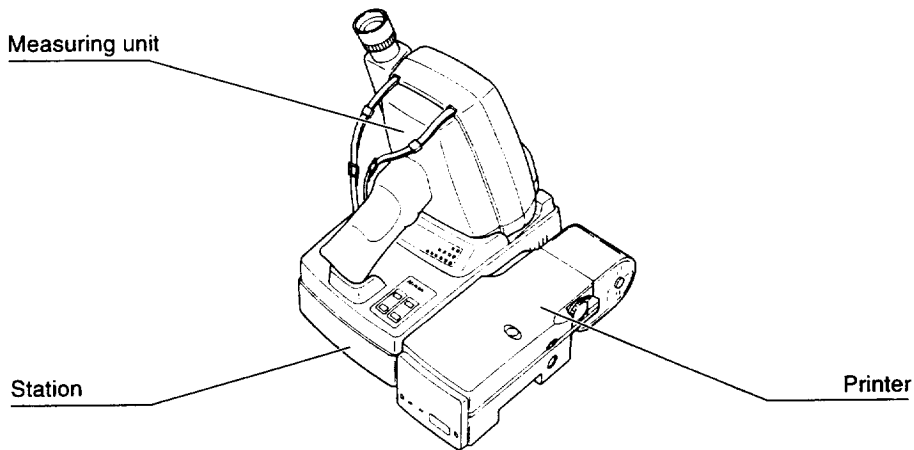

Measuring Unit (Patient side)

Horizontal eye position target line

Align with the patient's eye to determine the correct horizontal position. (→ P.27)

Forehead rest

Gently press against the patient's forehead to stabilize the measuring unit. (→ P.37)

Mire ring

Used as a target for alignment and to observe the degree of cornea distortion.

Vertical eye position target line

Align with the patient's eye to determine the correct height. (→ P.27)

Kerato-center measuring windows (four windows)

Used to measure the cornea center.

Measuring window

The patient looks at the target (→ P.25) through this window.

START switch

Starts and ends measurement. (→ P.27 to 32)

Measuring head

Contains the measuring mechanism.

Anterior segment illumination window and cornea peripheral measurement window

This window is used when illuminating the exterior of the eye and when performing peripheral keratometry.

Rubber pad

Shock absorbing rubber. This cushion is used when placing the measuring unit on the station.

Eye sensor

Automatically identifies the patient's right and left eyes using ultrasonic waves.

Battery charge contacts (three contacts)

Connect to the charging contacts of the station (→ P.10) to charge the battery pack.

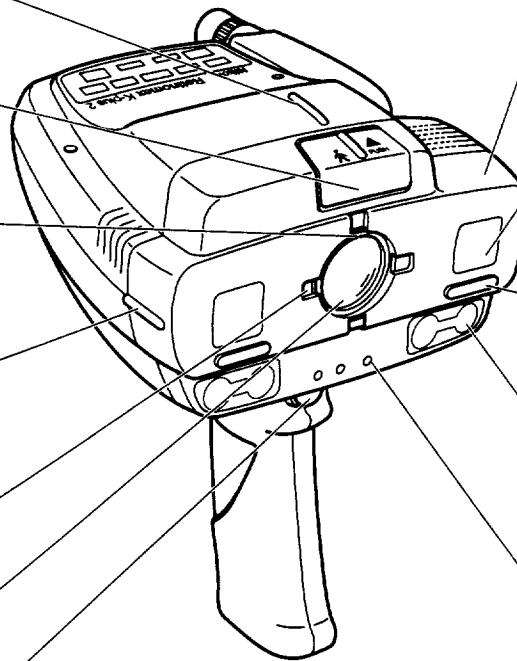

Measuring Unit (Operator side)

Power/communication connector

This connector is used to connect the DC cord (option) or direct communication cable (option). When using the DC cord and AC adaptor (option), it is possible to operate the measuring unit with the power from a wall outlet. (→ P.5)

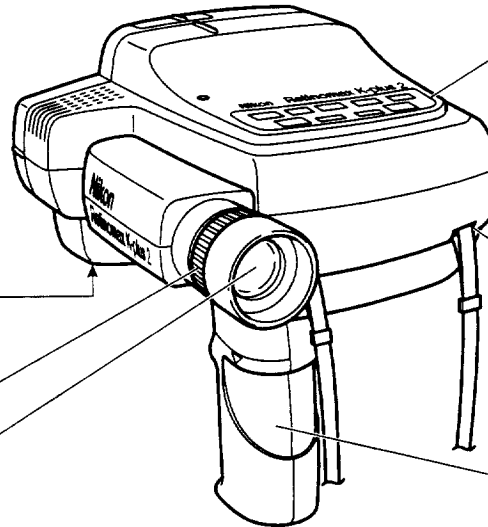

Switch panel

See "Measuring Unit Switch Panel" shown below.

Strap bracket

Diopter adjustment ring

View finder

Look at the patient's eye through this view finder to align the position and measure.

Grip

Hold this grip with your hand when handling the measuring unit.

Measuring Unit Switch Panel

PERI key

Used for measuring the cornea periphery.

RETRO key

Used when observing inside the pupil.

Target brightness key

Switches the brightness of the target between H (bright) and L (dark).

POWER switch

Turns the power of the measuring unit ON and OFF.

MODE key

Switches the mode between REF (Refractive), KER (Kerato), and REF/KER (Refractive/Kerato).

ANGLE key

Compensates the angle reading of the Ax (cylindrical axis) for the amount the measuring unit is turned (45°, 90°, or 135°).

QUICK key

Puts the measuring unit into QUICK mode. (→ P.31) Plays a melody when pressed for 0.5 or more seconds. (→ P.39)

PRINT key

Sends the measured data to the printer. (→ P.33)

R/L key

Switches between automatic and manual detection mode for identifying the left and right eyes. In manual mode, you must select the patient's right and left eyes manually. (→ P.36)

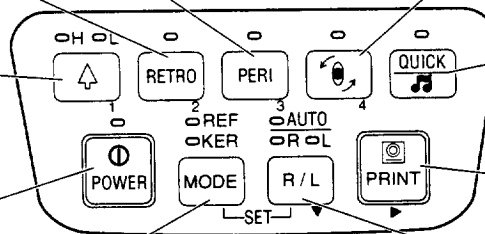

Station

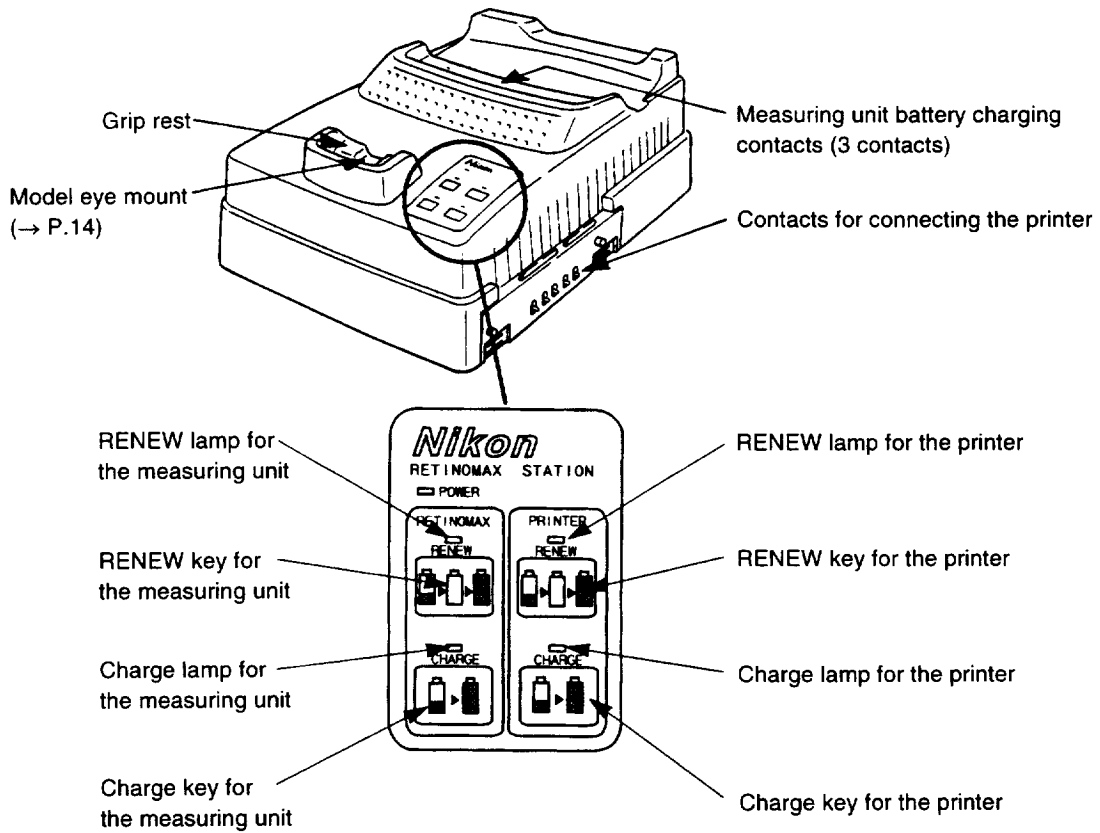

Station (Rear view)

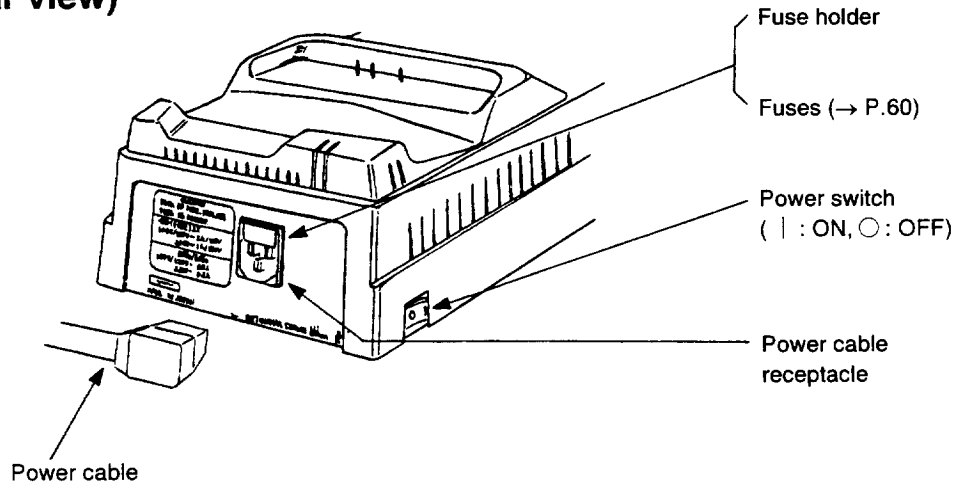

Printer

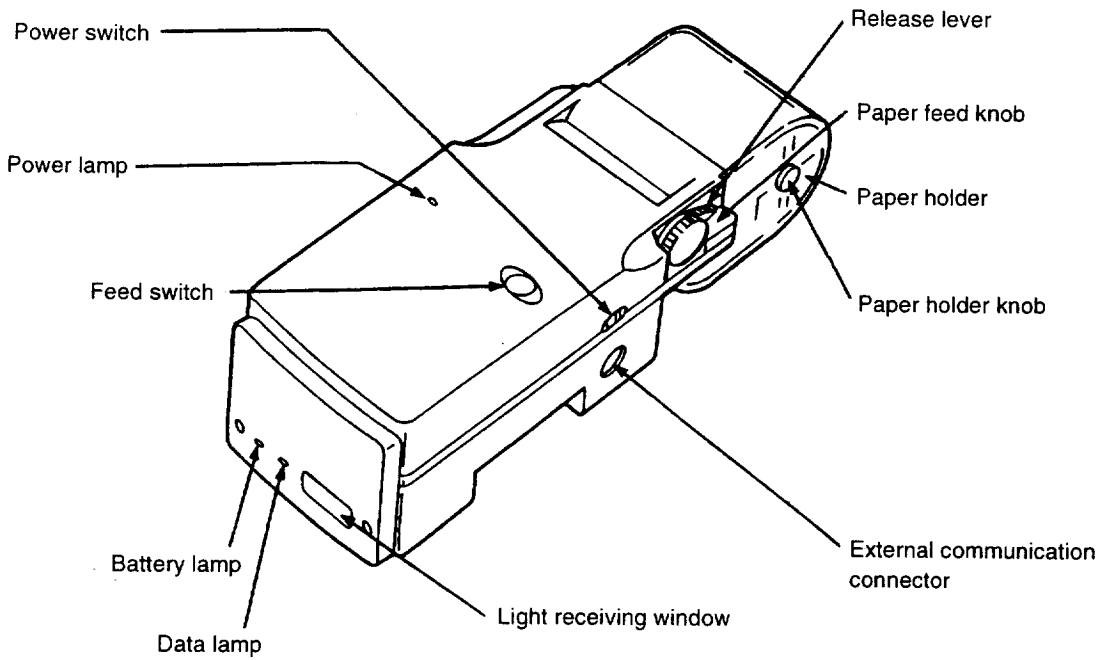

Printer (Bottom view)

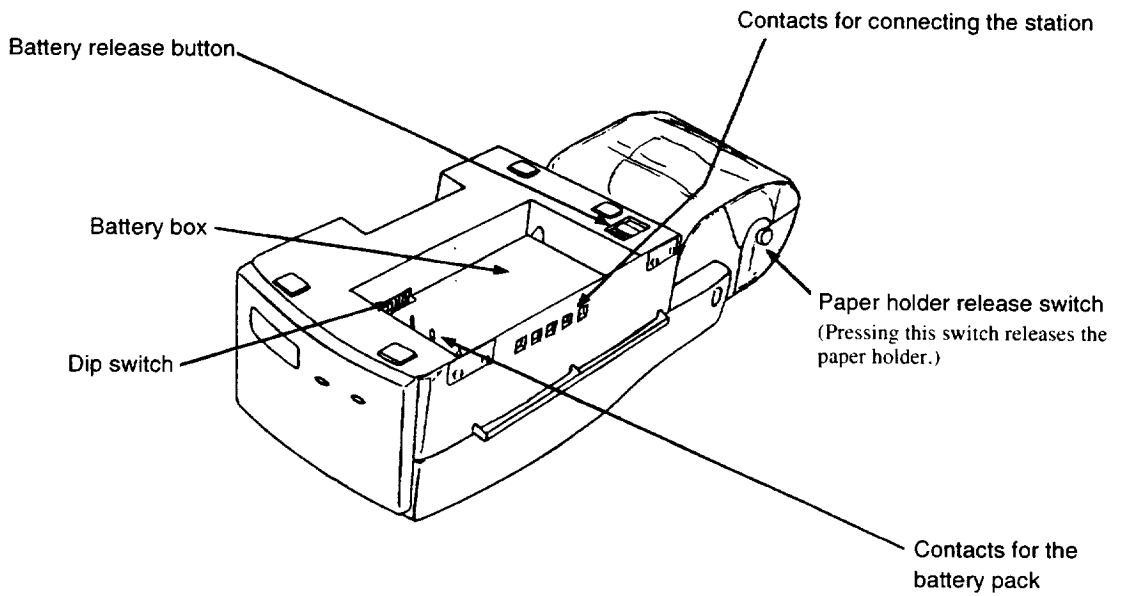

2

Preparation

2 - 1 Attaching the Strap

Attach the strap to the strap bracket on the measuring unit.



CAUTION

- Attach the strap securely to keep it from coming off.
- If the strap is scratched or damaged, replace it with a new one.

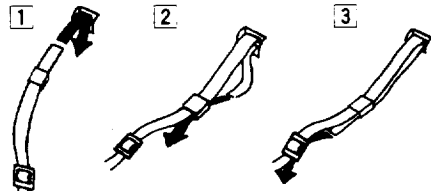

2 - 2 Setting Up the Instrument

- 1 Connect the power cable to the power cable receptacle located on the station.
- 2 Make sure that the station power switch is set to off (side marked ○), and plug the power cable into a wall outlet.
- 3 Turn the station power switch on (side marked |). The power lamp will turn on.
- 4 Install the battery pack into the measuring unit. (→ P.18)
- 5 Charge the battery by placing the measuring unit on the station. (It takes about 90 minutes to charge a fully discharged battery.) (→ P.19)
 - Always charge a battery pack before using it for the first time. When purchased, battery packs are not charged.
 - When a battery pack is used for the first time or for the first time in over a month, the battery will need to be fully charged 2 or 3 times before its performance returns to the original level.



When you charge the battery for the first time or charge the battery after it has been unused for a month or more, the charge lamp goes off after about 10 to 15 minutes to show that the battery has been fully charged. This occurs **when you charge the battery pack for the first time**. If this happens, install the battery pack, press the CHARGE key for the measuring unit battery pack or printer battery pack and begin charging again. (→ P.23) If the charge lamp does not go on when you press the CHARGE key, press it again. Or renew the battery since the battery renewal enables you to fully charge the battery easily. (→ P.22)

- 6 Install the printer paper roll into the printer. (→ P.58)
- 7 Connect the printer to the station.

Aligning the seal on the top panel of the printer with the switch panel of the station as shown in the figure at the right allows this connection to be made more easily.

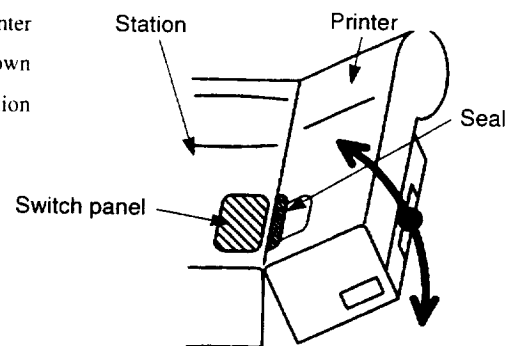

- 8 Turn on the station and printer power switches.
Press the FEED switch and feed the paper a suitable amount.
 - The printer can also be operated using the battery pack. (→ P.20)
- 9 Remove the measuring unit from the station and turn the measuring unit on.

2 - 3 Measuring the Model Eye

Make sure that the model eye and measuring window are clean. If either are dirty, carefully clean them according to the instructions given in "7-5 Cleaning the Measuring Window" and "7-6 Cleaning the Model Eye". (→ P.61)

- 1 Place the model eye on the model eye mount located on the station.

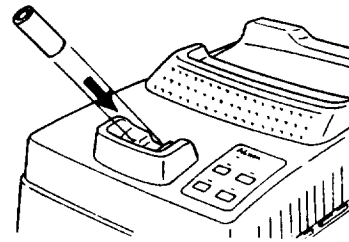

- 2 Measure the model eye. For details, see "3. Measurement Method" (→ P.24 to 42).



 Do not point the measuring windows on the measuring unit toward bright light during measurement. Doing so may adversely affect measurement accuracy or make measurement impossible.

- 3 The values measured for the model eye must be within the following ranges when compared with the values (SPH, CYL, R) shown in the label attached to the model eye.

| | |
|---------------|---------------|
| SPH : ±0.25D | CYL : ±0.25D |
| R1 : ±0.02 mm | R2 : ±0.02 mm |
| T : ±0.05 mm | N : ±0.05 mm |
| S : ±0.05 mm | I : ±0.05 mm |

If any values are not within the above ranges, see "3. Measurement Method" (→ P.24 to 42) and check that the measurement method used is correct and then measure again.

Next, see "7-5 Cleaning the Measuring Window" and "7-6 Cleaning the Model Eye" under "7. Maintenance" (→ P.61) and check whether it is dirty. If it is dirty clean it. If values still are not within the above ranges, contact your nearest Nikon representative.

2 - 4 Checking Settings

The initial settings are shown below.

■ Environment settings (→ P.45 for the SETUP screen)

| | |
|-----------------------------|----------------------------|
| Measurement mode (READING) | AUTO |
| Astigmatism mode (CYL MODE) | MINUS (-) |
| Cornea vertex distance (VD) | 120 V: 13.75, 230 V: 12.00 |
| BUZZER | ON |

■ Initialization values (→ P.46 for hold mode setting screen)

| | |
|-------------|---|
| QUICK | NORMAL (Cancels QUICK mode when initializing) |
| RL SENSE | AUTO (Sets AUTO mode for right-left eye identification at initialization) |
| R/K MODE | R/K (Sets REF/KER mode at initialization) |
| AX ROTATION | NORMAL (Cancels Ax compensation mode at initialization) |

■ Print settings (→ P.47 for the print setup screen)

| | |
|-----------|--|
| REF PRINT | ALL (Prints out all the data measured in REF mode) |
| KER PRINT | REP (Prints out only the representative values measured in KER mode) |
| MSG PRINT | OFF (Does not print out) |
| EYE PRINT | OFF (Does not print out) |

■ Clock settings (→ P.48 for the time setting screen)

| | |
|-------------------------------|--|
| Date print format (DATE-FORM) | 120 V: MDY, 230 V: DMY (Displayed in the sequence year-month-day) |
| Time print format (TIME-FORM) | 120 V: AM/PM, 230 V: 24H (Displayed in 24-hour time format) |

■ Output settings (→ P.52 for Output setup screen)

| | |
|--------------|--|
| PRT UNIT NO. | 1 (Identification number of the measuring unit) |
| PRT RS OUT | OFF (Sends no data from the printer's external communication connector) |
| PRT RS PROT | NK1200 (Sets the transmission speed from the printer's communication connector to 1200 bps in NK format) |
| RS232C OUT | OFF (Sends no data from the measuring unit's / AC adaptor's communication connector) |
| RS232C PROT | NK1200 (Sets the transmission speed from the measuring unit's / AC adaptor's communication connector to 1200 bps in NK format) |

2 - 5 Charging the Battery

Be absolutely sure to read these precautions before charging the battery for the first time.

Notes on Charging the Battery Pack

When using the battery for the first time

Always charge the battery before using it.

A newly purchased battery pack is not charged.

Be sure to read the instructions included with the battery pack.

Notes on charging the battery pack

- When charging or renewing the battery pack, do not cover the measuring unit, printer and/or station with the cover. Doing so may result in fire as heat is generated during charging and builds up in the measuring unit, printer and/or station. This also puts a load on the battery pack and may shorten its life.
- When you charge the battery for the first time or charge the battery after it has been unused for a month or more:

The charge lamp goes off after about 10 to 15 minutes to show that the battery has been fully charged. This occurs **when you charge the battery pack for the first time**. If this happens, install the battery pack, press the CHARGE key for the measuring unit battery pack or printer battery pack and begin charging again. (→ P.23) If the charge lamp does not go on when you press the CHARGE key, press it again. Or renew the battery since the battery renewal enables you to fully charge the battery easily. (→ P.22)

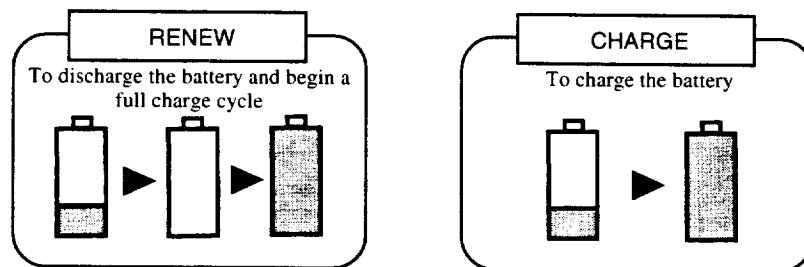

- The battery pack and measuring unit grip become warm immediately after the battery pack is charged or renewed. This is not abnormal.
- Battery life will be shortened if the battery pack is manually charged after the battery pack has been completely charged without using the unit. Avoid unnecessary manual charging.

When performing manual charging, be sure to charge the battery only after using the measuring unit or printer for 20 to 30 minutes or more or after allowing 3 hours to elapse since the previous charging.

- Nothing will happen when the CHARGE key or RENEW key is pressed within about two hours after charging or renewing the battery pack if the measuring unit or printer has not been removed from the station. This is a protective feature to prevent excessive charging of the battery pack and is normal.
- If the charge lamp or renew lamp flashes during charging or renewal, there may be a charging error. Check for this using the following procedure.

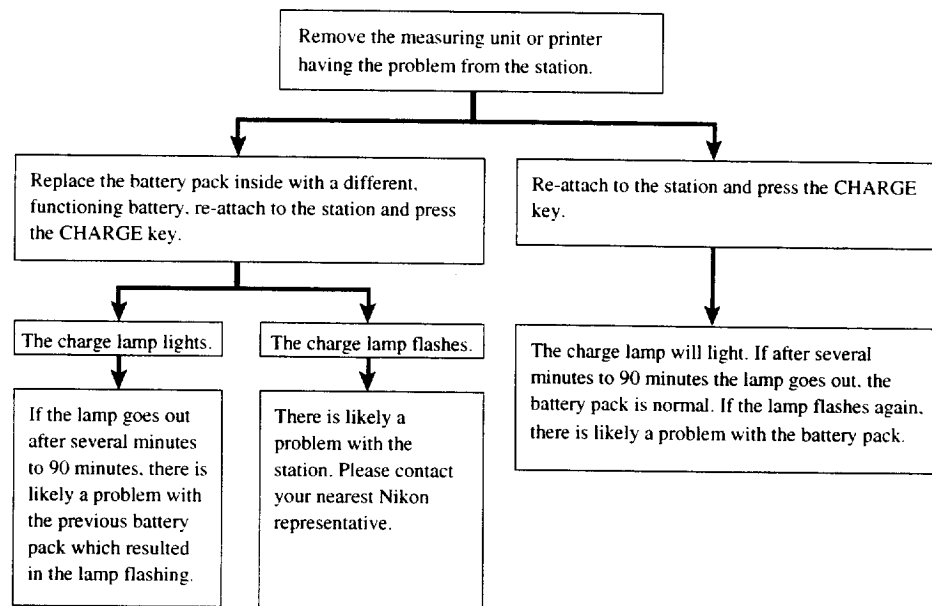

- It is possible to remove the measuring unit or printer from the station and use it even before charging is complete.

■ Notes on the contacts

- If the contacts become dirty, the battery cannot be charged properly due to the faulty electrical contact.
- Be careful not to touch the station contacts (pins), measuring unit contacts (plates), or printer contacts (pins and plates).
- Also, be careful not to touch the battery pack contacts (plates).
- If you touch a contact or it becomes dirty, wipe it with a dry cloth.

1. The Measuring Unit's Battery Pack

Replacing the battery pack

- 1 Press the top of the battery pack cover located on the grip in direction ① with your finger and slide in direction ②.
- 2 Exchange the battery pack inside for a new one.
- 3 Close the battery pack cover.

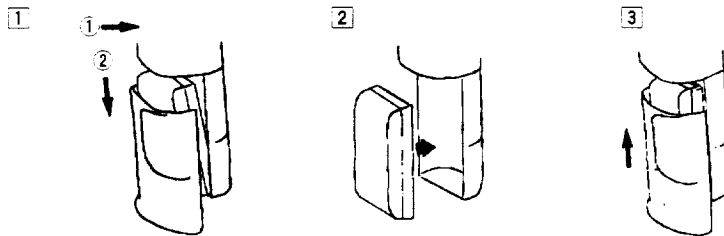

- ⓘ When installing a battery pack, align the green seal on the battery pack as shown in the figure in the battery box.

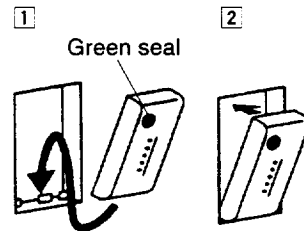

Automatic charging

Follow the procedure given below when automatically charging the battery pack inside the measuring unit.

- 1 Turn on the station power switch (to the side marked \uparrow).
- 2 Place the measuring unit on the station.

 Make sure the measuring unit is securely housed in the station. If it is not securely housed, there may not be proper contact between the contacts. Also, be sure to retract the forehead rest as the measuring unit cannot be securely housed in the station when it is extended.
Check that a battery pack is installed in the measuring unit.

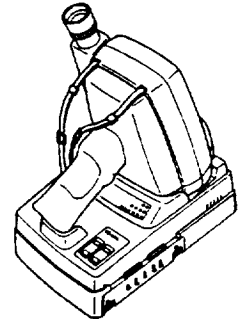

- 3 The battery pack will be charged automatically when the battery pack's charge becomes low. The charge lamp for the measuring unit on the station will light several seconds after charging begins.
Note that if the charge in the battery pack is at about 50% capacity or more, the lamp will not light and charging will not be performed. This is a protective feature to prevent shortening of the battery pack's life. If the remaining charge is about 50% or less, the battery will be charged to maximum capacity. (Charging takes approximately 90 minutes.)
- 4 The charge lamp for the measuring unit on the station will go out when charging is complete.

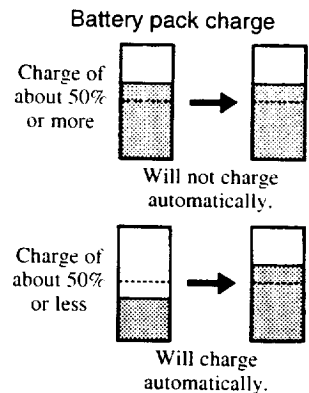

-  This 50% value is merely given as a reference figure and fluctuates depending on how the battery is used and how many times it has been charged.
- The battery pack is not always kept fully charged. Press the CHARGE key or the RENEW key if you want to fully charge the battery pack. (See "Renewing the battery" on page 22 and "Charging" on page 23)

2. The Battery Pack Inside the Printer

Replacing the battery pack

It is possible to operate the printer on battery power by loading an optional battery pack in the printer's battery box (same model as that used with the measuring unit) and charging it.

The battery pack is charged while inside the printer's battery box.

 A battery pack is not included with the printer. Please purchase an optional battery pack if you wish to operate the printer on battery power.

- 1 Push upward the battery pack release switch.

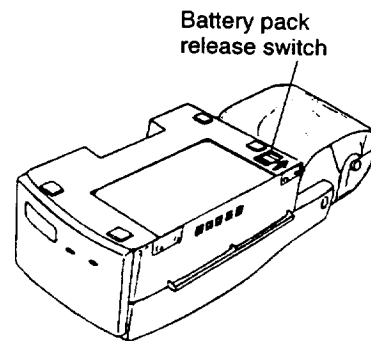

- 2 Turn the printer sideways. This will cause the battery pack to raise up.

- 3 Remove the battery pack and insert another battery pack. An illustration showing how to install the battery is located inside the battery box. As shown in the figure, align the green seal on the battery pack and insert in direction ① and push in direction ② until it catches in place.

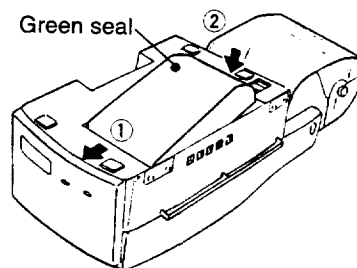

-  Check that the orientation of the battery pack is such that the three contacts are aligned as shown in the figure.

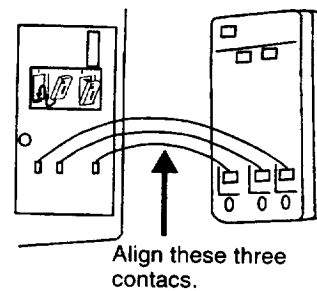

Automatic charging

Follow the procedure given below when automatically charging the battery pack inside the printer.

- 1 Turn on the station power switch (to the side marked |).
- 2 Connect the printer to the station as shown in the figure.

Aligning the seal on the top panel of the printer with the switch panel of the station as shown in the figure at the right allows this connection to be made more easily.

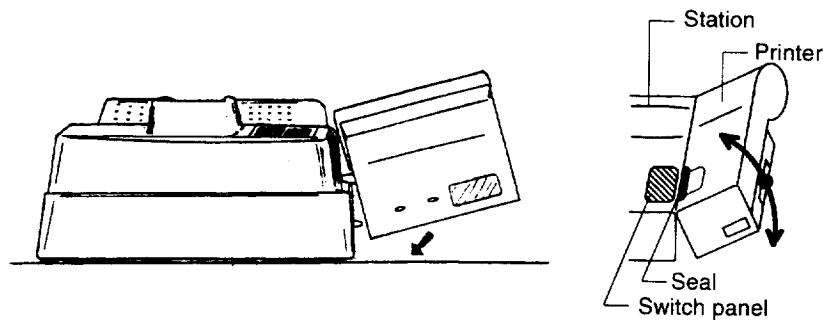

- 3 The battery pack in the printer will be charged automatically.

The charge lamp for the printer on the station will light several seconds after charging begins.

Note that if the charge in the battery pack is at about 50% capacity or more, the lamp will not light and charging will not be performed. This is a protective feature to prevent shortening of the battery pack's life. If the remaining charge is about 50% or less, the battery will be charged to maximum capacity. (Charging takes approximately 90 minutes.)

- 4 The charge lamp for the printer on the station will go out when charging is complete.

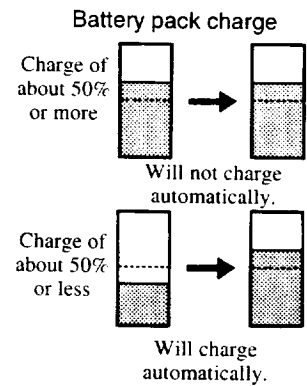

- This 50% value is merely given as a reference figure and fluctuates depending on how the battery is used and how many times it has been charged.
- Place the station and printer on a flat, level surface. Placing them in an unstable location may interfere with a good connection between the station and the printer.
- The battery pack is not always kept fully charged. Press the CHARGE key or the RENEW key if you want to fully charge the battery pack. (See "Renewing the battery" on page 22 and "Charging" on page 23.)

3. Renewing the Battery

The operational time for the battery will become shorter even given a full charge after the battery has been discharged and charged repeatedly. (This is called a "memory effect".)

It is possible to restore the operational time of a battery by first fully discharging it and then fully charging it. This is called "renewing" a battery.

You can renew a battery pack as follows.

- 1 Press the RENEW key for 1 second or more.

Press the RENEW key for the measuring unit when renewing the measuring unit's battery pack and the RENEW key for the printer when renewing the printer's battery pack.

The RENEW lamp will light.



- 2 The battery will automatically discharge and then charge.

Although the time required to renew a battery pack depends on the amount of charge remaining when discharging begins, the maximum time required is about 4 hours and 30 minutes.

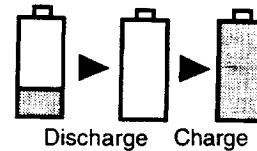

- 3 The RENEW lamp will go out once the battery pack is fully charged.

Pressing the CHARGE key during operations will forcibly switch to recharging.

If you wish to stop renewal before the renewal is complete, you may either again press the RENEW key for 1 or more seconds or remove the measuring unit or printer being renewed from the station.

The batteries operational life is over if its performance is not restored by renewal. If this happens, purchase a new battery pack from the dealer where you purchased the instrument.

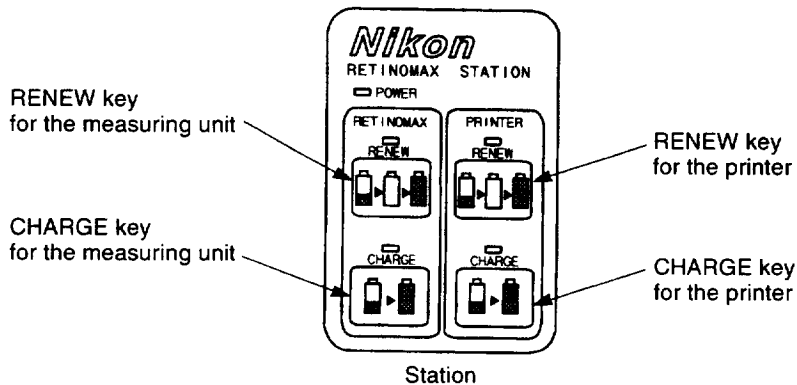

4. Charging

Follow the procedure given below when forcibly recharging a battery pack without regard to its current charge.

- 1 Press the CHARGE key.

The charge lamp will light and charging will begin.

When charging the battery in the measuring unit, press the CHARGE key for the measuring unit. When charging the battery in the printer, press the CHARGE key for the printer.

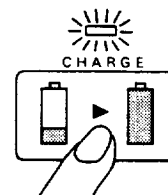

- 2 This will forcibly charge the battery pack.

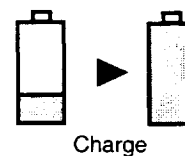

- 3 The CHARGE lamp will go out once the battery pack is fully charged.



Charging will automatically stop if the measuring unit or printer is removed from the station during charging.

It is recommended that you occasionally renew a battery pack, since its operational time will become shorter due to the memory effect even after a full charge.

5. Charging the Spare Battery Pack (Option)



CAUTION Do not recharge any battery pack other than a DURACELL DR10 nickel-hydrogen battery pack.

See "Replacing the battery pack" under "2. The Battery Pack Inside the Printer" on page 20, and install the battery pack you want to charge into the battery box of the printer.

The procedure for charging the battery pack is the same as that described under "Automatic charging" on page 21 for a battery pack inside the printer. Remove the battery pack once it is finished charging.



Measurement Method

Measurement Screen

Perform the procedure described under "2-2. Setting Up the Instrument" in "2. Preparation" (→ P.12). Also perform the procedures described in items 2-3. and 2-4. if necessary.

The screen inside the viewfinder will show the opening screen immediately after the measuring unit's power is turned on. After a few seconds, the measuring unit will enter measurement standby mode and the measurement standby screen will appear.

Sample screen when power is turned on

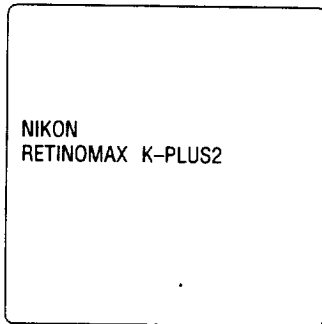

Sample standby screen in REF/KER mode

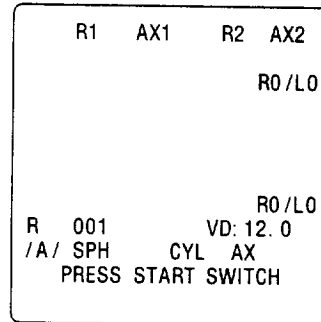

REF/KER measurement screen

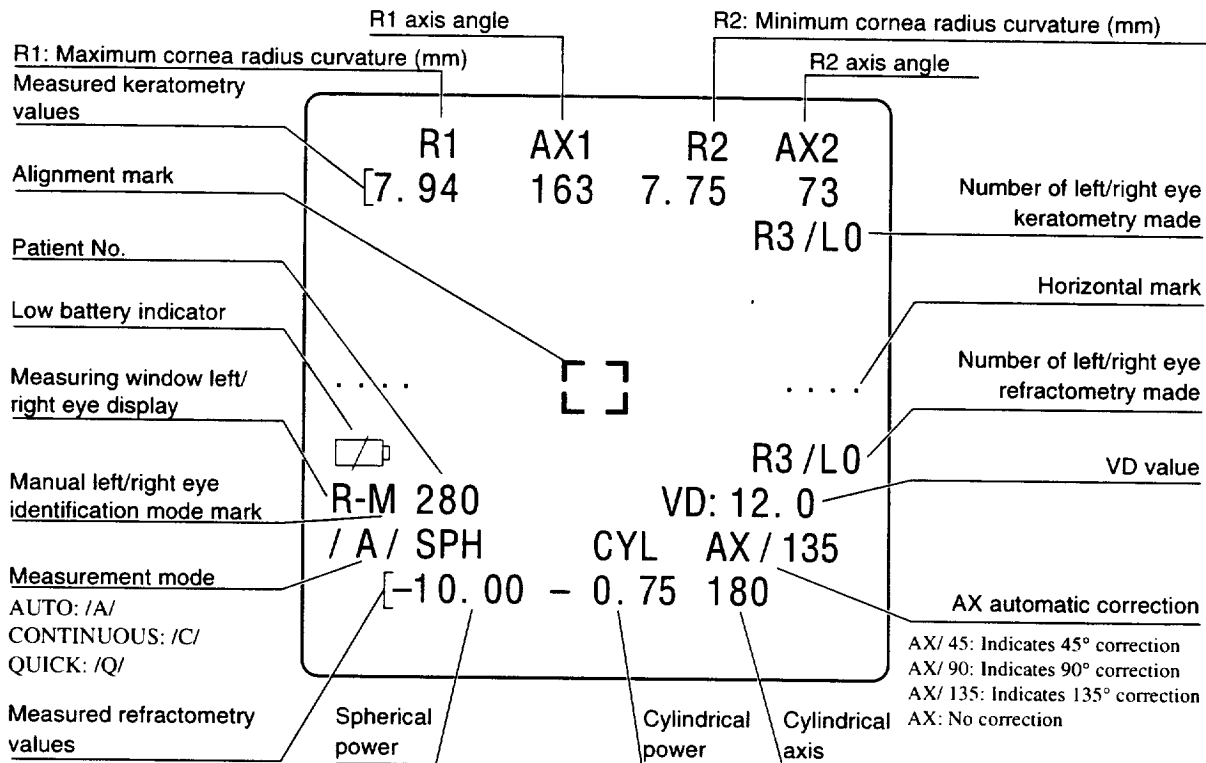

■ Description of Test to Patient Before Measuring

Most patients will be rather nervous, so try to put them at ease.

Briefly explain the unit's operation and purpose as follows.

- "This machine determines the power of the spectacle lenses you should use."
- "You will see a green field inside. Please relax and look at the tree target in the center."
- "Try to keep your eye as still as possible."

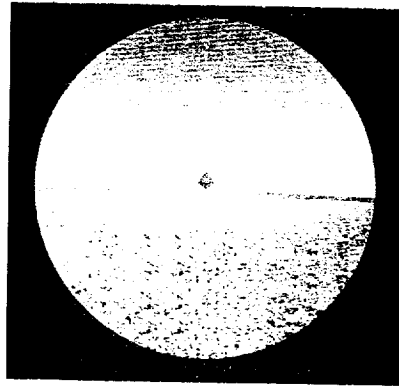

- The image inside will appear sideways or upside down when measuring under a correction of 90° or from the side of the head. The image inside will appear tilted at an angle when measuring under a correction of 45° or 135° .



■ Measurement Modes and R-K Modes of the Unit

This unit possesses two measurement modes and three R-K modes.

Select the measurement mode and R-K mode according to the description given in "READING" in "5-1. SETUP Screen" (→ P.45). You can select "AUTO: Auto measurement mode" or "CONTINUOUS: Continuous measurement mode".

Use the **MODE** key to select the R-K mode. You can select "R/K: Refractometry/Keratometry mode", "R: Refractometry mode" or "K: Keratometry mode".

The table below gives the operation performed when each mode is selected.

| Measurement Mode (READING) \ R-K Mode | R/K Mode (R: REF, K: KER) | R Mode | K Mode |
|--|--|---|--|
| <p>Auto measurement mode (AUTO) (→ P.27) Measurements are made automatically with the unit determining all operations from the beginning to the end. When the light spot enters the alignment mark, the measurement starts (Auto start). When the unit determines the measured values to be stable, the measurement ends (Auto stop). Press the PRINT key if you wish to print out the measured data.</p> | <p>Auto start ↓ Keratometry and Refractometry (Refractometry is made at least 5 times. Keratometry is made at least 3 times.) ↓ Measurements will automatically stop when the unit determines that REF values are stable and when keratometry has been made at least 3 times.</p> | <p>Auto start ↓ Refractometry (Measured at least 5 times.) ↓ Measurements will automatically stop when the unit determines that measured values are stable.</p> | <p>Auto start ↓ Keratometry (Measured at least 3 times.) ↓ Auto stop</p> |
| <p>Continuous measurement mode (CONTINUOUS) (→ P.30) Although measurement are started automatically in the same way as auto measurement mode, measurements do not end automatically but are made continuously. Pressing the START switch will stop measurement momentarily. Pressing it again will restart measurement. Press the PRINT key to print out measured data.</p> | <p>Auto start ↓ Keratometry and refractometry are made continuously. (Refractometry and keratometry are made once each per set.)</p> | <p>Auto start ↓ Refractometry will be made continuously.</p> | <p>Auto start ↓ Keratometry will be made continuously.</p> |

3 - 1 Auto Measurement Mode

- 1 Set the measurement mode to AUTO (/A/) on the setup screen. (→ P.45)
- 2 Press **MODE** and select the R-K mode. The following description is for when the R-K mode selected is "R/K: Refractometry/Keratometry". The measurements made (refractometry and keratometry center measurement) differ for each R-K mode. For details on the measurements made in each R-K mode, see the previous page.
- 3 Show the patient where to sit. Ask the patient to rest both hands on his/her lap and relax.
- 4 Press the START switch on the measuring unit once and release to start measurements. Measurements will be made automatically when alignment is achieved. Repeated measurements will be made at this time. Pressing the START switch again will halt measurement. The next time the START switch is pressed, measurement will resume from the point halted.

 Do not hold down the START switch.

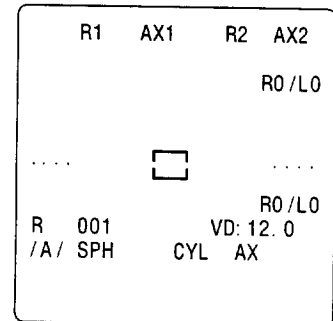

Sample screen during measurement

- 5 Roughly position the patient's eye.
 - Vertical position: Align with the vertical eye position target line.
 - Horizontal position: Align with the horizontal eye position target line.
 - Back/forth direction: Position the measuring window about 40 mm from the eye.

Running your thumb along the groove of the unit's cover makes back/forth positioning easier. Alignment is also easier by looking through the viewfinder after lowering the forehead rest to where it just contacts the patient's eyelashes. (→ P.37)

 When aligning the measuring unit with the patient's eye, take care not to tilt the unit in the vertical or horizontal plane and take care that the patient's eyelashes do not get in the way. (→ P.36)

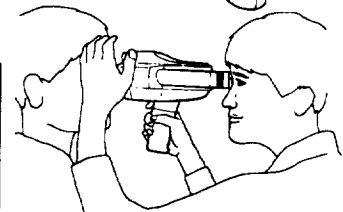
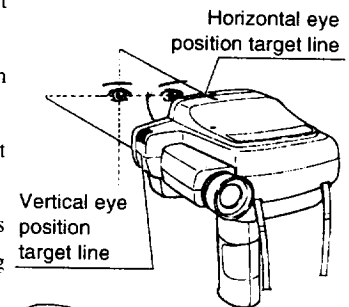

CAUTION

Take care not to strike the measuring head against the patient's nose when aligning the measuring unit and the patient's eye. (For safety, move left and right only after first pulling the measuring unit away from the patient.)

- 6 When the position of the patient's eye is roughly aligned during measurement, look through the the viewfinder. Once the patient's eye appears on the screen, bring the image of the pupil to the center of the screen. Next, move the measuring unit back and forth so that each dot image of mire ring can be seen clearly.

Move the measuring unit close to the patient and the unit will automatically identify whether this is the left or right eye. In automatic left/right eye identification mode, a buzzer will sound during measurement to notify you that a switch has been made between the left and right eyes.

Note that the buzzer will sound continuously in that intermediate position between the left and right eyes where identification is uncertain.

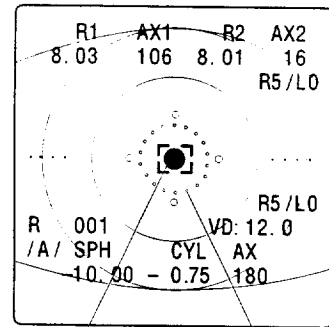

Light spot Mire ring image



CAUTION

Sometimes it is not easy to find the eye when searching through the viewfinder and there is a danger of touching the patient with the measuring unit.

Be sure to roughly align the measuring unit with the patient's line of sight before looking through the viewfinder.



The buzzer sound that occurs in automatic left/right eye identification mode will go off even if the initial setting for BUZZER on the SETUP screen is set to OFF. (→ P.45)

- 7 Measurements will be made automatically when alignment is achieved.

The buzzer will sound each time a measurement is made. A short beep will sound for keratometry and a long beep will sound for refractometry.

During measurement, four light spots will appear for keratometry, while a central light spot will appear for refractometry. This operation will be repeated in refractometry/keratometry mode.

During measurement, an autofogging mechanism will activate. This makes the target slightly blurry. (→ P.40)

- 8 Measurement results are displayed on the screen.
- 9 When making further measurements, measurement will automatically end and the figure at right will appear on the monitor screen. (The figure is a sample of what appears after measurement of the right eye.) Press the START switch at this time to measure the right eye again.
- 10 Perform the same procedure to measure the other eye.
- 11 Once measurements for both eyes are finished, aim the front panel of the measuring unit at the printer and press the  key. (→ P.33)
After printing, representative values will appear inside the viewfinder. Go to step 4 and repeat to continue with more measurements. If no more measurements are needed, perform steps 12 and 13.
- 12 Retract the forehead rest if you were using it.
- 13 Turn off the measuring unit's power switch. Placing the measuring unit in its place on the station will also result in power being turned off automatically.
- 14 Return the measuring unit to its place on the station.

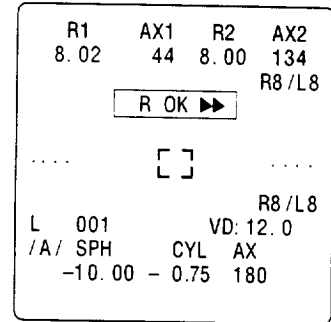

Sample screen when measurement ends

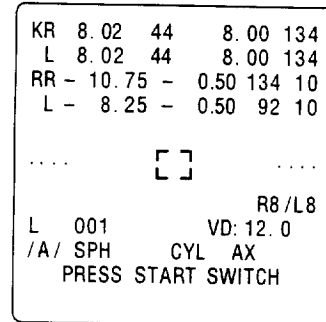

Sample screen after printing

■ The following figures show sample screens for refractometry mode and keratometry mode.

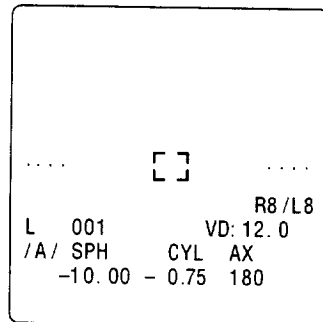

Refractometry screen

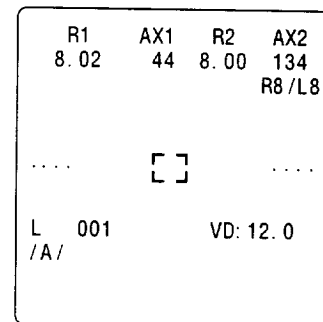

Keratometry screen

■ If there is any foreign matter (such as opacity in the crystalline lens caused by cataracts, other opacity or scratches) obstructing the light from entering the pupil during measurement, it will appear as a black shadow. If there are any black shadows, observe the pupil in retro illumination mode (→P.43) and proceed with further examination of the eye using the slit lamp.

3 - 2 Continuous Measurement Mode

- 1 Set the measurement mode to CONTINUOUS (/C/) on the setup screen. (→ P.45)
- 2 Press **MODE** and select the R-K mode.
- 3 Measure the patient's eyes using the same steps **3** through **9** given in "3-1. Auto Measurement Mode."

- In this mode, measurement does not end automatically, rather it is continuous.
- Be sure to measure each eye at least five times.
Increase the number of measurement even more if there are fluctuations in the measured values or lots of eye movement.
Up to eight refractometry and keratometry results can be stored per eye.

- 4 Press the START switch when you want to end measurement for a given eye. (The measurement will stop temporarily.) Or switch left/right eye measurement in the middle of measurement.
- 5 Measure the other eye the same way.
- 6 Press the **PRINT** key when you want to print out the measurement results. (→ P.33)

3 - 3 Quick Mode

Quick mode, with shortened refractometry times, is useful such as when measurement is difficult due to quick motion of the eye in the case of an infant or nystagmus.

- Although the refractometry time in quick mode is reduced to about half of the usual time, fluctuations in measured values may increase.
- The length of time required for keratometry does not change in quick mode.
- Do not use this mode under normal conditions.
- A "Q" is printed on the print paper to indicate quick mode.

```

R1  AX1  R2  AX2
                                R0 / L0
.....  [ ]  .....
                                R0 / L0
R  001          VD: 12.0
/Q/ SPH        CYL  AX
  
```

- 1 Press **QUICK** and set the measurement mode to **Q**.
- 2 Position the measuring head versus the patient's eye using the same steps 3 through 9 as given in "3-1. Auto Measurement Mode".

- In this mode, measurement does not stop automatically. Measurement is continuous.
- Be sure to take refractometry for each eye at least five times.
The measurement count can be increased even further if the eye moves a lot or if there are fluctuations in the measured values.
Up to eight refractometry and keratometry results can be stored per eye.

- 3 Press the measurement switch to end measurements for a given eye. (The measurement will stop temporarily.) Or switch left/right eye measurement in the middle of measurement.
- 4 Measure the other eye in the same way.
- 5 Press the **PRINT** key when you want to print out the measurement results. (→ P.33)

3 - 4 Cornea Periphery Measurement (PERI)

- 1 Press the **PERI** key. The unit will enter cornea periphery keratometry mode and the screen will change.
- 2 Roughly align the mire ring and alignment marks and press the **START** switch. (This is the same procedure as used for normal keratometry.) Light spots will flash and measurement will repeat. Measurement of the central area and horizontal peripheral area will be performed alternately.
- 3 After repeating measurements several times, press the **START** switch. The measurement will end and the cursor will move to the bottom.

Peripheral measurement in the horizontal direction will end. If measurements in the vertical direction are unnecessary, press the **PRINT** key and print out the data.

When printout is selected, refractometry values, keratometry values, and cornea periphery values, will all be printed.

If vertical measurements are also to be performed, proceed to the next measurement without pressing the **PRINT** key.

Vertical measurement

- 4 Rotate the measuring unit 90° (in the same direction shown in the figure). Check that the cursor is as shown in the figure at the right and that the upper direction mark appears at the top.
- 5 Perform measurement. Measurement is made in the same way as for the horizontal direction.
- 6 Measure several times and then press the **PRINT** key.

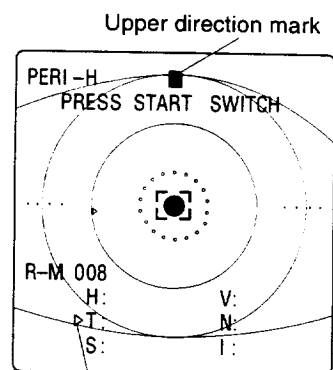

Cursor

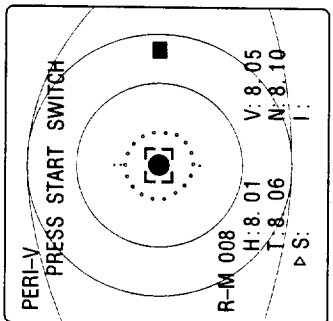
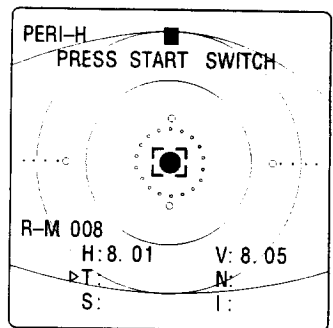

- During peripheral measurements, right/left eye identification must be performed manually.
- Do not use the forehead rest when measuring in the vertical direction as it may strike the patient in the other eye.
- Measurements may be impossible due to the patient's eyelids or eyelashes obstructing the measuring beam during measurements in the vertical direction. If this happens, have the patient open their eyes as widely as possible and try measuring again.

3 - 5 Printing

Use the supplied printer to print out measured data.

- 1 Properly install a printer paper roll. (→ P.58)
- 2 After measurement, aim the front panel (patient side) of the measuring unit at the light receiving window of the printer and press the  key. (Continue aiming the measuring unit until the buzzer stops sounding.)

When the  key is pressed, data is sent to the printer via infrared communication and then printed.

Once the printer has successfully received the data, the buzzer will beep and the data lamp will light for about 1 second.

The  key functions according to the settings in "5-3. Print Setup Screen" (→ P.47) for PRT RS OUT described and in "5-7. Output Setup Screen" (→ P.52).

- To make an eye print, set the EYE PRINT setting to ON on the "5-3. Print Setup Screen". (→ P.47) This setting causes an eye print to be output after the usual printing of measured data.

- 3 Measured values are output by the printer on printed paper. Pull the paper toward you to cut it off the paper roll.

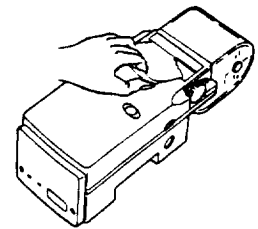
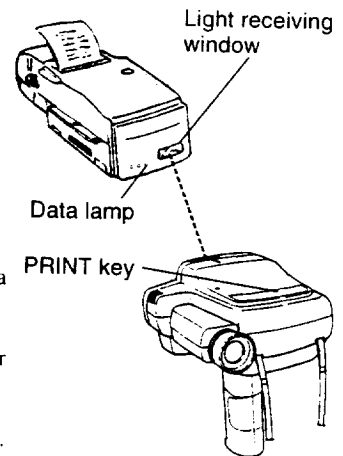

- If the printer does not function properly while data is being sent to the printer from the measuring unit due to a person walking between the measuring unit and the printer, the data lamp on the printer will light yellow and the buzzer will sound. Sometimes the printer will not function at all if light from the measuring unit cannot reach the printer. If this happens, get closer to the printer and press the  key again to send the data. This same information may be printed any number of times up until the next measurement is made.

- Printer for Retinomax and Retinomax K-plus can't be used for Retinomax K-plus2.

3 - 6 Using Multiple Printers

When using two or more printers in the same room, be sure to set the dip switches on the printers as follows to avoid crossed transmissions of data.

Match the printer identification number with that for the measuring unit.

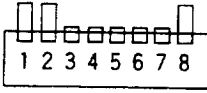
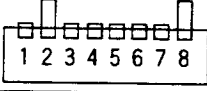
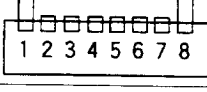
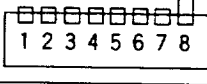
| ID No. | Dip Switch Settings |
|--------|---|
| 1 |  1 2 3 4 5 6 7 8 Factory setting |
| 2 |  1 2 3 4 5 6 7 8 |
| 3 |  1 2 3 4 5 6 7 8 |
| 4 |  1 2 3 4 5 6 7 8 |

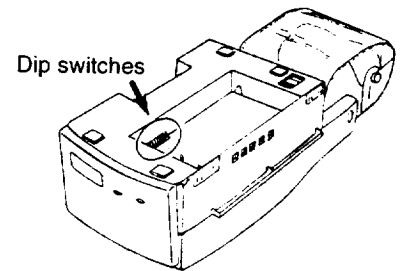

Example of sending data from the measuring unit to the printer

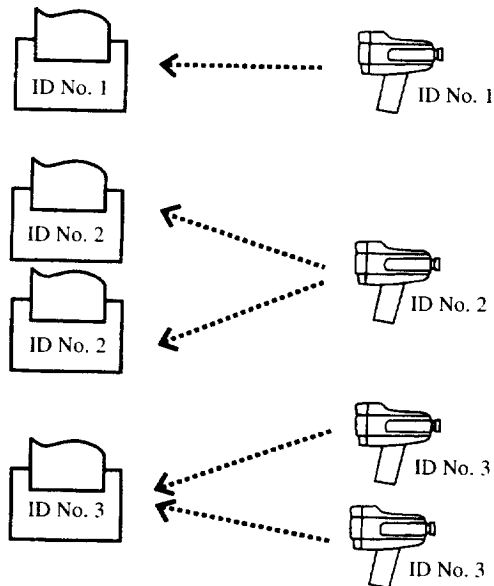

3 - 7 For More Effective Measurements

1. When the Left/Right Eye Identification is Difficult

- Note the following points to ensure proper left/right eye identification.
 - Do not allow your hand to block the left/right identification sensor when placing your hand between the patient's face and the measuring unit in order to stabilize the unit.
 - Make measurements from straight on the patient's face as shown in the figure below. Sometimes proper identification is not possible when measuring from a vertical or horizontal angle.

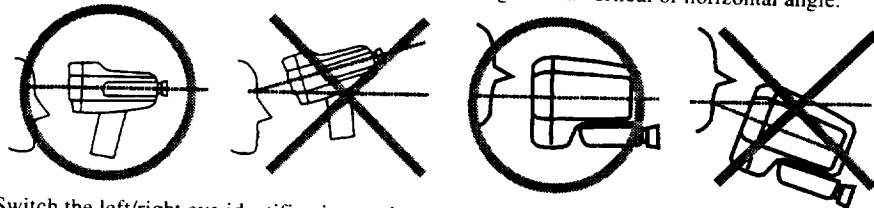

- Switch the left/right eye identification setting to manual identification if identification is poor even while following the above recommendations (such as when the left-right eye indicator reads R even though the measurement window is near the left eye).

Left/right eye identification may not be possible particularly in the following cases.

- When the patient is wearing a mask
- When there is a lot of hair hanging down over the cheeks of a female patient
- When face of the patient is small such as with a child or infant

Manual switching is necessary when measuring from the top of the face or from the side or at an angle.

- How to switch from automatic left/right identification mode to manual mode

Press the **R/L** key on the measuring unit switch panel.

- The unit enters right eye measurement mode, the R/L auto lamp lights, and the right eye lamp (R) lights.
- Press the **R/L** key again and the unit enters left eye measurement mode and the left eye lamp (L) lights.

The mode will switch between left and right each time the **R/L** key is pressed thereafter.

Press the **PRINT** key when you want to return to automatic left/right eye identification mode.



(This is true except when the RL SENSE setting described in "5-2. Hold Mode Setting Screen" (→ P.46) has been manualled.)

After the **PRINT** key is pressed and once a new measurement is made, this setting data is erased. If after pressing the **PRINT** key (will print if there is set data), press the **R/L** key again to put the unit in manual left/right eye identification mode.

2. Measurements from 45°, 90° and 135° Positions

The Ax setting is required when measuring the patient in bed from an angle of 45°, 90° and 135°.

Set the automatic correction angle as shown in the figure at the right depending on the measurement position.

Press the  key on the measuring unit switch panel once and correct the Ax cylindrical axis angle for 45°, 90°, and then 135°. Next press the  key again and cancel correction. During cylindrical axis angle correction of 45°, 90° and 135°, the Ax switchover indicator lamp lights, and the left/right eye identification mode switches to manual mode.

Correction is also canceled at the same time that data is printed out when the  key is pressed. (This is true except when the AX ROTATION setting described in "5-2. Hold Mode Setting Screen" (→ P.46) has been held. An Ax correction mark (→ P.34) is printed on the printer paper during printing.

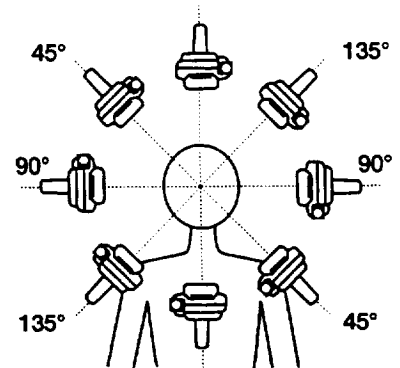

3. Using the Forehead Rest

When there is a lot of eye movement or when the operator cannot hold the measuring unit still, measurements can be made easier by using the forehead rest.



CAUTION If the patient moves a lot such as with a small child or infant, do not use the forehead rest as there is a danger of scratching the patient's face.

- 1 When you push the center of the forehead rest in the direction of the arrow (▷), the entire forehead rest will pop out.
- 2 Gently press the forehead rest against the patient's forehead and align the measurement distance while carefully pushing in toward the patient.
- 3 Push the forehead rest back in the direction of the arrow when it is not being used.
- 4 When placing the measuring unit on the station be sure to retract the forehead rest.

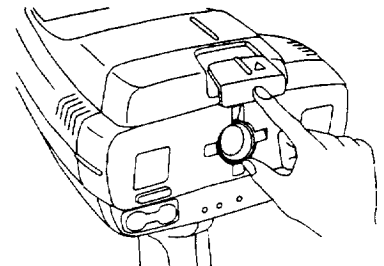

4. When Measurements are Unstable (in refractometry)

- If the patient's eyelashes droop over the eye being measured, have him/her open his/her eye as widely as possible. If the eyelashes are still in the way, it is often effective to have an assistant or the patient gently raise the patient's eyelid with the tip of the finger.
- Measurements may not be possible if the patient blinks during measurement.
- Measurements are either not possible, or if possible correct values are not obtainable, if the patient is suffering from an eye disease such as a cataract, abnormal retina, opaque condition of the cornea, crystalline lens or vitreous body.
- Measurements are either not possible, or if possible correct values are not obtainable, if the patient's pupil has a diameter of 2.5 mm or less.
- Measurements cannot be made when $\langle S + C \rangle$ is outside the range -18 to $+23D$, or when $\langle C \rangle$ is outside the range -12 to $+12D$.

■ Measurement with contact lenses on

Measurement is usually possible. However, if the contact lens is not properly fitted, the correct values may not be obtained. Any dirt or scratches on the contact lenses may result in measurement failure.

■ Measurement with glasses on

Measurement is possible if the lens is tilted slightly. If the lens is tilted at too high an angle, correct values will not be obtained. Measurement may not be possible if light is reflected off the lens surface into the measurement window, or if the glasses have colored lenses of low transmission.

5. Notes

- Note the following points since astigmatism occurs more easily when eyelashes droop.
 - Hold the measuring unit level at the same height as the patient's eye.
(Note that eyelashes may get in the way if measurements are made with the unit angled downward.)

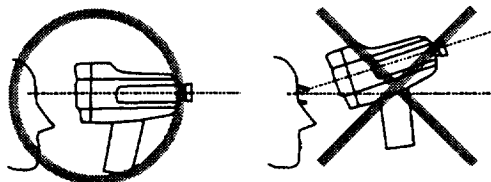

- Eyelashes may be hard to see through the viewfinder at the point of focus. Pay attention while bringing the measuring unit closer to the patient during focusing as you should be able to see whether or not the eyelashes are drooping. If they are drooping, have the patient open his/her eye as widely as possible.



- The cylindrical axis may shift if the measuring unit is not aligned with the eye in the horizontal plane. Pay attention to this before looking through the viewfinder.

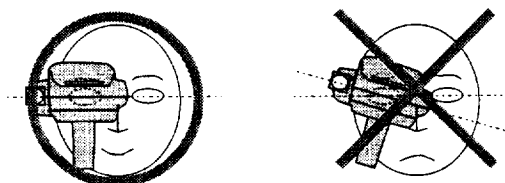

- Shaking of your hands may be prevented by keeping your arms firmly down against your body while holding the measuring unit.
Hands shake much more easily when your arms are not against your body.

6. Playing the Melody

The measuring unit will begin playing a melody when the **QUICK** key is held down. The melody may be stopped by pressing the START switch or the **QUICK** key again. Sometimes infants will fuss and cannot be measured when the measuring unit approaches their face. In such cases, you can use the melody feature to hold their interest and allay their fears.

3 - 8 Miscellaneous

1. Automatic Fogging

The auto fogging mechanism aids measurement by facilitating patient eye fixation and minimizing eye accommodation. Auto fogging will activate automatically when the measuring unit and patient's eye are aligned.

Once the measurement position has been aligned, the target will become blurry due to fogging.



Automatic measurements are actually performed after this occurs.

The unit will output a beep signal for each measurement performed.



Next, the target will remain fogged to the patient.



The next measurement is then performed.

2. When Keratometry is Impossible

When keratometry is impossible, check that the eyelashes or eyelids are not blocking the measuring light. Have the patient open his/her eye wide so that the measuring light is not blocked and then take the measurement.

During refractometry/keratometry or keratometry, lights for keratometry will appear on the patient's cornea and can be seen on the TV monitor. (The figure on the right depicts R/K mode.)

If these keratometry lights cannot be seen, can only be partially seen, or appear hazy, the measuring light is being blocked. This may be due to blocking by the eyelashes or eyelids, blinking or pathology of the cornea.

If the nasal side (N) cannot be measured during peripheral keratometry, check that the patient's face is facing straight-forward and that his or her nose is not blocking the measuring light.

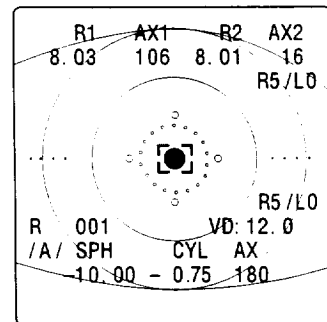

Example of blocked keratometry lights

3. IOL Patients

This unit can measure IOL patients (lenses inside the eyes) using the same procedure as normal eyes without any switching of switches.

4. Measuring a Hard Contact Lens Base Curve

(The base curve of a soft contact lens cannot be measured.)

- 1 Place several drops of water on the supplied hard contact lens holder.
- 2 Place the hard contact lens on the holder (with the side to be measured facing the measuring unit).
- 3 Take measurements using normal keratometry procedures.

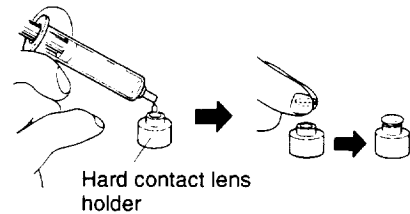

5. When Measurement Values Cannot be Obtained

The measuring unit will indicate when normal measurements cannot be made. Some kind of problem is likely when measurement values cannot be obtained even though proper alignment has been achieved.

- If a patient has droopy eyelashes, it will be necessary to make the eyelashes stay out of the outer line on the alignment mark on the TV monitor screen. If necessary, have the patient or an assistant gently lift the eyelid with their fingertip.
- Measurements may be automatically made again if the patient blinks during measurement.
- Measurements are either not possible, or if possible correct values are not obtainable, if the patient is suffering from an eye disease such as a cataract, abnormal retina, opaque condition of the cornea, crystalline lens or vitreous body.
- Measurements cannot be made when $\langle S + C \rangle$ is outside the range -18 to $+23D$, or when $\langle C \rangle$ is outside the range -12 to $+12D$.
- Measurement with contact lenses on: Measurement is usually possible. However, if the contact lens is not properly fitted, the correct values may not be obtained. Any dirt or scratches on the contact lenses may result in measurement failure.
- Measurement with glasses on: Measurement is possible if the lens is tilted slightly. If the lens is tilted at too high an angle, correct values will not be obtained. Measurement may not be possible if light is reflected off the lens surface into the measurement window, or if the glasses have colored lenses of low transmission.

6. Representative Values for Refractometry and Keratometry

Representative values are a guide to help you choose which value to choose out of the several measured values found. In a printout, an asterisk (*) indicates the representative values. For a sample printout, please see P.34. Consider the following points when selecting one value from several measured refractometry values that vary widely.

■ Substantial variance of S

The patient's eye may be accommodating. Re-measure the eye.

■ Substantial variance of C and AX

AX will tend to be somewhat unstable when the eye is weak astigmatically (has a C value of less than 0.5D). Other causes may include the following:

- Eyelashes are occluding the pupil.
- The pupil diameter is less than the minimum measurable diameter of 2.5 mm.
- Part of the eye is opaque or irregularly astigmatic.

Normally a low confidence value will be reported in the above situations.

If the eyelashes or pupil diameter affect the measurement, you should re-measure the eye paying close attention to these factors.

7. Refractometry Confidence Values

A confidence value indicates how widely measured results vary. It is only displayed when measurements are made three or more times and is printed at the right of printed results. For a sample printout, please see P.34.

- 8 or higher: Variance is low.
- 7 or less: There is variance. Care is required in the handling of these measured results.

8. Auto Power Off

The unit will automatically power off if no switches or keys have been operated for three or more minutes. Turn on the power by pressing the power switch when you need to make measurements again.

9. Using a Password

When a password has been set, that password is required to change the printed message. The presence of a password makes finding the measuring unit easier if it is stolen and can also help prevent its theft. Once a password is set settings cannot be changed or canceled without entering that same password. Do not forget the password. (→ P.54)

4

Retro Mode

Retro mode allows you to observe the inside of a pupil more easily and to more readily understand measurement status when the measured values vary or when the confidence value is low.

- 1 Press the **RETRO** key.

The unit will enter Retro Mode.

In Retro Mode, fixation chart brightness is automatically switched to "L".

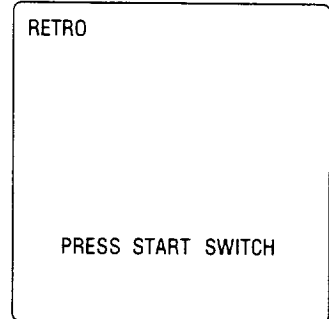

- 2 Press the **START** switch.

The light spot in the center will light. Light illuminating the outside area of the eye such as the iris will go out. If there is foreign matter obstructing the measuring light such as opacity in the crystalline lens, it will appear as a black shadow on the screen.

- Foreign matter may be seen more clearly if the image of the patient's eye is decentered slightly. In particular, an opacity at the center may not be visible. Direct the measuring light so that it is not obstructed by an opacity.
 - If external illumination such as from a fluorescent room lamp enters the patient's eye, foreign matter in the pupil may not be visible. Be sure that no external light enters the patient's eye.
- 3 Press the **START** switch to return to the status in step 1.
 - 4 Pressing the **RETRO** key will resume the previous measurement mode.

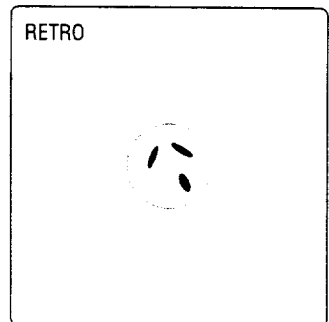



Making Various Settings (Setup)

User Settings

The following settings can be made for the measuring unit.

- Pressing the  key will cause the corresponding screen shown here to appear.
- : Will appear when a password has been set.

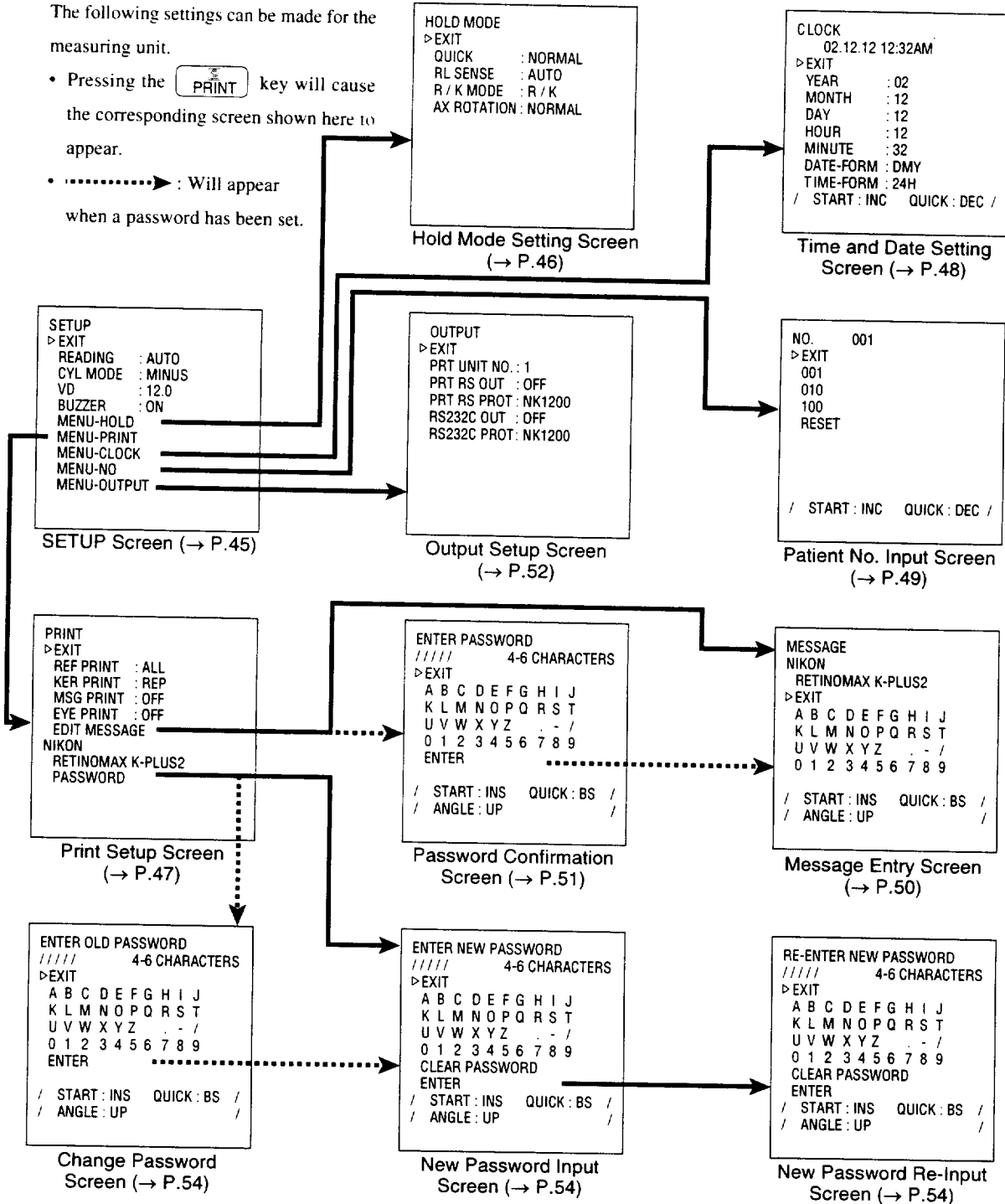

5 - 1 SETUP Screen

The SETUP screen appears in the viewfinder when the **MODE** and **R/L** keys are pressed simultaneously. You can change settings and move to sub-menus by selecting from the items displayed on the SETUP screen.

```

SETUP
▷EXIT
READING : AUTO
CYL MODE : MINUS
VD      : 12.0
BUZZER  : ON
MENU-HOLD
MENU-PRINT
MENU-CLOCK
MENU-NO
MENU-OUTPUT
    
```

■ Selecting items

An item is selected when the cursor (▷) is located to the right of that menu item. Use the following keys to move the cursor.

R/L key: Moves the cursor (▷) down.

 key: Moves the cursor (▷) up.

■ Setting item contents

Press the **PRINT** key while the item is selected (cursor ▷ located on the same line).

Each time the **PRINT** key is pressed, the unit will cycle through the possible settings for that item in order. Make the desired setting. That setting will take effect once you exit from the setting screen.

Depending on the item, pressing the **PRINT** key may move to another screen such as a sub-menu.

| Item | Setting Contents |
|-------------|--|
| EXIT | Moves to measurement mode. |
| READING | Switches the measurement mode: AUTO → CONTINUOUS |
| CYL MODE | Switches the astigmatic mode: MINUS (-) → PLUS (+) → MIX (±) |
| VD | Sets the cornea vertex distance (VD): 12.0 → 13.5 → 13.75 → 15.0 → 16.0 → 0.0 |
| BUZZER | Turns the buzzer on/off: ON → OFF |
| MENU-HOLD | Moves to the Hold Mode Setting Screen. (→ P.46) |
| MENU-PRINT | Moves to the Print Setup Screen. (→ P.47) |
| MENU-CLOCK | Moves to the Time and Date Setting Screen. (→ P.48) |
| MENU-NO | Moves to the Patient No. Input Screen. (→ P.49) |
| MENU-OUTPUT | Moves to the Output Setup Screen. (→ P.52) |

Settings shown in **bold** represent factory defaults.

5 - 2 Hold Mode Setting Screen

This function is used to disable some of the initialization performed when data is printed or the power is turned on.

The method used to select items and make settings is the same as described in "5-1. SETUP Screen".

```
HOLD MODE
EXIT
QUICK      : NORMAL
RL SENCE   : AUTO
R/K MODE   : R/K
AX ROTATION: NORMAL
```

| Item | Setting Contents |
|-------------|--|
| EXIT | Moves to SETUP screen. |
| QUICK | HOLD: Holds the previous QUICK mode at initialization. NORMAL: Cancels QUICK at initialization. |
| RL SENSE | MANUAL: Always switches right/left eye identification to manual mode. AUTO: Sets automatic right/left eye identification at initialization. |
| R/K MODE | HOLD: Holds the previous R/K mode at initialization. R/K: Sets refractometry/kerotometry mode at initialization. |
| AX ROTATION | HOLD: Holds the previous AX rotation mode at initialization. NORMAL: Cancels axis correct at initialization. |

Settings shown in **bold** represent factory defaults.

5 - 3 Print Setup Screen

This screen is used to make printing-related settings.

The method used to select items and make settings is the same as described in "5-1. SETUP Screen".

```

PRINT
▷EXIT
REF PRINT : ALL
KER PRINT : REP
MSG PRINT : OFF
EYE PRINT : OFF
EDIT MESSAGE
NIKON
RET INOMAX K-PLUS2
PASSWORD
  
```

| Item | Setting Contents |
|--------------|---|
| EXIT | Moves to SETUP screen. |
| REF PRINT | ALL: Prints all measured refractometry values. REP: Prints only representative measured refractometry values. OFF: Does not print measured refractometry values. |
| KER PRINT | ALL: Prints all measured keratometry values. REP: Prints only representative measured keratometry values. OFF: Does not print measured keratometry values. |
| MSG PRINT | ON: Prints a message at time of printing. OFF: Does not print a message at time of printing. |
| EYE PRINT | ON: Prints an eye print. ON BY SW: Prints an eye print when the  key is pressed for more than 1 second. OFF: Does not print an eye print. |
| EDIT MESSAGE | Performs password confirmation and message entry. |
| PASSWORD | Allows the password to be input and changed. |





Settings shown in **bold** represent factory defaults.

5 - 4 Time and Date Setting Screen

This screen is used to set the time of the internal clock and specify the format to use when printing the date.

The method used to select items and make settings is the same as described in "5-1. SETUP Screen". Other key operations specified for this screen are shown below.

```
CLOCK
02.12.12 12:32AM
▷EXIT
YEAR      : 02
MONTH     : 12
DAY       : 12
HOUR      : 12
MINUTE    : 32
DATE-FORM : DMY
TIME-FORM : 24H
/  START : INC  QUICK : DEC /
```

| Item | Setting Contents |
|-----------|---|
| EXIT | Moves to SETUP screen. |
| YEAR | Sets the year: Start switch: +1 year.  key: -1 year |
| MONTH | Sets the month: Start switch: +1 month.  key: -1 month |
| DAY | Sets the day: Start switch: +1 day.  key: -1 day |
| HOUR | Sets the hour: Start switch: +1 hour.  key: -1 hour |
| MINUTE | Sets the minute: Start switch: +1 minute.  key: -1 minute |
| DATE-FORM | Selects the date print format: DMY → MDY → YMD |
| TIME-FORM | Selects the time print format: 24H → AM/PM (12H) |

Settings shown in **bold** represent factory defaults.

- The clock display on the second line of this screen changes in accordance with the setting contents for date and time print formats.

5 - 5 Patient No. Input Screen

This screen is used to set the patient identification number. Any number from 001 to 999 may be set.





The method used to select items and make settings is the same as described in "5-1. SETUP Screen". Other key operations specified for this screen are shown below.

```

NO.      001
▷EXIT
001
010
100
RESET

/  START : INC  QUICK : DEC  /

```

| Item | Setting Contents |
|-------|---|
| EXIT | Moves to SETUP screen. |
| 001 | Sets the one's place: The START switch increments this by +1 (Ex. 097 → 098) The  key decrements this by -1 (Ex. 097 → 096) If the patient number is currently at 001, pressing the  key does nothing. |
| 010 | Sets the ten's place: The START switch increments this by +10 (EX: 097 → 007) The  key decrements this by -10 (Ex. 097 → 087) |
| 100 | Sets the hundred's place: The START switch increments this by +100 (EX: 097 → 197) The  key decrements this by -100 (Ex. 097 → 997) |
| RESET | Pressing the START switch here resets the patient number to 001. (Ex. 097 → 001) |

5 - 6 Message Entry Screen

Pressing the  key when the cursor position is at "EDIT MESSAGE" on "5-3. Print Setup Screen" will bring up the Message Entry Screen. This screen is used to set a message to be inserted at the end of a printout. If a password has been set, the Password Confirmation Screen (→P.51) will appear first, followed by the Message Entry Screen. A message up to 48 characters (24 characters x 2 lines) may be entered. The method used to select items and make settings is the same as described in "5-1. SETUP Screen". Other key operations specified for this screen are shown below.

```
MESSAGE
NIKON
RETINOMAX K-PLUS2
▷EXIT
A B C D E F G H I J
K L M N O P Q R S T
U V W X Y Z . - /
0 1 2 3 4 5 6 7 8 9

/START : INS QUICK : BS /
/ANGLE : UP /
```

■ Entering and Setting a Message

Move the cursor (▷) to the line containing the desired alphabetic (A B C...) or numeric (0 1 2...) character and then enter that character or number by selecting it as described below.

 key: Moves the cursor to the right.

 key: Moves the cursor down.

 key: Moves the cursor up.

 key: Deletes the character or number just entered.

START switch: Enters the character or number at the cursor position.

The character or number entered by pressing the START switch will be displayed in the order entered in the message area (lines 2 and 3) on the screen.

When you are finished entering the message, align the cursor with "EXIT" and press the  key to set the entered message.

| Item | Setting Contents |
|---------------------------------------|---|
| EXIT | Moves to SETUP screen. |
| ABCDEFGHIJ KLMNOPQRST UVWXYZ.-/ | Enters an alphabetic, space, period, minus or dash. |
| 0123456789 | |
| /START:INS QUICK:BS/ /ANGLE:UP / | Enters a number. |
| | Displays a description of the operation keys. |

■ Password Confirmation

Enter the password so that it may be confirmed. The entry method used is the same as that for entering a message. When you are finished entering the password, align the cursor with "ENTER" and press the  key to settle the entry.

```

ENTER PASSWORD
/////      4-6 CHARACTERS
▷EXIT
A B C D E F G H I J
K L M N O P Q R S T
U V W X Y Z . - /
0 1 2 3 4 5 6 7 8 9
ENTER

/START:INS QUICK:BS /
/ANGLE:UP /
    
```





5 - 7 Output Setup Screen

This screen is used to set the output device.

The method used to select items and make settings is the same as described in "5-1. SETUP Screen".

```



OUTPUT
▷EXIT
PRT UNIT NO. : 1
PRT RS OUT  : OFF
PRT RS PROT : NK1200
RS232C OUT  : OFF
RS232C PROT : NK1200
    
```



| Item | Setting Contents |
|--------------|--|
| EXIT | Moves to SETUP screen. |
| PRT UNIT NO. | <p>Sets the device ID number for the printer: 1 → 2 → 3 → 4 → SELECT</p> <p>Setting SELECT allows you to specify the printer at the time of data transmission.</p> <p>When this setting is used, use the  key for 1,  key for 2,  key for 3, and  key for 4.</p> <p>* The ID number for both the printer and measuring unit is set to "1" at the factory. If the printer ID number is set to other than "1" at the measuring unit, then the ID number at the printer must be set to that same number. (The printer's ID number is changed using the printer's dip switches. → P.35 "3-6 Using Multiple Printers".)</p> |
| PRT RS OUT | <p>The following types of data can be sent to an external device from the external communication connector of the printer.</p> <p>REF: Sends measured refractometry data.</p> <p>KER: Sends measured keratometry data.</p> <p>REF/KER: Sends measured both refractometry and keratometry data.</p> <p>OFF: No data is sent.</p> |
| PRT RS PROT | <p>Sets the transmission speed when sending data to an external device from the printer's external communications connector.</p> <p>NK1200: Sends the data in NK format at 1200 bps.</p> <p>NK9600: Sends the data in NK format at 9600 bps.</p> |

| Item | Setting Contents |
|-------------|---|
| RS232C OUT | Sets the type of data to be sent when sending data from measuring unit's/AC adapter's communication connector. REF: Sends measured refractometry data. KER: Sends measured keratometry data. REF/KER: Sends measured both refractometry and keratometry data. OFF: No data is sent. |
| RS232C PROT | Sets the transmission speed when sending data to an external device from the unit's/AC adapter's communication connector. NK1200 : Sends the data in NK format at 1200 bps. NK9600 : Sends the data in NK format at 9600 bps. |

Settings shown in **bold** represent factory defaults.

5 - 8 Password Input Screen

Pressing the  key when the cursor position is at "PASSWORD" on "5-3. Print Setup Screen" will bring up the "New Password Input Screen". This screen is used to set the password consisting of 4 to 6 letters. The password entry method is the same as that for entering a message (→P.50). When you are finished entering the password, align the cursor with "ENTER" and press the  key. The screen will go to the "New Password Re-input Screen". Here input the same password again for confirmation. Finally align the cursor with "ENTER" and press the  key to settle the entry.

If the password has been set when pressing the  key with the cursor positioned at "PASSWORD" on "5-3. Print Setup Screen", the screen will go to "Change Password Screen". Here input the set password and press the  key with the cursor positioned at "ENTER". Then the screen will change to "New Password Input Screen" where you can enter another password by the same procedures above.

Password setting can be cancelled by pressing the  key with the cursor positioned at "CLEAR PASSWORD" on "New Password Input Screen" or "New Password Re-input Screen".

Change Password Screen

```

ENTER OLD PASSWORD
/////      4-6 CHARACTERS
▷EXIT
A B C D E F G H I J
K L M N O P Q R S T
U V W X Y Z . - /
0 1 2 3 4 5 6 7 8 9
ENTER

/START: INS QUICK:BS /
/ANGLE: UP /
    
```

New Password Input Screen

```

ENTER NEW PASSWORD
/////      4-6 CHARACTERS
▷EXIT
A B C D E F G H I J
K L M N O P Q R S T
U V W X Y Z . - /
0 1 2 3 4 5 6 7 8 9
CLEAR PASSWORD
ENTER
/START: INS QUICK:BS /
/ANGLE: UP /
    
```

New Password Re-input Screen

```

RE-ENTER NEW PASSWORD
/////      4-6 CHARACTERS
▷EXIT
A B C D E F G H I J
K L M N O P Q R S T
U V W X Y Z . - /
0 1 2 3 4 5 6 7 8 9
CLEAR PASSWORD
ENTER
/START: INS QUICK:BS /
/ANGLE: UP /
    
```

 key: Moves the cursor to the right.

 key: Moves the cursor down.

 key: Moves the cursor up.

 key: Deletes the character or number just entered.

START switch: Enters the character or number at the cursor position.

About Passwords

Once a password is set, that password will be required in order to change or delete the contents of a message. If you somehow forget the password, it will not be possible to change the message, so be sure you do not forget the password. If you forget the password but wish to change the message, contact your nearest Nikon representative.



Data Transmission to External Devices

A connector for connecting to external devices is located on the printer and AC adaptor (option).

This connector conforms to the EIA RS-232C interface specification. Measured values can be sent to external devices such as Nikon's Auto OP Tester and commercially available PCs via this connector.

When connected to Nikon's OT-3A, OT-5A, OT-7A, OT-8A or Remote Vision measured data from the Retinomax K-plus 2 can be automatically set as lens diopter when starting self-testing with the Auto Optester.

This allows quick measurement of visual acuity.

Contact your dealer for details on this interface.

■ Wireless transmission to Remote Vision

The measuring data can be sent to Nikon's Auto Optester Remote Vision by wireless transmission with infrared rays. Set the output setup (→P.52 and P.53) for this wireless transmission regarding the Remote Vision as a printer.

- Set to "REF" or "REF/KER" for "PRT RS OUT"
- Set the item "PRT UNIT NO" to the setting according to the "Setting for wireless communication with the Retinomax" in the "Communication setup" on the Remote Vision. (Standard:1) Refer also to the instruction manual of Remote Vision.

■ Transmission via printer

The measuring data can be sent to the external devices via printer with an optional communication cable connected.

- Set the item "PRT RS OUT" to the setting as desired. (Refer to Note 1 below.) (→P.52)
- Set the item "PRT RS PROT" to the setting according to the device to be connected. (Refer to Note 2 below.) (→P.52)

■ Direct transmission from the measuring unit

The measuring data can be directly sent to the external devices from the measuring unit with an optional direct communication cable connected to the communication connector. In this case battery built in the unit is used as a power.

- Set the item "RS232C OUT" to the setting as desired. (Refer to Note 1 below.) (→P.53)
- Set the item "RS232C PROT" to the setting according to the device to be connected. (Refer to Note 3 below.) (→P.53)

■ Transmission via AC adaptor

The measuring data can be sent to the external devices via AC adaptor with an optional communication cable connected.

- Set the item "RS232C OUT" to the setting as desired. (Refer to Note 1 below.) (→P.53)
- Set the item "RS232C PROT" to the setting according to the device to be connected. (Refer to Note 3 below.) (→P.53)

Note 1:

- * Set "REF" when sending data to a Nikon Auto Optester OT-3A, OT-5A, OT-7A, or OT-8A.
- * Set "REF" or "REF/KER" when sending data to a Nikon Auto Optester Remote Vision.

Note 2:

- * Set "NK1200" when sending data to a Nikon Auto Optester OT-3A, OT-5A, OT-7A, OT-8A, or Remote Vision.

Note 3:

- * Set "NK1200" when sending data to a Nikon Auto Optester OT-3A, OT-5A, OT-7A, or OT-8A.
- * Recommended setting is "NNKE" when sending data to a Nikon Auto Optester Remote Vision.

AC adaptor (option)

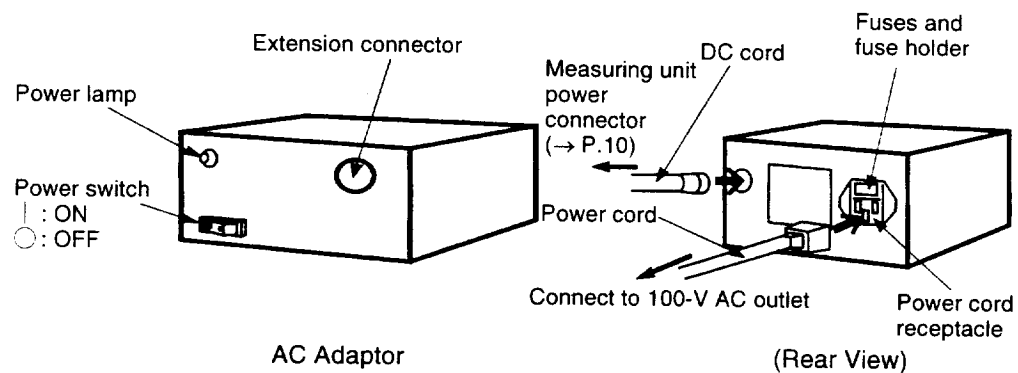

- Turn off the power switches on the measuring unit and AC adaptor before connecting each other.
- Turn on the power switches on the measuring unit and AC adaptor before use.

7 - 1 Checking Measurement Accuracy

Before using this unit check its measurement accuracy using the model eye provided.

For details on how to measure using the model eye and checking accuracy, refer to "2. Preparation" (→ P.12).

7 - 2 Replacing a Printer Paper Roll

When printer paper is about to run out, a red line will appear on the paper. In this case, replace the paper roll.

- 1 Turn the printer around, open the paper holder cover, and pull the two paper holder knobs toward the outside.
Lower the release lever toward you to remove the remaining paper.

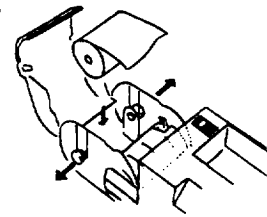

- 2 Peel off the tape used to secure the paper.

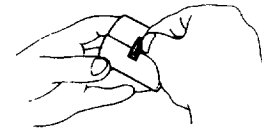

- 3 Crease the paper past the location beyond of the adhesive.

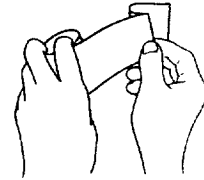

- 4 Carefully tear the paper along the crease.
(Tearing the paper in this way avoids printing on the part with adhesive and makes it easier to insert in the printer.)

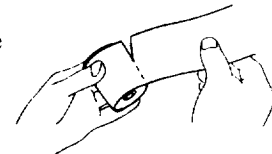

- 5 Set the paper in place as shown in the diagram so that the paper holder knobs hold the paper core.

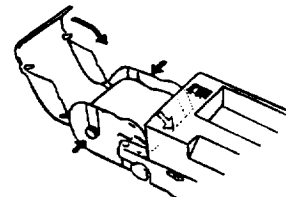

Next, continue with the steps in **1** or **2** below depending on whether or not a battery pack (option) is being used.

1 When a battery pack (option) is not being used

- 6** Insert the paper straight into the printer.
- 7** Lower the release lever toward the front and turn the paper feed knob so that paper comes out of the output port. If the paper comes out awry, release the release lever and straighten the paper with your finger.
Lower the release lever toward the front.
- 8** Close the paper holder cover until it catches in place.
- 9** Connect the printer to the station.

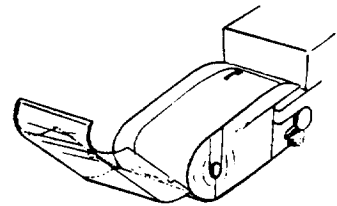

2 When using a battery pack (option)

- 6** Turn the power on and check that the release lever is lowered toward the front.
The buzzer will beep at this time indicating that there is no paper. Once the paper is installed this sound will stop.
- 7** Insert the paper straight into the printer. The paper will automatically come out of the output port.
If the paper comes out awry, release the release lever and straighten the paper with your finger.
Lower the release lever toward the front.
- 8** Close the paper holder cover until it catches in place.



Take care not to insert the paper roll upside down. Printing is not possible when paper is installed upside down.

7 - 3 Changing the Fuses in the Station



CAUTION Always turn the power switch off and unplug the power cord from the outlet before inspecting or changing fuses.

Specified fuse:

For AC 100 V/120 V area : Time-lag fuse 125 V 2 A, ϕ 5.2 x 20 mm
NAGASAWA ELECTRIC WORKS, LTD. Type
"SB2" or NIPPON SEISEN Type "FBT2".

For AC 230 V area : Time-lag fuse 250 V 1 A, ϕ 5.2 x 20 mm
NAGASAWA ELECTRIC WORKS, LTD. Type
"ES3-1000" or HAMAI DENKYU Type "TDI-1A".

A fuse may be blown if the power lamp do not light even though the power switch on the station is on (side marked |).

Unfasten the tabs on both sides of the fuse holder with the tip of a small flat-head screwdriver.

Remove the two fuses from the fuse holder. Check if either or both are blown and replace if necessary.

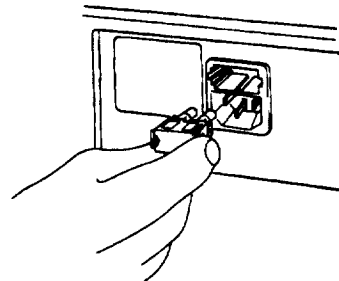
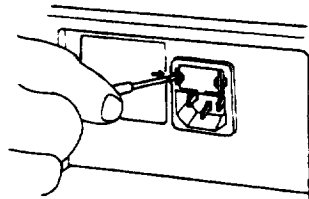

7 - 4 Cleaning the Forehead Rest

Be sure to clean the forehead rest periodically. Wipe the surface with a soft cloth or tissue paper dampened with commercially available lens cleaning liquid or absolute alcohol.

7 - 5 Cleaning the Measuring Window

The measuring window is dust-resistant glass. If any dust on the glass is visible from the patient side, use the blower provided to powerfully blow air several times to remove the dust. If the dust cannot be removed, wipe the glass with commercially available lens cleaning liquid or absolute alcohol.

 Do not press the dust-resistant glass too hard as it is thin and fragile.

7 - 6 Cleaning the Model Eye

Sometimes correct values cannot be obtained when measuring the model eye due to dust or fingerprints on the model eye's lens surface. If this occurs, gently wipe the lens surface with a clean and soft cotton cloth (such as gauze) dampened with a little commercially available cleaning solution or absolute alcohol. Take care not to scratch the lens surface. (Never use a handkerchief or degreased cotton wool.)

 Any microscopic scratch on the lens surface of the model eye may reduce the accuracy of measurement. Be careful not to bump the model eye against a hard object or drop it on the floor.

7 - 7 Cleaning the External Case

Do not use organic solvents such as alcohol, ether, or paint thinner on painted components, plastic components, or printed labels. Doing so may result in discoloration or peeling of printed characters. If the dirt is hard to remove, dampen a piece of gauze with a small amount of neutral detergent thinned with water, then wipe the dirty surface gently.

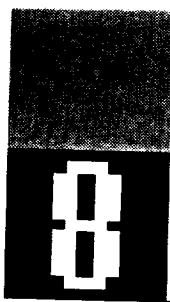

Troubleshooting

Check the following items before requesting repairs.

1 Measuring Unit

| Symptom | Check Point | Cause and Solution |
|---|---|---|
| Power lamp does not light even though Retinomax power is on. | If the battery pack is being used, it may be completely discharged. | If the Retinomax has just been purchased or has not been used for an extended period, the battery pack may be completely discharged. Charge the battery pack. |
| Measuring unit battery pack cannot be inserted. | Is the battery pack oriented correctly? | Check the procedure for inserting the battery pack. (→ P.18) |
| Keratometry cannot be made. Keratometry values are unstable. | Is surrounding external light affecting measurements? | Darken the room. Do not aim toward a window during measurement. Close the window shutters. |
| | Are the patient's eyelashes drooping? | Raise the eyelids. |
| Refractometry cannot be made. Refractometry values are unstable. | Are measurements out of range? Is there any foreign matter in the pupil obstructing the light? | Check in Retro Mode. |

2 Station

| Symptom | Check Point | Cause and Solution |
|--|---|---|
| The charge lamp flashes during charging/renewal. | Check according to the procedure given in "Notes on Charging the Battery Pack" in "2-5. Charging the Battery". (→ P.17) | If you think there is a problem, contact your nearest Nikon representative. |

3 Printer

| Symptom | Check Point | Cause and Solution |
|--|---|--|
| When the printer is connected to the station, power does not come on even though the printer's power switch is on. | Is the station power off without a battery pack inserted in the printer? | If no battery pack is installed in the printer, the printer will not function unless the station's power is on. Turn on the station's power. |
| | Is the printer connected properly to the station? | Connect the printer to the station properly. (→ P.13) |
| When operating the printer using a battery pack, the power lamp does not come on even though the printer's power switch is on. | Is the battery pack backwards? | Check the procedure for inserting the battery pack. (→ P.20) |
| | Is the battery lamp flashing green-yellow? | Charge the battery pack. |
| The printer's power lamp flashes. | Is the battery lamp alternately flashing green-yellow? | Charge the battery pack. |
| | Is paper installed properly? (The buzzer sounds in this case.) | Install the paper correctly. (→ P.58) |
| | Is the printer's release lever still released? | Lower the printer's release lever toward the front. |
| The buzzer keeps beeping. | Is paper installed properly? | Install the paper correctly. (→ P.58) |
| | Is there a problem with the RS-232C connection with the external device or a problem with the external device itself? | Check whether the connector has come loose and thoroughly read the instruction manual for the external device. |
| Nothing prints. | Are you using the specified printer paper? | Use the specified printer paper. |
| | Is the printer's release lever still released? | Lower the printer's release lever toward the front. |
| | Is the printer paper installed upside down? | Install the paper properly. (→ P.58) |
| The printer does not receive data even though measured data is being sent from the printer. | Is there an obstacle between the measuring unit and the printer? | Remove the obstacle or move to a location where the obstacle is not in the way. |
| | Do the ID numbers for the measuring unit and the printer match? | Check the output device settings (→ P.52) and the printer's dip switches (→ P.35) and make sure the ID numbers match. |
| Line spacing on the printout is too close together. Paper does not come out well. | Is the paper installed properly? | Install the paper properly. (→ P.58) |
| | Is the cover pressing against the paper? | Do not allow the paper holder knobs to put pressure on the paper by pushing in too far. |



Specifications

9 - 1 Measurement

● Refractometry

Measurement range: S + C: -18 to +23 Dp (measurement range for a VD value of 12)
C: 0 to -12 Dp or 0 to +12 Dp
AX: 1 to 180°

Minimum unit: S, C: 0.25D
AX: 1°

Minimum pupil diameter: \varnothing 2.5 mm

Measurement wavelength: Approx. 860 nm

● Keratometry

Measurement range: Corneal radius curvature: 5 to 11 mm
Corneal astigmatism: 0 to -12 Dp

Minimum unit: Corneal radius curvature: 0.01 mm
Corneal astigmatism: 0.12 Dp
Cylindrical axis: 1°

Measurement area: Center: 23°, \varnothing 3.2 (radius 8 mm)
Periphery: 50°, \varnothing 6.8 (radius 8 mm)

● Common Functions (Measurement Time and Mode)

| | |
|--------------------------------|---|
| R-K mode: | Continuous measurement: R/K Single measurement: R, K |
| Measurement time: | Refractometry: Time to acquire one measurement: 0.01 sec. Keratometry: Time to acquire one measurement: 0.033 sec. Measurement time during continuous measurement: R/K: 0.25 sec/measurement at continuous measurement R: 0.12 sec/measurement at single measurement K: 0.17 sec/measurement at single measurement |
| Measurement mode: | Auto measurement: Auto start, auto stop Continuous measurement: Continuous measurements after auto start Quick measurement: Measurement is given priority over fogging to decrease the time required for refractometry. |
| Fixation chart: | Picture target |
| Fixation chart brightness: | 2-level switchable illumination |
| Mire ring: | 18-dot LED, ϕ 2.6 (radius 8 mm) |
| Retro illumination: | Pressing the RETRO key turns off exterior illumination of the eye and causes alignment marks and other displays to disappear allowing retro illumination of the patient's eye for observation of cataracts, scratches, etc. |
| Corneal vertex distance: | 0, 12, 13.5, 13.75, 15, 16 mm |
| Left/right eye identification: | Switchable between auto and manual |

● Measurement Accuracy

| | |
|----------------------------------|---|
| Spherical and cylindrical power: | ± 0.25 D or less for 0 to ± 10 D ± 0.5 D or less for less than -10 D and larger than $+10$ D |
| Radius curvature (center): | ± 0.02 mm or less |
| Radius curvature (periphery): | ± 0.05 mm or less |

9 - 2 Measuring unit and Miscellaneous

| | |
|----------------------------|---|
| Measuring unit dimensions: | 163 (W) x 236 (D) x 226 (H) mm |
| Weight: | 1020 g (no battery) 1200 g (including battery) |
| Real-time clock: | Built-in real-time clock for printing the year, month, day, hour and minute |
| Monitor: | 0.6-inch monochrome viewfinder |
| Power saving system: | Enters sleep mode if no keys are pressed for three minutes |
| Melody sound: | Yes |
| Printer message: | Yes |
| Password input: | Yes |

● Station

| | |
|--------------------|--|
| Battery charge: | Automatic charge, manual charge |
| Power consumption: | 100 VA |
| Fuses: | For AC 100 V/120 V area : Time-lag fuse 125 V 2 A, ϕ 5.2 x 20 mm NAGASAWA ELECTRIC WORKS, LTD. Type "SB2" or NIPPON SEISEN Type "FBT2". For AC 230 V area : Time-lag fuse 250 V 1 A, ϕ 5.2 x 20 mm NAGASAWA ELECTRIC WORKS, LTD. Type "ES3-1000" or HAMAI DENKYU Type "TDI-1A". |
| Weight: | 1.25 Kg |
| Dimensions: | 179 (W) x 105 (H) x 257 (D) mm |

● Printer

| | |
|----------------------|---|
| Printer paper width: | 58 mm |
| Power: | Power supplied from station (when connected to station) or battery driven (when battery is inserted and printer is off the station) |
| Battery: | Nickel-hydrogen battery (DURACELL DR10) Operational time: Approx. 1 hour per full charge Charge time: Approx. 1.5 hours |
| Input: | External printer, infrared communications |
| Output: | External tester or external computer RS-232C standard interface (external connector) |
| Weight: | 770 g (with paper but no battery) |
| Dimensions: | 93 (W) x 77 (H) x 266 (D) mm |
| Eye print diagram: | Yes |

● **Battery Pack**

Battery type: Nickel-hydrogen battery (DURACELL DR10)
Nominal voltage: 6 V DC
Nominal capacity: 1500 mAh
Weight: 180 g
Dimensions: 46 (W) x 18.2 (H) x 89.3 (D) mm

Classification of device
(EN60825-1 : 1994): Class 1 LED product

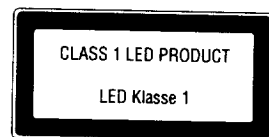

Wavelength of LED: 855 to 870 nm
Radiation power: 245 μ Wmax
Chopped frequency: 400 to 600 Hz



.)

.

.

.)

.

.

.)